

Impact of Real Case Transmission Systems Constraints on Wind Power Operation

François Vallée – Olivier Deblecker – Jacques Lobry
*Electrical Engineering Department, Faculté Polytechnique de Mons
Belgium*

1. Introduction

Each investment scenario on a given electrical transmission system must ensure a quality service at the lowest cost (services continuity, system exploitation). In order to answer this major issue of modern networks, it is therefore necessary to compute a faithful representation of the transmission system. In that way, statistical analysis by means of a Monte Carlo simulation (Billinton et al., 1996) – (Papaefthymiou et al., 2006) permits electrical system modeling via the simulation of a large set of representative states. Consequently, Monte Carlo studies permit to obtain coherent exploitation cost and reliability indices for each studied network.

In a near future, stochastic electrical production, and more specially wind generation, is expected to play an important role in power systems. It is therefore imperative to study the impact of this decentralized production source on transmission systems operation constraints. Actually, adequacy studies taking into account wind generation have been extensively developed for the HLI level (load covering with always available transmission system) (Billinton & Bai, 2004) – (Wangdee & Billinton, 2006). From the transmission system point of view, a first reliability study taking into account transmission constraints has been introduced in order to evaluate transmission reinforcement planning associated to large scale wind farms integration (Billinton & Wangdee, 2007). However, that approach was not feasible using normal personal computers and was requiring the use of multiprocessors. Moreover, that proposed study was not considering eventual operation constraints (fatal production, nuclear or high powered thermal units that the producer does not want to stop during the nights...) on classical generation parks.

In the present paper, as reliability and reinforcement analysis are long term studies, stochastic wind generation models are proposed and introduced into an HLII (bulk power system) (Billinton & Wangdee, 2007) – (Allan & Billinton, 2000) non sequential Monte Carlo simulation tool. Thanks to the utilization of that non sequential approach, computing requirements are reduced without worsening the precision of the obtained global indices. Moreover, classical machines and transmission constraints can also be simultaneously considered when facing an increased penetration of wind generation. Therefore, it is believed that the proposed tool will assist system planners and transmission system operators to qualitatively assess the system impact of wind production and to provide adequate input for the managerial decision process in presence of increased wind penetration.

Source: Wind Power, Book edited by: S. M. Mueen,
ISBN 978-953-7619-81-7, pp. 558, June 2010, INTECH, Croatia, downloaded from SCIYO.COM

This chapter is organized as follows. In a first part, the methodology used to efficiently introduce wind generation in the HLII simulation tool is explained. Then, hypotheses based on real observations are made in order to introduce wind generation into an economic dispatch with classical parks and transmission constraints. In a third section, wind impact on reliability and reinforcement analysis for transmission systems is computed for an academic test system: the *Ray Billinton Test System (RBTS)* (Billinton et al., 1989). In the following paragraph, the developed simulation tool is applied to the real case Belgian transmission system and points out several reinforcement scenarii in order to safely integrate offshore wind generation. Finally, a conclusion is drawn and points out the major results collected thanks to the introduction of wind generation into HLII analysis taking into account transmission systems constraints.

2. Presentation of existing HLII Monte Carlo simulation tool: Scanner©

2.1 System states generation

The simulation tool Scanner© is the property of *Tractebel Engineering (Gaz de France – Suez)*. Its main objective is to provide technical and economical analysis of development alternatives on a given electrical system. In that way, acceptance (or rejection) criterion is generally based on the following assessment: **“Each investment scenario must ensure a quality service (system exploitation, healthy behavior when facing unexpected outages, continuity of services...) at the lowest cost”**. To answer this issue, a complete analysis of the given transmission system (HLII) is required. Consequently, Monte Carlo simulation tool Scanner© analyses the system evolution as a set of static representative states.

To generate the different system states, the model loops on the 52 weeks of the year (see Fig. 1). During each week, a given number (defined by the user according to the required accuracy on the calculated indices) of system states are generated by mean of the following procedure:

- *Definition of the system state hour during the considered week*: random generation by use of uniformly distributed numbers on the following fixed interval [0, 168] (168 hours during a week);
- *For each generated hour*: uniformly distributed random numbers (V) on the interval [0, 1] are sampled for each element (classical generation units, transformers, lines...) in order to decide its operation state, using the following procedure (Billinton et al., 1996):
If $V \leq$ Forced Outage Rate (FOR) (Billinton et al., 1996), the element is considered as unavailable;
If $V > FOR$, the element is considered as fully available;

Concerning the hourly load at each node of the system, its determination is based on the use of the annual peak load value at the considered node; this last one being combined with two modulation diagrams:

- *Diagram of weekly modulation of the annual peak load*: this last one permits to calculate the peak load of the actual week on the basis of the annual peak load value for the considered node. This diagram contains thus 52 modulation rates of the annual peak load value;
- *Diagram of the hourly modulation of the weekly peak load*: it permits to calculate the hourly load for each hour of the week. This diagram contains thus 24 modulation rates of the weekly peak load value.

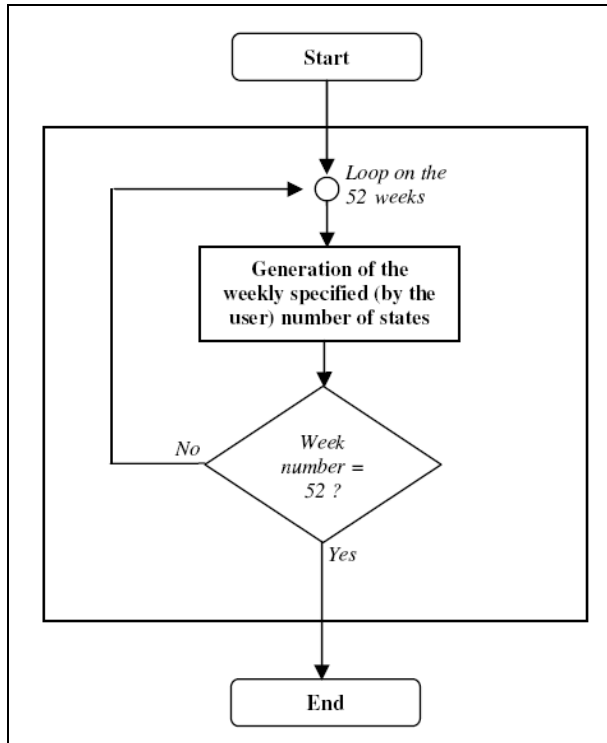

Fig. 1. Algorithm of the system states generation procedure.

The introduction of the load in the investigated simulation tool can thus be considered as 'sequential' (whereas the generation of element states is non sequential). Indeed, thanks to the applied methodology, no random sampling is used to generate the hourly load at each node of the system. More simply, the program just considers, in the weekly modulation diagram, the rate corresponding to the actual week during the simulation process (Fig.1); then, it associates to the generated weekly peak load the rate of the hourly modulation diagram corresponding to the investigated hour of the day.

Finally, as the consumption during one week can change from one day to the other (days of the week, Saturday or Sunday), several diagrams of hourly modulation can be associated to each node during one week. Moreover, seasonal aspects can also be taken into account by defining periods during the year and by changing the set of hourly modulation diagrams associated to each node from one period to the other.

Fig. 2.a illustrates the load behavior during one year (based on a Belgian real case for the year 2000 (Buyse, 2004)) for an annual peak load of 185MW at the considered node. In Fig. 2.b, a zoom is made on one week of the year for the same node and illustrates the consideration of possible change of consumption from one day to the other inside the week.

2.2 System states analysis

Each generated system state must then be analyzed. To proceed to this stage of the process, three steps are consecutively realized for each system state:

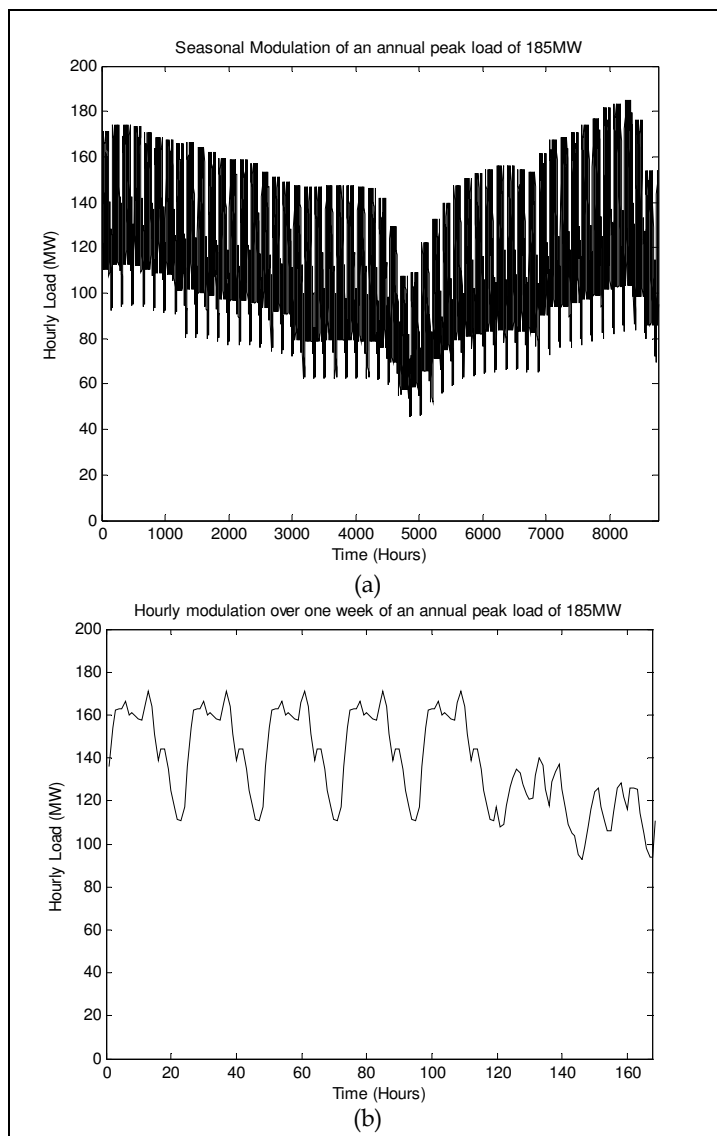

Fig. 2. Seasonal modulation for 185MW peak load value (a) and hourly modulation over one week of the year for the same peak value (b) based on a Belgian real case (Buyse, 2004)

1. *Economic dispatch*: this last one is based on the available production units and is done **without considering transmission facilities availability**. The objective is thus to ensure, at the lowest cost, the hourly load with the available production. Note that **the economic dispatch is taking into account possible constraints on classical units operation**. Consequently, several types of production parks are considered in Scanner© among which:

- Hydraulic production and pumping stations: they are considered as zero cost production in the algorithm and are managed at a weekly time scale;
 - Thermal production: three types of constraints are considered for this kind of production. Firstly, **technical minima** (threshold under which the producer does not want to run, for technical reasons, its unit) can be considered. Secondly, **forced units** can be defined by the user. Those entities represent units (such as cogeneration) that have a threshold over which they must always operate when they are available. Finally, in order to take into account high powered thermal or nuclear units that the producer does not want to stop during the week, those machines are considered as **long term units**. They are managed at the weekly time scale and must always run at their technical minimum value during the actual week when they are needed to cover the reference peak consumptions of the week (in the other case, they are supposed entirely unavailable during the entire week). Finally, the algorithm conducted during the economic dispatch proceeds as follows. In a first step, hydraulic production is used to cover the load (following the orders of the weekly management). Then, technical minimum values of forced and long term (if they are required to cover the reference peak loads during the week) thermal units are considered to satisfy the load (minus hydraulic production). Finally, an economic dispatch of the thermal production (minus the technical minimum values of already considered forced and long term units) is realized to cover the remaining load.
2. *DC Load Flow*: this step realizes the computation of active power flows in transmission lines without considering reactive power.
In order to solve the DC load flow problem, generated active powers calculated during the economic dispatch are introduced at the connection nodes of the concerned machines. Moreover, the generated hourly consumption for the current state is also taken into account at the required nodes. DC load flow then computes active power flows over the transmission system and permits to take into account transmission constraints. In case of line overflow, step 3 is started. On the opposite, if the optimal solution does not involve overloaded lines, this next step is avoided.
 3. *Production rescheduling or load shedding*: this step is only started if the optimal solution of the economic dispatch leads to overloaded lines during step 2. In that case, the solution is "disoptimized" by modifying the production plan (production rescheduling). If this first stage is not sufficient to relieve the overflows, a load shedding procedure is then started in order to limit active power flows.

Finally, note that those three presented steps are repeated to analyze each generated system state.

2.3 Calculated indices and productions

Thanks to the Scanner© tool, it is possible to compute several reliability indices for the studied system.

Among them, the most significant ones are certainly the *Loss of Load Expectation* (LOLE in hours/year) (Billinton et al., 1996) (generation system index calculated without considering transmission facilities) and the number of hours (per year) of load shedding (due to transmission overflows). Moreover, hours of overflows are also computed for each transmission line in order to point out the weakest points of the system.

Next to those indices, the annual cost of production (with and without considering elements unavailability) is computed. Moreover, mean production and annual energy generated by each classical unit can also be calculated. Finally, histograms of production can be printed out in order to analyze the utilization of each classical unit.

3. Wind generation modelling for HLII non sequential Monte Carlo simulation

Scanner© does not currently take into account wind production in its algorithm (as well as for the system states generation as for the analysis of those states). However, given the major increase of wind penetration in some countries (like Germany) (Ernst, 2005), this variable kind of production can no more be neglected in technical (and economical) transmission system analysis. Therefore, in the present work, wind production has been implemented in the simulation tool Scanner©. In order to achieve that step, modifications related to the introduction of wind have to impact both major stages of the simulation process: **system states generation and the analysis of these states**.

3.1 Introduction of wind power in system states generation

Before taking into account wind power in the system states generation process, the user has to define three entities related to wind production:

- **Entity 1 (wind parks):** each wind park is practically characterized by its installed capacity, production cost, *FOR* of one turbine, associated wind speed regime and P-W conversion characteristic (Vallée et al., 2008);
- **Entity 2 (wind speed regimes):** they are characterized by *Cumulative Distribution Functions (CDF)* representing different statistical behaviors for wind speed in the studied territory. Those *CDF* can be classical *Weibull* distributions (Vallée et al., 2008) or arbitrary ones. In the latter case, distributions are linearly interpolated in the program on the joint basis of the wind speed step and probability intervals defined by the user. Finally, a name is associated to each different wind speed regime and the user can freely associate a wind speed regime to a wind park by defining the name of this wind speed regime in the characteristics of the wind park (cf. entity 1);
- **Entity 3 (P-W conversion characteristics):** they transform wind speed into production. Practically, the conversion characteristics are linearly interpolated on the joint basis of the wind speed step and the power intervals defined by the user. An example of the linear interpolation related to a classical doubly-fed asynchronous generation structure (Al Aimani, 2004) is given in Fig. 3. Note that a single conversion characteristic is practically applied to an entire park. Finally, the link between wind parks and associated P-W conversion characteristics is made identically as for the wind speed regime case (cf. entity 2).

Once the three basic kinds of entities related to wind production have been defined by the user, the generation process can be started. The algorithm, executed when wind generation is concerned, is presented in Fig. 4. The applied methodology is the following one. During each generated system state, a first loop is started over the defined wind speed regimes and a wind speed per defined characteristic is generated by use of the classical inverse transform method (Vallée et al., 2008). By applying this methodology, it is supposed that wind parks subject to the same wind speed regime are entirely correlated. Based on (Vallée et al., 2008) and (Papaefthymiou, 2006), this approach will lead to the most fluctuating wind power and,

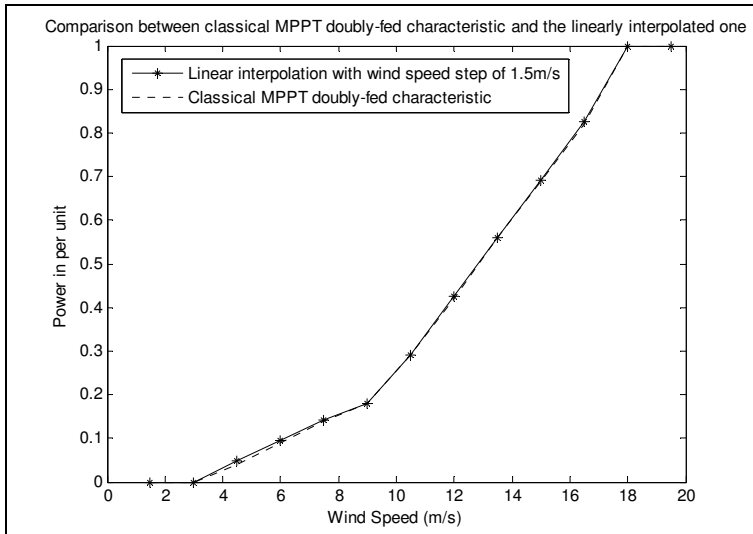

Fig. 3. Comparison between classical *Maximum Power Point Tracking (MPPT)* conversion characteristic (Al Aimani, 2004) and the interpolated one (1.5m/s wind speed step) in p. u.

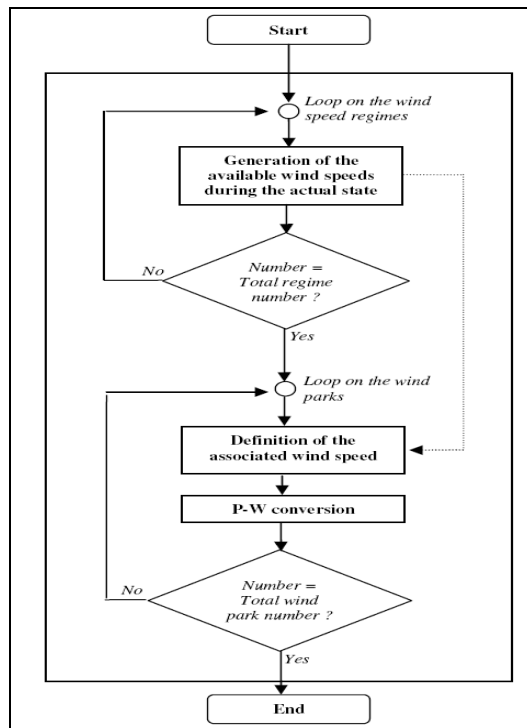

Fig. 4. Algorithm of wind generation during each system state

thus, to the worst case for adequacy studies. Finally, a second loop is made over the defined wind parks. For each wind park, the associated wind speed is decided by taking the one sampled for the wind regime associated to the considered wind park. Then, each wind park production is calculated by introducing the sampled wind speeds in the associated P-W characteristics. Practically, P-W characteristics will be introduced in per unit and the real wind productions will be obtained by multiplying per unit quantities by the *Maximal Available Wind Park Capacity (MAWPC)*. The *MAWPC* is related to the *Installed Wind Park Capacity (IWPC)* by:

$$MAWPC = (1 - FOR) \cdot IWPC \quad (1)$$

By applying (1), possible outages of wind turbines inside a park are considered. Equation (1) supposes that a wind park is made of a sufficiently large number of turbines to consider that the FOR related to one turbine is the same as the one existing for the entire park. This hypothesis is well funded as high powered wind parks connected to transmission systems will be practically composed of a large number of turbines.

Finally, note that the wind production generation process is started back for each system state. Consequently, a *Generated Wind Production Distribution* can be plotted for each wind park 'i'.

Fig. 5 illustrates the obtained wind production distribution for one 8 MW wind park subject to a *Weibull* wind speed regime (with scale parameter $A = 5.25$ and shape parameter $B = 3.55$) and using the P-W conversion characteristic of Fig. 3. This production distribution is logically concentrated over limited wind production as the considered wind speed parameters were quite low in the present case.

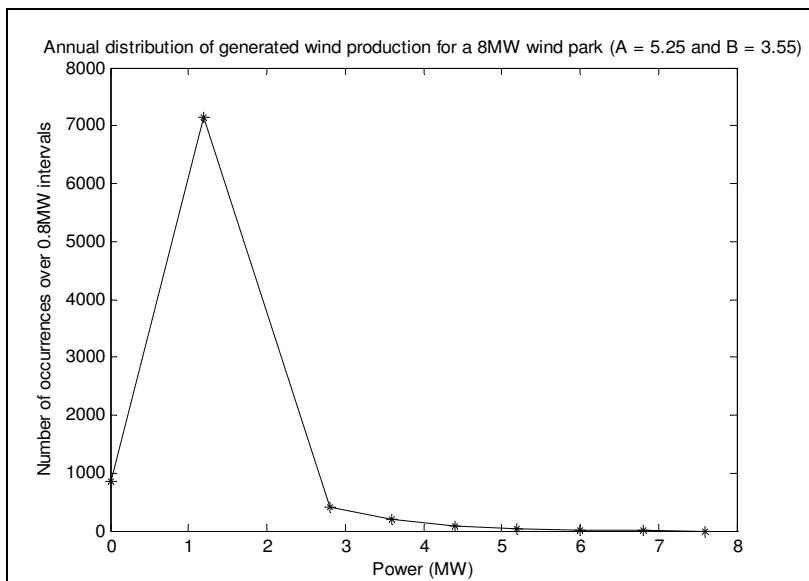

Fig. 5. Simulated annual distribution of generated wind production for a 8 MW wind park ($A = 5.25$ and $B = 3.55$)

3.2 Introduction of wind power in system states analysis

The *Generated Wind Production* (GWP_i) represents thus, for each defined park 'i', the sampled wind power during the simulated system state. This production must then be taken into account in the system state analysis.

The introduction of wind production into the economic dispatch of Scanner© has so been based on several hypotheses:

- **Hypothesis 1:** it has been considered that wind power was not accurately predictable at the weekly time scale (Ernst, 2005) and could therefore not impact the management of hydraulic and long term thermal (nuclear) units. Those classical units are thus still processed at the weekly time scale without wind impact;
- **Hypothesis 2:** wind power is considered as a must run production with zero cost. This hypothesis is based on the multiple encouraging policies that generally support wind production (Mackensen et al., 2007) - (Maupas, 2006). Consequently, in the economic dispatch, wind production will be directly considered **after** the technical constraints related to **forced and 'having to run' long term thermal units**;
- **Hypothesis 3:** in case of increased wind penetration, the *Transmission System Operator* (TSO) can be forced (like it has already been the case in some German places (Sacharowitz, 2004)) to cut some wind production when facing classical machines constraints (Sacharowitz, 2004). In the proposed algorithm, when encountering such situations, wind production is decreased, for each wind park, proportionally to its available generated power.

The existence of some transmission system operation constraints can thus lead to a reduction of the real produced wind power. Therefore, in the developed algorithm, two quantities related to wind production have been defined **for each wind park**:

- *Real Wind Production* (RWP): it represents the real produced wind power after having taken into account the economic dispatch. A single RWP_i value is associated to each wind park 'i';
- *Lost Wind Production* (LWP): it defines the difference between the generated wind production and the real produced one for each considered wind park. A single LWP_i value is thus calculated for each wind park 'i';

The algorithm, implemented in order to take into account wind production in the economic dispatch associated to each generated system state, is described in Fig. 6.

Based on hypotheses 1 and 2, wind production is thus used to cover the remaining load after that hydraulic production and technical minima of forced and 'must run' long term thermal parks have been taken into account. If this remaining load L_1 is equal to zero, all the hourly load has already been covered before considering wind generation. In that case, real transmitted wind production RWP_i is set to zero for each wind park 'i' and their associated lost wind production LWP_i equals their initially generated wind power GWP_i during the considered system state.

On the other hand, if the remaining load L_1 is greater than zero, *Global Generated Wind Production* ($GGWP$) is taken into account before the remaining classical thermal production (without constraints) and is entirely taken off from load L_1 . If the obtained load value L_2 (after consideration of hydraulic production, of forced and 'must run' long term thermal parks technical minima and of wind production) is greater or equal to zero, RWP_i equals the generated wind production GWP_i for each park 'i' and LWP_i is set to zero (and the classical economic dispatch is pursued). In the case of remaining load value L_2 is negative, it is then

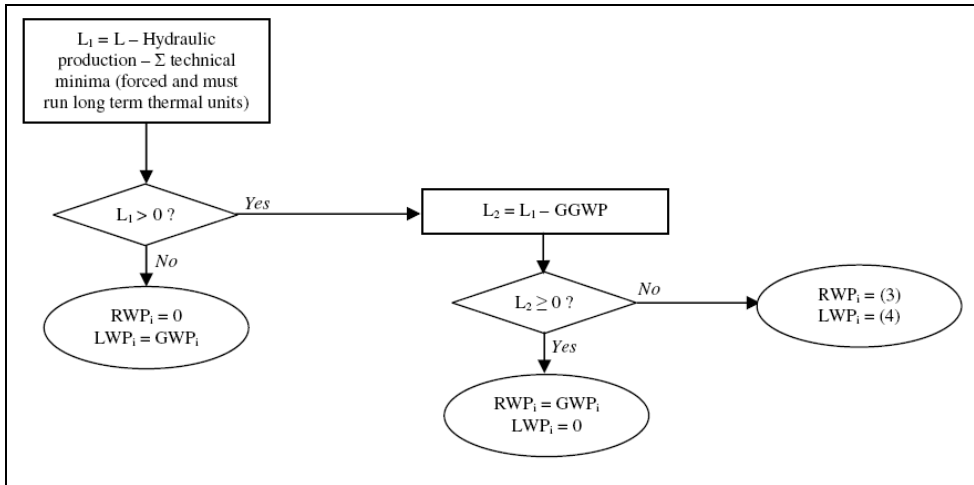

Fig. 6. Algorithm implemented in order to take into account wind production for the economic dispatch of each generated system state

necessary to reduce real transmitted wind production by following hypothesis 3. In order to apply this reduction of wind power, the remaining load L_1 (before introduction of the generated wind production) is taken back. RWP_i and LWP_i associated to each defined wind park 'i' are obtained via equations (2), (3) and (4):

$$GGWP = \sum_{i=1}^N GWP_i \tag{2}$$

$$RWP_i = \frac{GWP_i \cdot L_1}{GGWP} \tag{3}$$

$$LWP_i = GWP_i - RWP_i \tag{4}$$

At the end of the actual system state economic dispatch, real and lost wind productions (RWP_i and LWP_i) are thus defined for each wind park. In order to take into account wind production impact over transmission constraints, calculated RWP_i are then injected at the adequate nodes and the DC load Flow (section 2.2) is launched. If no line overflows are recorded for the computed system state, RWP_i and LWP_i stay unchanged for each wind park 'i'. On the opposite, in case of overloaded lines, the algorithm of rescheduling/load shedding (section 2.2) is used and RWP_i et LWP_i can have to be modified in order to ensure a safe behavior of the transmission system.

The system state analysis leads thus now to the computation of RWP_i and LWP_i for each wind park 'i'. This process is set back for each generated system state. Consequently, at the end of the Monte Carlo simulation, histograms of GWP_i , RWP_i and LWP_i can be drawn for each defined wind park 'i'. Moreover, mean values of generated (GWP_i) and real (RWP_i) exchanged wind powers are calculated, for each wind park, in order to point out the impact of transmission system constraints on wind production. Also note that reliability indices defined in section 2.3 are now taking into account wind production.

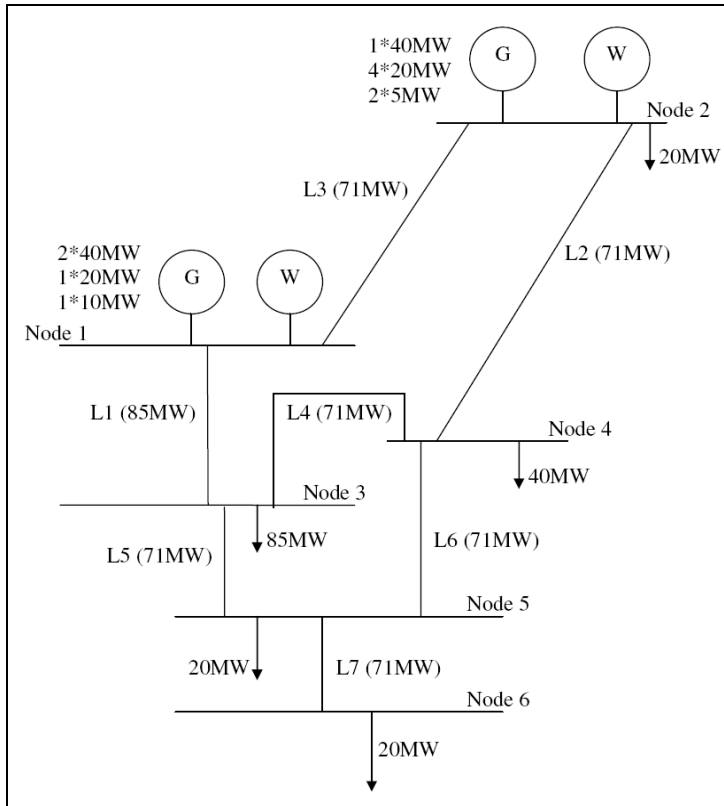

Fig. 7. Implemented version of the *RBTS*

4. Simulations results on a modified *RBTS* test system

4.1 Wind parks introduced in *RBTS* generation nodes (Billinton et al., 1989)

In order to point out wind generation behavior in modern transmission systems management, a slightly modified version of the academic *RBTS* test system (Billinton et al., 1989) has been considered. The implemented version of *RBTS* is described in Fig. 7 and differs from the original one for some aspects:

- Peak load is always 185MW but the weekly and hourly modulation diagrams have been based on the Belgian real case (Buyse, 2004) given in Fig. 2;
- Wind generation (48MW) is firstly introduced in generation nodes 1 (24MW) and 2 (24MW) by following the data given in tables 2 and 3. Wind speed regimes are supposed to be *Weibull* ones but differ from node 1 to 2. P-W conversion characteristic is the one depicted in Fig. 3;
- The *RBTS* number of lines has been reduced from 9 (Billinton et al., 1989) to 7 in the present simulation. Indeed, both parallel lines between nodes 1-3 and nodes 2-4 (Billinton et al., 1989) are suppressed in order to point out the interest of Scanner© tool in showing the weak points of the studied system;

- Compared to the initial version of the RBTS (Billinton et al., 1989), operation constraints can be added, here, for classical parks (section 2.2). Consequently, more realistic system states management can be studied in the present case;
- No FOR is considered for lines and transformers as their availability is not under the scope of the present study. On the other hand, transmission constraints are taken into account;
- FOR is considered for classical production parks and for wind generation.

	Wind regime	A	B
Node 1	Weibull	7.10	2.85
Node 2	Weibull	9.95	2.75

Table 1. Wind speed regimes considered at nodes 1 and 2 of the RBTS.

	Installed capacity (MW)	Connection node
Wind park 1	8	Node 1
Wind park 2	6	Node 1
Wind park 3	12	Node 2
Wind park 4	1	Node 1
Wind park 5	3	Node 2
Wind park 6	4	Node 1
Wind park 7	5	Node 2
Wind park 8	4	Node 2
Wind park 9	5	Node 1

Table 2. Wind generation considered for the modified RBTS

In order to face wind generation and transmission system operation constraints, two cases have been simulated:

- *Case 1*: no operation constraints are considered for the classical park: all parks are supposed to be thermal ones without technical minimum value;
- *Case 2*: operation constraints are associated to the defined classical parks. Here, the sum of technical minima is supposed to be 75MW. This represents almost 30% of the installed classical capacity (240MW) in reference to the Belgian real case (Buyse, 2004). Those 75MW are divided in nuclear (30MW), long term thermal (30MW) and forced parks (15MW).

Both cases have been firstly investigated for a 48MW installed wind capacity (table 2). With this first wind penetration, table 3 summarizes real transmitted annual wind energy for each park. It can clearly be observed that, with this reduced penetration, classical park operation constraints have a limited impact on wind as collected energies are similar in both investigated cases.

Moreover, Fig. 8 compares RWP for wind park 1 in both investigated cases and clearly confirms an identical behavior of this wind park with or without classical operating constraints (this result can be extended to all the other considered wind parks). For information, GWP (identical in both cases as wind data are the same from one simulation scheme to the other) is also plotted and points out that all available wind power is transmitted in the system when wind penetration is low. Finally, note that, due to the

limited transfer capacity of line *L1*, 340 annual hours of load shedding (node 3) are computed here but have no impact on wind power. In fact, as computed load shedding situations are quite seldom and not severe in the present case, wind generation is not modified by transmission constraints. Consequently, with the version of *RBTS* presented in Fig. 7, only classical units operation constraints can have an impact on wind generation.

	Case 1	Case 2
Annual energy wind park 1 (GWh/y)	7.5	7.5
Annual energy wind park 2 (GWh/y)	5.5	5.5
Annual energy wind park 3 (GWh/y)	25.0	25.0
Annual energy wind park 4 (GWh/y)	0.9	0.9
Annual energy wind park 5 (GWh/y)	6.3	6.3
Annual energy wind park 6 (GWh/y)	3.7	3.7
Annual energy wind park 7 (GWh/y)	10.4	10.4
Annual energy wind park 8 (GWh/y)	8.2	8.2
Annual energy wind park 9 (GWh/y)	4.8	4.8

Table 3. Annual wind energies with (case 2) and without (case 1) classical park operation constraints for 48MW installed wind capacity

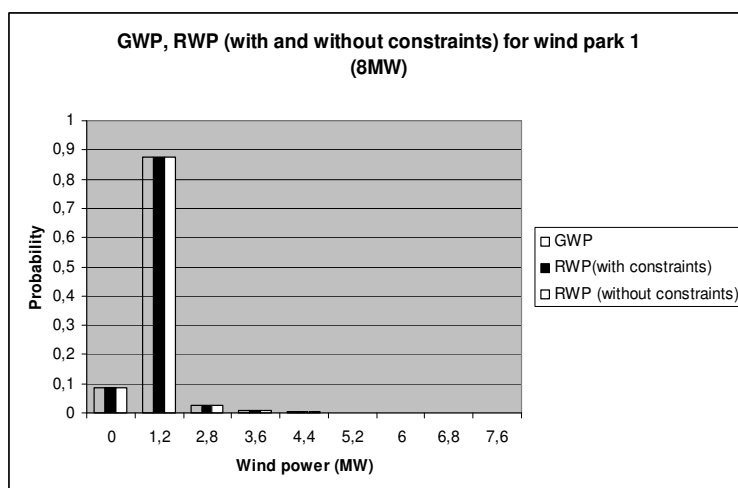

Fig. 8. *GWP* and *RWP* for wind park 1 (8MW) with and without classical operating constraints

A second simulation has then been investigated by doubling wind production at node 2 to 48MW and by setting to zero the one of node 1. Again, simulations have been realized with and without operation constraints on classical parks (cases 1 and 2). In table 4, it can be concluded that, if all wind production is installed in node 2 (greater wind speeds; see Table 1), some situations of wind power excess can be computed. By comparing the results of tables 3 and 4, it can thus be concluded that, with the same global wind penetration, smoothing effects due to wind generation dispersion can have a positive effect on the electrical transmission system management.

	Case 1	Case 2
Annual energy wind park 1 (GWh/y)	0	0
Annual energy wind park 2 (GWh/y)	0	0
Annual energy wind park 3 (GWh/y)	49.2	48.8
Annual energy wind park 4 (GWh/y)	0	0
Annual energy wind park 5 (GWh/y)	12.4	12.3
Annual energy wind park 6 (GWh/y)	0	0
Annual energy wind park 7 (GWh/y)	20.5	20.3
Annual energy wind park 8 (GWh/y)	16.2	16.1
Annual energy wind park 9 (GWh/y)	0.0	0.0

Table 4. Annual wind energies with (case 2) and without (case 1) classical park operation constraints for 48MW installed wind capacity at node 2 (only)

4.2 Adequate repartition of wind parks in the transmission system

In the previous paragraph, as transmission line capacities were sufficiently high, only classical parks operation constraints had an impact on wind generation. In order to also take into account transmission lines constraints, the *RBTS* test system has been voluntarily weakened by reducing the capacity of line *L1* (Fig. 7) to 40 MW.

Fig. 9 presents the simulation results collected in that case with the wind parks defined in table 2 (48 MW installed in nodes 1 and 2). If compared with table 3 (case 2), it can be observed that the power of all wind parks connected to node 1 must be reduced due to the limited capacity of *L1*.

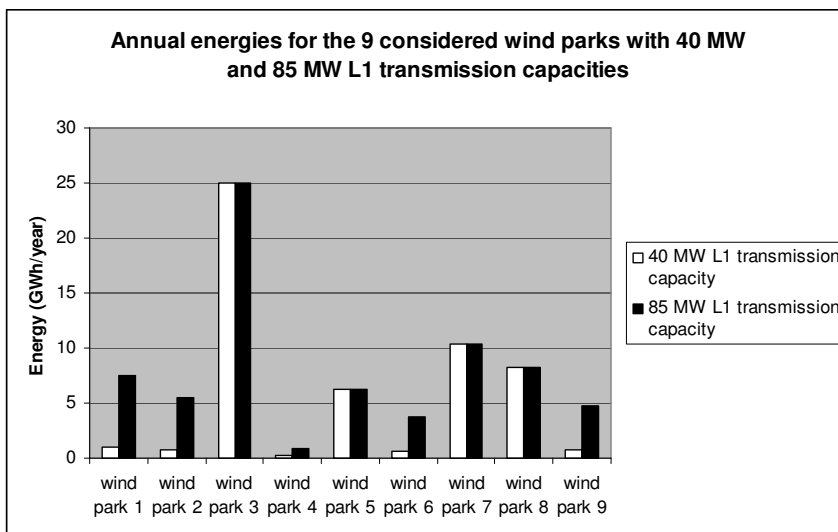

Fig. 9. Annual energy (GWh/year) for the 9 considered wind parks with 40 MW (white) and 85 MW (black) *L1* transmission capacities

In the case of a weakened transmission system, the connection nodes of wind parks take thus a major importance. Indeed, if the considered 48MW of wind generation are now

distributed between nodes 2 and 4 (see table 5), the limited transmission capacity of *L1* does no more impact wind power and this last one can be entirely transferred in the network (see table 6). This complete use of wind production was not feasible when some of the defined wind parks (24MW) were directly connected at *L1* (via node 1; see Table 2 and Fig. 9).

	Installed capacity (MW)	Connection node
Wind park 1	8	Node 4
Wind park 2	6	Node 4
Wind park 3	12	Node 2
Wind park 4	1	Node 4
Wind park 5	3	Node 2
Wind park 6	4	Node 4
Wind park 7	5	Node 2
Wind park 8	4	Node 2
Wind park 9	5	Node 4

Table 5. Wind generation considered for the modified *RBTS* test system

Annual energy wind park 1 (GWh/y)	7.5
Annual energy wind park 2 (GWh/y)	5.5
Annual energy wind park 3 (GWh/y)	25.0
Annual energy wind park 4 (GWh/y)	0.9
Annual energy wind park 5 (GWh/y)	6.3
Annual energy wind park 6 (GWh/y)	3.7
Annual energy wind park 7 (GWh/y)	10.4
Annual energy wind park 8 (GWh/y)	8.2
Annual energy wind park 9 (GWh/y)	4.8

Table 6. Annual wind energy for wind parks located in nodes 2 and 4 with limited transmission capacity of *L1* (40MW)

This result points out the utility of the developed tool in order to improve the management of wind generation. Indeed, thanks to the proposed software, the transmission system operator will now be able, not only, to quantify the maximal wind penetration in a given network, but also, to propose an adequate distribution of wind parks connection nodes. However, for this last point, note that environmental concerns for the establishment of wind parks must still be taken into account.

5. Wind generation management in a real case transmission system

In order to point the utility of the developed tool for investments studies in modern networks, we have applied the proposed program to the real case Belgian transmission system. The major issue for this network concerns the large scale integration of offshore wind power. In that way, two projects (for an installed capacity of 630 MW) are actually built in the North Sea and are going to lead to the connection of respectively 300 MW at the 150 kV Slijkens connection node and of 330 MW at the 150 kV Zeebrugge node. Initially, the transmission capacity from Slijkens and Zeebrugge towards Brugge is highly sufficient as it reaches 800 MW. However, as illustrated in Fig. 10 (Van Roy et al., 2003), the integration of

offshore wind power associated with the importation of electricity from France towards the Netherlands can lead to the apparition of congestions between Rodenhuiuze (Gent) and Heimolen (Antwerpen). Such a result is confirmed with our developed simulation tool as an increase of congestion hours over the line between Rodenhuiuze and Heimolen can be observed in Fig. 11 when 200 MW of wind power are installed in the North Sea and that 1 GW is imported from France towards the Netherlands. Simultaneously, the increase of installed offshore wind power does not change the amount of critical hours over the Slijkens - Brugge and Zeebrugge - Brugge lines. This last result confirms thus that the major issue of Belgian wind integration is mainly related to possible congestion hours inside the country (between Gent and Antwerpen).

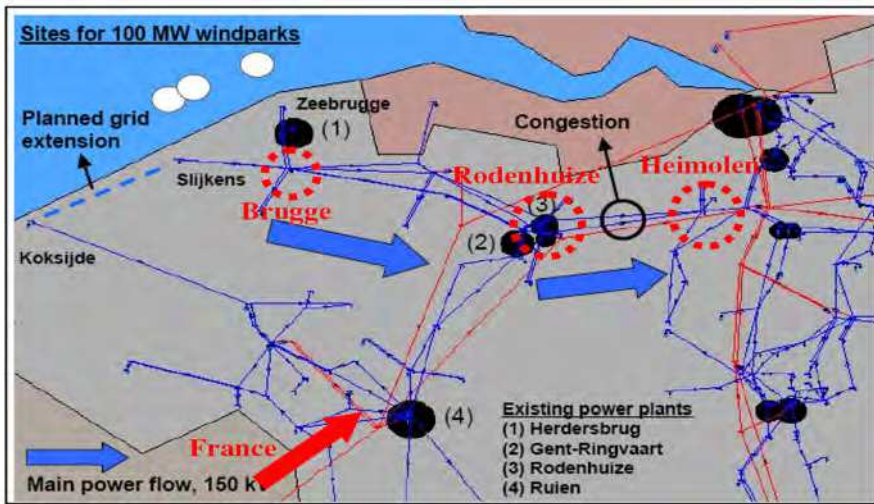

Fig. 10. Major active power flows over the Belgian transmission system after the large scale integration of offshore wind power

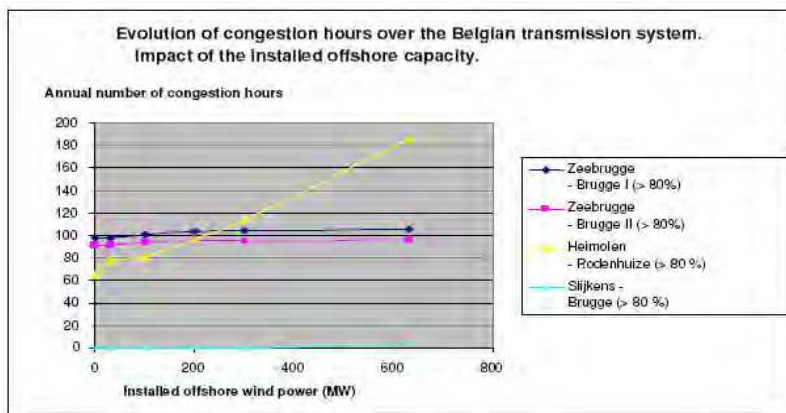

Fig. 11. Evolution of congestion hours over major transmission lines in the Belgian high voltage system. Impact of the installed offshore capacity

In order to improve the offshore wind power integration and to consequently reduce the number of congestion hours over the Rodenhuize-Heimolen line, a grid extension of 150 MW between Koksijde and Slijkens was proposed (dashed curve in Fig. 10). With this new 150 kV line, simulation results (Fig. 12) clearly confirm a reduction of congestion hours between Gent and Antwerpen when the importation level is limited (and that the installed offshore wind power reaches 630 MW). However, after an increase to 2 GW of the electricity

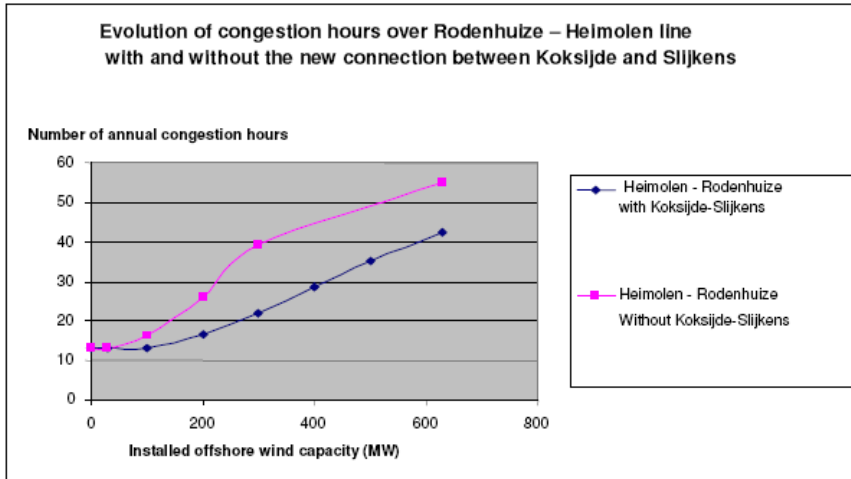

Fig. 12. Evolution of congestion hours between Rodenhuize and Heimolen with and without the added connection Koksijde-Slijkens (importation level of 1 GW and 630 MW installed offshore wind power)

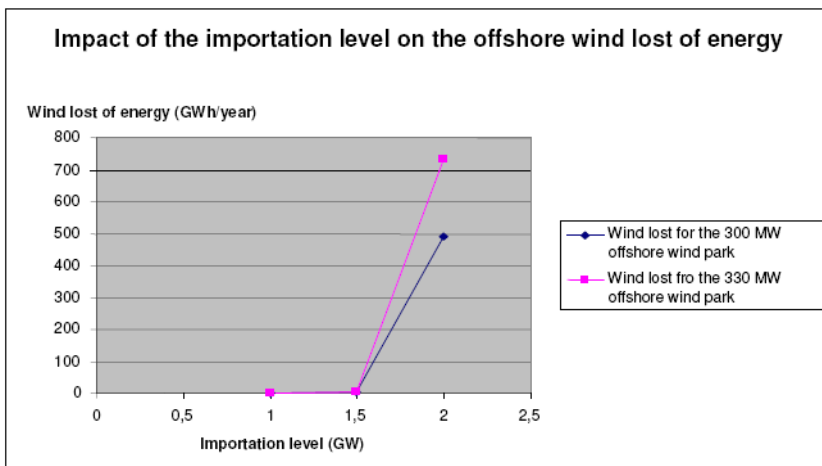

Fig. 13. Impact of the importation level on the offshore lost of energy (installed capacity set to 630 MW)

exchange between France and the Netherlands, not only a reduction of the transmitted wind power can be computed (Fig. 13) but it can also be observed that the number of congestion hours dramatically increases over the Rodenhuize-Heimolen line (Fig. 14). Therefore, in the context of large scale interconnected European networks, it will obviously be necessary to imagine new reinforcements over the Belgian transmission system (connection of Zeebrugge node to the 380 kV network or reinforcement of the Heimolen-Rodenhuize line).

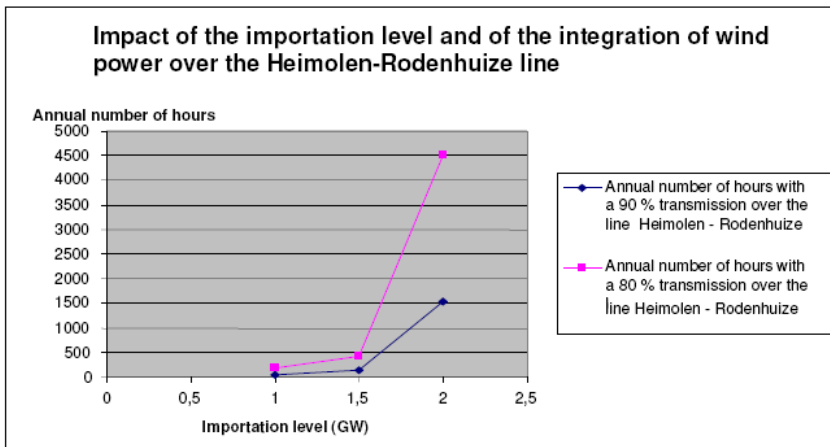

Fig. 14. Impact of the importation level and of the offshore wind power (installed capacity set to 630 MW) over the Heimolen-Rodenhuize line

Finally, it can thus be concluded that the proposed simulation tool permits to study reinforcement scenarii taking into account large scale integration of wind power. In that way, the developed program is thus perfectly suitable for the recent and future developments to be made over modern transmission systems.

6. Conclusion

In this chapter, wind generation has been introduced into a transmission system analysis tool. This last one was composed of two parts: system states generation (non sequential Monte Carlo simulation) and analysis (economic dispatch, DC load flow and eventual load shedding). In order to take into account wind generation in this simulation tool, each part had thus to be modified. Finally, a useful bulk power system analysis software taking into account wind generation has been developed and has permitted to study the impact of wind generation not only on reliability indices but also on the management of the classical production park. In that way, situations of forced wind stopping were pointed out due to increased wind penetration and transmission system operation constraints. Moreover, the interest of the proposed software was demonstrated by adequately determining reinforcements to be made in order to optimize large scale wind penetration in modern real case electrical systems.

7. References

- Al Aimani S. (2004). Modélisation de différentes technologies d'éoliennes intégrées à un réseau de distribution moyenne tension, *Ph.D. Thesis*, Ecole Centrale de Lille, chap.2, pp.24-25, Dec. 2004.
- Allan R.N., Billinton R. (2000). Probabilistic assessment of power systems, *Proceedings of the IEEE*, Vol. 22, No.1, Feb. 2000.
- Billinton R., Kumar S., Chowdbury N., Chu K., Debnath K., Goel L., Kahn E., Kos P., Nourbakhsh, Oteng-Adjei J. (1989). A reliability test system for educational purposes – Basic data. *IEEE Trans. On Power Systems*, Vol. 4, No. 3, Aug. 1989, pp. 1238-1244.
- Billinton R., Chen H., Ghajar R. (1996). A sequential simulation technique for adequacy evaluation of generating systems including wind energy. *IEEE Trans. On Energy Conversion*, Vol. 11, No. 4, Dec. 1996, pp.728-734.
- Billinton R., Bai G. (2004). Generating capacity adequacy associated with wind energy. *IEEE Trans. On Energy Conversion*, Vol. 19, No. 3, Sept. 2004, pp. 641-646.
- Billinton R., Wangdee W. (2007). Reliability-based transmission reinforcement planning associated with large-scale wind farms. *IEEE Trans. On Power Systems*, Vol. 22, No. 1, Feb. 2007, pp. 34-41.
- Buyse H. (2004). Electrical energy production. *Electrabel documentaion*, available web site: www.lei.ucl.ac.be/~matagne/ELEC2753/SEM12/S12TRAN.PPT, 2004.
- Ernst B. (2005). Wind power forecast for the German and Danish networks. *Wind Power in Power Systems*, edited by Thomas Ackerman, John Wiley & Sons, chap.17, pp.365-381, 2005.
- Mackensen R., Lange B., Schlögl F. (2006). Integrating wind energy into public power supply systems – German state of the art. *International Journal of Distributed Energy Sources*, Vol. 3, No.4, Dec. 2007.
- Maupas F. (2006). Analyse des règles de gestion de la production éolienne : inter-comparaison de trois cas d'étude au Danemark, en Espagne et en Allemagne. Working paper, *GRJM Conference*, Feb. 2006.
- Papaefthymiou G. (2006). Integration of stochastic generation in power systems. *PhD. Thesis*, Delft University, chap. 5 & 6, June 2006.
- Papaefthymiou G., Schavemaker P.H., Van der Sluis L., Kling W.L., Kurowicka D., Cooke R.M. (2006). Integration of stochastic generation in power systems. *International Journal of Electrical Power & Energy Systems*, Vol. 18, N°9, Nov. 2006, pp. 655-667.
- Sacharowitz S. (2004). Managing large amounts of wind generated power feed in – Every day challenges for a German TSO and approaches for improvements. *International Association for Energy Economics (IAEE)*, 2004 North American Conference, Washington DC, USA, 2004.
- Vallee F., Lobry J., Deblecker O., (2008). System reliability assessment method for wind power integration. *IEEE Trans. On Power Systems*, Vol. 23, No. 3, Aug. 2008, pp. 1288-1297.
- Van Roy P., Soens J., Driesen Y., Belmans R. (2003), Impact of offshore wind generation on the Belgian high voltage grid, *European Wind Energy Conference (EWEC)*, Madrid, Spain, June 2003.

Wangdee W., Billinton R. (2006). Considering load-carrying capability and wind speed correlation of WECS in generation adequacy assessment. *IEEE Trans. On Energy Conversion*, Vol. 21, No. 3, Sept. 2006, pp. 734-741.



Wind Power

Edited by S M Muyeen

ISBN 978-953-7619-81-7

Hard cover, 558 pages

Publisher InTech

Published online 01, June, 2010

Published in print edition June, 2010

This book is the result of inspirations and contributions from many researchers of different fields. A wide verity of research results are merged together to make this book useful for students and researchers who will take contribution for further development of the existing technology. I hope you will enjoy the book, so that my effort to bringing it together for you will be successful. In my capacity, as the Editor of this book, I would like to thanks and appreciate the chapter authors, who ensured the quality of the material as well as submitting their best works. Most of the results presented in to the book have already been published on international journals and appreciated in many international conferences.

How to reference

In order to correctly reference this scholarly work, feel free to copy and paste the following:

Francois Vallee, Olivier Deblecker, Jacques Lobry (2010). Impact of Real Case Transmission Systems Constraints on Wind Power Operation, Wind Power, S M Muyeen (Ed.), ISBN: 978-953-7619-81-7, InTech, Available from: <http://www.intechopen.com/books/wind-power/impact-of-real-case-transmission-systems-constraints-on-wind-power-operation>

INTECH

open science | open minds

InTech Europe

University Campus STeP Ri
Slavka Krautzeka 83/A
51000 Rijeka, Croatia
Phone: +385 (51) 770 447
Fax: +385 (51) 686 166
www.intechopen.com

InTech China

Unit 405, Office Block, Hotel Equatorial Shanghai
No.65, Yan An Road (West), Shanghai, 200040, China
中国上海市延安西路65号上海国际贵都大饭店办公楼405单元
Phone: +86-21-62489820
Fax: +86-21-62489821

© 2010 The Author(s). Licensee IntechOpen. This chapter is distributed under the terms of the [Creative Commons Attribution-NonCommercial-ShareAlike-3.0 License](#), which permits use, distribution and reproduction for non-commercial purposes, provided the original is properly cited and derivative works building on this content are distributed under the same license.