

Nonparametric Modeling and Model-Based Control of the Insulin-Glucose System*

Mihalis G. Markakis¹, Georgios D. Mitsis², George P. Papavassilopoulos³
and Vasilis Z. Marmarelis⁴

¹ *Massachusetts Institute of Technology, Cambridge, MA, USA*

² *University of Cyprus, Nicosia, Cyprus*

³ *National Technical University of Athens, Athens, Greece*

⁴ *University of Southern California, Los Angeles, CA, USA*

1. Introduction

Diabetes represents a major threat to public health with alarmingly rising trends of incidence and severity in recent years, as it appears to correlate closely with emerging patterns of nutrition/diet and behavior/exercise worldwide. The concentration of blood glucose in healthy human subjects is about 90 mg/dl and defines the state of normoglycaemia. Significant and prolonged deviations from this level may give rise to numerous pathologies with serious and extensive clinical impact that is increasingly recognized by current medical practice. When blood glucose concentration falls under 60 mg/dl, we have the acute and very dangerous state of hypoglycaemia that may lead to brain damage or even death if prolonged. On the other hand, when blood glucose concentration rises above 120 mg/dl for prolonged periods of time, we are faced with the detrimental state of hyperglycaemia that may cause a host of long-term health problems (e.g. neuropathies, kidney failure, loss of vision etc.). The severity of the latter clinical effects is increasingly recognized as medical science advances and diabetes is revealed as a major lurking threat to public health with long-term repercussions.

Prolonged hyperglycaemia is usually caused by defects in insulin production, insulin action (sensitivity) or both (Carson et al., 1983). Although blood glucose concentration depends also on the action of several other hormones (e.g. epinephrine, norepinephrine, glucagon, cortisol), the exact quantitative nature of this dependence remains poorly understood and the effects of insulin are considered the most important. So traditionally, the scientific community has focused on the study of this causal relationship (with infused insulin being the “input” and blood glucose being the “output” of a system representing this functional relationship), using mathematical modeling as the means of quantifying it. Needless to say, the employed mathematical model plays a critical role in achieving (or not) the goal of

* This work was supported by the Myronis Foundation (Graduate Research Scholarship), the European Social Fund (75%) and National Resources (25%) - Operational Program Competitiveness - General Secretariat for Research and Development (Program ENTER 04), a grant from the Empeirikion Foundation of Greece and the NIH Center Grant No P41-EB001978 to the Biomedical Simulations Resource at the University of Southern California.

effective glucose control. In addition, blood glucose concentration depends on many factors other than hormones, such as nutrition/diet, metabolism, endocrine cycles, exercise, stress, mental activity etc. The complexity of these effects cannot be modeled explicitly in a practical context at the present time and, thus, the aggregate effect of all these factors is usually represented for modeling purposes as a stochastic "disturbance" that is additive to the blood glucose level (or its rate of change).

Numerous studies have been conducted over the last 40 years to examine the feasibility of continuous blood glucose concentration control with insulin infusions. Since the achievement of effective glucose control depends on the quantitative understanding of the relationship between infused insulin and blood glucose, much effort has been devoted to the development of reliable mathematical and computational models (Bergman et al., 1981; Cobelli et al., 1982; Sorensen, 1985; Tresp et al., 1999; Hovorka et al., 2002; Van Herpe et al., 2006; Markakis et al., 2008a; Mitsis et al., in press). Starting with the visionary works of Kadish (Kadish, 1964), Pfeiffer et al. on the "artificial beta cell" (Pfeiffer et al., 1974), Albisser et al. on the "artificial pancreas" (Albisser et al., 1974) and Clemens et al. on the "biostator" (Clemens et al., 1977), the efforts for on-line glucose regulation through insulin infusions have ranged from the use of relatively simple linear control methods (Salzsieder et al., 1985; Fischer et al., 1990; Chee et al., 2003a; Hernjak & Doyle, 2005) to more sophisticated approaches including optimal control (Swan, 1982; Fisher & Teo, 1989; Ollerton, 1989), adaptive control (Fischer et al., 1987; Candas & Radziuk, 1994), robust control (Kienitz & Yoneyama, 1993; Parker et al., 2000), switching control (Chee et al., 2005; Markakis et al., in press) and artificial neural networks (Prank et al., 1998; Trajanoski & Wach, 1998). However, the majority of recent publications have concentrated on applying model-based control strategies (Parker et al., 1999; Lynch & Bequette, 2002; Rubb & Parker, 2003; Hovorka et al., 2004; Hernjak & Doyle, 2005; Dua et al., 2006; Van Herpe et al., 2007; Markakis et al., 2008b) for reasons that are elaborated below.

These studies have had the common objective of regulating blood glucose levels in diabetics with appropriate insulin infusions, with the ultimate goal of an automated closed-loop glucose regulation (the holy grail of "artificial pancreas"). Due to the inevitable difficulties introduced by the complexity of the problem and the limitations of proper instrumentation or methodology, the original grand goal has often been substituted by the more modest goal of "diabetes management" (Harvey et al., 1986; Berger et al., 1990; Deutsch et al., 1990; Salzsieder et al., 1990) and the use of man-in-the-loop control strategies with partial subject participation, such as meal announcement (Goriya et al., 1988; Fisher, 1991; Brunetti et al., 1993; Hejlesen et al., 1997; Shimoda et al., 1997; Chee et al., 2003b).

In spite of the immense effort and the considerable resources that have been dedicated to this task, the results so far have been modest, with many studies contributing to our better understanding of this problem but failing to produce an effective solution with potential clinical utility and applicability. Technological limitations have always been a major issue, but recent advancements in the technology of long-term glucose sensors and insulin micro-pumps (Laser & Santiago, 2004; Klonoff, 2005) removed some of these past roadblocks and presented us with new opportunities in terms of measuring, analyzing and controlling blood glucose concentration with on-line insulin infusions.

It is our view that the lack of a widely accepted model of the insulin-glucose system (that is accurate under realistic operating conditions) represents at this time the main obstacle in achieving the stated goal. We note that almost all efforts to date for modeling the insulin-

glucose system (and consequently, for developing control strategies based on these models) have followed the “parametric” or “compartmental” route, which postulates a specific model structure (in the form of a set of differential/difference and algebraic equations) based on specific hypotheses regarding the underlying physiological mechanisms, in accordance with existing knowledge and current scientific understanding. The unknown parameters of the postulated model are subsequently estimated from the data, usually through least-squares or Bayesian fitting (Sorenson, 1980). Although this approach retains physiological relevance and interpretability of the obtained model, it presents the major limitation of being constrained *a priori* and, therefore, being subject to possible biases that may narrow the range of its applicability. This constraint becomes even more critical in light of the intrinsic complexity of physiological systems which includes the presence of nonlinearities, nonstationarities and patient-specific dynamics.

We propose that this modeling challenge be addressed by the so-called “nonparametric” approach, which employs models of the general form of Volterra functional expansions and their many variants (Marmarelis, 2004). The main advantage of this generic model form is that it remains valid for a very broad class of systems and covers most physiological systems under realistic operating conditions. The unknown quantities in these nonparametric models are the “Volterra kernels” (or their equivalent representations that are discussed below), which are estimated by use of the available data. Thus, there is no need for *a priori* postulation of a specific model and no problems with potential modeling biases. The estimated nonparametric models are “true to the data” and capable of predicting the system output for all possible inputs. The latter attribute of “universal predictor” makes them suitable for the purpose of model-based control of complex physiological systems, for which accurate parametric models are not available under broad operating conditions.

This book chapter begins with a brief presentation of the nonparametric modeling approach and its comparative advantages to the traditional parametric modeling approaches, continues with the presentation of a nonparametric model of the insulin-glucose system and concludes with demonstrating the feasibility of incorporating such a model in a model-based control strategy for the regulation of blood glucose.

2. Nonparametric Modeling

The modeling of many physiological systems has been pursued in the context of the general Volterra-Wiener approach, which is also termed nonparametric modeling. This approach views the system as a “black box” that is defined by its specific inputs and outputs and does not require any prior assumptions about the model structure. As mentioned before, the nonparametric approach is generally applicable to all nonlinear dynamic systems with finite memory and contains unknown kernel functions that are estimated in practice by use of the available input-output data. Although the seminal Wiener formulation of this problem required the use of long data-records of white-noise inputs (Marmarelis & Marmarelis, 1978), this requirement has been removed and nonparametric modeling is now feasible with arbitrary input-output data of modest length (Marmarelis, 2004). In this formulation, the dynamic relationship between the input $i(n)$ and output $g(n)$ of a causal, nonlinear system of order Q and memory M is described in discrete-time by the following general/canonical expression of the output in terms of a hierarchical series of discrete multiple convolutions of the input:

$$g(n) = \sum_{q=0}^Q \sum_{m_1=0}^M \dots \sum_{m_q=0}^M k_q(m_1, \dots, m_q) i(n-m_1) \dots i(n-m_q) = \quad (1)$$

$$k_0 + \sum_{m=0}^M k_1(m) i(n-m) + \sum_{m_1=0}^M \sum_{m_2=0}^M k_2(m_1, m_2) i(n-m_1) i(n-m_2) + \dots$$

where the q^{th} convolution term corresponds to the effects of the q^{th} order nonlinearities of the causal input-output relationship and involves the Volterra kernel $k_q(m_1, \dots, m_q)$, which characterizes fully the q^{th} order nonlinear properties of the system. The linear component of the model/system corresponds to the first convolution term and the respective first order kernel $k_1(m)$ corresponds to the traditional impulse response function of a linear system. The general model of Eq. (1) can approximate any causal and stable system with finite memory to a desired accuracy for appropriate values of Q (Boyd & Chua, 1984). This approach has been employed extensively for modeling physiological systems because of their intrinsic complexity (Marmarelis, 2004).

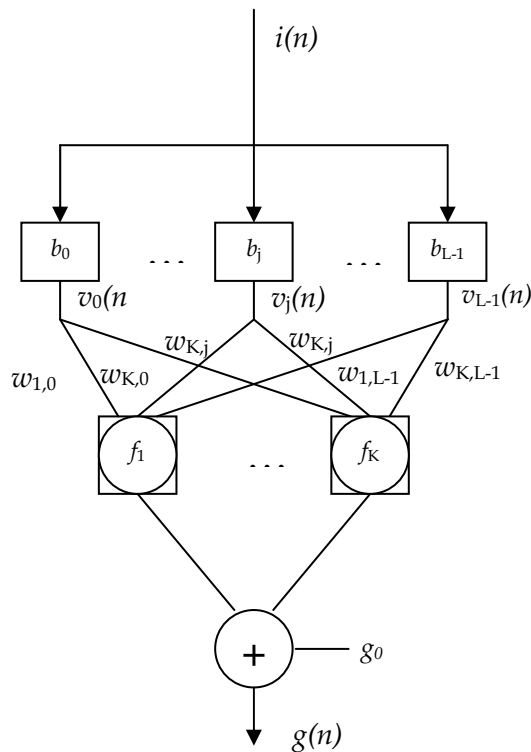

Fig. 1. The architecture of the Laguerre-Volterra network (LVN) that yields efficient approximations of nonparametric Volterra models in a robust manner using short data-records under realistic operating conditions (see text for description).

Among the various methods that have been developed for the estimation of the discrete Volterra kernels from input-output data, we select the method utilizing a Volterra-equivalent network in the form of a Laguerre-Volterra Network (LVN), which has been found to be efficient for the accurate representation of high-order systems in the presence of noise using short input-output records (Mitsis & Marmarelis, 2002). Therefore, it is well suited to the present application that typically relies on relatively short input-output records and is characterized by considerable measurement errors and systemic noise. The LVN model consists of an input layer of a Laguerre filter-bank and a hidden layer of K hidden units with polynomial activation functions (Figure 1). At each discrete time n , the input signal $i(n)$ is convolved with the Laguerre filters and the filter-bank outputs are subsequently transformed by the hidden units, the outputs of which form additively the model output. The unknown parameters of the LVN are the in-bound weights and the coefficients of the polynomial activation functions of the hidden units, along with the Laguerre parameter of the filter-bank and the output offset. These parameters are estimated from input-output data through an iterative procedure based on gradient descent. The filter-bank outputs v_j are the convolutions of the input $i(n)$ with the impulse response of the j^{th} order discrete-time Laguerre function, b_j :

$$b_j(m) = \alpha^{(m-j)/2} (1-\alpha)^{j/2} \sum_{i=0}^j (-1)^i \binom{m}{i} \binom{j}{i} \alpha^{j-i} (1-\alpha)^i, \tag{2}$$

where the Laguerre parameter a in Eq. (2) lies between 0 and 1 and determines the rate of exponential decay of the Laguerre functions. As indicated in Figure 1, the weighted sums u_k of the filter-bank outputs v_j are subsequently transformed into z_k by the hidden units through polynomial transformations:

$$u_k(n) = \sum_{j=0}^{L-1} w_{k,j} v_j(n), \tag{3}$$

$$z_k(n) = \sum_{q=1}^Q c_{q,k} u_k^q(n). \tag{4}$$

The model output $g(n)$ is formed as the summation of the hidden-unit outputs z_k and a constant offset value g_0 :

$$g(n) = \sum_{k=1}^K z_k(n) + g_0 = \sum_{k=1}^K \sum_{q=1}^Q c_{q,k} u_k^q(n) + g_0, \tag{5}$$

where L is the number of functions in the filter-bank, K is the number of hidden units, Q is the nonlinear order of the model and $w_{k,j}$ and $c_{q,k}$ are the in-bound weights and the polynomial coefficients of the hidden units respectively. The input and output time-series data are used to estimate the LVN model parameters ($w_{k,j}$, $c_{q,k}$, the offset g_0 and the Laguerre parameter a) with an iterative gradient-descent algorithm as (Mitsis & Marmarelis, 2002):

$$\delta^{(r+1)} = \delta^{(r)} + \gamma_\beta \varepsilon^{(r)}(n) \sum_{k=1}^K f_k^{(r)}(u_k^{(r)}(n)) \sum_{j=0}^L w_{k,j} [v_j(n-1) + v_{j-1}(n)], \tag{6}$$

$$w_{k,j}^{(r+1)} = w_{k,j}^{(r)} + \gamma_w \varepsilon^{(r)}(n) f_k^{(r)}(u_k^{(r)}(n)) v_j(n), \tag{7}$$

$$c_{m,k}^{(r+1)} = c_{m,k}^{(r)} + \gamma_c \varepsilon^{(r)}(n) (u_k^{(r)}(n))^m, \quad (8)$$

where δ is the square root of the Laguerre parameter a , γ_β , γ_w and γ_c are positive learning constants, f denotes the polynomial activation function of Eq. (4), r denotes the iteration index and $\varepsilon^{(r)}(n)$ and $f_k^{(r)}(u_k)$ are the output error and the derivative of the polynomial activation function of the k^{th} hidden unit evaluated at the r^{th} iteration, respectively. The equivalent Volterra kernels can be obtained in terms of the LVN parameters as:

$$k_n(m_1, \dots, m_n) = \sum_{k=1}^K c_{n,k} \sum_{j_1=0}^{L-1} \dots \sum_{j_n=0}^{L-1} w_{k,j_1} \dots w_{k,j_n} b_{j_1}(m_1) \dots b_{j_n}(m_n), \quad (9)$$

which indicates that the Volterra kernels are implicitly expanded in terms of the Laguerre basis and the LVN represents a parsimonious way of parameterizing the general nonparametric Volterra model (Marmarelis, 1993; Marmarelis, 1997; Mitsis & Marmarelis, 2002; Marmarelis, 2004).

The structural parameters of the LVN model (L, K, Q) are selected on the basis of the normalized mean-square error (NMSE) of the output prediction achieved by the model, defined as the sum of squares of the model residuals divided by the sum of squares of the de-meaned true output. The statistical significance of the NMSE reduction achieved for model structures of increased order/complexity is assessed by comparing the percentage NMSE reduction with the *alpha*-percentile value of a chi-square distribution with p degrees of freedom (p is the increase of the number of free parameters in the more complex model) at a significance level *alpha*, typically set at 0.05.

The LVN representation is just one of the many possible Volterra-equivalent networks (Marmarelis & Zhao, 1997) and is also equivalent to a variant of the general Wiener-Bose model, termed the Principal Dynamic Modes (PDM) model. The PDM model consists of a set of parallel branches, each one of which is the cascade of a linear dynamic filter (PDM) followed by a static, polynomial nonlinearity (Marmarelis, 1997). This leads to model representations that are more parsimonious and facilitate physiological interpretation, since the resulting number of PDMs has been found to be small (2 or 3) in actual applications so far. The PDM model is formulated next for a finite memory, stable, discrete-time SISO system with input i and output g . The input signal $i(n)$ is convolved with each of the PDMs p_k and the PDM outputs $u_k(n)$ are subsequently transformed by the respective polynomial nonlinearities f_k to produce the model-predicted blood glucose output as:

$$\begin{aligned} g(n) &= g_b + f_1[u_1(n)] + \dots + f_K[u_K(n)] = \\ &= g_b + f_1[p_1(n) * i(n)] + \dots + f_K[p_K(n) * i(n)] \end{aligned}, \quad (10)$$

where g_b is the basal value of g and the asterisk denotes convolution. Note the similarity between the expressions of Eq. (5) and Eq. (10), with the only difference being the basis of functions used for the implicit expansion of the Volterra kernels (i.e., the Laguerre basis versus the PDMs) that makes the PDM representation more parsimonious – if the PDMs of the system can be found.

3. A Nonparametric Model of the Insulin-to-Glucose Causal Relationship

In the current section, we present and briefly analyze a PDM model of the insulin-glucose system (Figure 2), which is a slightly modified version of a model that appeared in (Marmarelis, 2004). This PDM model has been obtained from analysis of infused insulin – blood glucose data from a Type 1 diabetic over an eight-hour period. In the subsequent computational study it will be treated as the putative model of the actual system, in order to examine the efficacy of the proposed model-predictive control strategy. It should be emphasized that this model is subject-specific and valid only for the specific type of fast-acting insulin analog that was used in this particular measurement. Different types of insulin analogs are expected to yield different models for different subjects (Howey et al., 1994). The PDM model employed in each case must be estimated with data obtained from the specific patient with the particular type of infused insulin. Furthermore, this model is expected to be generally time-varying and, thus, it must be adapted over time at intervals consistent with the insulin infusion schedule.

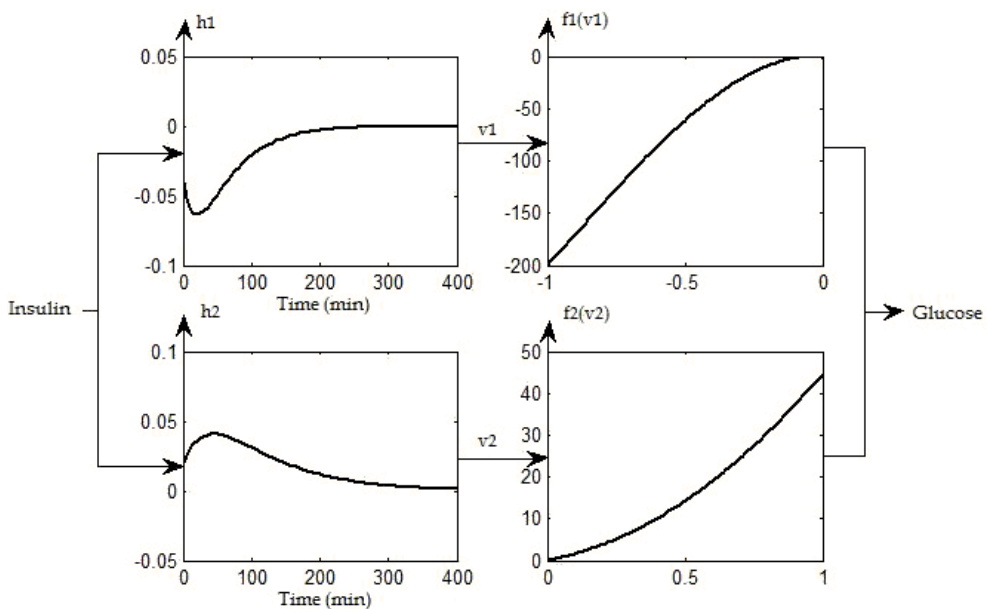

Fig. 2. The putative PDM model of the insulin–glucose system used in this computational study (see text for description of its individual components).

Firstly, we give a succinct mathematical description of the PDM model of Figure 2: the input $i(n)$, which represents the concentration of infused insulin at discrete time n (not the rate of infusion as in many computational studies), is transformed by the upper (h_1) and lower (h_2) branches through convolution to generate the PDM outputs $v_1(n)$ and $v_2(n)$. Subsequently, $v_1(n)$ and $v_2(n)$ are mapped by the cubic nonlinearities f_1 and f_2 respectively; their sum, $f_1(v_1)+f_2(v_2)$, represents the time-varying deviation of blood glucose concentration from its basal value g_0 . The blood glucose concentration at each discrete time n is given by:

$$g(n) = g_0 + f_1[h_1(n)*i(n)] + f_2[h_2(n)*i(n)] + D(n), \quad (11)$$

where $g_0 = 90$ mg/dl is a typical basal value of blood glucose concentration and $D(n)$ represents a “disturbance” term that incorporates all the other systemic and extraneous influences on blood glucose (described in detail later).

Remarkably, the two branches of the model of Figure 2 appear to correspond to the two main physiological mechanisms by which insulin affects blood glucose according to the literature, even though no prior knowledge of this was used during its derivation. The first mechanism (modeled by the upper PDM branch) is termed “*glucocleptis*” and reduces the blood glucose level due to higher glucose uptake by the cells (and storage of excess glucose in the liver and adipose tissues) facilitated by the insulin action. The second mechanism (modeled by the lower PDM branch) is termed “*glucogenesis*” and increases the blood glucose level through production or release of glucose by internal organs (e.g. converting glycogen stored in the liver), which is triggered by the elevated plasma insulin. It is evident from the corresponding PDMs in Figure 2 that glucogenesis is somewhat slower and can be viewed as a counter-balancing mechanism of “biological negative feedback” to the former mechanism of glucocleptis. Since the dynamics of the two mechanisms and the associated nonlinearities are different, they do not cancel each other but partake in an intricate act of dynamic counter-balancing that provides the desired physiological regulation. Note also that both nonlinearities shown in the PDM model of Figure 2 are supralinear (i.e. their respective outputs change more than linearly relative to a change in their inputs) and of significant curvature (i.e. second derivative); intuitively, this justifies why linear control methods, based on linearizations of the system, will not suffice and, thus, underlines the importance of considering a nonlinear control strategy in order to achieve satisfactory regulation of blood glucose.

The glucogenic branch corresponds to the combination of all factors that counter-act to hypoglycaemia and is triggered by the concentration of insulin: although their existence is an undisputed fact (Sorensen, 1985) to the best of our knowledge, none of the existing models in the literature exhibits a strong glucogenic component. This emphasizes the importance of being “true to the data” and the dangers from imposing a certain structure *a priori*. Another consequence is that including a significant glucogenic factor complicates the dynamics and much more care should be taken in the design of a controller.

Unlike the extensive use of parametric models for the insulin-glucose system, there are very few cases to date where the nonparametric approach has been followed e.g. the Volterra model in (Florian & Parker, 2002) which is, however, distinctly different from the nonparametric model of Figure 2. A PDM model of the functional relation between spontaneous variations of blood insulin and glucose in dog was presented by Marmarelis et al. (Marmarelis et al., 2002) and exhibits some similarities to the model presented above. Driven by the fact that the Minimal Model (Bergman et al., 1981) and its many variations over the last 25 years is by far the most widely used model of the insulin-glucose system, the equivalent nonparametric model was derived computationally and analytically (i.e. the Volterra kernels were expressed in terms of the parameters of the Minimal Model) and was shown to differ significantly from the model of Figure 2 (Mitsis & Marmarelis, 2007). To emphasize the important point that the class of systems representable by the Minimal Model and its many variations (including those with pancreatic insulin secretion) can be also represented accurately by an equivalent nonparametric model, although the opposite is

generally not true, we have performed an extensive computational study comparing the parametric and nonparametric approaches (Mitsis et al., in press).

4. Model - Based Control of Blood Glucose

In this section we formulate the problem of on-line blood glucose regulation and propose a model predictive control strategy, following closely the development in (Markakis et al., 2008b). A model-based controller of blood glucose in a nonparametric setting has also been proposed by Rubb & Parker (Rubb & Parker, 2003); however, both the model and the formulation of the problem are quite different than the ones presented here.

4.1 Closed - Loop System of Blood Glucose Regulation

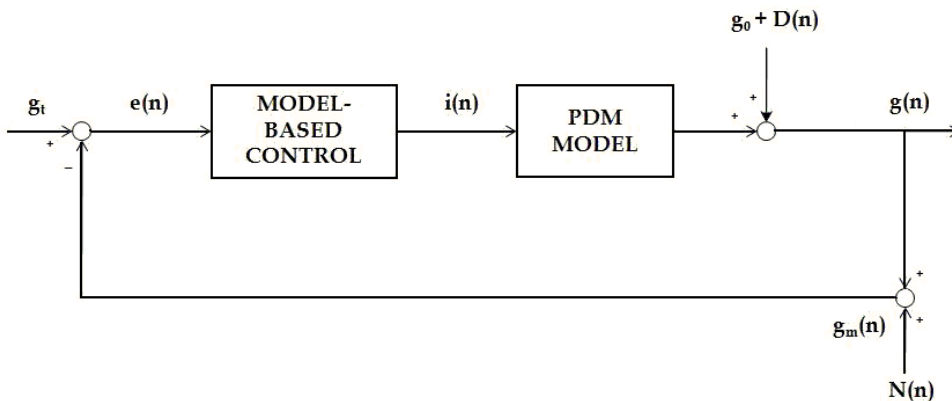

Fig. 3. Schematic of the closed-loop model-based control system for on-line regulation of blood glucose.

The block diagram of the proposed closed-loop control system for on-line regulation of blood glucose is shown in Figure 3. The PDM model presented in Section 3 plays the role of the real system in our simulations and defines the deviation of blood glucose from its basal value, in response to a given sequence of insulin infusions $i(n)$. The glucose basal value g_0 and the glucose disturbance $D(n)$ are superimposed on it to form the total value of blood glucose $g(n)$. Measurements of the latter are obtained in practice through commercially-available continuous glucose monitors (CGMs) that generate data-samples every 3 to 10 min (depending on the specific CGM). In the present work, the simulated CGM is assumed to make a glucose measurement every 5 min. Since the accuracy of these CGM measurements varies from 10% to 20% in mean absolute deviation by most accounts, we add to the simulated glucose data Gaussian "measurement noise" $N(n)$ of 15% (in mean absolute deviation) in order to emulate a realistic situation. Moreover, the short time lag between the concentration of blood glucose and interstitial fluids glucose is modeled as a pure delay of 5 minutes in the measurement of $g(n)$. A digital, model-based controller is used to compute the control input $i(n)$ to the system, based on the measured error signal $e(n)$ (the difference between the targeted value of blood glucose concentration g_t and the measured blood glucose $g_m(n)$). The objective of the controller is to attenuate the effects of the disturbance

signal and keep $g(n)$ within bounds defined by the normoglycaemic region. Usually the targeted value of blood glucose g_t is set equal (or close) to the basal value g_0 and a conservative definition of the normoglycaemic region is from 70 to 110 mg/dl.

4.2 Glucose Disturbance

It is desirable to model the glucose disturbance signal D in a way that is consistent with the accumulated qualitative knowledge in a realistic context and similar to actual observations in clinical trials - e.g. see the patterns of glucose fluctuations shown in (Chee et al., 2003b; Hovorka et al., 2004). Thus, we have defined the glucose disturbance signal through a combination of deterministic and stochastic components:

1. Terms of the exponential form $n^3 \cdot \exp(-0.19 \cdot n)$, which represent roughly the metabolic effects of Lehmann-Deutsch meals (Lehmann & Deutsch, 1992) on blood glucose of diabetics. The timing of each meal is fixed and its effect on glucose concentration has the form of a negative gamma-like curve, whose peak-time is at 80 minutes and peak amplitude is 100 mg/dl for breakfast, 350 mg/dl for lunch and 250 mg/dl for dinner;
2. Terms of the exponential form $n \cdot \exp(-0.15 \cdot n)$, which represent random effects due to factors such as exercise or strong emotions. The appearance of these terms is modeled with a Bernoulli arrival process with parameter $p=0.2$ and their effect on glucose concentration has again the form of a negative gamma-like function with peak-time of approximately 35 minutes and peak amplitude uniformly distributed in $[-10, 30]$ mg/dl;
3. Two sinusoidal terms of the form $a_i \cdot \sin(\omega_i \cdot n + \varphi_i)$ with specified amplitudes and frequencies (a_i and ω_i) and random phase φ_i , uniformly distributed within the range $[-\pi/2, \pi/2]$. These terms represent circadian rhythms (Lee et al., 1992; Van Cauter et al., 1992) with periods 8 and 24 hours and amplitudes around 10 mg/dl;
4. A constant term B which is uniformly distributed within the range $[50, 80]$ and represents a random bias of the subject-specific basal glucose from the nominal value of g_0 that many diabetics seem to exhibit.

An illustrative example of the combined effect of these disturbance factors on glucose fluctuations can be seen in Figure 4.

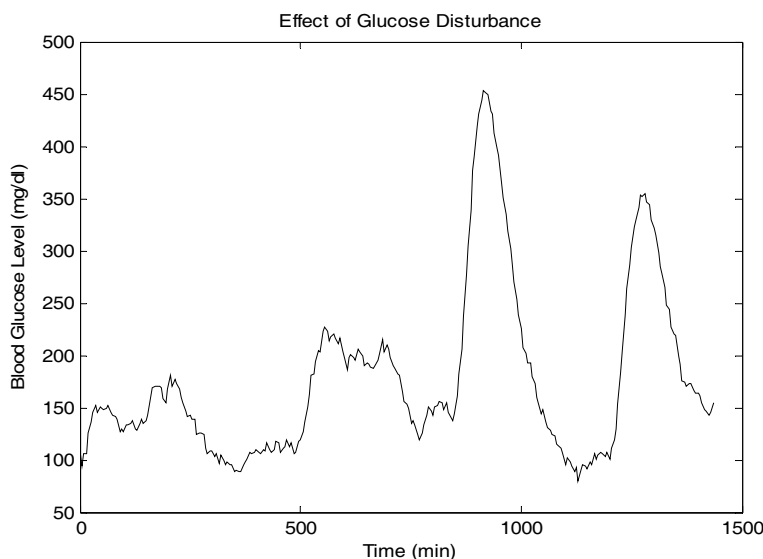

Fig. 4. Typical effect of glucose disturbance on the levels of blood glucose over a period of 24 hours.

The structure of the glucose disturbance signal described above is not known to the controller. However, in order to apply Model Predictive Control (MPC - the specific form of model-based control employed here) it would be desirable to predict the future values of the glucose disturbance term $D(n)$ within some error bounds, so that we can obtain reasonable predictions of the future values of blood glucose concentration over a finite horizon. To achieve this, we hypothesize that the glucose disturbance signal D can be considered as the output of an Auto-Regressive (AR) model:

$$D(n) = \mathbf{D} \cdot \mathbf{a} + w(n), \quad (12)$$

where $\mathbf{D} = [D(n-1) D(n-2) \dots D(n-K)]$, $\mathbf{a} = [a_1 a_2 \dots a_K]^T$ is the vector of coefficients of the AR model, $w(n)$ is an unknown "innovation process" (usually viewed as a white sequence), and K is the order of the AR model. At each discrete-time instant n , the prediction task consists of estimating the coefficient vector \mathbf{a} , which in turn allows the estimation of the future values of glucose disturbance: we use the estimated disturbance values as if they were actual values, in order to compute the glucose disturbance over the desired future horizon, using the AR model sequentially. The estimation of the coefficient vector can be performed with the least-squares method (Sorenson, 1980). Note, however, that we cannot know *a priori* whether the AR model is suitable for capturing the glucose disturbance presented above or if the least-squares criterion is appropriate in the AR context. What is most pertinent is the lack of correlation among the residuals. For this reason, we also compute the autocorrelation of the residuals and seek to make its values for all non-zero lags statistically insignificant, a fact indicating that all structured or correlated information in the glucose disturbance signal has been captured by the AR model. A critical part of this procedure is the determination of

the best AR model order K at every discrete-time instant. In the present study, we use for this task the Akaike Information Criterion (Akaike, 1974).

4.3 Model - Based Control of Blood Glucose

Here we outline the concept of Model Predictive Control (MPC), which is at the core of the proposed control algorithm. Having knowledge of the nonlinear model and of all the past input-output pairs, the goal of MPC is to determine the control input value $i(n)$ at every time instant n , so that the following cost function is minimized:

$$J(n) = [g(n+p|n) - g_t]^T \cdot \Gamma_y \cdot [g(n+p|n) - g_t] + \Gamma_U \cdot i(n)^2, \quad (13)$$

where $g(n+p|n)$ is the vector of predicted output values over a future horizon of p steps using the model and the past input values, Γ_y is a diagonal matrix of weighting coefficients assigning greater importance to the near-future predictions, and Γ_U a scalar that determines how “expensive” is the control input. We also impose a “physiological” constraint to the above optimization problem in order to avoid large deviations of plasma insulin from its basal value and, consequently, the risk of hypoglycaemia: we limit the magnitude of $i(n)$ to a maximum of 1.5 mU/L. The procedure is repeated at the next time step to compute $i(n+1)$ and so on. More details on MPC and relevant control issues can be found in (Camacho & Bordons, 2007; Bertsekas, 2005).

In our simulations, we considered a prediction horizon of 40 min ($p = 8$ samples) and exponential weighting Γ_y with a time constant of 50 min. As measures of precaution against hypoglycaemia, we used a target value for blood glucose that is greater than the reference value ($g_t = 105$ mg/dl) and also applied asymmetric weighting to the predicted output vector, as in (Hernjak & Doyle, 2005), whereby we penalized 10 times more the deviations of the vector $g(n+p|n)$ that are below g_t . The scalar Γ_U was set to 0 throughout our simulations.

4.4 Results

Throughout this section we assume that MPC has perfect knowledge of the nonlinear PDM model. Figure 5 presents MPC in action: the top panel shows the blood glucose levels without any control, apart from the basal insulin infusion (blue line), called also the “No-Control” case, and after MPC action (green line). The mean value (MV), standard deviation (SD) and the percentage of time that glucose is found outside the normoglycaemic region of 70-110 mg/dl (PTO) are reported between the panels for MPC and “No-Control”. The bottom panel shows the infused insulin profile determined by the MPC. Figure 6 presents the autocorrelation function of the estimated innovation process w . The fact that its values for all non-zero time-lags are statistically insignificant (smaller than the confidence bounds determined by the null hypothesis that the residuals are uncorrelated with zero mean) implies that the structure of the glucose disturbance signal is captured by the AR-Model. This result is important, considering that we have included a significant amount of stochasticity in the disturbance signal. In Figure 7 we show how the order of the AR model varies with time, as determined by the AIC, for the simulation case of Figure 5.

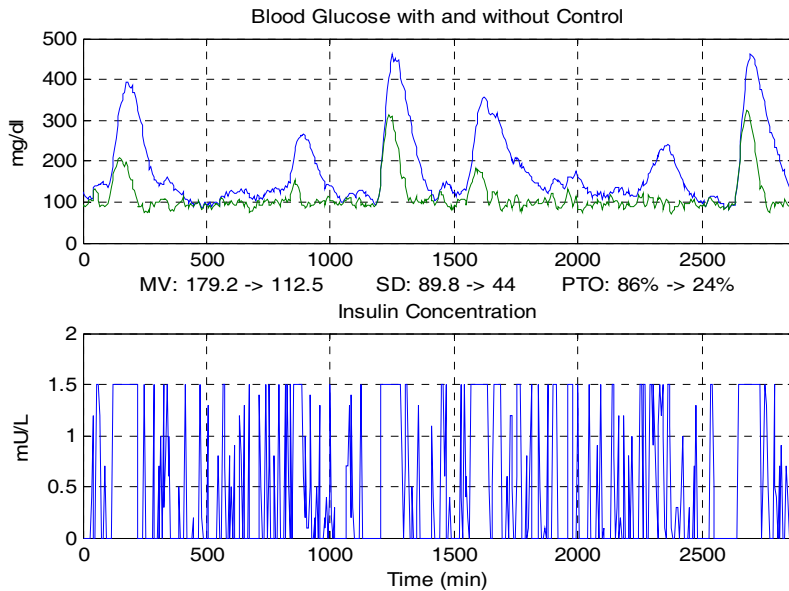

Fig. 5. Model Predictive Control of blood glucose concentration: The top panel shows the blood glucose levels corresponding to the general stochastic disturbance signal, with basal insulin infusion only (blue line) and after MPC action (green line). The mean value (MV), standard deviation (SD) and percentage of time that the glucose is found outside the normoglycaemic region of 70-110 mg/dl (PTO) are reported between the panels for MPC and without control action. The bottom panel shows the insulin profile determined by the MPC.

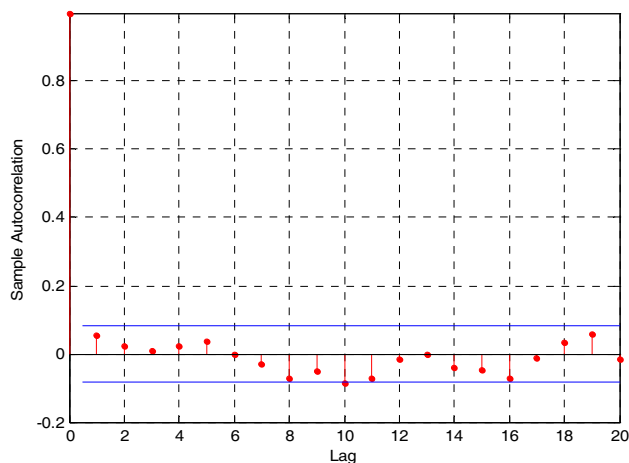

Fig. 6. Estimate of the autocorrelation function of the AR model residuals for the simulation run of Figure 5.

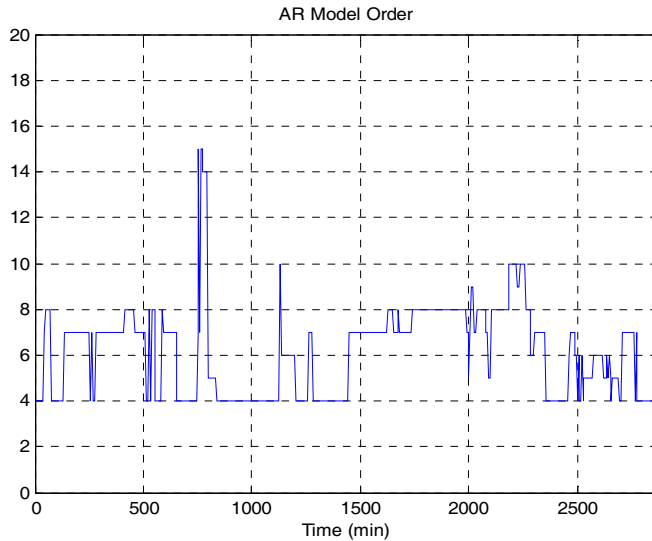

Fig. 7. The time-variations of the AR model order (as determined by AIC) for the simulation run of Figure 5.

Figure 8 provides further insight into how the attenuation of glucose disturbance is achieved by MPC: the controller determines the precise amount of insulin to be infused, given the various constraints, so that the time-varying sum of the outputs of glucoleptin (blue line) and glucogenesis (green line) cancel the stochastic disturbance (red line) in order to maintain normoglycaemia. A comment, however, must be made on the large values of the various signals of Figure 8: the PDM model presented in Section 3 aims primarily to capture the input-to-output dynamics of the system under consideration and not its internal structure (like parametric models do). So, even though the PDMs of Figure 2 seem intuitive and can be interpreted physiologically, we cannot expect that every signal will make physiological sense.

Finally, in order to average out the effects of stochasticity in glucose disturbance upon the results of closed-loop regulation of blood glucose, we report in Table 1 the average performance achieved by MPC over 20 independent simulation runs of 48 hours each. The evaluation of performance is done by comparing the standard indices (mean value, standard deviation, percent of time outside the normoglycaemic region) for the MPC and the “No-Control” case. The total number of hypoglycaemic events is also reported in the last row, since it is critical for patient safety. The results presented in this Table and in the Figures above indicate that MPC can regulate blood glucose quite well (as attested by the significant improvement in all measured indices) and, at the same time, does not endanger the patient.

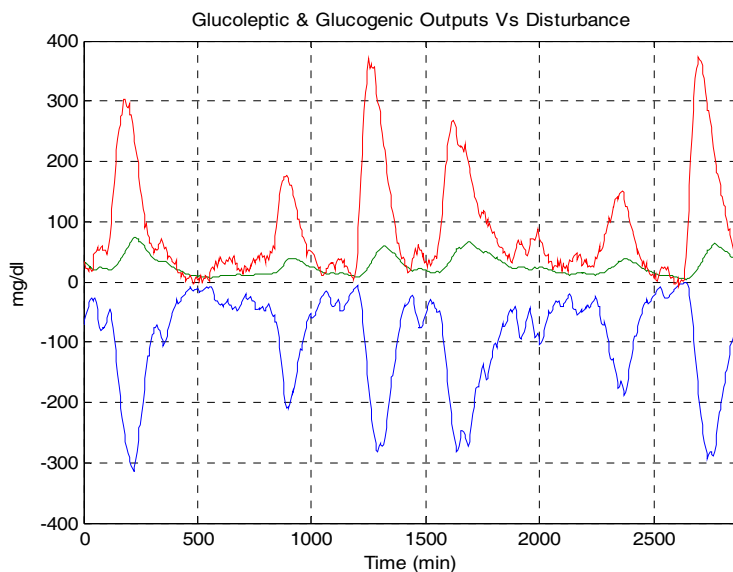

Fig. 8. MPC preserves normoglycaemia by cancelling out the effects of glucose disturbance (red line), the glucoleptic branch (blue line) and the glucogenic (green line) branch.

	NO CONTROL	MPC
MV	182.6	111.5
SD	89	42
PTO	87	25
HYPO	0	0

Table 1. Averages of 20 independent simulation runs of 48 hours each. Presented are the mean value (MV) and the standard deviation (SD) of glucose fluctuations, the percentage of time that glucose is found outside the normoglycaemic region 70-110 mg/dl (PTO) and the number of hypoglycaemic events, for the cases of no control action and MPC.

5. Discussion

This chapter is dedicated to the potential application of nonparametric modeling for model-based control of blood glucose through automated insulin infusions and seeks to:

1. Briefly outline the nonparametric modeling methodology and present a data-based nonparametric model, in the form of Principal Dynamic Modes (PDM), of the dynamics between infused insulin and blood glucose concentration. This model form provides an accurate, parsimonious and interpretable representation of this causal relationship for a specific patient and was obtained using a relatively short data-record. The estimation of nonparametric models (like the one presented here) is robust in the presence of noise and/or measurement errors and not liable to

- model misspecification errors that are possible (or even likely) in the case of hypothesis-based parametric or compartmental models. More information on the performance of nonparametric models in the context of the insulin-glucose system can be found in (Mitsis et al., in press);
2. Show the efficacy of utilizing PDM models in Model Predictive Control (MPC) strategies for on-line regulation of blood glucose. The results of our computational study suggest that a closed-loop, PDM - MPC strategy can regulate blood glucose well in the presence of stochastic and cyclical glucose disturbances, even when the data are corrupted by measurement errors and systemic noise, without risking dangerous hypoglycaemic events;
 3. Suggest an effective way for predicting stochastic glucose disturbances through an Auto-Regressive (AR) model, whose order is determined adaptively by use of the Akaike Information Criterion (AIC) or other equivalent statistical criteria. It is shown that this AR model is able to capture the basic structure of the glucose disturbance signal, even when it is corrupted by noise. This simple approach offers an attractive alternative to more complicated techniques that have been previously proposed -- e.g. utilizing a Kalman filter (Lynch & Bequette, 2002).

A comment is warranted regarding the procedure of insulin infusions, either intravenously or subcutaneously. Various studies have shown that in the case of fast acting, intravenously infused insulin the time-lag between the time of infusion and the onset of its effect on blood glucose is not significant, e.g. see (Hovorka, 2005) and references within. However, in the case of subcutaneously infused insulin, the considerably longer time-lag may compromise the efficacy of closed-loop regulation of blood glucose. Although this issue remains an open problem, the contribution of this study is that it demonstrates that the dynamic effects of infused insulin on blood glucose concentration may be "controllable" under the stipulated conditions, which seem realistic. Nonetheless, additional methodological improvements are possible, if the circumstances require them, which also depend on future technical advancements in glucose sensing and micro-pump technology, as well as the synthesis of even faster-acting insulin analogs.

There are numerous directions for future research, including improved methods for prediction of the glucose disturbance and the adaptability of the PDM model to the time-varying characteristics of the insulin-to-glucose relationship. From the control point of view, a critical issue remains the possibility of plant-model mismatch and its effect on the proposed MPC strategy (since the presented MPC results rely on the assumption that the controller has knowledge of an accurate PDM model). Last but not least, it is obvious that the clinical validation of the proposed control strategy, based on nonparametric models, is the ultimate step in adopting this approach.

6. References

- Akaike, H. (1974). A new look at the statistical model identification. *IEEE Transactions on Automatic Control*, Vol. 19, pp. 716-723
- Albisser, A.; Leibel, B.; Ewart, T.; Davidovac, Z.; Botz, C. & Zingg, W. (1974). An artificial endocrine pancreas. *Diabetes*, Vol. 23, pp. 389-404
- Berger, M.; Gelfand, R. & Miller, P. (1990). Combining statistical, rule-based and physiologic model-based methods to assist in the management of diabetes mellitus. *Computers and Biomedical Research*, Vol. 23, pp. 346-357
- Bergman, R.; Phillips, L. & Cobelli, C. (1981). Physiologic evaluation of factors controlling glucose tolerance in man. *Journal of Clinical Investigation*, Vol. 68, pp. 1456-1467
- Bertsekas, D. (2005). *Dynamic Programming and Optimal Control*, Athena Scientific, Belmont, MA
- Boyd, S. & Chua, L. (1985). Fading memory and the problem of approximating nonlinear operators with Volterra series. *IEEE Transactions on Circuits and Systems*, Vol. 32, pp. 1150-1161
- Brunetti, P.; Cobelli, C.; Cruciani, P.; Fabietti, P.; Filippucci, F.; Santeusano, F. & Sarti, E. (1993). A simulation study on a self-tuning portable controller of blood glucose. *International Journal of Artificial Organs*, Vol. 16, pp. 51-57
- Camacho, E. & Bordons, C. (2007). *Model Predictive Control*, Springer, New York, NY
- Candas, B. & Radziuk, J. (1994). An adaptive plasma glucose controller based on a nonlinear insulin/glucose model. *IEEE Transactions on Biomedical Engineering*, Vol. 41, pp. 116-124
- Carson, E.; Cobelli, C. & Finkelstein, L. (1983). *The Mathematical Modeling of Metabolic and Endocrine Systems*, John Wiley & Sons, New Jersey, NJ
- Chee, F.; Fernando, T.; Savkin, A. & Van Heerden, V. (2003a). Expert PID control system for blood glucose control in critically ill patients. *IEEE Transactions on Information Technology in Biomedicine*, Vol. 7, pp. 419-425
- Chee, F.; Fernando, T. & Van Heerden, V. (2003b). Closed-loop glucose control in critically ill patients using continuous glucose monitoring system (CGMS) in real time. *IEEE Transactions on Information Technology in Biomedicine*, Vol. 7, pp. 43-53
- Chee, F.; Savkin, A.; Fernando, T. & Nahavandi, S. (2005). Optimal H_{∞} insulin injection control for blood glucose regulation in diabetic patients. *IEEE Transactions on Biomedical Engineering*, Vol. 52, pp. 1625-1631
- Clemens, A.; Chang, P. & Myers, R. (1977). The development of biostator, a glucose controlled insulin infusion system (GCIS). *Hormone and Metabolic Research*, Vol. 7, pp. 23-33
- Cobelli, C.; Federspil, G.; Pacini, G.; Salvan, A. & Scandellari, C. (1982). An integrated mathematical model of the dynamics of blood glucose and its hormonal control. *Mathematical Biosciences*, Vol 58, pp. 27-60
- Deutsch, T.; Carson, E.; Harvey, F.; Lehmann, E.; Sonksen, P.; Tamas, G.; Whitney, G. & Williams, C. (1990). Computer-assisted diabetic management: a complex approach. *Computer Methods and Programs in Biomedicine*, Vol. 32, pp. 195-214
- Dua, P.; Doyle, F. & Pistikopoulos, E. (2006). Model-based blood glucose control for type 1 diabetes via parametric programming. *IEEE Transactions on Biomedical Engineering*, Vol. 53, pp. 1478-1491

- Fischer, U.; Schenk, W.; Salzsieder, E.; Albrecht, G.; Abel, P. & Freyse, E. (1987). Does physiological blood glucose control require an adaptive strategy?, *IEEE Transactions on Biomedical Engineering*, Vol. 34, pp. 575-582
- Fischer, U.; Salzsieder, E.; Freyse, E. & Albrecht, G. (1990). Experimental validation of a glucose insulin control model to simulate patterns in glucose-turnover. *Computer Methods and Programs in Biomedicine*, Vol. 32, pp. 249-258
- Fisher, M. & Teo, K. (1989). Optimal insulin infusion resulting from a mathematical model of blood glucose dynamics. *IEEE Transactions on Biomedical Engineering*, Vol. 36, pp. 479-486
- Fisher, M. (1991). A semiclosed-loop algorithm for the control of blood glucose levels in diabetics. *IEEE Transactions on Biomedical Engineering*, Vol. 38, pp. 57-61
- Florian, J. & Parker, R. (2002). A nonlinear data-driven approach to type 1 diabetic patient modeling. *Proceedings of the 15th Triennial IFAC World Congress*, Barcelona, Spain
- Furler, S.; Kraegen, E.; Smallwood, R. & Chisolm, D. (1985). Blood glucose control by intermittent loop closure in the basal model: computer simulation studies with a diabetic model. *Diabetes Care*, Vol. 8, pp. 553-561
- Goriya, Y.; Ueda, N.; Nao, K.; Yamasaki, Y.; Kawamori, R.; Shichiri, M. & Kamada, T. (1988). Fail-safe systems for the wearable artificial endocrine pancreas. *International Journal of Artificial Organs*, Vol. 11, pp. 482-486
- Harvey, F. & Carson, E. (1986). Diabeta - an expert system for the management of diabetes, In: *Objective Medical Decision- Making: System Approach in Disease*, Ed. Tsiftsis, D., Springer, New York, NY
- Hejlesen, O.; Andreassen, S.; Hovorka, R. & Cavan, D. (1997). Dias-the diabetic advisory system: an outline of the system and the evaluation results obtained so far. *Computer methods and programs in biomedicine*, Vol. 54, pp. 49-58
- Hernjak, N. & Doyle, F. (2005). Glucose control design using nonlinearity assessment techniques. *American Institute of Chemical Engineers Journal*, Vol. 51, pp. 544-554
- Hovorka, R. (2005). Continuous glucose monitoring and closed-loop systems. *Diabetes*, Vol. 23, pp. 1-12
- Hovorka, R.; Shojaee-Moradie, F.; Carroll, P.; Chassin, L.; Gowrie, I.; Jackson, N.; Tudor, R.; Umpleby, A. & Jones, R. (2002). Partitioning glucose distribution / transport, disposal, and endogenous production during IVGTT. *American Journal of Physiology*, Vol. 282, pp. 992-1007
- Hovorka, R.; Canonico, V.; Chassin, L.; Haueter, U.; Massi-Benedetti, M.; Orsini-Federici, M.; Pieber, T.; Schaller, H.; Schaupp, L.; Vering, T. & Wilinska, M. (2004). Nonlinear model predictive control of glucose concentration in subjects with type 1 diabetes. *Physiological Measurements*, Vol. 25, pp. 905-920
- Howey, D.; Bowsher, R.; Brunelle, R. and Woodworth, J. (1994). [Lys(B28), Pro(B29)]-human insulin: A rapidly absorbed analogue of human insulin. *Diabetes*, Vol. 43, pp. 396-402
- Kadish, A. (1964). Automation control of blood sugar. A servomechanism for glucose monitoring and control. *American Journal of Medical Electronics*, Vol. 39, pp. 82-86
- Kienitz, K. & Yoneyama, T. (1993). A robust controller for insulin pumps based on H-infinity theory. *IEEE Transactions on Biomedical Engineering*, Vol. 40, pp. 1133-1137
- Klonoff, D. (2005). Continuous glucose monitoring: roadmap for 21st century diabetes therapy. *Diabetes Care*, Vol. 28, pp. 1231-1239

- Laser, D. & Santiago, J. (2004). A review of micropumps. *Journal of Micromechanics and Microengineering*, Vol. 14, pp. 35-64
- Lee, A.; Ader, M.; Bray, G. & Bergman, R. (1992). Diurnal variation in glucose tolerance. *Diabetes*, Vol. 41, pp. 750-759
- Lehmann, E. & Deutsch, T. (1992). A physiological model of glucose-insulin interaction in type 1 diabetes mellitus. *Journal of Biomedical Engineering*, Vol. 14, pp. 235-242
- Lynch, S. & Bequette, B. (2002). Model predictive control of blood glucose in type 1 diabetics using subcutaneous glucose measurements, *Proceedings of the American Control Conference*, pp. 4039-4043, Anchorage, AK
- Markakis, M.; Mitsis, G. & Marmarelis, V. (2008a). Computational study of an augmented minimal model for glycaemia control, *Proceedings of the 30th Annual International EMBS Conference*, pp. 5445-5448, Vancouver, BC
- Markakis, M.; Mitsis, G.; Papavassilopoulos, G. & Marmarelis, V. (2008b). Model predictive control of blood glucose in type 1 diabetics: the principal dynamic modes approach, *Proceedings of the 30th Annual International EMBS Conference*, pp. 5466-5469, Vancouver, BC
- Markakis, M.; Mitsis, G.; Papavassilopoulos, G.; Ioannou, P. & Marmarelis, V. (in press). A switching control strategy for the attenuation of blood glucose disturbances. *Optimal Control, Applications & Methods*
- Marmarelis, V. (1993). Identification of nonlinear biological systems using Laguerre expansions of kernels. *Annals of Biomedical Engineering*, Vol. 21, pp. 573-589
- Marmarelis, V. (1997). Modeling methodology for nonlinear physiological systems. *Annals of Biomedical Engineering*, Vol. 25, pp. 239-251
- Marmarelis, V. & Marmarelis, P. (1978). *Analysis of physiological systems: the white-noise approach*, Springer, New York, NY
- Marmarelis, V. & Zhao, X. (1997). Volterra models and three-layer perceptrons. *IEEE Transactions on Neural Networks*, Vol. 8, pp. 1421-1433
- Marmarelis, V.; Mitsis, G.; Huecking, K. & Bergman, R. (2002). Nonlinear modeling of the insulin-glucose dynamic relationship in dogs, *Proceedings of the 2nd Joint EMBS/BMES Conference*, pp. 224-225, Houston, TX
- Marmarelis, V. (2004). *Nonlinear Dynamic Modeling of Physiological Systems*. IEEE Press & John Wiley, New Jersey, NJ
- Mitsis, G. & Marmarelis, V. (2002). Modeling of nonlinear physiological systems with fast and slow dynamics. I. Methodology. *Annals of Biomedical Engineering*, Vol. 30, pp. 272-281
- Mitsis, G. & Marmarelis, V. (2007). Nonlinear modeling of glucose metabolism: comparison of parametric vs. nonparametric methods, *Proceedings of the 29th Annual International EMBS Conference*, pp. 5967-5970, Lyon, France
- Mitsis, G.; Markakis, M. & Marmarelis, V. (in press). Non-parametric versus parametric modeling of the dynamic effects of infused insulin on plasma glucose. *IEEE Transactions on Biomedical Engineering*
- Ollerton, R. (1989). Application of optimal control theory to diabetes mellitus. *International Journal of Control*, Vol. 50, pp. 2503-2522
- Parker, R.; Doyle, F. & Peppas, N. (1999). A model-based algorithm for blood glucose control in type 1 diabetic patients. *IEEE Transactions on Biomedical Engineering*, Vol. 46, pp. 148-157

- Parker, R.; Doyle, F.; Ward, J. & Peppas, N. (2000). Robust H_{∞} glucose control in diabetes using a physiological model. *American Institute of Chemical Engineers Journal*, Vol. 46, pp. 2537-2549
- Pfeiffer, E.; Thum, C. & Clemens, A. (1974). The artificial beta cell—a continuous control of blood sugar by external regulation of insulin infusion (glucose controlled insulin infusion system). *Hormone and Metabolic Research*, Vol. 6, pp. 339-342
- Prank, K.; Jürgens, C.; Von der Mühlen, A. & Brabant, G. (1998). Predictive neural networks for learning the time course of blood glucose levels from the complex interaction of counter regulatory hormones. *Neural Computation*, Vol. 10, pp. 941-953
- Rubb, J. & Parker, R. (2003). Glucose control in type 1 diabetic patients: a Volterra model-based approach, *Proceedings of the International Symposium on Advanced Control of Chemical Processes*, Hong Kong
- Salzsieder, E.; Albrecht, G.; Fischer, U. & Freyse, E. (1985). Kinetic modeling of the glucoregulatory system to improve insulin therapy. *IEEE Transactions on Biomedical Engineering*, Vol. 32, pp. 846-855
- Salzsieder, E.; Albrecht, G.; Fischer, U.; Rutscher, A. & Thierbach, U. (1990). Computer-aided systems in the management of type 1 diabetes: the application of a model-based strategy. *Computer Methods and Programs in Biomedicine*, Vol. 32, pp. 215-224
- Shimoda, S.; Nishida, K.; Sakakida, M.; Konno, Y.; Ichinose, K.; Uehara, M.; Nowak, T. & Shichiri, M. (1997). Closed-loop subcutaneous insulin infusion algorithm with a short-acting insulin analog for long-term clinical application of a wearable artificial endocrine pancreas. *Frontiers of Medical and Biological Engineering*, Vol. 8, pp. 197-211
- Sorensen, J. (1985). A physiological model of glucose metabolism in man and its use to design and assess insulin therapies for diabetes. *PhD Thesis*, Department of Chemical Engineering, MIT, Cambridge, MA
- Sorenson, H. (1980). *Parameter Estimation*, Marcel Dekker Inc., New York, NY
- Swan, G. (1982). An optimal control model of diabetes mellitus. *Bulletin of Mathematical Biology*, Vol. 44, pp. 793-808
- Trajanoski, Z. & Wach, P. (1998). Neural predictive controller for insulin delivery using the subcutaneous route. *IEEE Transactions on Biomedical Engineering*, Vol. 45, pp. 1122-1134
- Tresp, V.; Briegel, T. & Moody, J. (1999). Neural network models for the blood glucose metabolism of a diabetic. *IEEE Transactions on Neural Networks*, Vol. 10, pp. 1204-1213
- Van Cauter, E.; Shapiro, E.; Tillil, H. & Polonsky, K. (1992). Circadian modulation of glucose and insulin responses to meals—relationship to cortisol rhythm. *American Journal of Physiology*, Vol. 262, pp. 467-475
- Van Herpe, T.; Pluymers, B.; Espinoza, M.; Van den Berghe, G. & De Moor, B. (2006). A minimal model for glycemia control in critically ill patients, *Proceedings of the 28th IEEE EMBS Annual International Conference*, pp. 5432-5435, New York, NY
- Van Herpe, T.; Haverbeke, N.; Pluymers, B.; Van den Berghe, G. & De Moor, B. (2007). The application of model predictive control to normalize glycemia of critically ill patients, *Proceedings of the European Control Conference*, pp. 3116-3123, Kos, Greece



New Developments in Biomedical Engineering

Edited by Domenico Campolo

ISBN 978-953-7619-57-2

Hard cover, 714 pages

Publisher InTech

Published online 01, January, 2010

Published in print edition January, 2010

Biomedical Engineering is a highly interdisciplinary and well established discipline spanning across engineering, medicine and biology. A single definition of Biomedical Engineering is hardly unanimously accepted but it is often easier to identify what activities are included in it. This volume collects works on recent advances in Biomedical Engineering and provides a bird-view on a very broad field, ranging from purely theoretical frameworks to clinical applications and from diagnosis to treatment.

How to reference

In order to correctly reference this scholarly work, feel free to copy and paste the following:

Mihalis G. Markakis, Georgios D. Mitsis, George P. Papavassilopoulos and Vasilis Z. Marmarelis (2010). Nonparametric Modeling and Model-Based Control of the Insulin-Glucose System, *New Developments in Biomedical Engineering*, Domenico Campolo (Ed.), ISBN: 978-953-7619-57-2, InTech, Available from: <http://www.intechopen.com/books/new-developments-in-biomedical-engineering/nonparametric-modeling-and-model-based-control-of-the-insulin-glucose-system>

INTECH
open science | open minds

InTech Europe

University Campus STeP Ri
Slavka Krautzeka 83/A
51000 Rijeka, Croatia
Phone: +385 (51) 770 447
Fax: +385 (51) 686 166
www.intechopen.com

InTech China

Unit 405, Office Block, Hotel Equatorial Shanghai
No.65, Yan An Road (West), Shanghai, 200040, China
中国上海市延安西路65号上海国际贵都大饭店办公楼405单元
Phone: +86-21-62489820
Fax: +86-21-62489821

© 2010 The Author(s). Licensee IntechOpen. This chapter is distributed under the terms of the [Creative Commons Attribution-NonCommercial-ShareAlike-3.0 License](#), which permits use, distribution and reproduction for non-commercial purposes, provided the original is properly cited and derivative works building on this content are distributed under the same license.