

Tag4M, a Wi-Fi RFID Active Tag Optimized for Sensor Measurements

Silviu Folea¹ and Marius Ghercioiu²

¹*Technical University of Cluj-Napoca, Department of Automation,*

²*Tag4M,*

¹*Romania,*

²*USA*

1. Introduction

Tag4M is a Wi-Fi RFID active tag with the functionality of a multifunctional Input/Output measurement device. The tag offers a combination of Wi-Fi radio and measurement capabilities for sensors and actuators that generate output as voltage, current, or digital signal. Tag4M is very suitable for prototyping of wireless sensor measurements and also for teaching wireless measurement using the existing Wi-Fi infrastructure.

In many applications cables need to be removed from measurement setups and replaced with wireless devices that are connected to sensors and send data wirelessly to the network and to computers. Wireless measurement devices that replace cabling need to be small and cheap and reliable in order to be a valid replacement for cabling. Mobile type measurement applications like monitoring of rotating machinery or moving objects also benefit from wireless measurement devices. Inside the class of wireless measurement devices there are those running on batteries. These devices are built around low or very low power microcontrollers, have the capability of going to sleep for long periods of time, and implement some kind of radio and associated communication protocol that are designed to save battery power.

Wireless USB, ZigBee, Bluetooth and ultra low-power Wi-Fi are the most common radio platforms used in wireless measurement and communication. Basic performance benchmarks for comparison of these technologies, things like application domains, typical range, network connectivity, network topology and key attributes are available in the reference (Sidhu et al., 2007).

Wireless USB devices, like the wireless mouse for example, are mostly used as computer peripherals. Bluetooth devices are more power hungry therefore this wireless technology is used in PDAs and computers that can be (re)charged overnight. The strength of Bluetooth lies in its ability to allow interoperability and replacement of cables.

ZigBee and ultra low power Wi-Fi are the two wireless technologies best suited for sensor measurement. The one major difference between ZigBee and ultra-low power Wi-Fi is that ZigBee nodes use the ZigBee protocol and not any native Internet protocol like TCP/IP or UDP, and therefore ZigBee nodes need a dedicated Access Point that translates ZigBee into TCP/IP in order for the data to be sent over the network. ZigBee networks can support a larger number of devices and in most cases, longer range between devices than Bluetooth

Source: Radio Frequency Identification Fundamentals and Applications, Design Methods and Solutions, Book edited by: Cristina Turcu, ISBN 978-953-7619-72-5, pp. 324, February 2010, INTECH, Croatia, downloaded from SCIYO.COM

for example. ZigBee is cheaper and has lower power consumption but its transfer rate is quite small if larger amount of information has to be sent (Labioud et al., 2007).

By comparison, Wi-Fi wireless LAN adapters are much more powerful and capable of reaching data transmission rates approaching 54Mbps. Wi-Fi products also have strong security protocols (WEP/WPA), which make them a better network solution. If key attributes for Wi-Fi are wider bandwidth and flexibility, for ZigBee are cost and power.

Inside the wide spectrum of existing Wi-Fi solutions, Tag4M chose a Wi-Fi radio that is ultra low power. The ultra-low power radio makes the tag suitable for sensing applications where battery power management is critical. The batteries must deliver a current peak up to 0.5A, but the pulse duration is very short, of about 1-2ms, due to high transmission rate. The ultra-low power Wi-Fi radio was chosen because of its small form factor, and capability to “talk” native Internet language TCP/IP and UDP. Tag4M does not need a specialized Access Point to reach the network. An off-the-shelf Access Point that is configured to “see” Wi-Fi tags will be able to route data from tags to the network and further to data client computers.

Tag4M exposes I/O terminal blocks, very similar to a data acquisition device. The tag user can build wireless sensor solutions for a wide range of applications by attaching Sensor wires to tag terminal blocks. Optimized tags with a lower cost to build can be built for custom applications. Wi-Fi networked sensors send measurements to web pages which in effect become “Web Instruments”. Web Instruments of all kind will be built and posted on the Internet to allow users of sensors to bring measurements into computers.

2. Tag4M – hardware description

2.1 Tag hardware components

Tag4M is a Wi-Fi 802.11 b/g tag solution for sensor measurements. The board is built upon G2 Microsystems’ 2.4GHz G2M5477 Wi-Fi radio module.

The G2M5477 is an embedded system incorporating a sensor interface, a 32-bit CPU, memory, operating system, complete Wi-Fi networking solution, TCP/IP network stack, crypto accelerator, power management system and real time clock (G2 Microsystems, 2008 a). WEP and WPA with a 4Mbit/s throughput sustained TCP/IP are the tag security suites. The G2C547 chip is the second generation of ultra low-power Wi-Fi SoCs from G2 Microsystems. Technical solutions based on the first ultra-low power chip, G2C501, were presented in (Ghercioiu, 2007) and (Folea & Ghercioiu, 2008). G2M5477 is the smallest, lowest power 802.11b/g module available.

The module supports adhoc and enterprise networking modes. Additionally, the radio module contains a 14-bit Analog-to-Digital Converter (ADC) that is used for the analog sensor interfaces. The tag offers four digital lines for general purpose I/O. The tag provides direct connections to an onboard thermistor for temperature reading, and to its own battery for voltage reading. The tag can be powered from a CR123A 3.0V battery if inserted in the tag battery holder, or from an external 3.3V DC adapter power supply. The Tag4M module is programmed and controlled with web, C++ and LabVIEW interfaces. Once the Tag4M module is powered it will scan to find an access point, associate, authenticate, and connect over any Wi-Fi network. Tag dimensions are 4.7cm x 7.0cm (Tag4M, 2009). A placement diagram of the tag system is presented in Figure 1.

A general bloc diagram of the tag system is presented in Figure 2. The tag offers the following analog interface:

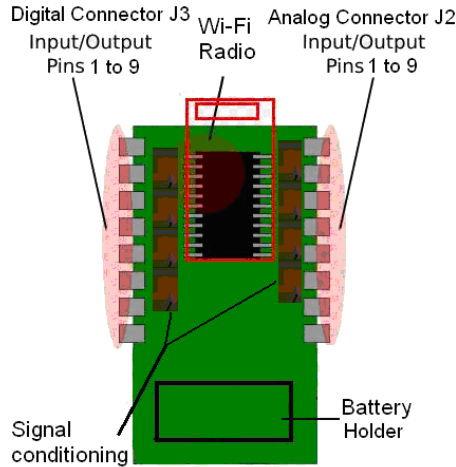

Fig. 1. Tag4M Placement Diagram

- one channel for 0-10V voltage input range,
- one channel for 4-20mA current input range,
- three channels for 0-400mV input range, channels with current generators capability between 0.2uA and 200uA to be connected to sensor extensions,
- one on-board temperature sensor implemented with a 10k 1% thermistor, and
- battery voltage measurement capability.

Conversion time for the onboard 14-bit analog-to-digital converter is between 35ms and 35us, with 1% gain error and 0.01% linear error accuracy.

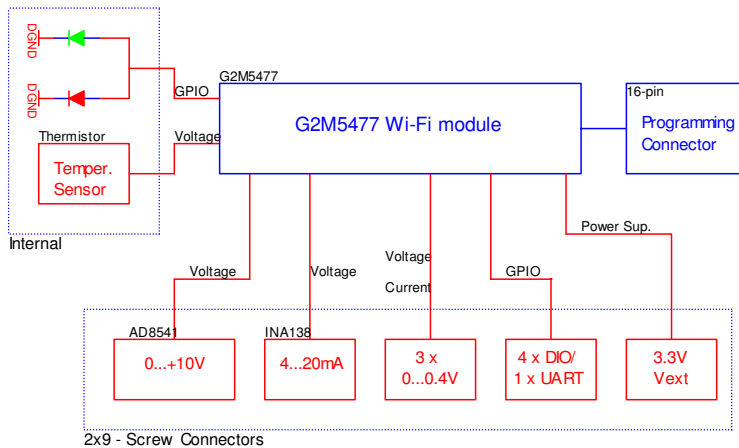

Fig. 2. Tag4M Bloc Diagram

Figure 3 displays a real size 1:1 scale picture of the Tag4M device. The tag has two I/O connectors marked J2 and J3 on the board. J3, the connector on left side is for digital signals and power supply while J2, the connector on right side is for the analog signal lines, 0-10V,

0-400mV, 4-20mA, and their reference Analog Ground (AGND). The battery holder is located on the lower part of the tag Printed Circuit Board (PCB).

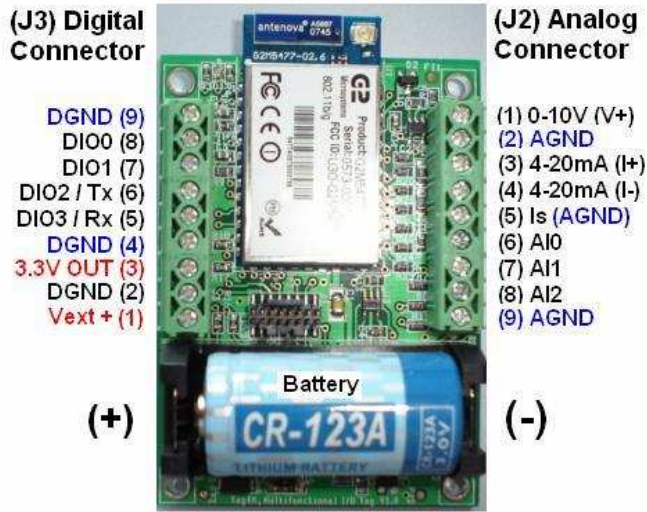

Fig. 3. Tag4M I/O Connector Blocks

Besides Wi-Fi radio, two I/O connector blocks, and conditioning circuitry, the tag implements protection circuitry against reversed battery mounting into tag battery holder, as shown in Figure 4.

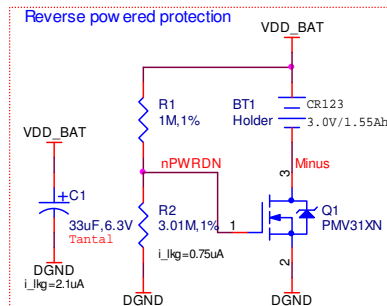

Fig. 4. Reverse Power Supply Protection

The reversed protection circuit is implemented using a MOSFET transistor in position Q1 and two resistors R1 and R2. Reversed protection is needed in case the battery is plugged-in reversed to protect the tag from malfunctioning. Capacitor C1’s role is to reduce the peak current from battery.

2.2 Sensor attachments

There will be a separate discussion regarding sensor attachments to the tag in Chapter 4. This section presents the measurement strategy in terms of channel selection when using the

tag. If the signal is in the range of 0-10V, it is recommended to wire it to the 0-10V (V+) and AGND I/O connector terminals. 0-10V measurement is done with a 14-bit precision ADC with accuracy in the +/- 5mV range. If the signal is in the range of 0-400mV, is recommended to wire it to one of the channels AI0, AI1, or AI2 referenced in AGND to increase the resolution at 14-bit. Channels AI0, 1, 2 have current drive capability which can be enabled in software and it should be used when reading thermistors or other sensors that need current excitation. Channel 4-20mA is assigned to current sensors. DIO lines 0, 1, 2, 3 are general input/output digital lines TTL compatible.

2.3 Power consumption

Tag power consumption is very much determined by the task the tag runs at any given moment in time. Generally speaking, the tag is running in power cycles, each cycle contains a period of sleep and a period of wake time. Inside a cycle, during the periods of sleep and wake, the tag executes distinct tasks in terms of amount of powered required and time to execute. Figure 5 bellow shows the current consumption and length of time for each of these tasks, during one cycle, when the tag is powered by a 3.0V, 1.55Ah Lithium battery. Total cycle length of time is between 150 and 500msec.

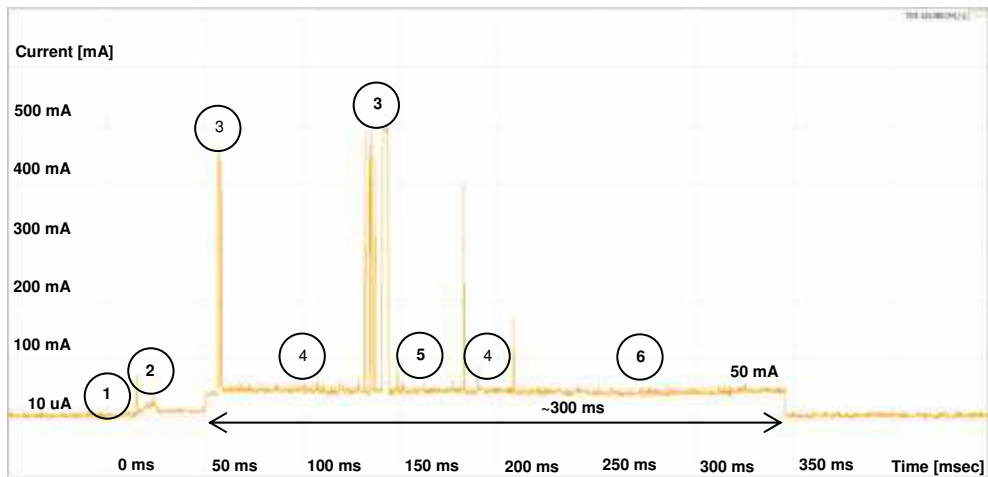

Fig. 5. Current consumption and Function Periods

The tag Wi-Fi radio module was designed for three distinct power domains in order to achieve flexible power management and lower power consumption. These power domains are (G2 Microsystems, 2008 c):

Sleep Mode: when the tag is in sleep mode the tag executes the minimum amount of tasks and by that consumes the minimum amount of power to stay alive.

In sleep mode power consumption is in the microwatts range, while the CPU and almost all tag components are not available. The following limited number of functions will run in this mode:

- decrement timers and detect expiry;
- detect the state change of switch sensors;
- monitor the sampled comparator and detect when external parameters pass preset thresholds;

- respond to battery brownout (low voltage) etc.

Doze Mode: when the tag is in doze mode the 1.3V rail will be powered and it will remain powered in order to facilitate the tag to respond very quickly to interrupt source (45ns). Tag CPU will not be clocked in doze mode.

Awake Mode: when the tag is in awake mode the 3.3V rail will be powered. The functions that will run when the tag is in the tag awake mode are:

- loading and executing programs from flash memory,
- communication based on Wi-Fi radio,
- measurements using the sensor interface,
- utilization of GPIO, SPI, SDIO and UART interfaces, reading and writing flash memory or NVM (Non Volatile Memory).

Transition from sleep to awake is triggered by an awake event, which is a subset of some specific interrupts.

The tag battery is capable of providing the peak power required for all tasks, including data transmission which is the most demanding in terms of power consumption. Obviously the battery cannot supply energy to make the tag operate in its high-power state indefinitely. If the execution of long tasks that are power hungry is required in an application, then the designer of this application needs to break long tasks into smaller tasks, and insert low-power states in between them. Let us look into the tasks that are executed during a full cycle. The tag is in sleep mode at the beginning of each cycle. Sleep is the very first task executed in each cycle (Ghercioiu et al., 2007)

Sleep period (Figure 5, #1). Sleep is the least power consuming state of a cycle. Sleep is also the longest tag state in terms of time (as in seconds, minutes, etc) occupied per cycle and also in terms of total tag life time. The tag consumes in average 4-10uA or about 100uW while it performs its sleep function. If a tag is not in sleep mode (and not in doze mode either as we do not activate this mode in firmware) then the tag is in awake mode. A tag wake-up event has five distinct periods as marked and seen in Figure 5.

Boot-up period (Figure 5, #2). The tag does two things during boot-up: it reads a pre-loaded application from flash and it starts execution. It takes an average of 20-30ms to execute these two tasks. Boot-up time may be reduced if using a fixed image that does not need to be searched for in tag flash. The tag will use 10-15mA of current during boot-up.

Transmit Data period (Figure 5, #3). The tag transmits data during transmit periods. You do want your transmit period to be the shortest period of time because it is the most power hungry of all periods in the life cycle. One transmit period can take anywhere between 1 to 10msec, and tag power consumption during this period may go up to 500mA while transmitting 802.11b frames.

CPU processing period (Figure 5, #4). The tag radio has a microcontroller which does all processing that is needed for processing of collected data and transmission via wireless. The CPU processing period is the period of time in the cycle occupied by the microcontroller doing the processing. This period can take anywhere from 100 to 150msec, depending on the amount and length of tasks that need to be processed by the microcontroller. The tag consumes 50mA in this state.

Measurement period (Figure 5, #5). This is the period of time occupied by the microcontroller for collecting data (or data acquisition). The measurement period is short, in the range of 12msec during which the Tag consumes on average 50mA. Measurement period precise timing and power consumption is presented in figure 6.

Receive Data period (Figure 5, #6). This is the period of time following a transmission when the tag is waiting for a command that may be coming from the Access Point. There may be no command, in fact most of the times there is none. The receive period was defined for cases when it is necessary to configure and reconfigure the tag for a different set of measurements during the same application. Tag configuration is done by sending commands to the tag immediately following a data transmission. Tag receive period may take between 0 and 500msec. The length of the receive period is software configurable.

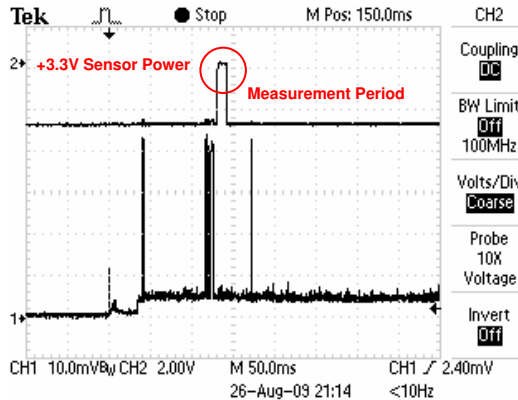

Fig. 6. Measurement Period

The average current consumption during an entire wake-up period is below 70mA. A Tag battery Life-Time Prediction Table was created based on the above power consumption period model and a CR123A lithium battery with a total charge capacity of 1550mAh:

Length of Sleep Period	Battery Life Time
1 s	52 hours
10 s	13 days
100 s	4 months
500 s	2 years

Table 1. Battery Life Time

The tag battery life time depends on two things: length of the sleep and wake-up times as shown in Table 1, but also on the functionality choices that are made in firmware, things like:

- If wireless security is turned ON/OFF,
- If the mechanism used to obtain network access is DHCP with fix IP address or a dynamic one,
- If the protocol used to deliver reports is UDP.

3. Tag description - software

The Tag4M software architecture contains two layers of software:

- Tag Firmware - is downloaded, it resides and runs from tag EEPROM and ROM memories,

- Tag Application Software - runs on a computer and interacts with the tag firmware with the purpose of controlling the tag application. Examples of application software packages used in tag applications are: Web page, LabVIEW, or a C++.

The tag application can run in two modes: Web Mode and Local Mode.

In **Web Mode**, tags send data to an Access Point (AP) that is located in the tag vicinity, and it is connected to the Internet. Data will be routed into the network by the AP and it will travel to the computer hosting the Web Instrument, wherever this is located. Other computers connected to the network can access the web page from their browser.

In **Local Mode**, tags send data to an Access Point (AP) that is located in the tag vicinity, and this Access Point may or may not be connected to the Internet. Data will be broadcasted by the AP to address 255.255.255.255 local wireless network and it will be captured at local PC Port 50007 by the computer that is hosting the local application software built tag instrument.

3.1 Tag firmware

The Tag4M firmware provides the infrastructure required by a tag application. Tag firmware contains an embedded operating system (eCos), a TCP/IP stack (LWIP), start-up code, an application loader, power saving features, and a device driver. This functionality resides in, and is run, from a ROM location on the tag, so it does not need to be loaded at start-up. The device driver contains definitions of tag opcodes (operation code), which are numerical codes that describe tag settings and tag measurement functions, and are loaded from an EEPROM location at start-up.

The tag firmware can perform the following functions:

- set sleep time,
- get sleep time,
- set receive period,
- get receive period,
- get total tag sleep period in msec,
- get total tag wake up period in msec,
- get tag battery voltage,
- get temperature value from on-board tag thermistor,
- get voltage reading from the 0-10V line with respect to AGND,
- get voltage reading from AI0, AI1, AI2 lines with respect to AGND,
- get current reading from 4-20mA I+, I- lines,
- get DIO0, 1, 2, 3 digital lines state,
- get tag RSSI value (Received Signal Strength Indication),
- get tag MAC address (Media Access Control),
- get tag IP address (Internet Protocol).

An opcode (operation code) is a pair of numbers that describes a certain function. The first number in the pair is the function code, while the second number is the value of that particular function. Let us look at opcode (1, 3000) as an example. The first parameter (1) is the code for tag sleep time, which in this example is set to 3000msec. The list of all supported opcodes in tag firmware is presented in Table 2.

To activate an input the application sends opcode 131, followed by a pair of numbers indicating the function to activate and current value. The set number is 12-bit format, with 1 for an active input is presented in Table 3.

(1, 3000)	Sleep time = 3000ms
(2, 120)	Tag receive period = 120ms
(3, 303)	Total power down period = 303msec
(4, 28)	Total power up period = 28msec
(13, xxx)	check value (last message acked)
(132, 25686)	Tag thermistor temperature value = 25.686 Deg. C (25686/1000)
(2180, 18809)	Current measured at Tag 4-20mA (I+) and (Is) is 0.188mA (18809/100000)
(2436, 300829)	Voltage measured at Tag 0-10V(V+) with respect to AGND channel is 3.008V (300829/100000)
(388, 28000)	Voltage measured at AI0(6) with respect to AGND(9) channel is 280.0mV
(644, 32000)	Voltage measured at AI1(7) with respect to AGND(9) channel is 320.0mV
(900, 2900)	Voltage measured at AI2(8) with respect to AGND(9) channel is 29.0mV
(1156, N)	State of Digital Line DIO0
(1412, N)	State of Digital Line DIO1
(1668, N)	State of Digital Line DIO2
(1924, N)	State of Digital Line DIO3
(2948, -39)	Tag RSSI value = -39dBm
(2692, 2844)	Tag Battery Voltage value = 2.844V (2844/1000)

Table 2. Opcodes in Tag Firmware

Temp.	A0	A1	A2	DIO0	DIO1	DIO2	DIO3	4-20mA	0-10V	Vbatt	RSSI
-------	----	----	----	------	------	------	------	--------	-------	-------	------

Table 3. The Function to Activate

3.2 Web instrument

A Web Instrument as shown in Figure 7 is a web page hosted by a computer which allows the user of tags to configure tags for measurement, read the data and display the information in a user friendly interface that is easy to use.

Web Instruments are true virtual instruments because the physical part of the instrument may be located very far away from the instrument panel. The web instrument leverages the network as infrastructure technology.

A Web Instrument is very configurable, each tag that is displayed can be individually configured. By clicking on the tag MAC address, the Web Instrument opens a configuration window that allows the tag to be configured for the set of measurements that need to be made and duration of sleep time. The tag can be calibrated by filling in the calibration coefficients under the Calibration tab. Finally, by clicking on the Settings tab the IP address of the host computer, which is the computer running the web page application can be changed. The configuration window is presented in figure 8.



Tag4m - DEMO Web Page
Number of active TAGs :5 Date: 9/24/2009 Time: 11:23:22 Page refresh interval: 1

MAC	TEMP	0-10V	4-20mA	AI 0	AI 1	AI 2	DIO 0	DIO 1	DIO 2	DIO 3	VBATT	RSSI	SLEEP
0012B8002001	26.0 C	3.015 V	0.086 mA	301.26 mV	301.28 mV	301.00 mV	0	0	0	0	2.94V	-77dBm	1s
0012B8000585	24.7 C	0.193 V	0.157 mA	259.25 mV	255.85 mV	254.56 mV	0	0	0	1	3.11V	-46dBm	0.1s
0012B8000547	23.3 C	0.144 V	-	254.23 mV	255.67 mV	254.86 mV	-	0	0	-	2.91V	-62dBm	10s
0012B800078F	23.3 C	0.215 V	-	256.07 mV	-	-	0	0	0	0	2.68V	-65dBm	10s
0012B8000798	23.3 C	-	0.000 mA	-	255.31 mV	253.39 mV	0	-	-	0	2.28V	-63dBm	10s
0012B80007FF	23.4 C	0.163 V	-	255.32 mV	257.29 mV	-	-	0	-	0	2.86V	-60dBm	10s

Fig. 7. Web Instrument Example

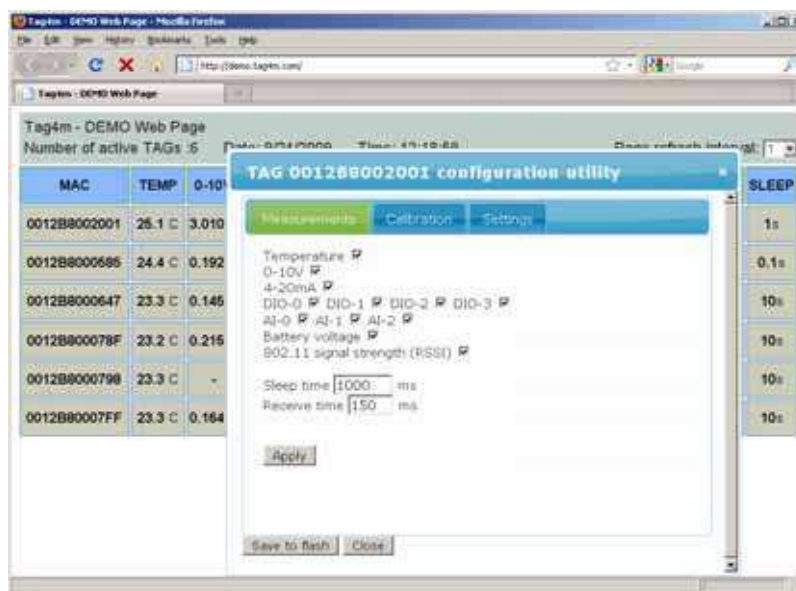

Tag4m - DEMO Web Page
Number of active TAGs :5 Date: 9/24/2009 Time: 11:23:22 Page refresh interval: 1

TAG 0012B8002001 configuration utility

Measurements Calibration Settings

Temperature
 0-10V
 4-20mA
 DIO-0 DIO-1 DIO-2 DIO-3
 AI-0 AI-1 AI-2
 Battery voltage
 B02.11 signal strength (RSSI)

Sleep time ms
 Receive time ms

Apply

Save to flash Close

MAC	TEMP	0-10V	SLEEP
0012B8002001	26.1 C	3.010	1s
0012B8000585	24.4 C	0.192	0.1s
0012B8000547	23.3 C	0.145	10s
0012B800078F	23.2 C	0.215	10s
0012B8000798	23.3 C	-	10s
0012B80007FF	23.3 C	0.164	10s

Fig. 8. Configuration Panel presented by the Web Instrument Example

3.3 LabVIEW driver

If a tag measurement application is running in Local Mode, chances are high that LabVIEW is used as PC application environment. Tag4M tags have a LabVIEW Driver which is a set of ready-made instruments that allow tag users to talk to their tags from inside LabVIEW running on a local PC. The LabVIEW driver contains the following VIs:

- **WiFiTag_Read_MAC.VI**: this VI should run first to determine the tag MAC address and also its allocated IP address. The panel VI is presented in figure 9.



Fig. 9. WiFiTag_ReadMAC.VI

- **WiFiTag_Read_Temperature.VI:** this VI returns the temperature reading from a tag's thermistor. The panel VI is presented in figure 10.

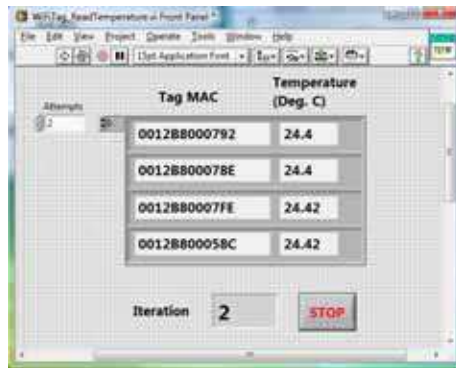

Fig. 10. WiFiTag_ReadTemperature.VI

- **WiFiTag_Read_RSSI.VI:** this VI returns tag RSSI value with regard to the AP. You can calculate the distance in meters between the tag and the associated AP based on the RSSI reading (Folea & Ghercioiu, 2008).
- **WiFiTag_Read_BatteryVoltage.VI:** this VI returns the tag battery voltage.
- **WiFiTag_Read_0-10V.VI:** this VI returns voltage value read from tag channel 0-10V. The panel VI is presented in figure 11.

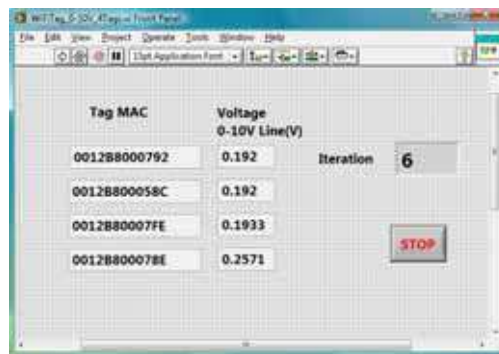

Fig. 11. WiFiTag_0-10V_4Tags VI

- **WiFiTag_Read_4-20mA.VI:** this VI returns current red from tag channel 4-20mA.
- **WiFiTag_Read_AI012.VI:** this VI returns (low) voltage red from tag channels AI0, AI1, and AI2.
- **WiFiTag_Read_DIO.VI:** this VI returns the binary values of tag digital lines DIO0, 1, 2 and 3.
- **WiFiTag_Change_SleepTime.VI:** this VI sets sleep time and receive time in tag firmware. This VI is a write (to tag) type VI.

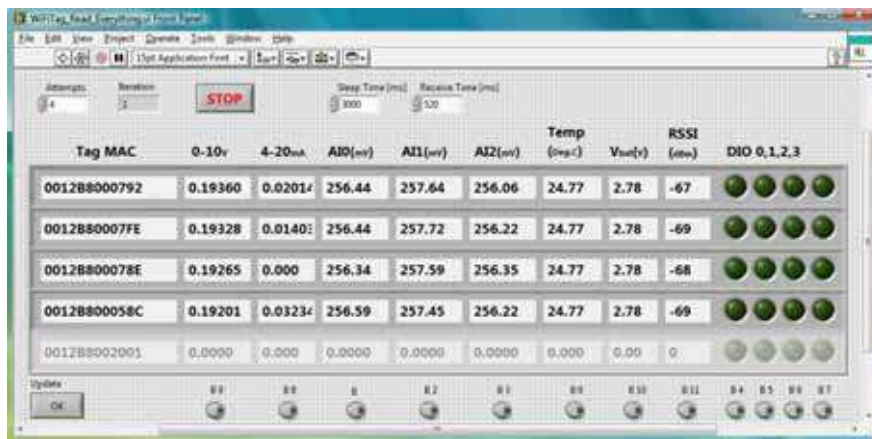

Fig. 12. LabVIEW Instrument Example

The Run WiFiTag_Read_Everything VI which includes all the previously described tasks under one panel is presented in figure 12.

The tag LabVIEW Driver offers a Calibration VI which allows the user to calculate calibration constants and write them to either tag NVR memory for testing or tag EEPROM for permanent storage.

3.4 C++ tag instrument

A C++ tag instrument was developed for users that do not have the LabVIEW programming environment installed in their computer. This instrument when run it opens its panel and displays the tags that are powered with measurements and sleep time, very similar to the web instrument. The C++ instrument example is presented in figure 13.



Fig. 13. C++ Instrument Example

3.5 Calibration program

The LabVIEW Calibration VI was developed as a tool that can be used from inside the LabVIEW environment to re-calibrate the tag. This VI calculates and writes to tag EEPROM calibration coefficients - offset and slope - for all measurements and their associated tag channels.

The application panel for calibration VI is presented in figure 14.

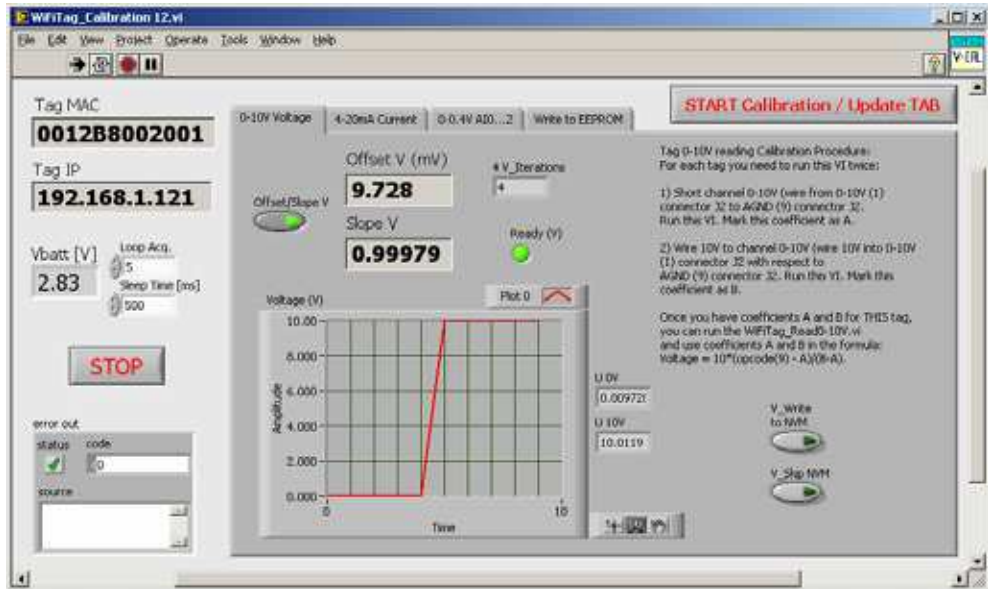

Fig. 14. LabVIEW Calibration Program

The LabVIEW diagram for calibration VI is presented in figure 15 and is an example of LabVIEW graphical programming used.

4. Applications

Wi-Fi tags are used in applications where there is a need for a small wireless tag that can do measurements and can send data to the network (Morariu et al., 2009). The following is a list of such applications:

- Patience monitoring: tremors, heart pulse, temperature, arterial tension.
- Environment: temperature, humidity, light, sound, infrared, barometer, beta and gamma radiation.
- Defence-related sensor networks: battlefield surveillance, treaty monitoring, transportation monitoring.
- Inventory Control: know where your products are and their status.
- Product quality monitoring:
 - Temperature, humidity, impact and vibration, weight and strain.
 - Failure analysis and diagnostic information.

Most of these applications require that a certain sensor or set of sensors is attached to tag measurement lines. For some applications a small extension or attachment board can be

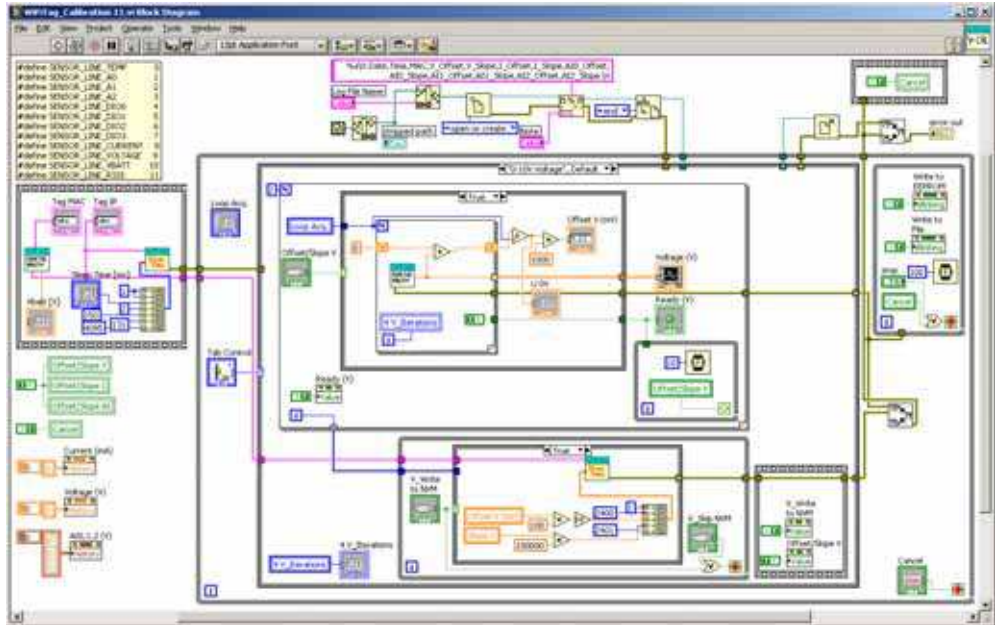

Fig. 15. LabVIEW Calibration Program - diagram

built that contains the sensor, sensor conditioning and power circuitry all on a small PCB. This section presents some of the sensor extension boards that were designed with the idea of showing tag users some examples of what can be done.

4.1 RS232 interface to PC

The RS232 tag extension is used to connect a PC to the tag via RS-232 cable. The RS232 extension board presented in Figure 16 contains a MAX3221 line driver/receiver and a DB9 connector. This extension module can be used to read data from the tag into a PC with the purpose of debugging the application software. A very similar module containing a 16-pin connector, Reset and Wake_Up buttons is used for downloading firmware into the tag.

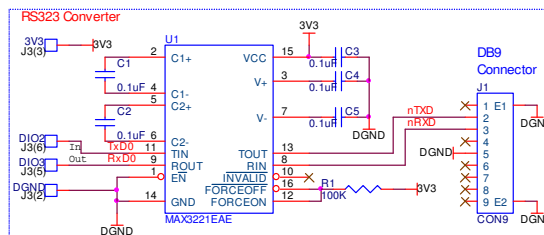

Fig. 16. RS232 Interface to PC

4.2 External power supply

The External Power Supply tag extension presented in Figure 17 is a special connector that allows external power to be connected to the tag.

The external power supply option is needed for power hungry applications like those with a high data acquisition rate and very short sleep time, or with a continuous output that is generated by the tag and needs to be maintained.

The external power voltage range is between +1.8...+3.3V with +3.7V as absolute maximum value and 1A current capability. The tag battery should not be connected if external power is used.

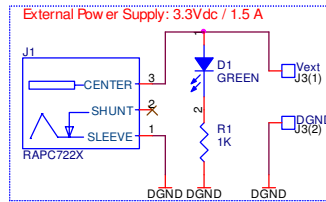

Fig. 17. The Tag4M External Power Supply

4.3 Temperature and humidity sensor

The Temperature and Humidity Sensor extension presented in Figure 18 is used to measure ambient temperature and humidity in the tag vicinity.

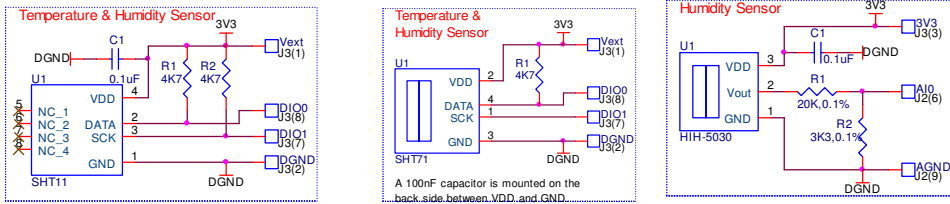

Fig. 18. Temperature and Humidity (SHT11/71) and Humidity (HIH-5030) Sensors

The three different sensors for this type of application were investigated: SHT11 and SHT71 for temperature and humidity and HIH-5030 for humidity only.

SHT11 and SHT71 are digital sensors with an I2C bus for communication. These sensors are very accurate but also more expensive than a thermocouple or RTD (Resistance Temperature Detector). The I2C interface between the sensor and the tag is relatively slow, you can make a reading every 3 seconds (Sensirion, 2005). The HIH-5030 is an analog sensor (voltage) which means it is faster. Generally speaking the tag performs faster readings when sensor output is current or voltage (Honeywell, 2009).

For RTD sensors like the PT100 or 1...10kohm NTC thermistors the internal current generator on lines AI0, 1, 2 can be activated for excitation (G2 Microsystems, 2008 b).

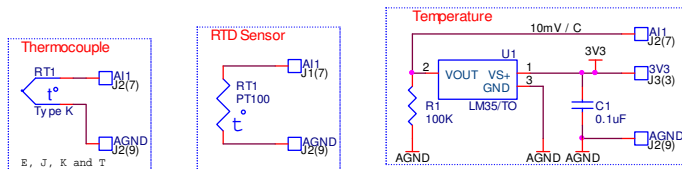

Fig. 19. Temperature: Thermocouple (Type K), RTD (PT100) and LM35 Sensors

The LM35 temperature sensor, Figure 19 right, allows for temperature measurement in the 0-100°C range, generating an output voltage of 10mV/°C, which is proportional with the temperature value. This circuit does not need further calibration and it is quite precise at $\pm 1/4^\circ\text{C}$ at 20°C (National Semiconductor, 2000).

4.4 Light and pressure sensor

The Light Sensor extension presented in Figure 20 is used to measure ambient light in the tag vicinity. The sensor used to measure light intensity is LX1972, a low cost silicon light sensor with spectral response that closely emulates the human eye. Sensor circuitry produces peak spectral response at 520nm, with IR response less than $\pm 5\%$, of the peak response, above 900nm. Usable ambient light conditions range is from 1 to more than 5000 Lux (Microsemi, 2005).

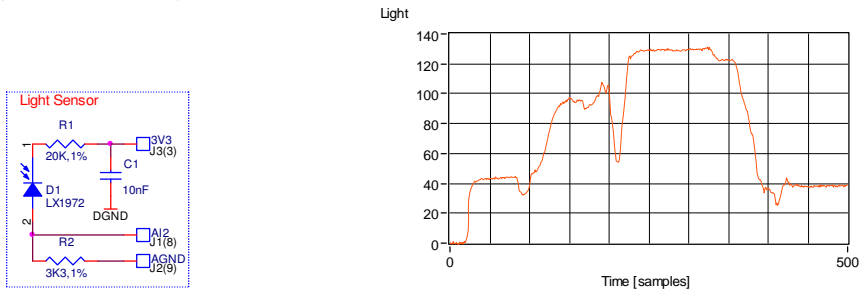

Fig. 20. Light Sensor and Signal

The Pressure Sensor extension is used to measure atmospheric pressure in weather applications. The board mounts the MPX5100 pressure sensor and signal conditioning circuitry as shown in Figure 21 (Freescale Semiconductor, 2009). Here is an example of measured atmospheric pressure for a period of 2 hours.

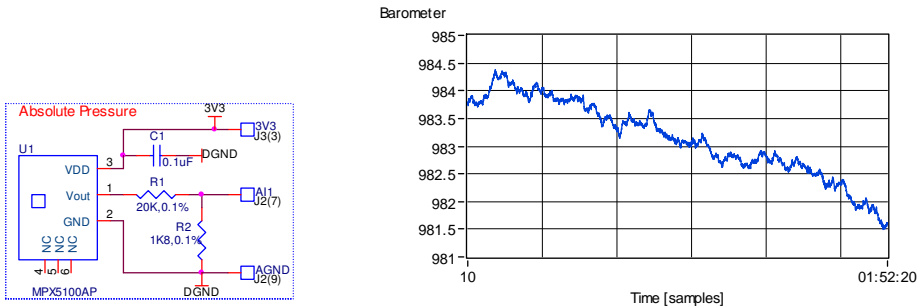

Fig. 21. Pressure Sensor and Signal

4.5 Volt free input and output

The Volt Free Input extension presented in Figure 22 is used to detect if contacts are closed or open. This extension board does not need external components or power supply to complete the circuit with exception of a contact, open or close connection.

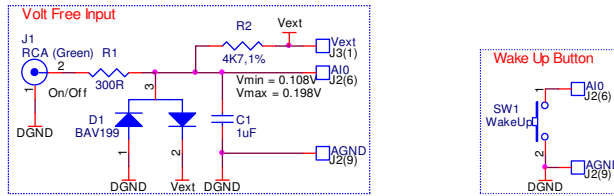

Fig. 22. Volt Free Input and Wake Up Button

The wake up button implementation is a cheaper version of the volt free input board, which does not offer protection against signal spikes.

The Volt Free Output extension presented in Figure 23 is used to control a light source, AC/DC motor, etc. The extension board circuitry is based on a solid state relay AOV202A that works in both AC and DC at 60V, 0.4A, and has optical isolation (Panasonic, 2005).

The external latch, TC7WH74 IC, is necessary to keep the output unchanged while the tag is in sleep mode which sets signal lines CLK and VFO to floating state (Toshiba, 2001).

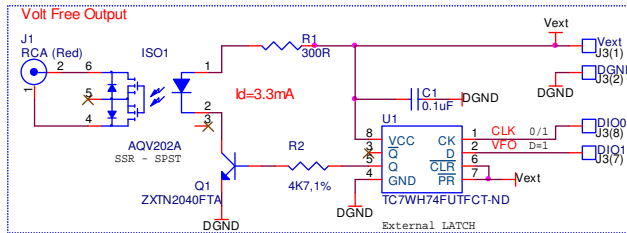

Fig. 23. Volt Free Output

The Volt Free Output extension is only recommended for applications where an external power supply is used.

4.6 Voltage input

The 0-10V Voltage Input extension presented in Figure 24 is connected to low-voltage signal lines AI0, 1, 2 in order to extend their measurement range to 0-10V. This extension increases the number of 0-10V channels to 4 for one tag.

The analogue voltage input range on this extension board is easy to change to almost any range. The circuitry implements over voltage protection too.

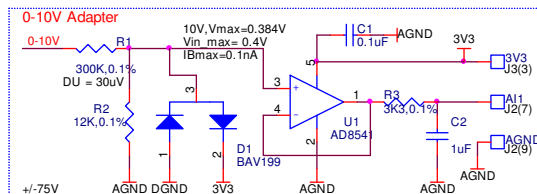

Fig. 24. 0-10V Voltage Input Circuit

The voltage conversion formula from 0-10V in 0-0.4V is (1):

$$U_{AI} = V_{[0-10V]} \cdot \frac{R_2}{R_1 + R_2} [V] \tag{1}$$

Where $R_1=300k\Omega$, 0.1% and $R_2=12k\Omega$, 0.1% are the input divider resistors. This circuitry implements a divider by 26 which is implemented using two precision resistors and with the AD8541 IC, a low input current (4pA) rail-to-rail amplifier (Analog Devices, 2008).

4.7 Current input

The 4-20mA Current Input extension presented in Figure 25 is used to convert current to voltage in order to allow current signals from sensors to be read by using tag voltage channels.

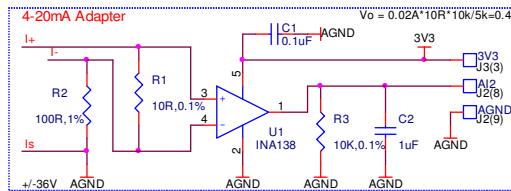

Fig. 25. 4-20 mA Current Input Circuit

The current-to-voltage conversion formula from 4-10mA to 0-0.4V is (2):

$$U_{AI} = I_{[4-20mA]} \cdot R_1 \cdot 2 [V] \tag{2}$$

Where $R_1=10\Omega$, 0.1% is the measurement resistor which needs to be very precise. The current to voltage converter is implemented using the INA138 IC which has a wide input common-mode voltage range, low quiescent current and tiny SOT23 packaging enable used in a variety of applications (Burr-Brown, 2005).

4.8 Tilt Sensor

The Tilt Sensor extension presented in Figure 26 is used to detect tilt. This extension is built using the SQ-SEN-200 series sensor. The tilt sensor acts like a normally closed switch which chatters open and closed as it is tilted or vibrated. Unlike other rolling-ball sensors, the SQ-SEN-200 is truly an omnidirectional movement sensor. It will function regardless of how it is mounted or aligned (SignalQuest, 2009).

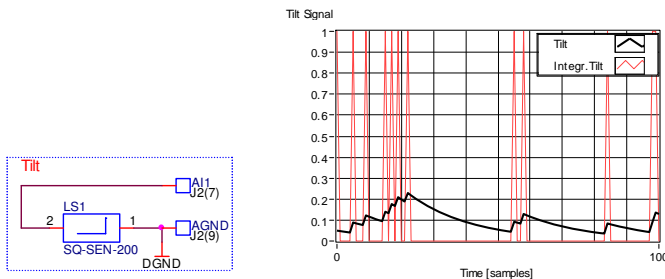

Fig. 26. Tilt Sensor

Each edge coming from the switch signal is software integrated to obtain the function shown in Figure 26, right (SignalQuest, 2006).

4.9 3-Axis acceleration sensor

The 3-Axis Acceleration Sensor extension presented in Figure 27 is used to detect position and to a lesser extent to calculate acceleration.

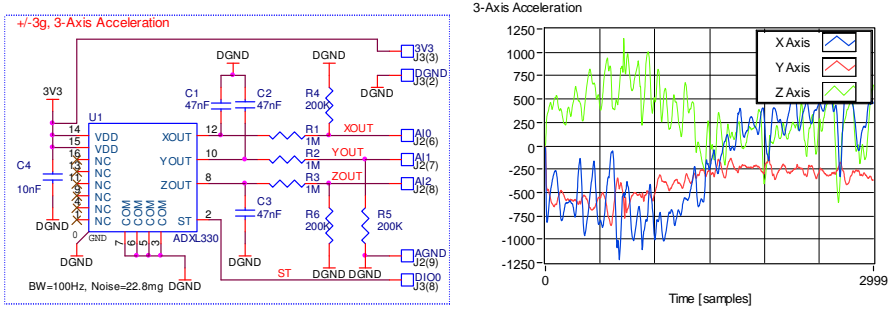

Fig. 27. 3-Axis Acceleration Sensor, Schematic and Output Signal

The ADXL330 (Figure 27) was used in experiments. It is an acceleration sensor of iMEMS type, from Analog Devices. This sensor allows measurement of static or dynamic acceleration on three axes, in the range of $\pm 3g$. External components are used to hardware set output signal period in the range of 2 to 1000ms, frequency being limited to the range of 0.5Hz to 1.6kHz. Typical sensor noise level is $280\mu g/\sqrt{Hz}$ rms which allows for a precision of less than 5mg level. The extension can also be used for vibrations measurement (Analog Devices, 2009).

Possible applications of the Wi-Fi tag with the 3-Axis Acceleration Sensor extension are the stud of different types of tremors, in a health telematic network. An experimental, wireless tremor telemonitoring system could be implemented. The system is composed of an optional number of portable devices integrating three-axis acceleration mini-sensors which are connected to Wi-Fi tags with transmission capabilities. The main advantages of the design system consist of the possibilities to monitor simultaneously many body parts of one or multiple subjects on local or more extended areas both for scheduled assessments and in an everyday life environment (Bilodeau et al., 2007).

4.10 LEDs, buzzer output and 8-Bit expander

The LED and Buzzer output extensions presented in Figure 28 are used to visualize DIO lines states and to create a buzzer sound. The LED extension board contains LEDs connected

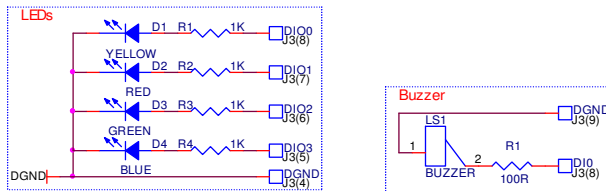

Fig. 28. LEDs and buzzer output

to tag digital outputs lines via current limitation resistors. An auto-oscillated buzzer is used on the Buzzer extension.

The Programmable Expander board presented in Figure 29 can be used in applications where a large number of digital input/output lines are used.

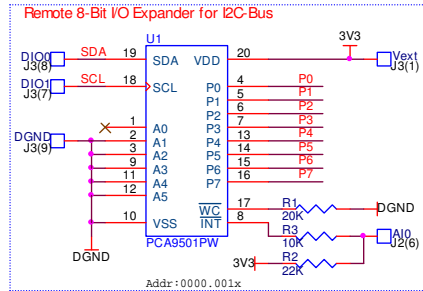

Fig. 29. Remote 8-Bit IO Expander for I2C Bus

The I/O expandable eight quasi-bidirectional data pins can be independently assigned as inputs or outputs to monitor board level status or activate indicator devices such as LEDs. The data for each input or output is kept in the corresponding input or output register (NXP, 2009).

The PCA9501 active LOW open-drain interrupt output is activated when any input state differs from its corresponding input port register state. It is used to indicate that at a certain time an input state has changed and the device needs to be interrogated.

The PCA9501 has six address pins with internal pull-up resistors allowing up to 64 devices to share the common two-wire I2C-bus software protocol serial data bus.

4.11 Microphone and PIR

The Microphone extension board presented in Figure 30 is used to capture sound. Security applications may use sound intensity for alarm condition detection. In Figure 30 right, is presented the first experiment that use sound capture, where there is a longer period of sound.

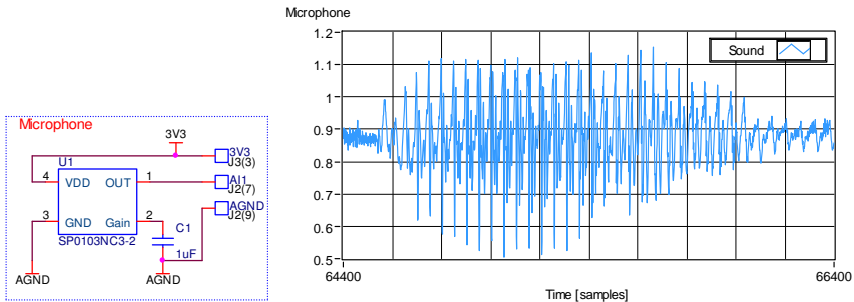

Fig. 30. Microphone, Schematic and Signal

In Figure 31 is presented the second experiment that use sound capture, where the sound period is very short, as in one clap of the hands.

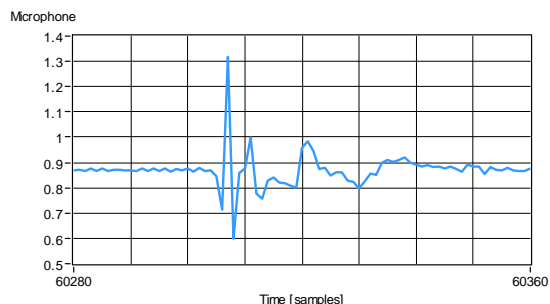

Fig. 31. Microphone Signal

The PIR extension board presented in Figure 32 is used to capture movement. The extension board mounts the AMN41122 sensor. This sensor detects changes in infrared radiation caused by a person’s movement (or an object’s movement) which has a different temperature from the surroundings (Panasonic, 2006).

The sensor output is digital, and its current consumption is very low in the range (46...60uA). The sensor outputs current up to 100uA.

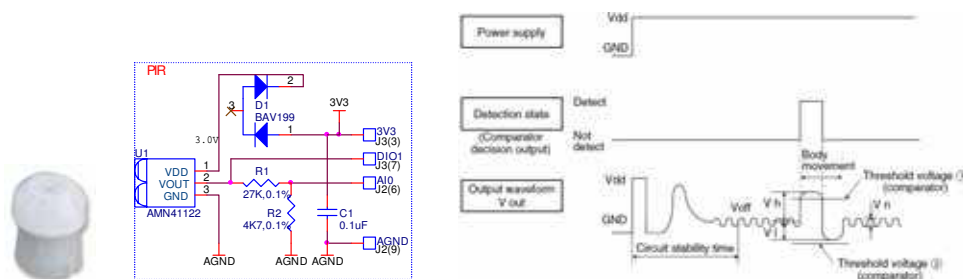

Fig. 32. PIR detector, Schematic and Signal Output

4.12 USB to serial interface

The USB to Serial extension board presented in Figure 33 is used to connect to the tag using the USB interface. The USB interface is capable of powering the tag with up to 500mA.

The FT232R was used. It is a USB to serial UART interface device which simplifies USB to serial designs and reduces external component count by fully integrating an external EEPROM, USB termination resistors and an integrated clock circuit which requires no external crystal, into the device (FTDI, 2009).

Tag applications with continuous high sample analog input rate require more power and therefore are well suited for using the USB to RS232 extension board.

5. Conclusions

This presentation introduces a Wi-Fi tag named Tag4M. The novelty of the design is Wi-Fi with ultra-low power, in a very small package that is running on a battery for years and offers a platform for sensor measurements using the existing (Internet) network

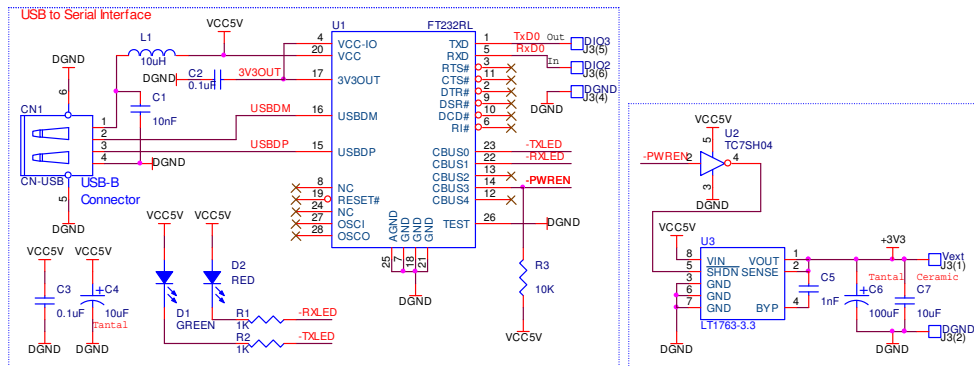

Fig. 33. USB to Serial Interface and +3.3 V, 500 mA LDO

infrastructure. The tag firmware contains communication and measurement commands implemented in the radio microcontroller. The tag has application software support for WEB pages, LabVIEW and C++ instruments.

Sensors can be directly attached to the tag I/O connector or to tag extension boards that may contain conditioning and power circuitry. Several of these dedicated tag extension boards were presented with the idea of showing what can be done in terms of sensor connectivity to the tag in applications for temperature, light, movement, sound, vibration, etc. The tag has its own limitations mostly related to battery power consumption. Data acquisition rate has to be below 30kSps, and tag not being well suited for video applications or very fast and deterministic real time control applications.

For future research is targeted developing portable instruments based on this platform and also integrating the tag in devices used by industrial applications.

6. References

- Analog Devices, (2008). *General-Purpose CMOS Rail-to-Rail Amplifiers*, Technical Report, pp. 1-3, www.analog.com
- Analog Devices (2009). *Small, Low Power, 3-Axis $\pm 3g$ iMEMS Accelerometer*, pp. 1-16, D05677-0-6/07(A), pp. 1-4, www.analog.com
- Bilodeau, M., Bisson, E., DeGrace, D., Despres, I., & Johnson, M. (2007). *Muscle activation characteristics associated with differences in physiological tremor amplitude between the dominant and non-dominant hand*. Journal of Electromyography and Kinesiology, vol.: 19. Elsevier Publisher. pp. 131-138.
- Burr-Brown, (2005). *High-Side Measurement Current Shunt Monitor*, Sbos122c - December 1999 - Revised November 2005, pp. 1-10
- Folea, S. & Ghercioiu, M. (2008). *Ultra-Low Power Wi-Fi Tag for Wireless Sensing*, Automation, Quality and Testing, Robotics, AQTR 2008, IEEE International Conference on Volume 3, Issue , 22-25 May 2008, pp. 247 - 252, ISBN: 978-1-4244-2576-1, Cluj-Napoca, Romania

- Freescale Semiconductor, (2009). *Integrated Silicon Pressure Sensor On-Chip Signal Conditioned, Temperature Compensated, and Calibrated*, Technical Data, pp. 1-2, Rev 12, 3/2009, Freescale Semiconductor Literature Distribution Center, Denver, Colorado 80217
- FTDI, (2009). *FT232R USB UART IC*, Datasheet Version 2.04, pp. 1-40, Future Technology Devices, International Ltd., Document No.: FT_000053
- Ghercioiu, M.; Folea, S. & Monoses, I. (2007). *The WiTAG - a WiFi Sensor TAG*, The 2007 International Conference on Wireless Networks, pp. 376-380, ISBN 1-60132-039-6, Las Vegas, Nevada, USA
- G2 Microsystems, (2008) a. *G2C547 SoC Data Sheet*, product brief, pp. 1-38, G2 Microsystems, Inc., Campbell, CA, USA
- G2 Microsystems, (2008) b. *G2C547 Software, Example Application*, pp. 1-28, G2 Microsystems, Inc., Campbell, CA, USA
- G2 Microsystems, (2008) c. *G2M5477 Wi-Fi Module Data Sheet*, product brief, pp. 1-10, G2 Microsystems, Inc., Campbell, CA, USA
- Honeywell, (2009). *HH-5030/5031 Series. Low Voltage Humidity Sensors*, product brief, pp. 1-8, 009050-1-EN IL50 GLO, Printed in USA, May 2009
- Labioud de H.; Afifi H. & De Santis, C. (2007). *Wi-Fi, Bluetooth, ZigBee and WiMAX*, pp. 1-316, Springer, ISBN: 978-1402053962, Dordrecht, Netherlands
- Microsemi, (2005). *Ambient Light Detector, LX1972*, pp. 1-9, Rev. 1.1b, 2005-10-31, pp. 1-2, www.microsemi.com
- Morariu, A.; Folea, S. & Valean, H. (2009). *Reliable Agent Based Monitoring System*, ISCA 24th International Conference On Computers And Their Applications, CATA-2009, ISBN: 978-1-880843-70-3, pp. 99-104, April 8-10, 2009, New Orleans, Louisiana, USA.
- National Semiconductor, (2000). *LM35 Precision Centigrade Temperature Sensors*, pp. 1-13, DS005516, 2000, www.national.com
- NXP, (2009). *PCA9501 8-bit I2C-bus and SMBus I/O port with interrupt, 2-kbit EEPROM and 6 address pins*, Product data sheet, pp. 1-28, Rev. 04 – 10 February 2009, www.nxp.com
- Panasonic, (2005). *Low on-resistance. Controls load voltage 40V to 400V. DC load type is available.*, Technical Report, pp. 1-5, Matsushita Electric Works, Ltd.
- Panasonic, (2006). *Motion Sensor (Passive Infrared Type)*, Technical Report, pp. 1-8, Panasonic Electric Works Co., Ltd
- Sidhu, B.; Singh, H. & Chhabra, A. (2007). *Emerging Wireless Standards - WiFi, ZigBee and WiMAX*, World Academy of Science, Engineering and Technology, volume 25, pp. 1345-1349, ISSN: 2070-3724, Sydney, Australia
- SignalQuest, (2006). *SQ-SEN-200, Application Note Digital Filter and Motion Estimation Algorithm*, pp. 1-2, 10 Water St. Lebanon, NH 03766 USA
- SignalQuest, (2009). *Datasheet Sq-Sen-200, Omnidirectional Tilt and Vibration Sensor*, pp. 1-6, 10 Water St. Lebanon, NH 03766 USA
- Sensirion, (2005). *SHT1x / SHT7x Humidity & Temperature Sensor*, v2.04 May 2005, pp. 1-9, www.sensirion.com

- Tag4M (2009). *Tag4M - The Multifunctional I/O Wi-Fi Tag*, Technical Report, Copyright 2007-2009, Austin, Texas, USA, tag4m.com
- Toshiba, (2001). *TC7WH74 Series- D-Type Flip Flop With Preset And Clear*, Technical Report, pp. 1-7, www.semicon.toshiba.co.jp

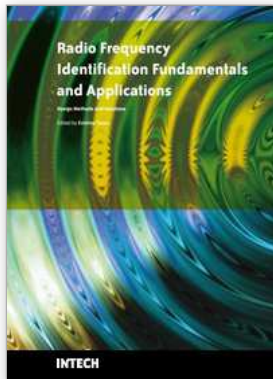

Radio Frequency Identification Fundamentals and Applications Design Methods and Solutions

Edited by Cristina Turcu

ISBN 978-953-7619-72-5

Hard cover, 324 pages

Publisher InTech

Published online 01, February, 2010

Published in print edition February, 2010

This book, entitled Radio Frequency Identification Fundamentals and Applications, Bringing Research to Practice, bridges the gap between theory and practice and brings together a variety of research results and practical solutions in the field of RFID. The book is a rich collection of articles written by people from all over the world: teachers, researchers, engineers, and technical people with strong background in the RFID area. Developed as a source of information on RFID technology, the book addresses a wide audience including designers for RFID systems, researchers, students and anyone who would like to learn about this field. At this point I would like to express my thanks to all scientists who were kind enough to contribute to the success of this project by presenting numerous technical studies and research results. However, we couldn't have published this book without the effort of InTech team. I wish to extend my most sincere gratitude to InTech publishing house for continuing to publish new, interesting and valuable books for all of us.

How to reference

In order to correctly reference this scholarly work, feel free to copy and paste the following:

Silviu Folea and Marius Ghercioiu (2010). Tag4M, a Wi-Fi RFID Active Tag Optimized for Sensor Measurements, Radio Frequency Identification Fundamentals and Applications Design Methods and Solutions, Cristina Turcu (Ed.), ISBN: 978-953-7619-72-5, InTech, Available from:
<http://www.intechopen.com/books/radio-frequency-identification-fundamentals-and-applications-design-methods-and-solutions/tag4m-a-wi-fi-rfid-active-tag-optimized-for-sensor-measurements>

INTECH

open science | open minds

InTech Europe

University Campus STeP Ri
Slavka Krautzeka 83/A
51000 Rijeka, Croatia
Phone: +385 (51) 770 447
Fax: +385 (51) 686 166
www.intechopen.com

InTech China

Unit 405, Office Block, Hotel Equatorial Shanghai
No.65, Yan An Road (West), Shanghai, 200040, China
中国上海市延安西路65号上海国际贵都大饭店办公楼405单元
Phone: +86-21-62489820
Fax: +86-21-62489821

© 2010 The Author(s). Licensee IntechOpen. This chapter is distributed under the terms of the [Creative Commons Attribution-NonCommercial-ShareAlike-3.0 License](#), which permits use, distribution and reproduction for non-commercial purposes, provided the original is properly cited and derivative works building on this content are distributed under the same license.