

# Digital Stabilization of Fuzzy Systems with Time-Delay and Its Application to Backing up Control of a Truck-Trailer

Chang-Woo Park  
*Korea Electronics Technology Institute (KETI),  
401-402 B/D 193, Yakdae-Dong, Wonmi-Gu, Puchon-Si, Kyunggi-Do, 420-734,  
Korea*

## 1. Introduction

The control problems for delayed systems have attention over the last few decades since the time-delay is frequently a source of instability and encountered in various engineering systems. Extensive research has already been done in the conventional control to find the solutions [1][2]. However, for fuzzy control systems, there are few studies on the stabilization problem for especially systems with time-delay[3][4]. A linear controller like PID controllers has a short time-delay in calculating the output since its algorithm is so simple. However, in the case of a complex algorithm like fuzzy or neural networks, a considerable time-delay can occur because so many calculations are needed to get the output. Nevertheless, the most conventional discrete time fuzzy controllers are the ideal controllers in which the time-delay is not considered. Recently, to deal with the time-delay, the design methods of the fuzzy control systems with higher order have been proposed in [5]. However the structure of the control system is very complex because the design of higher order fuzzy rule-base is highly difficult.

In this chapter, the digital fuzzy control system considering a time delay is developed and its stability analysis and design method are proposed. We use the discrete Takagi-Sugeno(TS) fuzzy model and parallel distributed compensation(PDC) conception for the controller[6-9]. And we follow the linear matrix inequality(LMI) approach to formulate and solve the problem of stabilization for the fuzzy controlled systems with time-delay. The analysis and the design of the discrete time fuzzy control systems by LMI theory are considered in [10-12].

If the system has a considerable time-delay the analysis and the design of the controller are very difficult since the time-delay makes the output of the controller not synchronized with the sampling time. We propose the PDC-type fuzzy feedback controller whose output is delayed with unit sampling period and predicted using current states and the control input to the plant at previous sampling time. The analysis and the design of the controller are very easy because the output of the proposed controller is synchronized with the sampling time. Therefore, the proposed control system can be designed using the conventional methods for stabilizing the discrete time fuzzy systems and the feedback gains of the controller can be obtained using the concept of the LMI feasibility problem.

Source: Fuzzy Systems, Book edited by: Ahmad Taher Azar,  
ISBN 978-953-7619-92-3, pp. 216, February 2010, INTECH, Croatia, downloaded from SCIYO.COM

The proposed DFC is applied to backing up control of a computer-simulated truck-trailer with time-delay to verify the validity and the effectiveness of the control scheme. Note that the term "Digital fuzzy control system" is used to emphasize the proposed aspect corresponding to the existing "Discrete time fuzzy system".

## 2. Discrete TS model based fuzzy control

In the discrete time TS fuzzy systems without control input, the dynamic properties of each subspace can be expressed as the following fuzzy IF-THEN rules[6].

$$\begin{aligned} \text{Rule } i: & \text{ If } x_1(k) \text{ is } M_{i1} \cdots \text{ and } x_n(k) \text{ is } M_{in} \quad i = 1, 2, \dots, r \\ & \text{ THEN } \mathbf{x}(k+1) = \mathbf{G}_i \mathbf{x}(k) \end{aligned} \quad (1)$$

where  $\mathbf{x}(k) = [x_1(k) \ x_2(k) \ \cdots \ x_n(k)]^T \in \mathfrak{R}^n$  denotes the state vector of the fuzzy system,  $r$  is the number of the IF-THEN rules, and  $M_{ij}$  is fuzzy set.

If the state  $\mathbf{x}(k)$  is given, the output of the fuzzy system expressed as the fuzzy rules of Eq. (1) can be inferred as follows.

$$\mathbf{x}(k+1) = \frac{\sum_{i=1}^r w_i(k) \mathbf{G}_i \mathbf{x}(k)}{\sum_{i=1}^r w_i(k)} = \sum_{i=1}^r h_i(k) \mathbf{G}_i \mathbf{x}(k) \quad (2)$$

$$\text{where } w_i(k) = \prod_{j=1}^n M_{ij}(x_j(k)), \quad h_i(k) = \frac{w_i(k)}{\sum_{i=1}^r w_i(k)}$$

A sufficient condition for ensuring the stability of the fuzzy system(2) is given in **Theorem 1**.  
**Theorem 1:** The equilibrium point for the discrete time fuzzy system (2) is asymptotically stable in the large if there exists a common positive definite matrix  $\mathbf{P}$  satisfying the following inequalities.

$$\mathbf{G}_i^T \mathbf{P} \mathbf{G}_i - \mathbf{P} < \mathbf{0}, \quad i = 1, 2, \dots, r \quad (3)$$

**Proof:** The proof can be given in [7].

In the discrete time fuzzy system with control input to the plant, the dynamic properties of each subspace can be expressed as the following fuzzy IF-THEN rules.

$$\begin{aligned} \text{Rule } i: & \text{ If } x_1(k) \text{ is } M_{i1} \cdots \text{ and } x_n(k) \text{ is } M_{in} \quad i = 1, 2, \dots, r \\ & \text{ THEN } \mathbf{x}(k+1) = \mathbf{A}_i \mathbf{x}(k) + \mathbf{B}_i \mathbf{u}(k) \end{aligned} \quad (4)$$

where

$\mathbf{x}(k) = [x_1(k) \ x_2(k) \ \cdots \ x_n(k)]^T \in \mathfrak{R}^n$  denotes the state vector of the fuzzy system.

$\mathbf{u}(k) = [u_1(k) \ u_2(k) \ \cdots \ u_m(k)]^T \in \mathfrak{R}^m$  denotes the input of the fuzzy system.

$r$  is the number of the fuzzy IF-THEN rules, and  $M_{ij}$  is the fuzzy set.

If the set of  $(\mathbf{x}(k), \mathbf{u}(k))$  is given the output of the fuzzy system (4) can be obtained as follows.

$$\mathbf{x}(k+1) = \frac{\sum_{i=1}^r w_i(k) \{\mathbf{A}_i \mathbf{x}(k) + \mathbf{B}_i \mathbf{u}(k)\}}{\sum_{i=1}^r w_i(k)} = \sum_{i=1}^r h_i(k) \{\mathbf{A}_i \mathbf{x}(k) + \mathbf{B}_i \mathbf{u}(k)\} \quad (5)$$

where

$$w_i(k) = \prod_{j=1}^n M_{ij}(x_j(k)), \text{ and } h_i(k) = \frac{w_i(k)}{\sum_{i=1}^r w_i(k)}.$$

In PDC, the fuzzy controller is designed distributively according to the corresponding rule of the plant[9]. Therefore, the PDC for the plant (4) can be expressed as follows.

$$\begin{aligned} \text{Rule } j: & \text{ If } x_1(k) \text{ is } M_{j1} \cdots \text{ and } x_n(k) \text{ is } M_{jn} \quad j = 1, 2, \dots, r \\ & \text{ THEN } \mathbf{u}(k) = -\mathbf{F}_j \mathbf{x}(k) \end{aligned} \quad (6)$$

The fuzzy controller output of Eq. (6) can be inferred as follows.

$$\mathbf{u}(k) = -\frac{\sum_{i=1}^r w_i(k) \mathbf{F}_i \mathbf{x}(k)}{\sum_{i=1}^r w_i(k)} = -\sum_{j=1}^r h_j(k) \mathbf{F}_j \mathbf{x}(k) \quad (7)$$

where  $h_j(k)$  is the same function in Eq. (5).

Substituting Eq. (7) into Eq. (5) gives the following closed loop discrete time fuzzy system.

$$\mathbf{x}(k+1) = \sum_{i=1}^r h_i(k) \{\mathbf{A}_i \mathbf{x}(k) - \mathbf{B}_i \sum_{j=1}^r h_j(k) \mathbf{F}_j \mathbf{x}(k)\} = \sum_{i=1}^r \sum_{j=1}^r h_i(k) h_j(k) \{\mathbf{A}_i - \mathbf{B}_i \mathbf{F}_j\} \mathbf{x}(k) \quad (8)$$

Defining  $\mathbf{G}_{ij} = \mathbf{A}_i - \mathbf{B}_i \mathbf{F}_j$ , the following equation is obtained.

$$\mathbf{x}(k+1) = \sum_{i=1}^r h_i(k) h_i(k) \mathbf{G}_{ii} \mathbf{x}(k) + 2 \sum_{i < j}^r h_i(k) h_j(k) \left\{ \frac{\mathbf{G}_{ij} + \mathbf{G}_{ji}}{2} \right\} \mathbf{x}(k) \quad (9)$$

Applying **Theorem 1** to analyze the stability of the discrete time fuzzy system (9), the stability condition of **Theorem 2** can be obtained.

**Theorem 2 :** The equilibrium point of the closed loop discrete time fuzzy system (9) is asymptotically stable in the large if there exists a common positive definite matrix P which satisfies the following inequalities for all  $i$  and  $j$  except the set  $(i, j)$  satisfying  $h_i(k) \cdot h_j(k) = 0$ .

$$\mathbf{G}_{ii}^T \mathbf{P} \mathbf{G}_{ii} - \mathbf{P} < \mathbf{0} \quad (10a)$$

$$\left( \frac{\mathbf{G}_{ij} + \mathbf{G}_{ji}}{2} \right)^T \mathbf{P} \left( \frac{\mathbf{G}_{ij} + \mathbf{G}_{ji}}{2} \right) - \mathbf{P} \leq \mathbf{0}, \quad i < j \quad (10b)$$

**Proof :** The proof can be given in [7].

If  $\mathbf{B} = \mathbf{B}_1 = \mathbf{B}_2 = \dots = \mathbf{B}_r$  in the plant (5) is satisfied, the closed loop system (8) can be obtained as follows.

$$\mathbf{x}(k+1) = \sum_{i=1}^r h_i(k) \{ \mathbf{A}_i \mathbf{x}(k) - \mathbf{B} \sum_{j=1}^r h_j(k) \mathbf{F}_j \mathbf{x}(k) \} = \sum_{i=1}^r h_i(k) \{ \mathbf{A}_i - \mathbf{B} \mathbf{F}_i \} \mathbf{x}(k) = \sum_{i=1}^r h_i(k) \mathbf{G}_i \mathbf{x}(k) \quad (11)$$

where  $\mathbf{G}_i = \mathbf{A}_i - \mathbf{B} \mathbf{F}_i$

Hence, **Theorem 1** can be applied to the stability analysis of the closed loop system (11).

### 3. LMI approach for fuzzy system design

To prove the stability of the discrete time fuzzy control system by **Theorem 1** and **Theorem 2**, the common positive definite matrix  $\mathbf{P}$  must be solved. LMI theory can be applied to solving  $\mathbf{P}$  [13]. LMI theory is one of the numerical optimization techniques. Many of the control problems can be transformed into LMI problems and the recently developed Interior-point method can be applied to solving numerically the optimal solution of these LMI problems[14].

**Definition 1:** Linear matrix inequality can be defined as follows.

$$\mathbf{F}(\mathbf{x}) = \mathbf{F}_0 + \sum_{i=1}^m x_i \mathbf{F}_i > \mathbf{0} \quad (12)$$

where  $\mathbf{x} = [x_1 \quad x_2 \quad \dots \quad x_m]^T$  is the parameter, the symmetric matrices  $\mathbf{F}_i = \mathbf{F}_i^T \in \mathfrak{R}^{n \times n}$ ,  $i = 0, \dots, m$  are given, and the inequality symbol " $> \mathbf{0}$ " means that  $\mathbf{F}(\mathbf{x})$  is the positive definite matrix.

LMI of Eq. (12) means the convex constraints for  $\mathbf{x}$ . Convex constraint problems for the various  $\mathbf{x}$  can be expressed as LMI of Eq. (12). LMI feasibility problem can be described as follows.

**LMI feasibility problem:** The problem of finding  $\mathbf{x}^{\text{feasp}}$  which satisfies  $\mathbf{F}(\mathbf{x}^{\text{feasp}}) > \mathbf{0}$  or proving the unfeasibility in the case that LMI  $\mathbf{F}(\mathbf{x}) > \mathbf{0}$  is given.

And the stability condition of **Theorem 1** can be transformed into the LMI feasibility problem as follows.

**LMI feasibility problem about the stability condition of Theorem 1 :** The problem of finding  $\mathbf{P}$  which satisfies the LMI's,  $\mathbf{P} > \mathbf{0}$  and  $\mathbf{G}_i^T \mathbf{P} \mathbf{G}_i - \mathbf{P} < \mathbf{0}$ ,  $i = 1, 2, \dots, r$  or proving the unfeasibility in the case that  $\mathbf{A}_i \in \mathfrak{R}^{n \times n}$ ,  $i = 1, 2, \dots, r$  are given.

If the design object of a controller is to guarantee the stability of the closed loop system (5), the design of the PDC fuzzy controller(7) is equivalent to solving the following LMI feasibility problem using Schur complements[13].

*LMI feasibility problem equivalent to the PDC design problem (Case I)* : The problem of finding  $\mathbf{X} > \mathbf{0}$  and  $\mathbf{M}_1, \mathbf{M}_2, \dots, \mathbf{M}_r$  which satisfy the following inequalities.

$$\begin{bmatrix} \mathbf{X} & \{\mathbf{A}_i\mathbf{X} - \mathbf{B}_i\mathbf{M}_i\}^T \\ \mathbf{A}_i\mathbf{X} - \mathbf{B}_i\mathbf{M}_i & \mathbf{X} \end{bmatrix} > \mathbf{0}, \quad i = 1, 2, \dots, r$$

$$\begin{bmatrix} \mathbf{X} & 1/2\{\mathbf{A}_i\mathbf{X} + \mathbf{A}_j\mathbf{X} - \mathbf{B}_i\mathbf{M}_i - \mathbf{B}_j\mathbf{M}_j\}^T \\ 1/2\{\mathbf{A}_i\mathbf{X} + \mathbf{A}_j\mathbf{X} - \mathbf{B}_i\mathbf{M}_i - \mathbf{B}_j\mathbf{M}_j\} & \mathbf{X} \end{bmatrix} > \mathbf{0}, \quad i < j$$

where  $\mathbf{X} = \mathbf{P}^{-1}$ ,  $\mathbf{M}_1 = \mathbf{F}_1\mathbf{X}$ ,  $\mathbf{M}_2 = \mathbf{F}_2\mathbf{X}$ , ..., and  $\mathbf{M}_r = \mathbf{F}_r\mathbf{X}$ .

The feedback gain matrices  $\mathbf{F}_1, \mathbf{F}_2, \dots, \mathbf{F}_r$  and the common positive definite matrix  $\mathbf{P}$  can be given by the LMI solutions,  $\mathbf{X}$  and  $\mathbf{M}_1, \mathbf{M}_2, \dots, \mathbf{M}_r$ , as follows.

$$\mathbf{P} = \mathbf{X}^{-1}, \mathbf{F}_1 = \mathbf{M}_1\mathbf{X}^{-1}, \mathbf{F}_2 = \mathbf{M}_2\mathbf{X}^{-1}, \dots, \text{ and } \mathbf{F}_r = \mathbf{M}_r\mathbf{X}^{-1}$$

If  $\mathbf{B} = \mathbf{B}_1 = \mathbf{B}_2 = \dots = \mathbf{B}_r$  is satisfied, the design of the PDC fuzzy controller(7) is equivalent to solving the following LMI feasibility problem.

*LMI feasibility problem equivalent to the PDC design problem (Case II)* : The problem of finding  $\mathbf{X} > \mathbf{0}$  and  $\mathbf{M}_1, \mathbf{M}_2, \dots, \mathbf{M}_r$  which satisfy the following equations.

$$\begin{bmatrix} \mathbf{X} & \{\mathbf{A}_i\mathbf{X} - \mathbf{B}_i\mathbf{M}_i\}^T \\ \mathbf{A}_i\mathbf{X} - \mathbf{B}_i\mathbf{M}_i & \mathbf{X} \end{bmatrix} > \mathbf{0} \quad i = 1, 2, \dots, r$$

where  $\mathbf{X} = \mathbf{P}^{-1}$ ,  $\mathbf{M}_1 = \mathbf{F}_1\mathbf{X}$ ,  $\mathbf{M}_2 = \mathbf{F}_2\mathbf{X}$ , ..., and  $\mathbf{M}_r = \mathbf{F}_r\mathbf{X}$ .

The feedback gain matrices  $\mathbf{F}_1, \mathbf{F}_2, \dots, \mathbf{F}_r$  and the common positive definite matrix  $\mathbf{P}$  can be given by the LMI solutions,  $\mathbf{X}$  and  $\mathbf{M}_1, \mathbf{M}_2, \dots, \mathbf{M}_r$ , as follows.

$$\mathbf{P} = \mathbf{X}^{-1}, \mathbf{F}_1 = \mathbf{M}_1\mathbf{X}^{-1}, \mathbf{F}_2 = \mathbf{M}_2\mathbf{X}^{-1}, \dots, \text{ and } \mathbf{F}_r = \mathbf{M}_r\mathbf{X}^{-1}$$

#### 4. Digital fuzzy control system considering time-delay

In a real control system, a considerable time-delay can occur due to a sensor and a controller. Let  $\tau$  be defined as the sum of all this time-delay. In the case of the real system, the ideal fuzzy controller of Eq. (6) can be described as follows due to the time-delay.

$$\begin{aligned} \text{Rule } j: & \text{ If } x_1(kT) \text{ is } M_{j1} \dots \text{ and } x_n(kT) \text{ is } M_{jn} \\ & \text{ THEN } \mathbf{u}(kT + \tau) = -\mathbf{F}_j\mathbf{x}(kT) \end{aligned} \quad j = 1, 2, \dots, r \quad (13)$$

Because the time-delay makes the output of controller not synchronized with the sampling time, **Theorem 1** can not be applied to this system. Therefore the analysis and the design of the controller are very difficult. In this chapter, DFC which has the following fuzzy rules is proposed to consider the time-delay of the fuzzy plant (4).

$$\begin{aligned} \text{Rule } j: & \text{ If } x_1(k) \text{ is } M_{j1} \cdots \text{ and } x_n(k) \text{ is } M_{jn} \\ & \text{ THEN } \mathbf{u}(k+1) = \mathbf{D}_j \mathbf{u}(k) + \mathbf{E}_j \mathbf{x}(k) \quad j = 1, 2, \dots, r \end{aligned} \quad (14)$$

The output of DFC (14) is inferred as follows.

$$\begin{aligned} \mathbf{u}(k+1) &= \frac{\sum_{j=1}^r w_j(k) \{ \mathbf{D}_j \mathbf{u}(k) + \mathbf{E}_j \mathbf{x}(k) \}}{\sum_{j=1}^r w_j(k)} \\ &= \sum_{j=1}^r h_j(k) \{ \mathbf{D}_j \mathbf{u}(k) + \mathbf{E}_j \mathbf{x}(k) \} \end{aligned} \quad (15)$$

The general timing diagram of fuzzy control loop is shown in Fig. 1.  $T$  is the sampling period of the control loop,  $\tau_v$  and  $\tau_c$  are the delay made by sensor system and fuzzy controller respectively. Therefore the output of the controller is applied to the plant after overall delay  $\tau = \tau_v + \tau_c$ .

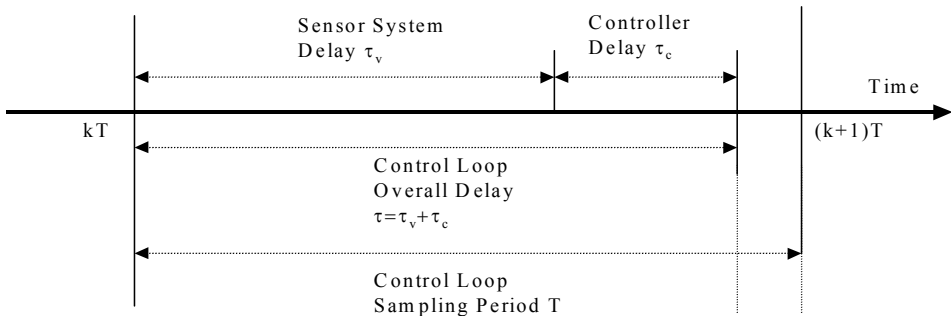

Fig. 1. Timing Diagram of the Fuzzy Control Loop

The output timing of a ideal controller, a delayed controller, and the proposed controller is shown in the Fig. 2. In the ideal controller, it is assumed that there is no time-delay. If this controller is implemented in real systems the time-delay  $\tau$  is added like Eq. (13). The analysis and the design of this system with delayed controller are very difficult since the output of controller is not synchronized with the sampling time.

On the other hand, the analysis and the design of the proposed controller are very easy because the controller output is synchronized with the sampling time delayed with unit sampling period. Using this proposed controller, we can realize a control algorithm during the time interval  $T - \tau_v$  in Fig. 1. In this time interval, a complex algorithm such as not only fuzzy algorithm but also nonlinear control algorithm can be sufficiently realized in real time.

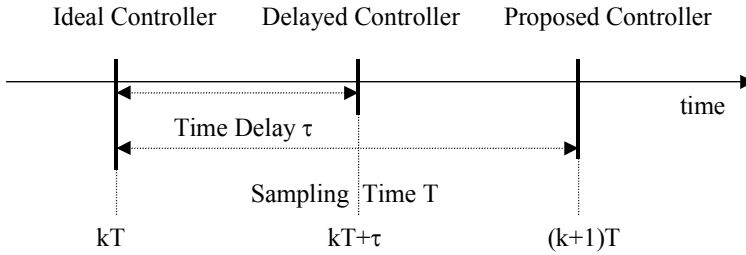

Fig. 2. Output Timing of the Controllers (three cases)

Combining the fuzzy plant (5) with the DFC (15), the closed loop system is given as follows.

$$\begin{bmatrix} \mathbf{x}(k+1) \\ \mathbf{u}(k+1) \end{bmatrix} = \sum_{i=1}^r h_i(k) \begin{bmatrix} \mathbf{A}_i & \mathbf{B}_i \\ \mathbf{E}_i & \mathbf{D}_i \end{bmatrix} \begin{bmatrix} \mathbf{x}(k) \\ \mathbf{u}(k) \end{bmatrix} \tag{16}$$

Defining the new state vector as  $\mathbf{w}(k) = \begin{bmatrix} \mathbf{x}(k) \\ \mathbf{u}(k) \end{bmatrix}$ , the closed loop system (16) can be modified as

$$\mathbf{w}(k+1) = \sum_{i=1}^r h_i(k) \mathbf{G}_i \mathbf{w}(k) \tag{17}$$

where  $\mathbf{G}_i = \begin{bmatrix} \mathbf{A}_i & \mathbf{B}_i \\ \mathbf{E}_i & \mathbf{D}_i \end{bmatrix}$

Hence, the stability condition of the closed loop system (17) becomes the same as the sufficient condition of **Theorem 1** and the stability can be determined by solving *LMI feasibility problem about the stability condition of Theorem 1*. Also, the design problem of the DFC guaranteeing the stability of the closed loop system can be transformed into *LMI feasibility problem*. To do this, the design problem of the DFC is transformed into the design problem of the PDC fuzzy controller.

**PDC design problem equivalent to DFC design problem:**

The problem of designing the PDC fuzzy controller  $\mathbf{v}(k) = -\sum_{j=1}^r h_j(k) \bar{\mathbf{F}}_j \mathbf{w}(k)$  in the case

that the fuzzy plant  $\mathbf{w}(k+1) = \sum_{i=1}^r h_i(k) \{ \bar{\mathbf{A}}_i \mathbf{w}(k) + \bar{\mathbf{B}} \mathbf{v}(k) \}$  is given.

where  $\bar{\mathbf{A}}_i = \begin{bmatrix} \mathbf{A}_i & \mathbf{B}_i \\ \mathbf{0} & \mathbf{0} \end{bmatrix}$ ,  $\bar{\mathbf{B}} = \begin{bmatrix} \mathbf{0} \\ \mathbf{I} \end{bmatrix}$ , and  $\bar{\mathbf{F}}_j = -[\mathbf{E}_j \quad \mathbf{D}_j]$

Therefore, using the same notation in section 3, the design problem of the DFC can be equivalent to the following **LMI feasibility problem**.

**LMI feasibility problem equivalent to DFC design problem:**

The problem of finding  $\mathbf{X} > \mathbf{0}$  and  $\mathbf{M}_1, \mathbf{M}_2, \dots, \mathbf{M}_r$  which satisfy following equation.

$$\begin{bmatrix} \mathbf{X} & \{\bar{\mathbf{A}}_i \mathbf{X} - \bar{\mathbf{B}} \mathbf{M}_i\}^T \\ \bar{\mathbf{A}}_i \mathbf{X} - \bar{\mathbf{B}} \mathbf{M}_i & \mathbf{X} \end{bmatrix} > \mathbf{0}, i = 1, 2, \dots, r$$

where  $\mathbf{X} = \mathbf{P}^{-1}$ ,  $\mathbf{M}_1 = \bar{\mathbf{F}}_1 \mathbf{X}$ ,  $\mathbf{M}_2 = \bar{\mathbf{F}}_2 \mathbf{X}$ , ..., and  $\mathbf{M}_r = \bar{\mathbf{F}}_r \mathbf{X}$

The feedback gain matrices  $\bar{\mathbf{F}}_1, \bar{\mathbf{F}}_2, \dots, \bar{\mathbf{F}}_r$  and the common positive definite matrix  $\mathbf{P}$  can be given by the LMI solutions,  $\mathbf{X}$  and  $\mathbf{M}_1, \mathbf{M}_2, \dots, \mathbf{M}_r$ , as follows.

$$\mathbf{P} = \mathbf{X}^{-1}, \bar{\mathbf{F}}_1 = \mathbf{M}_1 \mathbf{X}^{-1}, \bar{\mathbf{F}}_2 = \mathbf{M}_2 \mathbf{X}^{-1}, \dots, \bar{\mathbf{F}}_r = \mathbf{M}_r \mathbf{X}^{-1} \quad (18)$$

Therefore, the control gain matrices  $\mathbf{D}_1, \dots, \mathbf{D}_r, \mathbf{E}_1, \dots, \mathbf{E}_r$  of the proposed DFC can be obtained from the feedback gain matrices  $\bar{\mathbf{F}}_1, \bar{\mathbf{F}}_2, \dots, \bar{\mathbf{F}}_r$ .

**5. Backing up control of computer-simulated truck-trailer**

We have shown an analysis technique of the proposed DFC under the condition that time-delay exists in section 4. Some papers have reported that backing up control of a computer-simulated truck-trailer could be realized by fuzzy control[9][11][15][16]. However, these studies have not analyzed the time-delay effect to the control system. In this section, we apply the controller to backing up control of a truck-trailer system with time-delay.

**5.1 Models of a truck-trailer**

M. Tokunaga derived the following model about the truck-trailer system [16]. Fig. 3 shows the schematic diagram of this system.

$$\begin{aligned} x_0(k+1) &= x_0(k) + vT/l \tan[u(k)] \\ x_1(k) &= x_0(k) - x_2(k) \\ x_2(k+1) &= x_2(k) + vT/L \sin[x_1(k)] \\ x_3(k+1) &= x_3(k) + vT \cos[x_1(k)] \sin[\{x_2(k+1) + x_2(k)\}/2] \\ x_4(k+1) &= x_4(k) + vT \cos[x_1(k)] \cos[\{x_2(k+1) + x_2(k)\}/2] \end{aligned} \quad (19)$$

where

$x_0(k)$  : The angle of the truck referenced to the desired trajectory

$x_1(k)$  : The angle difference between the truck and the trailer

$x_2(k)$  : The angle of the trailer referenced to the desired trajectory

$x_3(k)$  : The vertical position of the trailer tail end

$x_4(k)$  : The horizontal position of the trailer tail end



$u(k)$  : The steering angle of the truck  
 $l$  : The length of the truck,  $L$  : The length of the trailer  
 $T$  : Sampling time,  $v$  : The constant backward speed

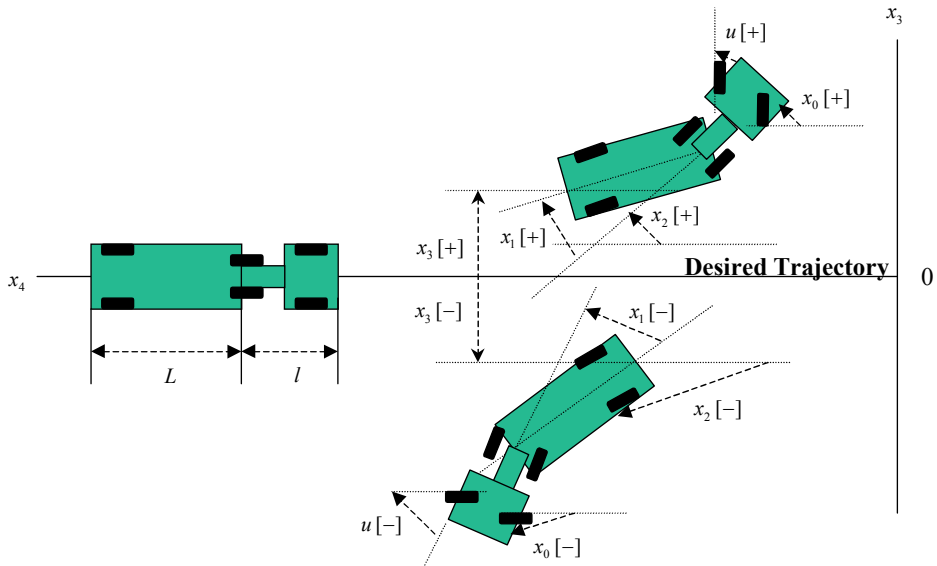

Fig. 3. Truck Trailer Model and Its Coordinate System

K. Tanaka defined the state vector as  $\mathbf{x}(k) = [x_1(k) \ x_2(k) \ x_3(k)]^T$  in the truck-trailer model (19) and expressed the plant as two following fuzzy rules[9].

$$\begin{aligned}
 \text{Rule 1 : If } x_2(k) + vT / \{2L\} x_1(k) \text{ is } M_1 \\
 \text{THEN } \mathbf{x}(k+1) = \mathbf{A}_1 \mathbf{x}(k) + \mathbf{B}_1 u(k) \\
 \text{Rule 2 : If } x_2(k) - vT / \{2L\} x_1(k) \text{ is } M_2 \\
 \text{THEN } \mathbf{x}(k+1) = \mathbf{A}_2 \mathbf{x}(k) + \mathbf{B}_2 u(k)
 \end{aligned} \tag{20}$$

where

$$\mathbf{A}_1 = \begin{bmatrix} 1 - \frac{vT}{L} & 0 & 0 \\ \frac{vT}{L} & 1 & 0 \\ \frac{v^2 T^2}{2L} & vT & 1 \end{bmatrix}, \mathbf{A}_2 = \begin{bmatrix} 1 - \frac{vT}{L} & 0 & 0 \\ \frac{vT}{L} & 1 & 0 \\ \frac{dv^2 T^2}{2L} & dvT & 1 \end{bmatrix}, \mathbf{B} = \mathbf{B}_1 = \mathbf{B}_2 = \begin{bmatrix} \frac{vT}{l} \\ 0 \\ 0 \end{bmatrix}$$

$$l = 2.8[\text{m}], L = 5.5[\text{m}], v = -1.0[\text{m/s}], T = 2.0[\text{s}], d = 10^{-2} / \pi$$

Fig. 4 shows the membership function of the premise part in the fuzzy system (20).

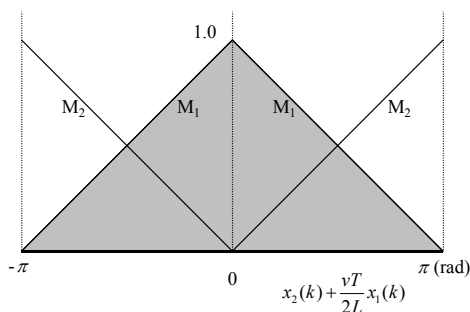

Fig. 4. Membership function

### 5.2 Discrete time fuzzy controller applied to the system with no time-delay

In this subsection, backing up control of a truck-trailer is simulated by the conventional discrete time fuzzy controller under the assumption that no time-delay exists.

To solve the backward parking problem of Eq. (20), the PDC fuzzy controller can be designed as follows.

Rule 1 : If  $x_2(k) + vT/\{2L\} \cdot x_1(k)$  is  $M_1$   
THEN  $u(k) = \mathbf{F}_1^T \mathbf{x}(k)$

Rule 2 : If  $x_2(k) + vT/\{2L\} \cdot x_1(k)$  is  $M_2$   
THEN  $u(k) = \mathbf{F}_2^T \mathbf{x}(k)$  (21)

where  $\mathbf{F}_1 = \begin{bmatrix} 1.2837 \\ -0.4139 \\ 0.0201 \end{bmatrix}$  and  $\mathbf{F}_2 = \begin{bmatrix} 0.9773 \\ -0.0709 \\ 0.0005 \end{bmatrix}$ .

Ricatti equation for linear discrete systems was used to determine these feedback gains. The detailed derivation of these feedback gains was given in [9].

Substituting Eq. (21) into Eq. (20) yields the following closed loop system due to  $\mathbf{B} = \mathbf{B}_1 = \mathbf{B}_2$ .

$$\mathbf{x}(k+1) = \sum_{i=1}^2 h_i(k) \mathbf{G}_i \mathbf{x}(k) \quad (22)$$

where

$$\mathbf{G}_1 = \begin{bmatrix} 0.448 & 0.296 & -0.014 \\ -0.364 & 1 & 0 \\ 0.364 & -2 & 1 \end{bmatrix} \text{ and } \mathbf{G}_2 = \begin{bmatrix} 0.448 & 0.296 & -0.014 \\ -0.364 & 1 & 0 \\ 0.116 \times 10^{-2} & -0.637 \times 10^{-2} & 1 \end{bmatrix}.$$

Since there exists the common positive matrix  $\mathbf{P}$  which satisfies the stability sufficient condition (3), the closed loop system is asymptotically stable in the large. That is, the backward parking can be accomplished for all initial conditions.

$$\text{Common positive definite matrix : } \mathbf{P} = \begin{bmatrix} 113.9 & -92.61 & 2.540 \\ -92.61 & 110.7 & -3.038 \\ 2.540 & -3.038 & 0.5503 \end{bmatrix}$$

Two initial conditions used for the simulations of the truck-trailer system are given in Table 1.

CASE	$x_1(0)$ [deg]	$x_2(0)$ [deg]	$x_3(0)$ [m]
CASE I	0	0	20
CASE II	-90	135	-10

Table 1: The initial conditions of the truck-trailer system

Fig. 5(a) and (b) show the simulation results for CASE I and CASE II. As can be seen in these Figures, the backing up control for each initial condition is accomplished effectively.

### 5.3 Discrete time fuzzy controller applied to the system with time-delay

In many cases, vision sensor is generally needed to measure the state  $\mathbf{x}(k)$  of the truck-trailer system[17]. The time-delay can be made by the vision sensor in the transferring of image and the image processing. Also, it can be made by the digital hardware in the calculation of the fuzzy algorithm and by the actuator in adjusting the steering angle. Let  $\tau$  be defined as the sum of all this time-delay. In the case of the real system, the ideal fuzzy controller of Eq. (21) can be described as follows due to the time-delay.

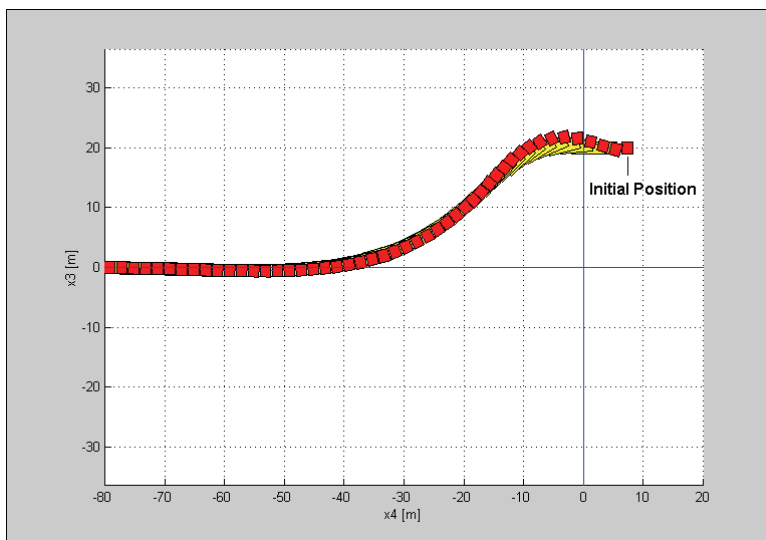

Fig. 5. (a). Simulation result for CASE I

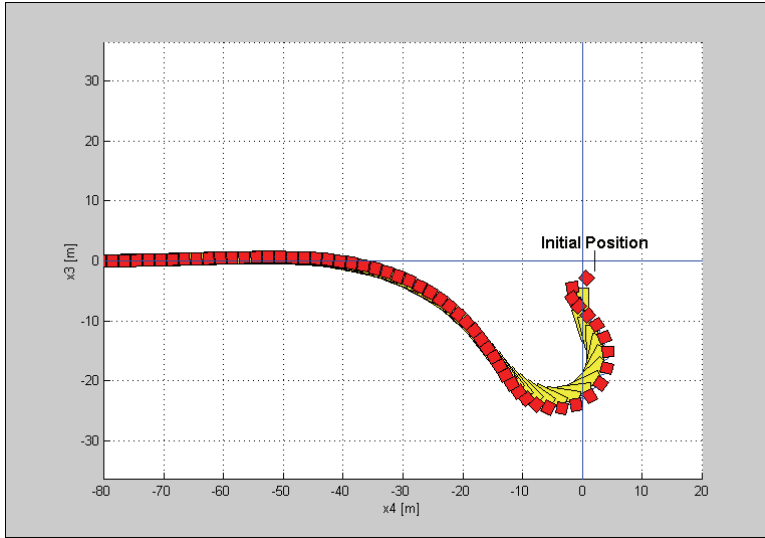

Fig. 5. (b). Simulation result for CASE II

$$\begin{aligned}
 \text{Rule 1: If } x_2(kT) + vT / \{2L\} \cdot x_1(kT) \text{ is } M_1 \\
 \text{THEN } u(kT + \tau) = \mathbf{F}_1^T \mathbf{x}(kT) \\
 \\
 \text{Rule 2: If } x_2(kT) + vT / \{2L\} \cdot x_1(kT) \text{ is } M_2 \\
 \text{THEN } u(kT + \tau) = \mathbf{F}_2^T \mathbf{x}(kT)
 \end{aligned} \tag{23}$$

The simulation is executed in the case that the time-dealy  $\tau$  is a half of the sampling time ( $\tau = 1$  [sec]). Fig. 6 (a) and (b) show that the truck-trailer system is oscillating and the fuzzy controller can not accomplish the backing up control effectively.

**5.4 Proposed digital fuzzy controller applied to the system with time-delay**

In this subsection, we design the DFC considering time-delay. Following the design technique of DFC in section 4, we can construct the DFC for the backing up control problem as follows.

$$\begin{aligned}
 \text{Rule 1: If } x_2(k) + vT / \{2L\} \cdot x_1(k) \text{ is } M_1 \\
 \text{THEN } u(k + 1) = \mathbf{D}_1 u(k) + \mathbf{E}_1 \mathbf{x}(k) \\
 \\
 \text{Rule 2: If } x_2(k) + vT / \{2L\} \cdot x_1(k) \text{ is } M_2 \\
 \text{THEN } u(k + 1) = \mathbf{D}_2 u(k) + \mathbf{E}_2 \mathbf{x}(k)
 \end{aligned} \tag{24}$$

Combining Eq. (20) with Eq. (24), the augmented closed loop system is given as follows.

$$\mathbf{w}(k + 1) = \sum_{i=1}^2 h_i(k) \mathbf{G}_i \mathbf{w}(k) \tag{25}$$

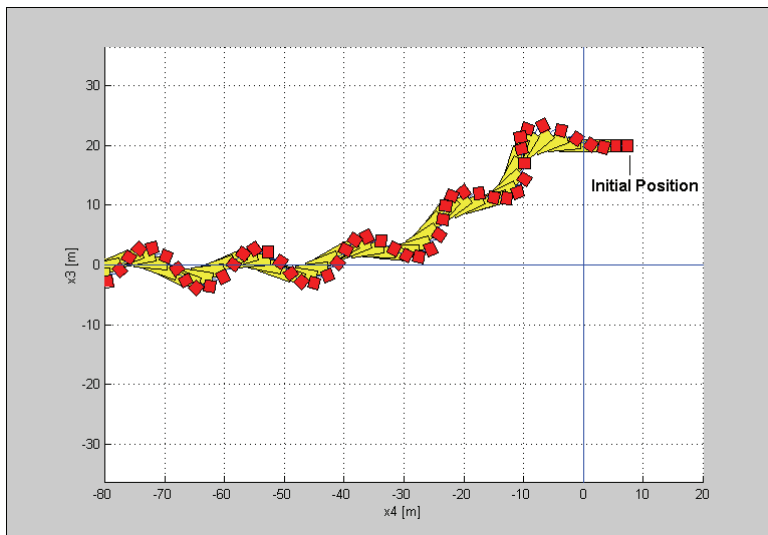

Fig. 6. (a). Simulation result for CASE I ( $\tau = 1$ )

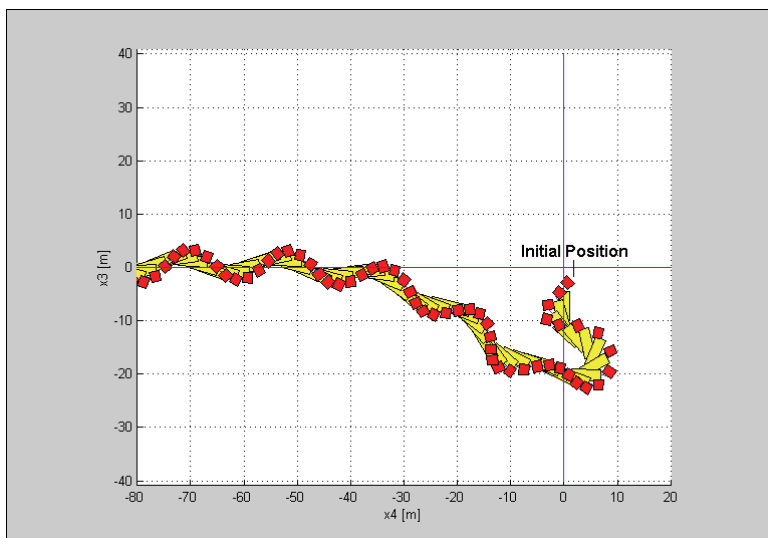

Fig. 6. (b). Simulation result for CASE II ( $\tau = 1$ )

where  $G_1 = \begin{bmatrix} A_1 & B_1 \\ E_1 & D_1 \end{bmatrix}$ ,  $G_2 = \begin{bmatrix} A_2 & B_2 \\ E_2 & D_2 \end{bmatrix}$

To obtain the control gain matrices  $D_1, D_2, E_1, E_2$  guaranteeing the stability of the closed loop system (25), we solve the *LMI feasibility problem equivalent to DFC design problem* as follows.

The problem of finding  $X > 0$  and  $M_1, M_2$  which satisfy the following inequalities:

$$\begin{bmatrix} \mathbf{X} & \{\bar{\mathbf{A}}_i \mathbf{X} - \bar{\mathbf{B}} \mathbf{M}_i\}^T \\ \bar{\mathbf{A}}_i \mathbf{X} - \bar{\mathbf{B}} \mathbf{M}_i & \mathbf{X} \end{bmatrix} > \mathbf{0}$$

where  $\bar{\mathbf{A}}_i = \begin{bmatrix} \mathbf{A}_i & \mathbf{B}_i \\ \mathbf{0} & \mathbf{0} \end{bmatrix}$  and  $\bar{\mathbf{B}} = \begin{bmatrix} \mathbf{0} \\ \mathbf{I} \end{bmatrix}$ ,  $i=1, 2$

The matrices  $\mathbf{X}$  and  $\mathbf{M}_1, \mathbf{M}_2$  in LMI's are determined using a convex optimization technique offered by [18].

$$\mathbf{X} = \begin{bmatrix} 157.0056 & 61.9680 & -1.6565 & 220.727 \\ 61.9680 & 50.4822 & 69.8423 & 53.4329 \\ -1.6565 & 69.8423 & 489.4416 & -2.3866 \\ 220.727 & 53.4329 & -2.3866 & 442.6866 \end{bmatrix},$$

$$\mathbf{M}_1 = [-96.3672 \quad -43.1521 \quad 41.8056 \quad -5.8356],$$

$$\mathbf{M}_2 = [-116.3143 \quad -66.0021 \quad 1.3065 \quad -22.9842]$$

The feedback gains and a common positive definite matrix,  $\mathbf{P}$  are determined by the relationship (18) as follows.

$$\mathbf{P} = \mathbf{X}^{-1} = \begin{bmatrix} 0.0995 & -0.1036 & 0.0149 & -0.0370 \\ -0.1036 & 0.1373 & -0.0198 & 0.0350 \\ 0.0149 & -0.0198 & 0.0049 & -0.0050 \\ -0.0370 & 0.0350 & -0.0050 & 0.0165 \end{bmatrix},$$

$$\bar{\mathbf{F}}_1 = \mathbf{M}_1 \mathbf{X}^{-1} = -[\mathbf{E}_1 \quad \mathbf{D}_1] = [-3.9047 \quad 2.6765 \quad -0.3020 \quad 1.5869],$$

$$\bar{\mathbf{F}}_2 = \mathbf{M}_2 \mathbf{X}^{-1} = -[\mathbf{E}_2 \quad \mathbf{D}_2] = [-3.8624 \quad 2.1564 \quad -0.3102 \quad 1.6123]$$

Therefore, the closed loop system is asymptotically stable in the large and the control gain matrices are given as follows by *PDC design problem equivalent to DFC design problem*.

$$\mathbf{D}_1 = -1.5869, \quad \mathbf{D}_2 = -1.6123,$$

$$\mathbf{E}_1 = [3.9047 \quad -2.6765 \quad 0.3020], \quad \mathbf{E}_2 = [3.8624 \quad -2.1564 \quad 0.3102]$$

Fig. 7 (a) and (b) show the simulation results of the designed DFC. As can be seen in these figures, the backward parking is accomplished successfully for CASE I and CASE II although the considerable time-delay ( $\tau = 1$  [sec]) exists.

## 6. Conclusions

In this chapter, we have developed a DFC framework for a class of systems with time-delay. Because the proposed controller was synchronized with the sampling time delayed with unit

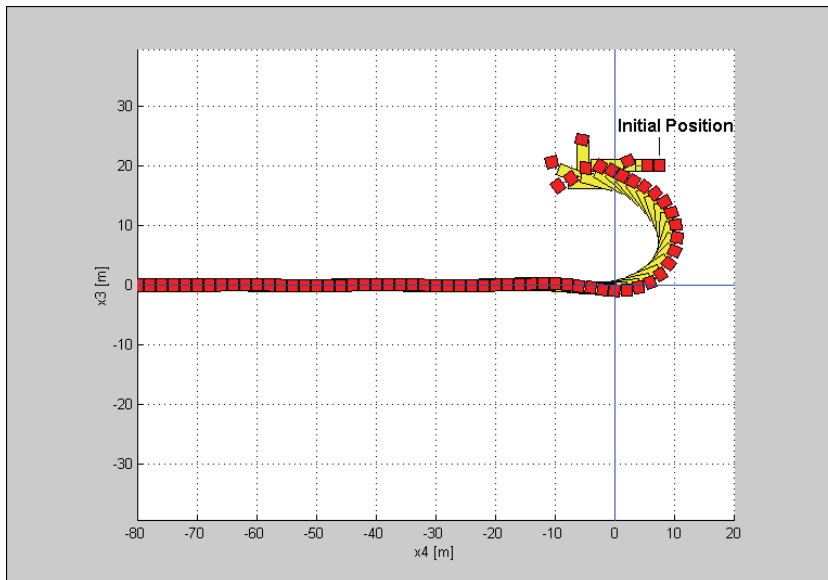

Fig. 7. (a). Simulation result by DFC for CASE I

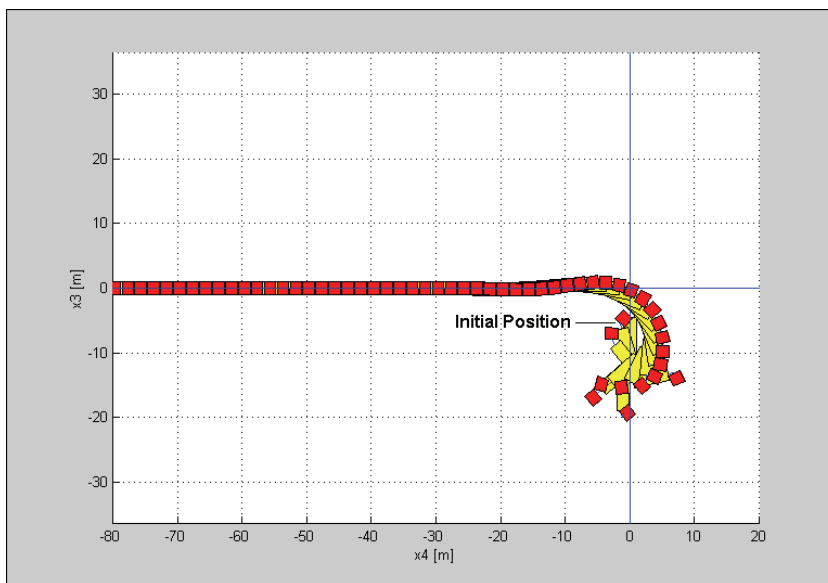

Fig. 7. (b). Simulation result by DFC for CASE II

sampling period and predicted, the analysis and the design problem considering time-delay could be very easy. Convex optimization technique based on LMI has been utilized to solve the problem of finding stable feedback gains and a common Lyapunov function. Therefore the stability of the system was guaranteed in the existence of time-delay and the real-time

control processing could be possible. To show the effectiveness and feasibility of the proposed controller we have developed a digital fuzzy control system for backing up a computer-simulated truck-trailer with time-delay. Through the simulations, we have shown that the proposed DFC could achieve backing up control of a truck-trailer successfully although a considerable time-delay existed.

## 7. References

- [1] Horowitz, I. : 'Some properties of delayed controls', *Int. J. Contr.*, 1983, 38 (5), pp. 977-990
- [2] Leva, A., C. Maffezzoni and R. Scattolini : 'Self-tuning PI-PID regulators for stable systems with varying delay', *Automatica*, 1994, 30 (7), pp. 1171-1183
- [3] Kim, J.H., J.H. Park and S.W. Lee : 'A two-layered fuzzy logic controller for systems with deadzones', IFSA'93 World Congress, July 1993, Seoul, Korea, pp. 826-829
- [4] Jang, M.J. and C.L. Chen : 'Fuzzy successive modelling and control for time-delay systems', *International Journal of Systems Science*, 1996, 27 (12), pp. 1483-1486
- [5] Li, H.X. and S.K. Tso : 'Higher order fuzzy control structure for higher order or time-delay systems', *IEEE Trans. Fuzzy Systems*, 1999, 7 (5), pp. 540-542
- [6] Takagi, T. and M. Sugeno : 'Fuzzy identification of systems and its applications to modeling and control', *IEEE Trans. Systems, Man, and Cybernetics*, 1985, 15 (1), pp. 116-132
- [7] Tanaka K. and M. Sugeno : 'Stability analysis and design of fuzzy control systems', *Fuzzy Sets and Systems*, 1992, 45 (2), pp. 135-156
- [8] Ting, C.S., T.H.S. Li and F.C. Kung : 'An approach to systematic design of fuzzy control system', *Fuzzy Sets and Systems*, 1996, 77, pp. 151-166
- [9] Tanaka, K. and M. Sano : 'A robust stabilization problem of fuzzy control systems and its application to backing up control of a truck-trailer', *IEEE Trans. Fuzzy Systems*, 1994, 2 (2), pp. 119-133
- [10] Wang, H.O., K. Tanaka and M.F. Griffin : 'An approach to fuzzy control of nonlinear systems: Stability and design issues', *IEEE Trans. Fuzzy Systems*, 1996, 4 (1), pp. 14-23
- [11] Tanaka, K., T. Kosaki and H.O. Wang : 'Backing control problem of a mobile robot with multiple trailers: fuzzy modeling and LMI-based design', *IEEE Trans. Fuzzy Systems*, 1998, 28 (3), pp. 329-337
- [12] Kiriakidis, K. : 'Non-linear control system design via fuzzy modelling and LMIs', *Int. J. Control*, 1999, 72 (7/8), pp. 676-685
- [13] Boyd, S., L.E. Ghaoui, E. Feron and V. Balakrishnan : 'Linear matrix inequalities in systems and control theory' (SIAM, Philadelphia, 1994)
- [14] Nesterov, Y. and A. Nemirovsky : 'Interior-point polynomial methods in convex programming' (SIAM, Philadelphia, 1994)
- [15] Kong, S.G. and B. Kosko : 'Adaptive fuzzy systems for backing up a truck-and-trailer', *IEEE Trans. Neural Net.*, 1992, 3, pp. 211-223
- [16] Tokunaga, M. and H. Ichihashi : 'Backer-upper control of a trailer truck by neuro-fuzzy optimal control', 8th Fuzzy System Symp., May 1992, Japan, pp. 49-52
- [17] Tanaka, K. and T. Kosaki : 'Design of a stable fuzzy controller for an articulated vehicle', *IEEE Trans. Systems, Man, and Cybernetics*, 1997, 27 (3), pp. 552-558
- [18] Gahinet, P., A. Nemirovski, A. Laub, and M. Chilali : 'LMI Control Toolbox' (The MathWorks, Inc., Natick, 1995)





## **Fuzzy Systems**

Edited by Ahmad Taher Azar

ISBN 978-953-7619-92-3

Hard cover, 216 pages

**Publisher** InTech

**Published online** 01, February, 2010

**Published in print edition** February, 2010

While several books are available today that address the mathematical and philosophical foundations of fuzzy logic, none, unfortunately, provides the practicing knowledge engineer, system analyst, and project manager with specific, practical information about fuzzy system modeling. Those few books that include applications and case studies concentrate almost exclusively on engineering problems: pendulum balancing, truck backeruppers, cement kilns, antilock braking systems, image pattern recognition, and digital signal processing. Yet the application of fuzzy logic to engineering problems represents only a fraction of its real potential. As a method of encoding and using human knowledge in a form that is very close to the way experts think about difficult, complex problems, fuzzy systems provide the facilities necessary to break through the computational bottlenecks associated with traditional decision support and expert systems. Additionally, fuzzy systems provide a rich and robust method of building systems that include multiple conflicting, cooperating, and collaborating experts (a capability that generally eludes not only symbolic expert system users but analysts who have turned to such related technologies as neural networks and genetic algorithms). Yet the application of fuzzy logic in the areas of decision support, medical systems, database analysis and mining has been largely ignored by both the commercial vendors of decision support products and the knowledge engineers who use them.

### **How to reference**

In order to correctly reference this scholarly work, feel free to copy and paste the following:

Chang-Woo Park (2010). Digital Stabilization of Fuzzy Systems with Time-Delay and Its Application to Backing up Control of a Truck-Trailer, Fuzzy Systems, Ahmad Taher Azar (Ed.), ISBN: 978-953-7619-92-3, InTech, Available from: <http://www.intechopen.com/books/fuzzy-systems/digital-stabilization-of-fuzzy-systems-with-time-delay-and-its-application-to-backing-up-control-of->

**INTECH**  
open science | open minds

### **InTech Europe**

University Campus STeP Ri  
Slavka Krautzeka 83/A  
51000 Rijeka, Croatia  
Phone: +385 (51) 770 447  
Fax: +385 (51) 686 166

### **InTech China**

Unit 405, Office Block, Hotel Equatorial Shanghai  
No.65, Yan An Road (West), Shanghai, 200040, China  
中国上海市延安西路65号上海国际贵都大饭店办公楼405单元  
Phone: +86-21-62489820  
Fax: +86-21-62489821



© 2010 The Author(s). Licensee IntechOpen. This chapter is distributed under the terms of the [Creative Commons Attribution-NonCommercial-ShareAlike-3.0 License](#), which permits use, distribution and reproduction for non-commercial purposes, provided the original is properly cited and derivative works building on this content are distributed under the same license.