

Development of Service Robot System With Multiple Human User Interface

Songmin Jia and Kunikatsu Takase
*University of Electro-Communications, Tokyo
Japan*

1. Introduction

Interactive human user interfaces are indispensability because robot has not enough capability in recognition and judgment in performing a service task at facilities or at home. We have been developing a network distributed Human-Assistance Robotic System in order to improve care cost and the QoL (Quality of Life) of elderly people in the population-aging society. Many elderly persons with some chronic disease give up independent living because of difficulty in moving their body to take something such as operating objects in a refrigerator. Implementation of human-assist robotic system enables elderly or disabled people in need for support and care to live independently in their accustomed home environments as long as they wish. This not only fulfils their desire for independence and autonomy, it also helps to improve the costs for the individual treatment. Many service robotic systems have been developed for the Web (World Wide Web) in recent past, as the Internet is low cost and widely available. Schulz et al. (Schulz et al, 2000) and Maeyama (Maeyama et al., 2000) developed museum tour-guide robotic systems that enable ordinary people at home or some other place to remotely view works of art in a museum by manipulating the vision of the robot using a Web browser. Lung N. et al developed an Internet-based robotic system that allows the user to control a robot arm with five degrees of freedom in performing the tedious household task of sorting laundry (Nagi et al., 2002). Coristine et al. developed PumaPaint Project that is an online robot that allows World Wide Web users to remotely create original artwork. This site had thousands of users who consider it entertaining (Coristine et al., 2004; Stein et al., 2000). Our HARSP (Human-Assistance Robotic System Project) project consists on developing a Human-Assistance Robotic distributed System in order to improve care cost and the QoL of the elderly people in the population-aging society (Jia et al., 2002). The proposed system has the potential to provide elderly persons local services in:

- a) Intelligent reminding: remind elderly persons about important activities such as taking medical, eating meals, visiting the bathroom, or scheduling medical appointments.
- b) Data collection and surveillance: robot can assist the aged or disabled in systematic data collection. Robotic systems may be soon able to inform human caregivers for assistance if they detect that an elderly person has fallen or the other emergency.
- c) Daily services: many elderly persons with some chronic disease give up independent living because of difficulty in moving their body to take something such as operating

Source: Human-Robot Interaction, Book edited by Nilanjan Sarkar,
ISBN 978-3-902613-13-4, pp.522, September 2007, Itech Education and Publishing, Vienna, Austria

objects in refrigerators. A mobile robot integrating with a skilful robot arm could help the aged or disabled overcome these barriers and supply them necessary daily services. They can supply meal support, medical support and delivery support.

- d) Mobility aid: support the aged or disabled for getting up from the bed or a chair, and implement intelligent walking aid.

We developed multi-robot, and implemented several CORBA application servers, which enabled the user to control the system by using Web browser. In the formerly developed system, the iGPS (indoor Global Positioning System) has been developed to localize an omnidirectional mobile robot (Hada et al., 2001). In this paper, a novel method of localization of mobile robot with a camera and RFID (Radio Frequency Identification) technology is proposed as it is inexpensive, flexible and easy to use in the practical environment. The information of obstacles or environment such as size, colour,, world coordinates can be written in ID tags in advance, which helps mobile robot recognize the obstacle or localization easily and quickly compared with the other method. When the working domain of mobile robot is changed or extended, what needs to be done is just putting the new ID (Identification) tags in new environment and registering these ID tags to database. It is also easy to improve dynamic obstacles recognition (such as chair or person) and occlusion problem that are very difficult to solve for the other system, because the communication between ID Reader and ID Tags uses Radio Frequency. A video/audio conference system is also developed to improve the interaction among the users, switch robot manipulating privilege with the help of a centralized user management server, and enable web-user to get a better understanding of what is going on in the local environment. Considering multi-type user of the developed system, we have implemented multi-type HRI that enable different user to control robot systems easily. Implementation of our developed system enables elderly or disabled people in need for support and care to live independently in their accustomed home environments as long as they wish. A mobile robot integrating with a skilful robot arm could help the aged or disabled overcome these barriers and supply them necessary daily services. This not only fulfils their desire for independence and autonomy, it also improves the problem of the high costs for the individual treatment in nursing homes.

The rest of the paper consists of 6 sections. Section 2 presents the structure of the multi-robot system. Section 3 introduces the proposed method of localization of mobile robot. Section 4 details the developed function of the CORBA application servers. Section 5 explains multiple human robot interfaces for the users interacting. The experimental results are given in Section 6. Section 7 concludes the paper.

2. Multi-Robot Systems

Multi-robot cooperation to perform service tasks for supporting the aged or disabled is indispensable in the population-aging society. The mobile platform equipped with a dexterous manipulator is convenient, but it is very difficult to handle the objects (such as operating objects in refrigerators) because of the difficulty to control the position and orientation of the mobile platform and the manipulator mounted on the mobile platform. In our system, we adopted using a robot arm with five degrees of freedoms cooperating with a mobile robot to implement the service tasks. This method makes it easier to operate the objects such as in refrigerators.

2.1 Robot arm and hand

The Mitsubishi Movemaster Super RV-E3J (5 DOF, Figure 1) is fixed on the place where there are many objects collected, and its manipulability range is approximately 1000 mm in height, 830 mm in radius from -160° to 160° . The maximum speed of the robot arm is about 3500mm/sec; its load weight is about 3.5kgf. The robot arm can manipulate the objects with sufficient dexterity to permit delicate and precise actions. Cameras were mounted on the environment around the robot arm in order to recognize the objects. The communication between the robot arm controller and robot arm control server computer is via RS-232C. To manipulate objects with accuracy and safety and prevent the robot from breaking object it handles, force sensors are affixed to the robot fingers. We designed the CPU control system to measure the grasp force and the servo-driving circuit to drive the fingers (Jia, et al., 2001).



Figure 1. Robot arm and robot hand

2.2 Nonholonomic mobile robot

In the formerly developed system, the omnidirectional mobile robot was used to deliver the objects. Because of the specific structure of its wheel arrangement, it is difficult for the omnidirectional mobile robot to pass over bump or enter a room where there is a threshold. Another important point is to lower costs and decrease the number of motors so that the battery can supply enough electricity for mobile robot to run for a longer time. In our new system, we developed a nonholonomic mobile robot that was remodeled from a commercially available manual cart. The size of the mobile robot is about 700mm x 450mm x 700mm. The structure of the front wheels was changed with a lever balance structure to make mobile robot move smoothly, and the motors were fixed to the two front wheels. It has low cost and is easy to pass over bump or gap between floor and rooms. We selected Maxon EC motor and a digital server amplifier 4-Q-EC 50/5 which can be controlled via RS-232C. For the controller of mobile robot, a PC104 CPU module (PCM-3350 Geode GX1-300 based) is used, on which RT-Linux is running. For communication between a mobile robot and mobile robot control server running on the host computer, the Wireless LAN (PCMCIA-WLI-L111) is used. Figure 2 (a) shows the developed mobile robot. And Figure 2(b) shows the structure of the mobile robot platform.

2.3 RFID system

KENWOOD series was used in the developed system. Tag reader S1500/00 communicates with tags via 2.45GHz radio wave. Since there is a communication area between ID tag and tag reader (the communication between mobile robot controller and tag reader is via RS 232C), so if ID tag comes into the communication area while mobile robot moves to the place close to the ID tags, the ID tag can be detected and the information written in it can simultaneously be read by tag reader mounted on the mobile robot. When the working domain of mobile robot is changed or extended, what needs to be done is just putting the new ID tags in new environment and registering these ID tags to database. It is also helpful to improve dynamic obstacles recognition (such as chair or person).

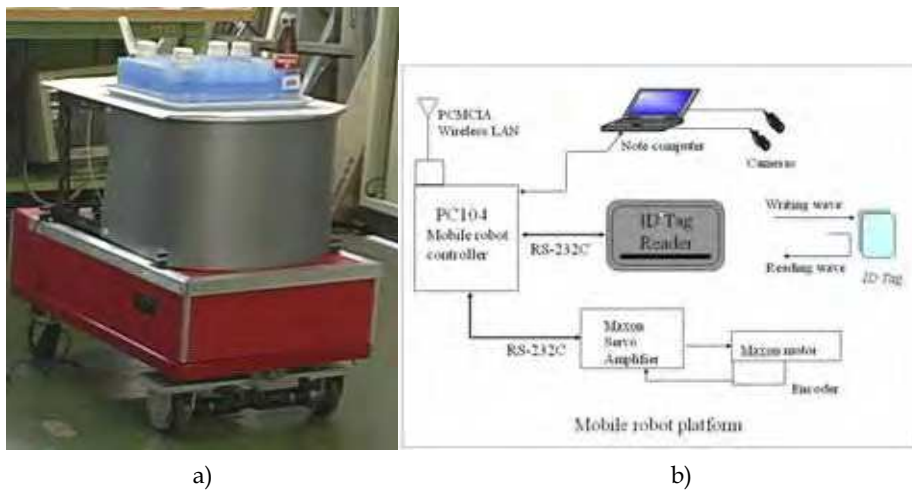

Figure 2. Mobile robot; (a) is the developed mobile; (b) is the structure of mobile robot platform

3. Localization of Mobile Robot

Localization is the most important fundament for a mobile robot to perform a service task in office, at facility or at home. In many previous research works, various methods for localization using many kinds of sensors for mobile robot purpose have been proposed. In this paper, we developed a novel method of localization with a camera and RFID technology to determine the position and orientation of mobile robot as it is inexpensive, flexible and easy to use in the practical environment (Lin et al, 2004). For static obstacles, the user registers ID tags to database beforehand, each ID tag includes the information of the object such as table, bookshelf or feature position like corners, passage crossing or entrance of door. For dynamic or uncertain obstacles with a new ID, the system can detect a new ID tag and read out the information of this ID dynamically, thus decreases the computation of obstacle recognition. It is also helpful to improve dynamic obstacles recognition (such as chair or person) and occlusion problem that are very difficult to solve. This is because the communication between ID reader and ID tags uses Radio Frequency. Figure 3 illustrates the principle of localization of mobile robot.

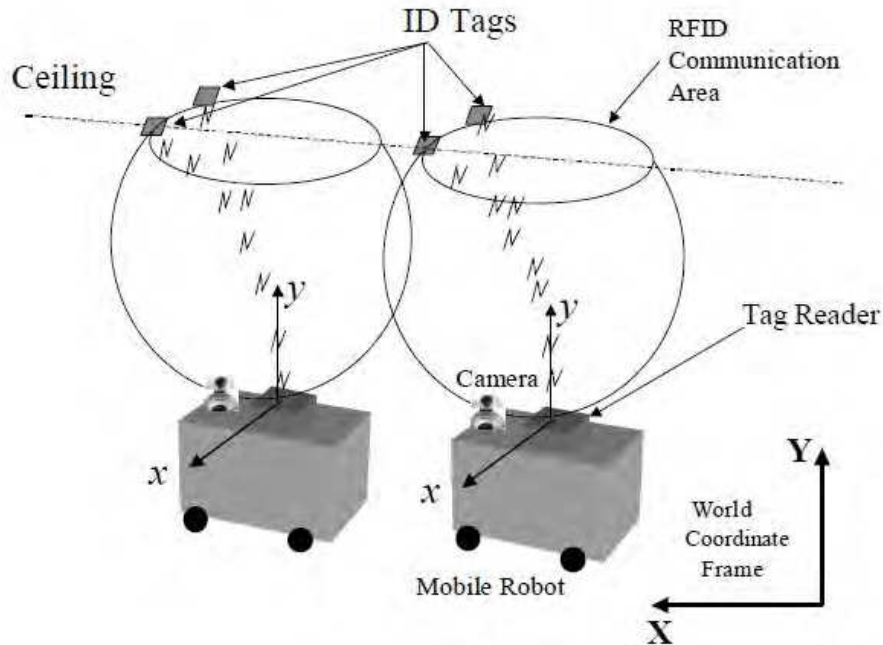

Figure. 3. The principle of localization of mobile robot with RFID and camera

The tag reader and a camera are mounted on mobile robot platform, and ID tags are put on the obstacle or environment of the mobile robot moving. Since there is a communication area between ID tag and tag Reader (the communication between mobile robot controller and tag reader is via RS-232C), so if ID tag comes into the communication area while mobile robot moves to the place close to the ID tags, the ID tag can be detected by tag reader mounted on the mobile robot and the information written in ID tags in advance can be read out at the same time. When the ID tag was detected by reader, the system can judge first that ID tags are obstacle tag or localization tag. As every localization ID tag has a unique ID, so every localization ID tag can indicate an absolute position in the environment. After getting the absolute position of a localization ID tags, we can measure the relative position and orientation of mobile robot to this ID tag using a camera in order to get the world coordinates of the mobile robot.

The camera with 640 × 480 resolution and 30fps frame rate was mounted on the mobile robot to be used in the system to recognize the ID tags then get the relative position of mobile robot. In order to improve the speed of imaging processing, a window function for fast extraction of ID tags has been used. The weighted sum of each window can be calculated by equation (1), (2).

$$Z[m, n] = \sum_{x=0}^k \sum_{y=0}^l G[i, j] W[x, y] \quad (1)$$

$$G[i,j] = \sqrt{(f[i,j+1] - f[i,j])^2 + (f[i,j] - f[i+1,j])^2} \quad (2)$$

Here, $G[i,j]$ is gradient function of point $[i,j]$, $f[i,j]$ is the gray level of a point $[i,j]$ in the image. $K \times l$ are window size, it depends on the size of the ID tags and the background of the experiment environment. $W[x,y]$ is a $k \times l$ window array and every elements is 1. If the weighted sum $Z[m,n]$ is smaller than a given threshold (determined by experiments), the dilation processing technique for this window will be done in order to judge that the detected area is ID tag or not. As the image size of camera is 640×480 , the size of window is 8×8 , so there are only 80×60 elements in $Z[m, n]$. The selection of window size 8×8 was justified by the results of experiments. Selecting a bigger window size can speed up image processing speed, but it lowers the precision of recognition. Conversely, selecting a smaller window size can get better recognition of ID tag, but it increases the computation of image processing.

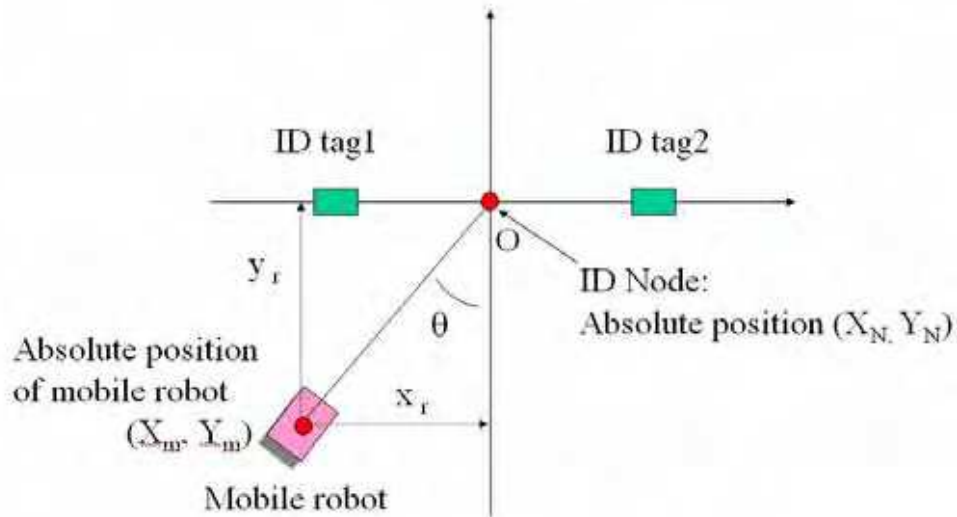

Figure 4. The calculation of the world coordinates of a mobile robot

Two ID tags as a node are affixed on the feature positions of ceiling such as corners, passage crossings, or entrance of door. The middle point of two ID tags is used as the absolute position of ID node in environment. Using camera system to recognize the ID tags can get the relative position of mobile robot with the ID tags. Then the absolute position of mobile robot in world coordinate frame can be calculated by the following equations (equation (3), (4), (5)). Figure 4 illustrates how we can calculate the world coordinates of mobile robot using the proposed method.

$$X_m = X_N - x_r \quad (3)$$

$$Y_m = Y_N - y_r \quad (4)$$

$$\theta = \arctan \frac{Y_L - Y_R}{X_L - X_R} = \arctan \frac{y_L - y_R}{x_L - x_R} \quad (5)$$

Here, X_N, Y_N are the absolute position of a ID node. When the ID reader detects the ID tag1 and ID tag2, X_N and Y_N can be calculated according to the absolute coordinates of two tags registered beforehand.

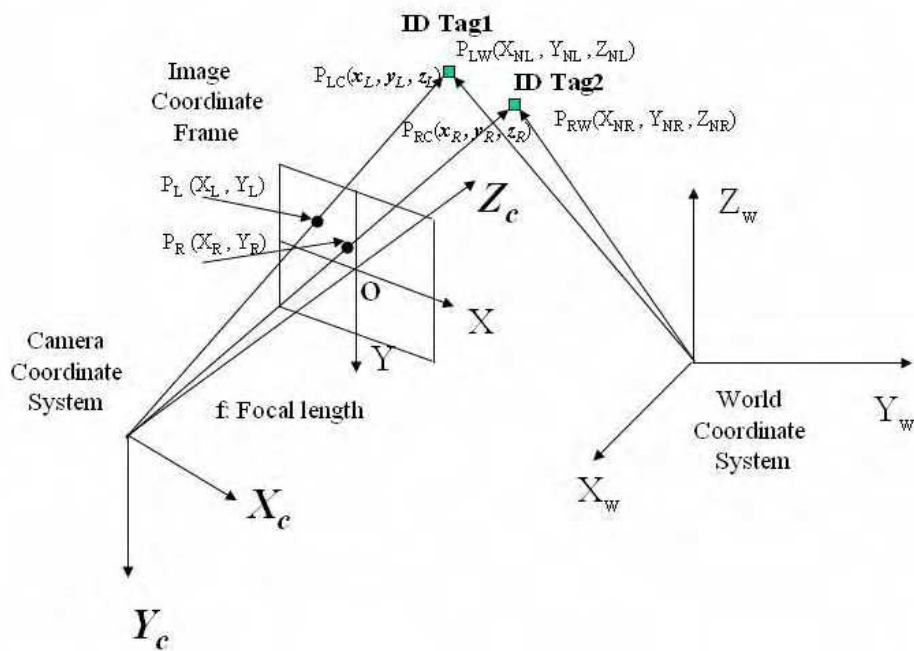

Figure 5. World coordinate system, camera coordinate system and image coordinate frame

Figure 5 illustrates the relationship among World Coordinate System, Camera Coordinates System and Image Coordinates Frame used in our system. The origin of World Coordinate System was set at the corner of environment the mobile robot moves in. The origin of Camera Coordinates System was set at the focus of CCD camera mounted on the mobile robot. $P_{LW}(X_{NL}, Y_{NL}, Z_{NL})$ and $P_{RW}(X_{NR}, Y_{NR}, Z_{NR})$ are the coordinates of two ID tags in World Coordinate System. $P_{LC}(x_L, y_L, z_L)$ and $P_{RC}(x_R, y_R, z_R)$ are the coordinates of two ID tags in Camera Coordinate System. $P_L(X_L, Y_L)$ and $P_R(X_R, Y_R)$ are the projected coordinates of two ID tags in Image Coordinates Frame. According to coordinate transformation, we can calculate x_L, y_L, x_R, y_R and X_L, Y_L, X_R, Y_R . θ is the orientation angle of the mobile robot in the world coordinate frame. x_r, y_r are the position of mobile robot relative to the node, which can be got by recognition with camera. Using these variables, the coordinates of camera (the coordinates of mobile robot X_m, Y_m in World Coordinate System can be calculated by equation (equation (6)).

$$\begin{pmatrix} \cos \theta & -\sin \theta \\ \sin \theta & \cos \theta \end{pmatrix} \begin{pmatrix} x \\ y \end{pmatrix} + \begin{pmatrix} X_m \\ Y_m \end{pmatrix} = \begin{pmatrix} 0 \\ 0 \end{pmatrix} \quad (6)$$

Here, x and y are the coordinates of the middle point of two ID tags in Camera Coordinate Frame with the coordinates of X , Y in Image Coordinate Frame. X_m and Y_m are the coordinates of camera (the coordinates of mobile robot X_m, Y_m) in World Coordinate System.

As we know, each ID tag has an unique ID, so each ID node can indicate an absolute position in the environment. All the "node" makeup a topologic map of the indoor environment in which the mobile robot moves. For example, if mobile robot moves from START point A to GOAL point F, the moving path can be described with node tree shown in Figure 6. The system searched the shortest path between the START and GOAL node (for example, the shortest path between A and F is $A \rightarrow B \rightarrow C \rightarrow D \rightarrow F$) by tracing the branches between them.

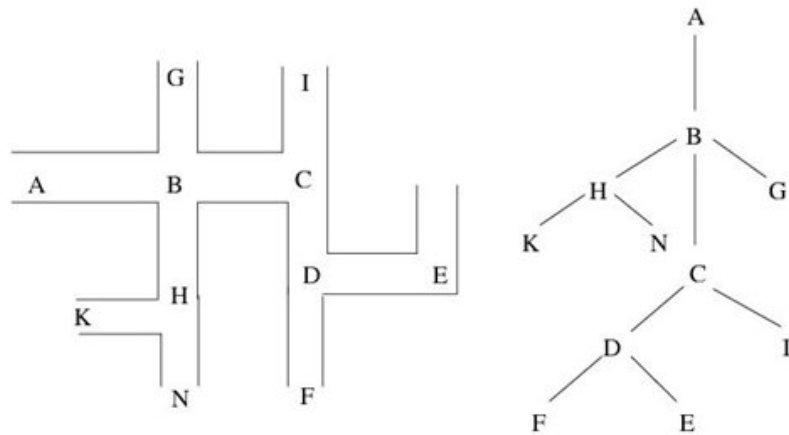

Figure 6. Moving path and its description with node

In order to navigator a mobile robot in an indoor environment, how to build a map is a big problem. In our system, the topological map for mobile robot was used. For building a topological map, the connectivity of ID nodes and the relative direction angles between every two adjacent ID nodes information are necessary. How to represent a node is very important. We represent ID node with a code. A code indicates the location information of this node and its connectivity relationship with surrounding nodes, such as which building, which floor, which room. Now, we represent it with six bit decimal number. For example, a node with 000000 means it is an original node at the first floor. A node with 012221, we can know that it is a sixth level node and the upper level node of it is 012220. Figure 7 depicts the connectivity information from this node to the original node, and node level information.

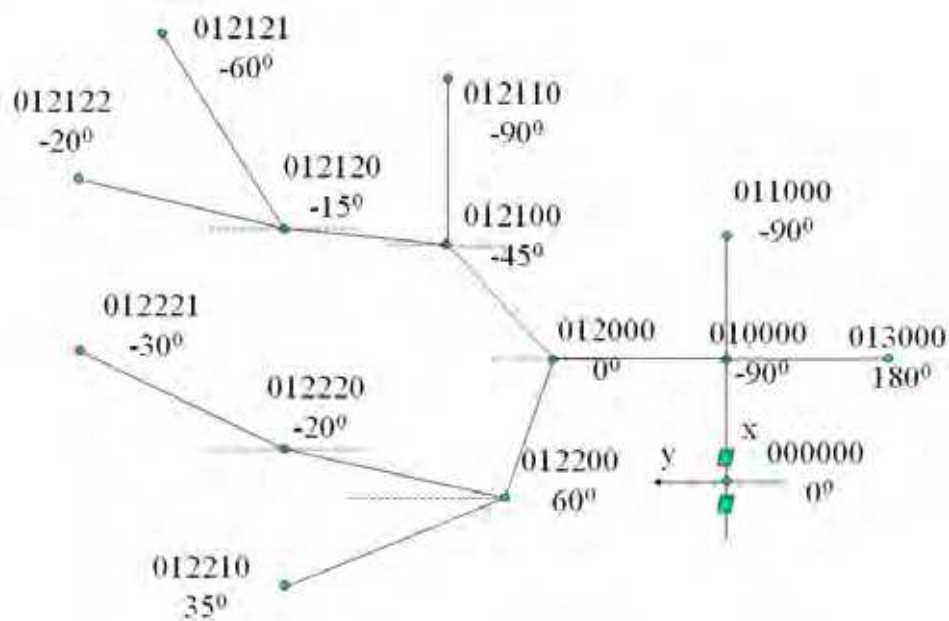

Figure 7. An example of topologic map of the proposed method

4. Application Servers

In our aging society, it would seem particularly important to integrate various kinds of network distributed software and robotic systems for complicated applications aiding the elderly population. Distributed computing technologies that can implement network distributed software sharing and improve the cost of writing and maintaining software is in high demand. The various different distributed computing technologies, termed middleware, include RMI (Remote Method Invocation), DCOM (Distributed Component Object Model), MOM (Messages Oriented Middleware), and CORBA (Common Object Request Broker Architecture). Sun's Java RMI (Java Remote Method Invocation) is a Java-specific RPC middleware that provides a simple and direct model for distributed computation with Java objects. However, its simplicity is enabled by restricting all communication to Java objects only. DCOM is Microsoft's architecture for distributed component-based communication and is based on COM, which is both a specification and implementation developed by Microsoft Corporation. MOM (Message-oriented middleware) provides process-to-process data exchange, enabling the creation of distributed applications. It is analogous to e-mail in the sense that it is asynchronous, requiring the recipients of messages to interpret their meaning and to take appropriate action. MOM is not an industry standard. In contrast to all of these, CORBA (Condie, 1999; Object Management Group; Object Oriented Concepts) focuses on the use of distributed objects to provide for systems integration. CORBA uses GIOPs (General Inter-ORB Protocols), ESIOPs

(Environment Specific Inter-ORB Protocols) and IIOP (Internet Inter-ORB Protocols) to implement a truly heterogeneous distributed system, and makes application and system integration easier. It encourages the writing of open applications, ones that can be used as components of larger systems. Each application is made up of components; integration is supported by allowing other applications to communicate directly with these components. This facilitates network-distributed software sharing and improves the cost of writing and maintaining software. We selected CORBA as communication platform to develop a network-distributed human-assistance robotic system. We implemented User Management Server, Robot Arm Control Server, Mobile Robot Control Server, Real-Time Mobile Robot Positioning Server, and Feedback Image Server, which are independent components and can be distributed on the Internet and executed in parallel. It is possible for the developed system to reduce the number of some used servers, to regroup some of them according to the proposed tasks, and to integrate easily with the other technologies into new comprehensive application systems. The other components of the system can work normally even if there are problems with some of them.

4.1 User Management Server

It implements the management of users' manipulating privilege and the robotic systems manipulating connections between user (caregivers, the aged or disabled), robotic systems and the other CORBA application servers with the help of Authentication/Authorization.

4.2 Service management server

It manages the services that the developed system provides. The caregivers could register new local service tasks and update the information of database. It provides the information about the rationality of service tasks which the user requests. If the user requests a unreasonable task that the system can not provide, the error message will be presented to the user. Additionally, it can autonomously update the database of objects after the robot arm captures the objects.

4.3 Robot Arm Control Server

The task-level robot arm control server allows the remote user to control the remote robot arm at a task level. It receives the task-level requests from the client, performs various kinds of processing and returns the feedback results. When the remote user pushes the command "Juice, Please", the manipulator automatically handles the juice and places it on the tray mounted on the mobile platform. For one method of the task-level robot arm control server, it includes an information part, a task planning part, an implementation part and a communication part (Jia and Takase, 2001). The information part consists of a vision part and a force measure part. It is the source of information for the system. The task planning part receives the information from the information part, recognizes the location and orientation of the tableware scattered on the table, transforms these coordinates to the manipulator's coordinate system, and generates task plan to achieve the goal. Task plan mainly contains how to control the manipulator to achieve the place where the objects to be handle is, and how to grasp it by robot hand. It was implemented autonomously by programming according to the vision and force information (Jia and Takase, 2001). The implementation part executes motion scheduling generated by the task planning part, and it implements the task according to the commands coming from the server computer. The

communication between the server computer, the robot's arm and the robot hand's controller is via RS-232C Links. The details of robot task control algorithm were described in (Jia and Takase, 2001).

4.4 Mobile Robot Control Server

It receives the reasonable requests from the system, and then plans and derives the most appropriate path for the mobile robot to move in order to realize the task what the user issued. It works as:

- a) The mobile robot control server receives control commands from the users.
- b) ORB intercepts commands and transfers the requests to the mobile robot control server.
- c) The mobile robot control server plans and derives a collision-free path that is the shortest distance between the START and GOAL specified by the user.
- d) The mobile robot control server programs the mobile robot to move across wireless TCP/IP Ethernet link. According to the results of experiments, the wireless communication between a mobile robot and mobile robot control server running on the host computer is robust and reliable.
- e) ORB returns the feedback results to the users.

4.5 Real-Time Mobile Robot Positioning Server

It provides the real-time position and orientation of the mobile robot with respect to the world coordinate system, so that the user could get a better understanding of what the mobile robot is carrying out. In our research, we developed the method of positioning mobile robot using RFID and camera.

4.6 Feedback Image Server

The live image feedback server provides various kinds of live feedback images and control modals for Web users. It receives requests from the user, obtains images from cameras mounted in the environment, and compresses the image into JPEG format. Then, ORB returns the new image with the latest information to the client. The user can see live feedback images of the mobile robot moving, the cooperating with the robot arm, and the state of the rooms of the aged or disabled. The user can also select different control modals to obtain "auto" or "step" live feedback images.

5. Multiple HRI (Human-Robot Interface)

Considering multi-type user of the developed system, we have implemented multi-type user interfaces that enable different user to control robot systems easily. Robot systems should be able to interact with local user in a natural way and to allow remote users (caregivers, relatives) to understand the environment where the robot systems are working clearly and easily. For a remote user, we developed Web-based user interface. Video stream, a typical way of providing the information of visualizations for the robotic system working, the environment of robot system and the state of the age and disabled, was also provided in order to enable the remote user to get a better understanding of situation. Due to high bandwidth requirements of video stream and necessity to extend the visualizing range, we also developed image feedback server that provides feedback images getting by cameras mounted in the environment according to the users' options.

5.1 Video/Audio Conference System

It is necessary to receive and transmit media streams in real time to improve interaction in network distributed human-assistance robotic system. Additionally, robot manipulation rights should be appropriately allocated by carefully negotiating among the users (caregivers, local users). In order to meet these special requirements of human-assistance robotic system, a private video/audio conference system was proposed (Hou et al., 2002). Multicast is a clever technique to reduce network bandwidth demand when there are many receivers who want to view or listen to the same source. Therefore, Mbone is the best choice for video/audio conference systems. Since RTP provides unreliable end-to-end network delivery services for the real-time data transmission, it is usually adopted over UDP for media streams even if it is network and transport-protocol independent. This is also because the overhead of guaranteeing reliable data transfer slows the overall transmission rate. The architecture of the proposed video/audio conference system is shown in Figure 8. Media Control (MC) and Media Processor (MP) form the video user client site and manage the video sessions via session manager. (Media Control Centre) MCC resembles a multipoint controller H.323 entity on the network, and provides for the control of three or more terminals participating in a multipoint conference. MCC also provides for capability negotiation with all MC in remote video users site, and controls video resources, such as multicast addresses. MC and MP, which are connected with one another via JMF (Java™ Media Framework) session manager API, work more like another H.323 entity of multipoint processor. They provide for processing, mixing, switching of video/audio streams in a network multipoint conference system. CORBA IIOP is employed as message communication platform between MCC and MC.

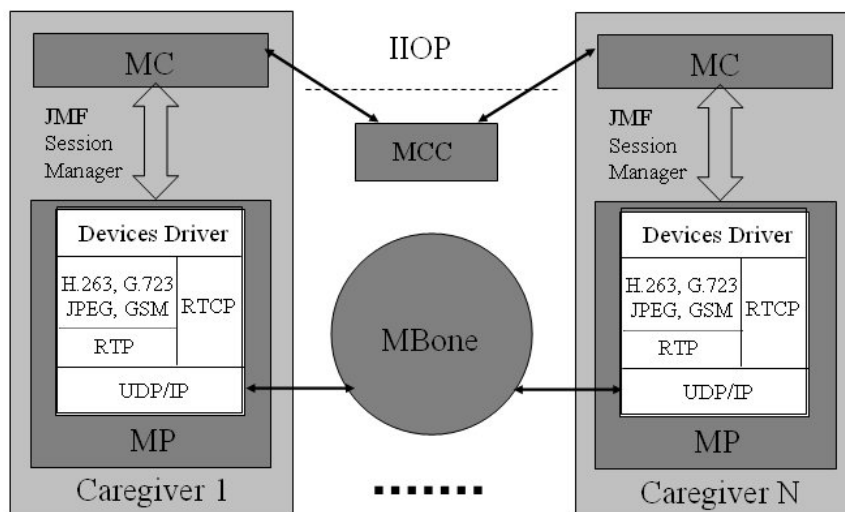

Figure 8. The architecture of the proposed video/audio conference system

5.2 Chat Room Panel

The chat client user interface was developed for changing the manipulating right of robot system. The chat client software is programmed using Java and embedded in the web page as Java applet. Users can login in the chat room, exchange information and transfer robot operating token via this applet. This applet also illustrates the current users who has the manipulating right to operate the multi-robotic system and the log of users operating the robotic system.. After getting the robots manipulating right through the chat room, the other human caregivers can use robotic systems control user interface to control the remote robotic systems to provide services or support for the aged or disabled. In this system, MySQL is used with JDBC. The SQL database MySQL (Yarger et al. 1999) is a popular open source database server in the world. MySQL can be employed to handle large database. The SQL database stores static data (e.g., registry information for users), and dynamic data (e.g., system running states)

5.3 Robot Arm Control and Feedback Image Control Pane

The robot arm control and feedback image control panel including the task-level robot arm control command part, the options and display for different kinds of live feedback images, and control modes (Jia et al., 2002). The task-level robot arm control commands allows the user to submit a task-level request to the system. It consists of meal service commands, drug service commands, and common service commands such as providing a book. Once one task-level is submitted, the other task-level button will be invalid until this task is finished for safety. And the robot arm will recognize and manipulate the objects autonomously. Many options for different kinds of live feedback images have been provided such as the state of the mobile robot cooperating with the manipulator, the rooms of the disabled or aged. In addition, "auto" and "step" control modals of the live image feedback are provided to allow user to see the continuous live feedback images or the "step" image feedback which refreshes the image once after button is pushed.

5.4 Mobile Robot Control Panel

The geometric 2D map is built as a model of the environment of the mobile robotic system's working domain when the user links to this homepage. Its geometric primitives can also be adjusted to add a new obstacle if the environment of the robot system has been changed. The positions where the mobile robot is easy to cooperate with the robot arm, and the mobile robot is easy to pass the objects to the disabled or aged are displayed as marks. The remote user can specify the most appropriate route for the mobile robot to move and directly control the mobile robot to move or rotate in order to cooperate with the manipulator easily if it is necessary. In order to know the state of robotic systems working, the real trajectory of the mobile robot moving was also shown on the user interface. Also, the user can select the live feedback image of the mobile robot, then the user can monitor the state of the mobile robot, the area around it and its pose in real environment.

5.5 Voice User Interface

Natural spoken method is the friendliest way of communication with robot for local user, and it is easy way for the aged or disabled to control robot. We used a commercially available speech system to develop the voice-enabled interface by Visual C++. The task of

speech recognition adapted the syntax of a particular type of BNF (Backus-Naur Form) grammar, is called Speech Recognition Control Language (abbreviated SRCL). A SRCL grammar is defined by enumerating the valid words and phrases. Grammars constructed using SRCL offer an organized view of the words and phrases that are part of the speech grammar, since we define a notation for identifying common phrases, optional phrases and repeated phrases. To improve the recognition rate, we defined 30 SRCL grammars that are relevant to the service tasks the robot systems can provide. The average recognition rate of the developed system is approximately 90% (Wang et al., 2003).

5.6 Touch Panel User Interface

The touch panel user interface has also been developed to make up for the "breakdown" of the speech recognition system, and is helpful to the user who is not convenient to speak to control a robot. When the speech recognition system can not recognize the command the user issued, the system can give user the selection of inputting their request by voice again or using touch interface.

6. Experiments

6.1 Experiments of Localization of mobile robot using RFID and camera

First, we have done the experiments of localization of mobile robot with only RFID technology and compared the results with using odometer which is most widely used. According to the relationship of t_1 (the time tag1 was detected), t_2 (the time tag2 was detected), t_3 (the time tag1 can not be detected), t_4 (the time tag2 can not be detected), we can localize the mobile robot. The experiment is that the mobile robot moves forward about 2.5m from the START position ($x=0, y=0, \Theta=0$) and back. After repeating a number times, in the case of using only odometer the mobile robot's returned positions are far and far from the START position, because odometer has the disadvantage of the slippage problem and inaccuracies of kinematics models with the consequent errors growing with time. The error results of repeating 5 times and 10 time are $\Delta x=38.5\text{cm}$, $\Delta y=-18\text{cm}$, $\Delta \Theta=-13.0^\circ$ and $\Delta x=88.5\text{cm}$, $\Delta y=35.5\text{cm}$, $\Delta \Theta=37.0^\circ$. Using RFID localization system, we can get the feedback information about the position and orientation of mobile robot by RFID, then can adjust the mobile robot to return the hopeful position. The same experiments have been done and the error results of repeating 5 times and 10 time are $\Delta x=11.5\text{cm}$, $\Delta y=-8.5\text{cm}$, $\Delta \Theta=5.5^\circ$ and $\Delta x=5.0\text{cm}$, $\Delta y=-13.5\text{cm}$, $\Delta \Theta=7.5^\circ$. Although these results are better than that of odometer only, we only got the 10cm and 7.5° resolution to the instability of RFID system and it is not enough to navigate a mobile robot to perform a service task in indoor environment. For improvement of the precision of localization of mobile robot, we mounted a camera on the mobile robot platform, integrating the information of RFID, camera and odometer to determine the position and orientation of mobile robot. The maximum error is about $\Delta x=1.9\text{cm}$, $\Delta y=2.5\text{cm}$ and $\Delta \Theta=2.5^\circ$. This result verified that the accuracy of the developed localization system is enough for navigation of mobile robot.

6.2 Video Stream Feedback Experiments

In order to enable remote caregivers to get a better understanding of the local environment, we also provide the live video feedback. The maximum video resolution of the video camera selected is 640 x 480, and its maximum video frame rate is 30 fps (frames per second).

JMF2.1.1 is employed to implement a video/audio transmission. H.263 and JPEG over RTP are implemented for video presentation, and audio encoding select GSM and G.723 over RTP. The performance test of the developed real-time video stream has been done to get live video feedback to monitor the state of the aged or disabled in a campus network. The video server is run on Windows 2000 Professional (Pentium IV, CPU 1.9GHz), and the video client is run on Windows XP (IV, CPU 2.4GHz). The average frame rate is about 19.5fps. The experiments that users transfer robot control token via video/audio conference system have also been done. After entering the multipoint conference, users (e.g., doctor, caregivers) can select media for presentation by double clicking the users names in the middle right of the chat client panel. After a discussion, the robot manipulating token will transfer to an appropriate user. The experiment was successfully done in a campus network. Many options for different kinds of live feedback images have also been provided such as the state of the mobile robot cooperating with the manipulator, the rooms of the disabled or aged. In addition, "auto" and "step" control modals of the live image feedback are provided to allow user to see the continuous live feedback images or the "step" image feedback which refreshes the image once after button is pushed.

6.3 Experiments of User operating the Multi-functional Robot System with HRI

Using CORBA as a communication architecture, we developed a network-distributed multi-functional robotic system to assist the aged and those with impaired mobility, which is very important in the aging society to improve the problem of shortage of persons capable of working and to avoid the high costs for the individual treatment in nursing homes that might otherwise be necessary. We developed a multi-robot, implemented key technologies, and developed CORBA application servers which can be distributed on the Internet and executed in parallel. We also proposed a novel method of localization of mobile robot using RFID system with a camera as it is flexible and easy to use. Considering multi-type user of the system, we have implemented various kinds of user interface that enable different user to control robot system easily. For a remote user, we developed Web-based user interface. Video stream, a typical way of providing the information of visualizations for the local environment was also provided. By remotely controlling a mobile robot to cooperate with a robot arm, the developed system realized successfully some basic services (such as bringing a bottle of water to the aged or disabled) to support the aged and disabled. Figure 9 (a), (b), (c) illustrate some on-line images that the remote Web user is accessing the developed system by using Web use interface.

For a local user (the aged or disabled), they can use natural spoken to control robot systems to realize the local services. If the speech recognition system breaks down, the system can give user the selection of inputting the command again by voice or using touch interface. Touch panel user interface is also helpful to the user who is not convenient to speak to control a robot. Figure 9 (d), (e), (f), (g), (h), (i) illustrates some images that the local user is interacting with mobile robot by speech to instruct the mobile robot to realize a local service task. According to the results of experiments, we know the developed system can provide some daily service to aid the aged or disabled.

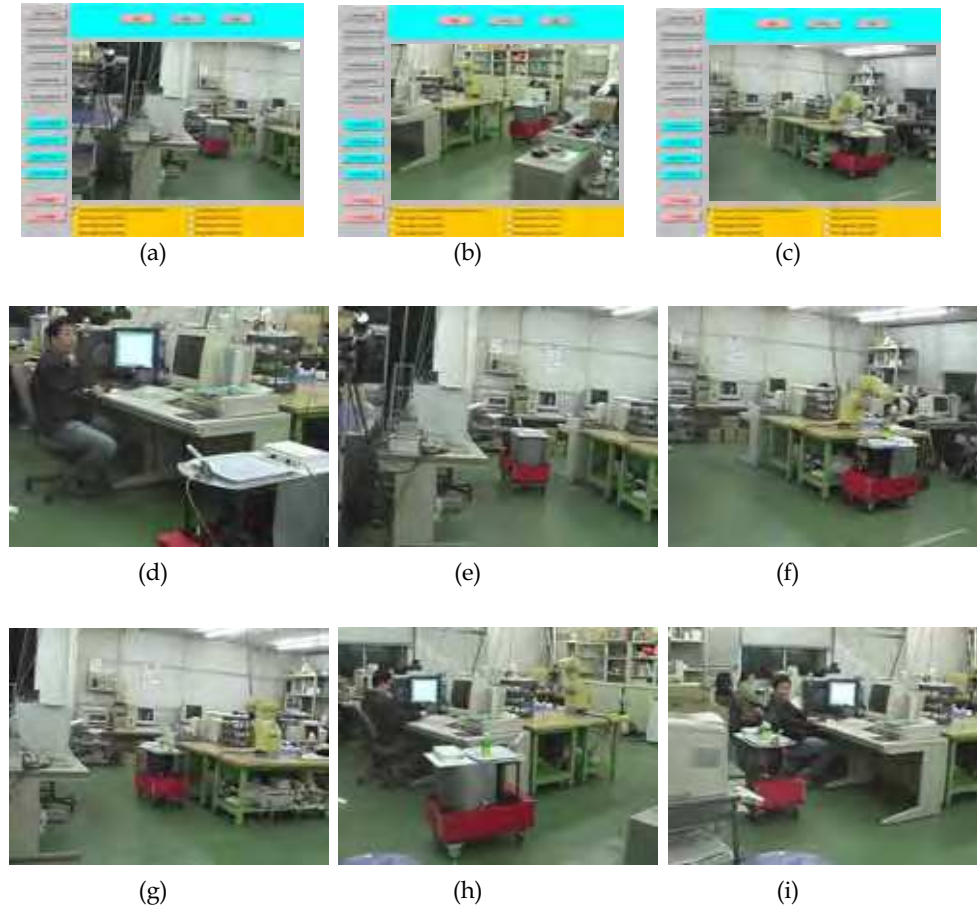

Figure 9. (a), (b), (c) On-line images a remote user interacting with the robotic systems. (d), (e), (f), (g), (h) and (i) are on-line images a local user interacting with mobile robot by speech to instruct the mobile robot to realize a local service task

7. Conclusion

We have been developing a network distributed multi-functional robotic system in order to improve care cost and the QoL of the elderly people. We proposed a novel method of localization of mobile robot using RFID system with a camera as it is flexible and easy to use. Because the information of obstacle or environment can be written in ID tags, the proposed method enables the localization easily and quickly compared with the other method. A video/audio conference system was also developed to improve the interaction among the users and enable web-user to get a better understanding of what is going on in the local environment. Considering multi-type user of the developed system, we have implemented various kinds of user interfaces that enable different users to control robot

system easily. Local user can operate the robot systems by natural speech and touch panel to control a mobile robot cooperating with a skilful robot arm to replace person to operate the objects in refrigerator that is difficult for the aged or disabled, and to supply them necessary daily services. This not only fulfils their desire for independence and autonomy, it also helps to avoid the high costs for the individual treatment in nursing homes that might otherwise be necessary. Caregivers or remote user can support the local user and monitor the state of the aged or disabled and the robotic systems working by video system. Some experimental results verified the effectiveness of the developed system. For future work, improving intelligent and simplifying operation to system, adding services are the main topics.

8. References

- Condie, S. (1999). Distributed computing, tomorrow's panacea-an introduction to current technology, *BT Technol J*, Vol. 17, No. 2, pp. 13-23.
- Coristine, M., Stein, M. R. (2004), Design of a New PumaPaint Interface and Its Use in One Year of Operation, *Proc. of IEEE Int. Conference on Robotics and Automation*, (ICRA'2004), New Orleans, LA., April, pp. 511-516.
- Hada, Y. and Takase, K. (2001), Multiple Mobile Robots Navigation Using Indoor Global Positioning System (iGPS), *Proceedings of 2001 IEEE/RSJ Conference on Intelligent Robots and Systems*, pp. 1005-1010.
- Chunhai Hou, Songmin Jia, Gang Ye and Kunikatsu Takase, (2002), Manipulation Switching Management for Robots in Internet Telecare Systems', *2002 IEEE International Conference on Industry Technology (ICIT'2002)*, December 11-14, 2002, Thailand pp.886-891, 2002.
- Java remote method invocation: <http://java.sun.com/products/jdk/rmi/index.html>.
- JavaTM Media Framework API Guide. Sun Microsystems, Inc., California, USA, 1999.
- Jia, S. and Takase, K. (2001), An Internet Robotic System Based Common Object Request Broker Architecture, *Proc. of IEEE Int. Conference on Robotics and Automation*, (ICRA'2001), Seoul, Korea, pp. 1915-1920.
- Jia, S. and Takase K. (2001), A CORBA-Based Internet Robotic System, *The International Journal of Advanced Robotics*, ISSN 0169-1864, Vol. 15, No. 6, pp. 663-673.
- Jia S., Hada Y., and Takase K. (2003), Telecare Robotic System for Support Elderly and Disabled People, *Proceedings of IEEE/ASME International Conference on Advanced Intelligent Mechatronics*, pp.1123-1128.
- Jia, S. Hada Y., Ye, G. and Takase, K. (2002), Distributed Telecare Robotic Systems Using CORBA as a Communication Architecture, *Proc. of IEEE Int. Conference on Robotics and Automation*, (ICRA'2002), Washington, DC, USA, pp. 2002-2007.
- Lin, W., Jia, S., Fei, Y., Takase, K. (2004), Topological Navigation of Mobile Robot using ID Tag and WEB Camera, *The 2007 IEEE International Conference on Mechatronics and Automation*, pp. 644-649.
- Maeyama, S., Yuta, S. and Harada, (2000), A. Experiments on a Remote Appreciation Robot in an Art Museum, *Proc. of 2000 IEEE/RSJ Conference on Intelligent Robots and Systems*, Japan, pp. 1008-1013.
- Message-orientated middleware:
<http://sims.berkeley.edu/courses/is206/f97/GroupB\mom>.

- Nagi, N. Newman, W.S., Liberatore, V. (2002), An experiment in Internet-based, human-assisted robotics, *Proc. of IEEE Int. Conference on Robotics and Automation (ICRA'2002)*, Washington, DC, USA, pp.2190-2195.
- Object Management Group, <http://www.omg.org>.
- Object Oriented Concepts, Inc., <http://www.omg.org>.
- Schulz, D., Burgard, W., Fox, D. et al.: (2002), Web Interface for Mobile Robots in Public Places, *IEEE Robotics and Automation Magazine*, 7(1), pp. 48-56.
- Stein, M. R. Stein, (2000), Interactive Internet Artistry, *IEEE Robotics and Automation Magazine*, 7(1) (2000), pp. 28-32.
- R. J. Yarger, G. Reese, T. King and A. Oram, (1999), *MySQL and mSQL*, Publisher: O'Reilly & Associates, Incorporated.
- Wang, K. Jia, S., Lin, W. and Takase, K. (2003), Operation of Mobile Robot by Voice and Touch Panel, *System Integration*, 114-4.



Human Robot Interaction

Edited by Nilanjan Sarkar

ISBN 978-3-902613-13-4

Hard cover, 522 pages

Publisher I-Tech Education and Publishing

Published online 01, September, 2007

Published in print edition September, 2007

Human-robot interaction research is diverse and covers a wide range of topics. All aspects of human factors and robotics are within the purview of HRI research so far as they provide insight into how to improve our understanding in developing effective tools, protocols, and systems to enhance HRI. For example, a significant research effort is being devoted to designing human-robot interface that makes it easier for the people to interact with robots. HRI is an extremely active research field where new and important work is being published at a fast pace. It is neither possible nor is it our intention to cover every important work in this important research field in one volume. However, we believe that HRI as a research field has matured enough to merit a compilation of the outstanding work in the field in the form of a book. This book, which presents outstanding work from the leading HRI researchers covering a wide spectrum of topics, is an effort to capture and present some of the important contributions in HRI in one volume. We hope that this book will benefit both experts and novice and provide a thorough understanding of the exciting field of HRI.

How to reference

In order to correctly reference this scholarly work, feel free to copy and paste the following:

Songmin Jia and Kunikatsu Takase (2007). Development of Service Robot System With Multiple Human User Interface, Human Robot Interaction, Nilanjan Sarkar (Ed.), ISBN: 978-3-902613-13-4, InTech, Available from: http://www.intechopen.com/books/human_robot_interaction/development_of_service_robot_system_with_multiple_human_user_interface

INTECH
open science | open minds

InTech Europe

University Campus STeP Ri
Slavka Krautzeka 83/A
51000 Rijeka, Croatia
Phone: +385 (51) 770 447
Fax: +385 (51) 686 166
www.intechopen.com

InTech China

Unit 405, Office Block, Hotel Equatorial Shanghai
No.65, Yan An Road (West), Shanghai, 200040, China
中国上海市延安西路65号上海国际贵都大饭店办公楼405单元
Phone: +86-21-62489820
Fax: +86-21-62489821

© 2007 The Author(s). Licensee IntechOpen. This chapter is distributed under the terms of the [Creative Commons Attribution-NonCommercial-ShareAlike-3.0 License](#), which permits use, distribution and reproduction for non-commercial purposes, provided the original is properly cited and derivative works building on this content are distributed under the same license.