

Connected Crawler Robot – Design and Motion Planning for Climbing a Step

Sho Yokota

*School of Bionics, Tokyo University of Technology
Japan*

1. Introduction

The application fields of autonomous mobile robots recently extend from indoor uses to outdoor uses. Rescue systems and planetary explorations are typical examples for such outdoor mobile robots. In such field, it is required to have both of rapid movement and adaptive function to rough terrain, while general wheel mechanisms are not suitable for such rough environment. To move in such environments, the robots need to be flexible to various environment.

There are many researches concerning rough terrain mobile robots for rescue and planetary exploration. In such field, the robots require high mobile ability on rough terrain. When we design such kinds of robot, It become very important to choose the mechanism as a mobile platform. Several types of mechanisms have been proposed as a mobile platform: Crawler type, wheel type, leg type, and their combinations.

Wheel type mechanism is the simplest mechanism and can be controlled easily, but in terms of moving on rough terrains, its performance is obviously inferior to the other two mechanisms. If we adopt wheel type and try to get enough mobility on slight obstacles, we have to utilize pretty large wheels.

The leg mechanism is able to adapt various kind of environment, but, its weak points are low energy efficiency and complicated mechanism and control, that imply high cost and product liability problems. Those might be high barrier to develop them as a consumer product.

The crawler mechanism shows the high mobile ability on various terrains; moreover it is simple mechanism and easy to control. Therefore a lot of rough terrain mobile robots adopt a crawler mechanism.

However conventional single track mechanism has also mobility limitations; the limitation is determined by attacking angle, radius of sprockets, and length of crawler. In order to improve its mobility, it is required to adjust the attack angle against the obstacles, enlarge the radius of its sprockets, and lengthen its crawler tracks. And the mobility on the area like the stairs is inferior to that of the leg (S. Hirose, 2000). Therefore, a lot of researches have been done to supplement these weak points. The main theme common to those researches is to improve the mobility performance on rough terrain. Generally, the method which

changes the form of crawler is adopted as an approach for this main theme. In order to realize these transformations, many researches proposed the connected crawler mechanism. The purpose of this chapter is also to develop a connected crawler robot for rough terrain. The connected mechanism is that; some stages with motor-driven crawler at its left and right side are serially connected by active joints. When this mechanism is adopted, it becomes problem that how many crawler stages should be connected.

Lee et al (C.H. Lee et al, 2003) designs the mechanism of two stages one joint type that uses two triangular crawlers, and shows the high mobility performance by the comparison of climb-able step height between proposed mechanism and a conventional one track type. "Souryu-III" (T. Takayama et al, 2004) is the connected crawler robot of 3 stages 2 joints type, and it shows high mobility by using some basic experiments such as climbing a step and stepping over a gap. "MOIRA" (K. Osuka & H. Kitajima, 2003) is 4 stages 3 joints type connected crawler, and it reports the maximum climb-able step height which was measured by some experiments.

As mentioned above, the mobility performance was improved by the number of stages. However this number was different in each research. The mobility performance was also evaluated by using different experiment and criterion.

Although we can observe such researches, there are no researches which show the standardized relationship between the number of stages and mobility performance. When a connected crawler mechanism is designed, there is no design guideline which indicates how many stages would be optimal. That is a big problem, because the number of stages is influenced to mobility performance strongly.

Therefore this chapter derives the each actuator's motion which conforms to the environments, and tries to demonstrate the relationship between the number of stages and mobility performance. Especially, we set the environment as one step, and derive its relationship (Fig.1). Because the climbing step ability is important factor as one of the most fundamental mobility index (T. Inoh et al, 2005), moreover a climbing step experiment is adopted by many researches as an evaluation experiment for mobility performance on rough terrain. Thus this chapter shows sub-optimal number of crawler stages for connected crawler robot which isn't cleared, through demonstrating the relationship between the number of stages and maximum climb-able step height. After that, it proposes the actual connected crawler robot, and show basic experimental result.

2. Deriving the Sub-optimal Number of Crawler Stages

In order to find sub-optimal number of crawler stages, we derive the maximum climb-able step height of n -stages crawler ($n=2\sim 10$). In this derivation, there is an optimization problem for the joint motions. Because, if the joint can't realize suitable motion for the step, it might be impossible to exercise climbing ability which the mechanism has. Therefore, the optimized joint motions for the step are required. We set the environment to one step (Fig. 1), and then we try to solve the motion planning of each joint and derive the maximum climb-able step height.

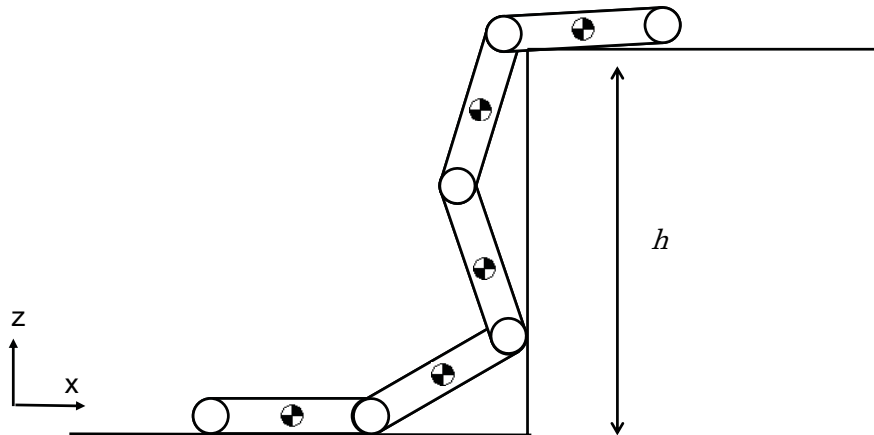

Fig. 1. The assumed case

The motions of climbing a step are divided into 2 phases which shown in Fig.2.

1. Lifting up crawlers phase
This motion is strongly influenced by friction forces, contact forces and impact forces between environments and crawlers.
2. Passing over phase
In order to generate a clock wise moment at the point of edge of the step and crawlers, the robot has to change its posture. This motion is strongly influenced by friction, balance of centre of gravity of the robot and inertia.

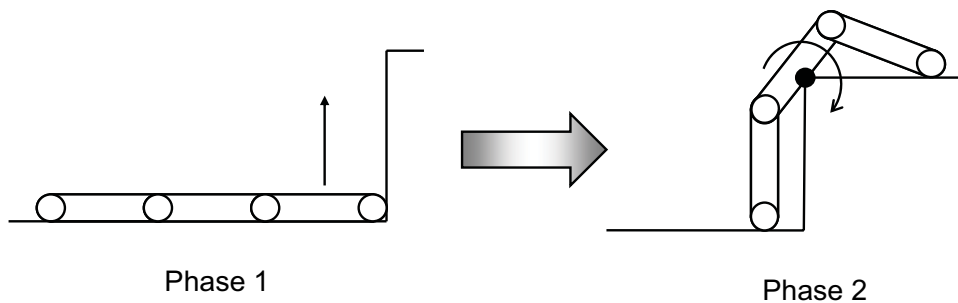

Fig. 2. The phases of climbing up a step

In each phase, changing the robot's posture is important. If the robot can not lift up the body as high as possible in Phase 1, the maximum climb-able step height can not be derived. Even if the robot can lift up the body as high as possible in Phase 1, if the robot can not generate the clock wise moment at the point of step edge, the climbing up a step can not be realized. Therefore, it is need to consider not only the moment in phase 2 but also both of Phase 1 and Phase 2. The maximum climb-able step height is distinguished by changes of postures. That is to say, the problem of driving the maximum climb-able step height is the optimization problem of each joint motion. If the each joint can not realize suitable motion to

the environment, it is impossible to exercise the ability of step climbing of the robot as maximally as possible. Thus the each joint motion is required to realize the suitable motion to the environment. But it is almost impossible to solve this problem by using analytical methods, because the amount of patterns of changing postures (from Phase 1 to Phase 2) becomes fatness by increasing the number of crawler stages. Thus the motion of each joint is required to be derived by using a certain searching method. However, the round robin-like searching method isn't so realistic, because the amount of searching becomes fat and calculation time becomes enormous.

Therefore, we propose the following idea as one of the approach to solve this problem. If certain approximate function can express an optimal joint motion in a few parameters, the required joint motion can be derived in shorter time than a round robin-like search. Therefore we try to express each joint angle function by using approximate function and search the parameters in this function. Thus the problem of the parameter searching can be substituted for the problem of the trajectory searching.

Moreover the robot has to change its posture with taking into interactions with environment, in order to climb a maximum step height.

2.1 Proposed Method

In previous section, we described each joint motion are determined by certain approximate function, and to search parameters in this approximate function. In the following parts, we will mention the approximate function and how to search parameters, and show the method to derive maximum climb-able step height.

2.1.1 The Approximate Function

There are n-order approximation, a Taylor progression, a Fourier series, a spline function, and so on, as an available approximate function. The approximate function must be possible to differentiate twice, so as to find an angular velocity and angular acceleration. It is also required that the function is periodic, and has a few parameters, and contains boundary conditions. Therefore, Fourier series is useful function to satisfy these conditions (Y. Yokose et al, 2004) . Thus, Fourier series approximates a joint angle functions. And the equation (1) is Fourier series for this approximation,

$$\theta_n(t) = \sum_{i=0}^j \alpha_i \cos \frac{i}{T} 2\pi t + \sum_{i=0}^j \beta_i \sin \frac{i}{T} 2\pi t \quad (1)$$

Here, n means the number of joints, j refers to the number of order of Fourier series, T means the period. α_i , β_i , T are parameters which are searched.

2.1.2 Searching for Parameters in the Fourier Series

Searching for each coefficient and period in the Fourier series corresponds to the problem which is to derive the optimized answer in a wide area. There are many approaches to solve such optimization problems. Many researches proposed to use GA for such a problem (Mohammed, 1997) ~ (S. Kawaji et al, 2001). Because, GA is able to find comparatively an excellent answer in the utility time, and fit various problems. Therefore this chapter also

adopts GA to search unknown coefficients in the Fourier series. We use simple GA (S. Kobayashi et al, 1995), and set following parameters (Table. 1).

| | |
|--------------------------------------|----|
| Number of chromosomes | 10 |
| Gene Length for one coefficient[bit] | 10 |
| Crossover rate [%] | 25 |
| Mutation rate[%] | 1 |

Table 1. Parameters of GA

We also set the equation (2) to evaluate the chromosomes.

$$E = h + \frac{1}{t} + \frac{\sum_{i=1}^n x_i + \sum_{i=1}^n z_i}{1000} \tag{2}$$

Here, h is the step height which the robot could climb up, t is the time for climbing up a step. Then, it is understood that the evaluation is high when the robot could higher step in shorter time. On the other hand, when the robot couldn't climb a step, we set $h=0$, $t=100$ as a penalty. However, in these conditions, the evaluation of gene which couldn't climb up a step becomes equal, and it makes difficult to execute crossover. Therefore the third clause of the equation (1.2) exists as the valuation item. Here, x_n, z_n are the centre of gravity coordinates of each stage. Thousand in the denominator is numerical value to scale it 1000 down .

2.1.3 The Method to Derive the Maximum Climb-able Step Height

In order to evaluate gene, we have to acquire appropriate position of centre of gravity in each stage and distinguish whether the robot could climb or not. Because mobility performance of the mobile mechanism concerns with topography characteristic closely, the consideration of the interaction with the environment is very important. Therefore we must consider dynamics and an interaction between robot and environment, for appropriate acquisition of centre of gravity position and distinction of climbing. Thus we adopt ODE(Open Dynamics Engine)(R. Smith) to calculate these values. ODE is open source software, and is adopted by many robotic simulators to calculate dynamics. We derived maximum climb-able step height by integrating ODE and GA. The calculation System is shown in Fig.3.

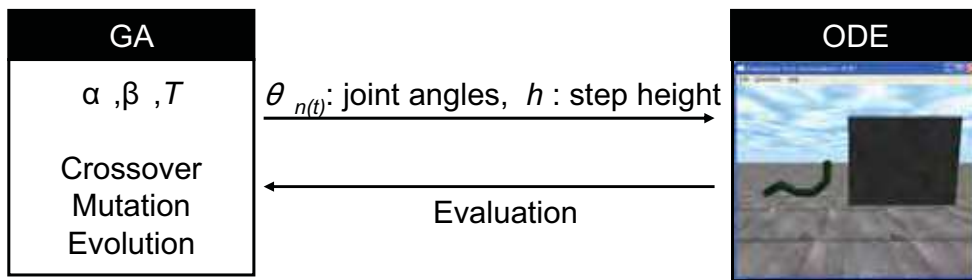

Fig. 3. Proposed simulation system

GA gives joint angles and step height, and ODE calculate dynamics. After that, ODE distinguishes whether the robot could climb or not, and returns the evaluation to GA. GA makes a gene evolve, and optimizes joint angle function. Then the robot can climb higher step in shorter time. A robot is considered to climb a step, when all centres of gravity in each stage are higher than the height of the step h and it is on the right of A in Fig1.

2.2 Deriving the Maximum Climb-able Step Height of n -Stages

In this part, we derive maximum step height of n -stages based on the above mentioned method. We set the conditions and assumption as follows.

Each initial joint angle is set $0.0[\text{rad}]$, and the range is $-2.0 \sim 2.0[\text{rad}]$. The range of Fourier coefficients is $-2.0 \sim 2.0$. The range of Fourier series period T is $10 \sim 60[\text{sec}]$, and the order of Fourier Series is 5. The initial genes are determined randomly. The specifications of the connected crawler robots are shown in Table. 2 and Fig. 4. Other conditions are as follows.

| | |
|----------------------------|-----|
| Total length L [m] | 2 |
| Total mass M [kg] | 2 |
| Radius of the sprocket [m] | 0.1 |

Table. 2. Parameters of the connected crawler robot

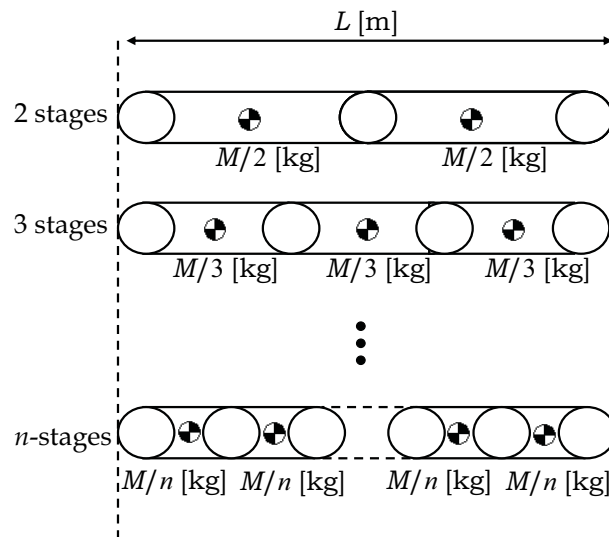

Fig. 4. The dividing definition of the robot

- Each stage is divided in constant total length L by corresponding to the number of links.
- The crawler velocity is constant $0.1[\text{m/s}]$.
- The actuators have enough torque for driving joints.

The range of step height h is 0.5 ~ 2.0[m], because the total length of connected crawler is $L=2.0$ [m]. By using above conditions, the simulation is done which is 4 stages and the number of generations is 500. Then the maximum climb-able step height is derived.

2.3 Results

The results are shown in Fig.5 ~ Fig. 7.

In the Fig. 5, we can confirm that the robot could climb higher step when the number of generations is increased, and time for climbing was shortened.

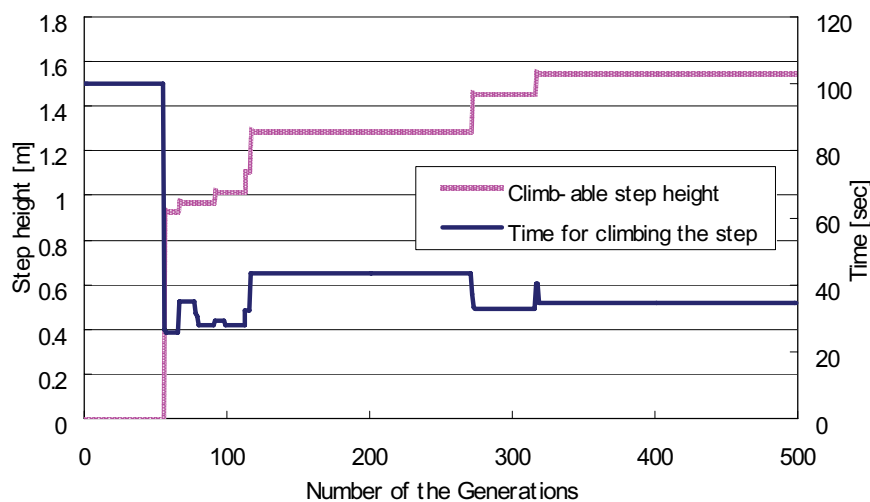

Fig. 5. Transition of the climb-able step height derived by GA (4 stages)

Fig.6 and Fig. 7 are snapshot when the robot is climbing up a step. In Fig.6, the height of step is 0.9[m] and the number of generations is 56. In Fig.7, the height of step is 1.544[m] (this is the maximum climb-able step height of 4 stages). From these figures, the climb-able step height becomes higher and the motions of the joints are changed when the number of generations is increased.

We also derive the maximum climb-able step height of 2 ~ 10 stages by using same method. The results are shown in Fig.7. It is confirmed that the robot can climb higher step when the number of generations is increased as well as the case of 4 stages, and maximum climb-able step height of each link is derived.

Since the maximum climb-able step height of each stage has been shown in Fig.8, the relationship between the number of stages and mobility performance of connected crawler is demonstrated in Fig.9.

By this figure, it is able to be derived that the sub-optimal number of stages for connected crawler is 5. Because it is turned out that the mobility performance is saturated more than 5 stages. Thus we can get the answer against the question that how many crawler stages should be connected, namely that is 5 stages.

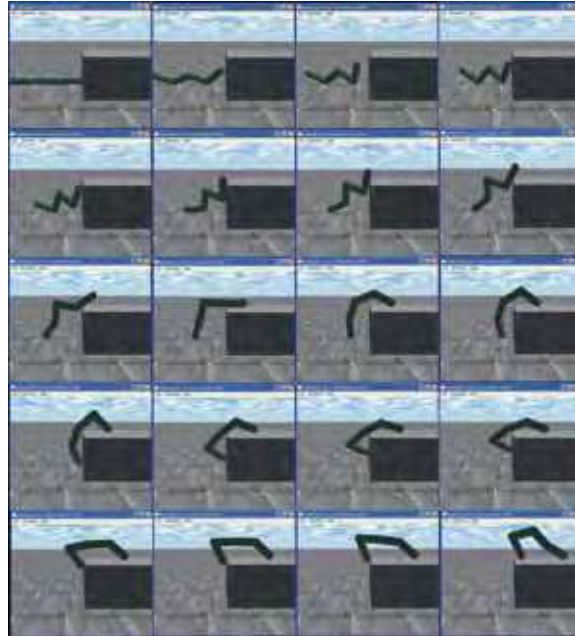

Fig. 6. Connected Crawler robot climb the step by using sub-optimized joint motion by GA (4 stages, $h=0.9$ m, 56 generations)

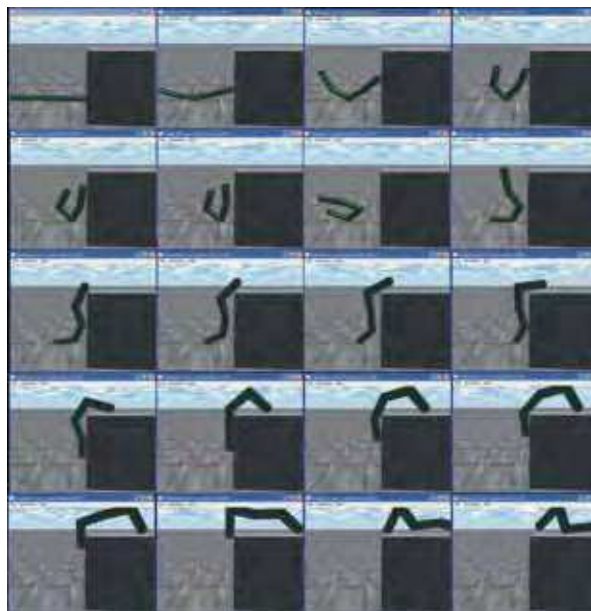

Fig. 7. Connected Crawler robot climb the step by using sub-optimized joint motion by GA (4 stages, $h=1.544$ m, 500 generations)

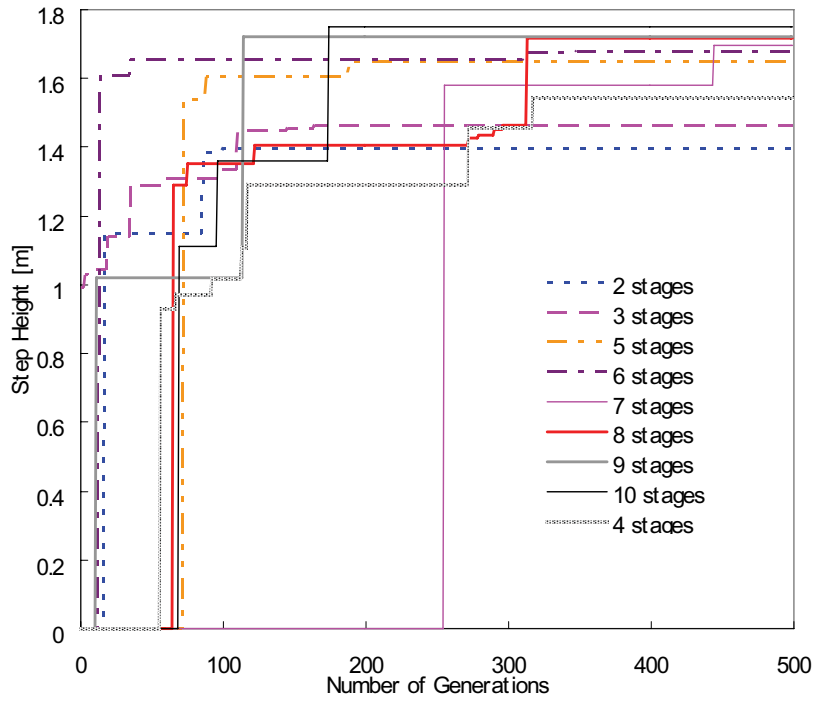

Fig. 8. Transition of the climb-able step height derived by GA (2 ~ 10 stages)

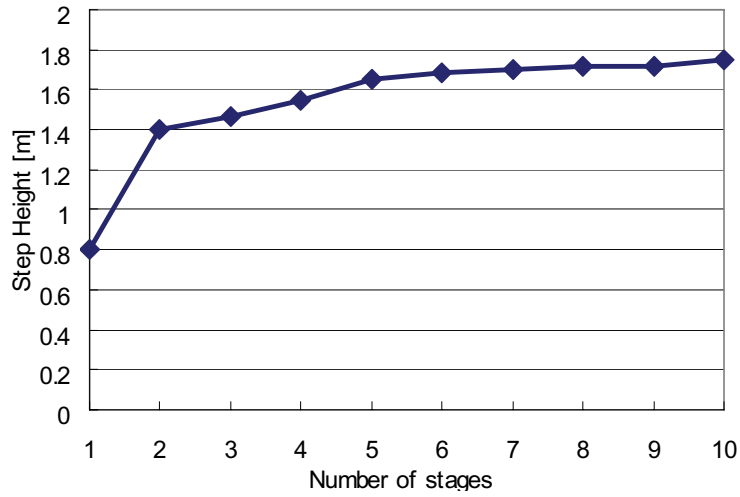

Fig. 9. Relationship between the number of stages and climb-able step height

3. Constructing the Prototype

In the previous section, we have been able to obtain the sub-optimal number of crawler stages, that is 5. Based on this conclusion, we have designed and developed the prototype of connected crawler robot. It is shown in Fig. 10. The length is 0.59 m, width is 0.130 m, mass is 1.28 kg.

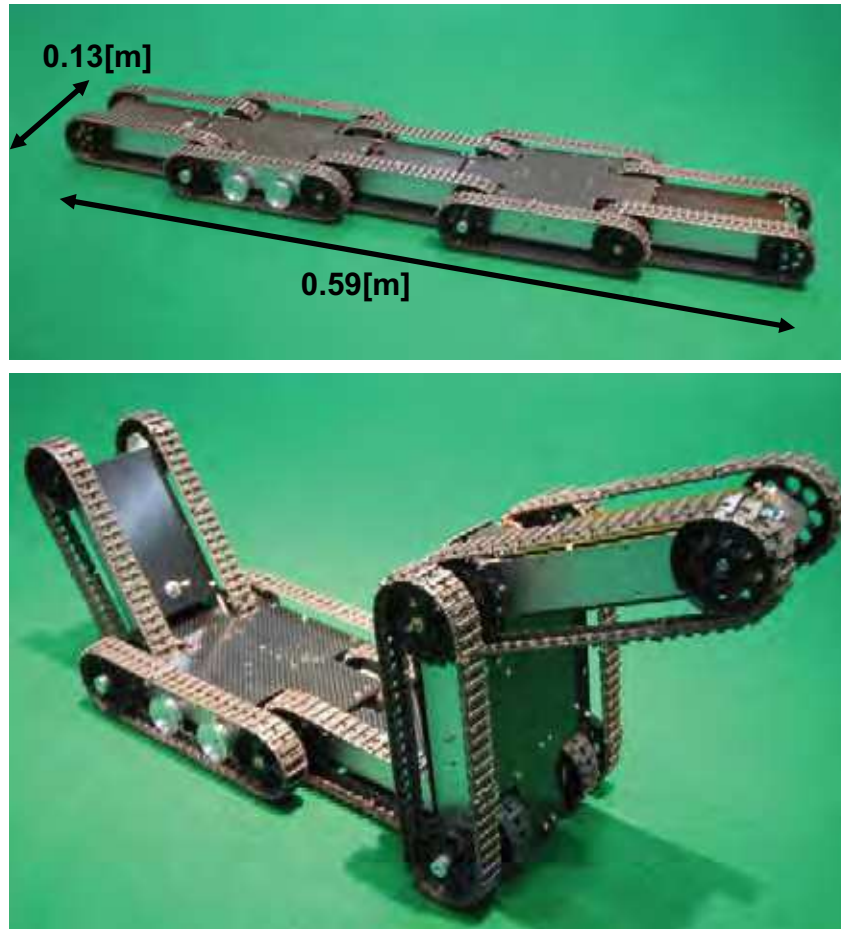

Fig. 10. Prototype of connected crawler robot

3.1 Mechanical Structure

Our mechanism has 5 connected stages with the motor-driven crawler tracks on each side (Fig. 11). RC-servo motors are used for driving joints between the stages. The left and right crawlers are driven by 4 DC motors independently, while the 5 crawlers on each side are driven by a motor simultaneously. The output of each motor is transmitted to the sprockets of the three or two crawlers through several gears (Fig.12).

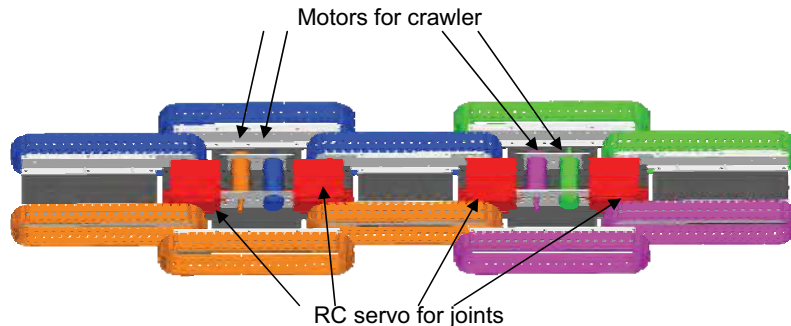

Fig. 11. The driving structure (Color indicates driving relationship between motors and crawlers)

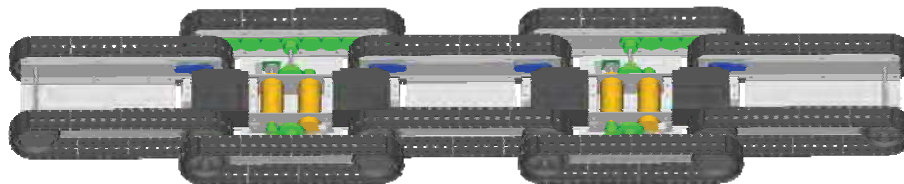

Fig. 12. Transmission of motor outputs to the crawlers

3.2 Control Structure

The control architecture is hierarchical structure by connecting master controller and servo unit (Fig. 13, and Fig. 14).

The servo units control low level task: crawler velocity and joint angle by PID control law. Each servo unit consists of one microcontroller (PIC16F873) and 2 DC motor drivers (TA8440H). One microcontroller is installed to control two RC-servo units for the joint control, where RC-servo is controlled only by PWM signal. Master controller controls high level task: such as calculating robot trajectory. Table.3 shows the communication data format. The command sent by master controller consists of 3 bytes. First byte indicates mode ID and motor ID. The mode ID distinguishes 2 kinds of control modes: position control and velocity control. The motor ID is used for selecting motor to control. Second byte shows the data depends on control modes. The third byte is checksum.

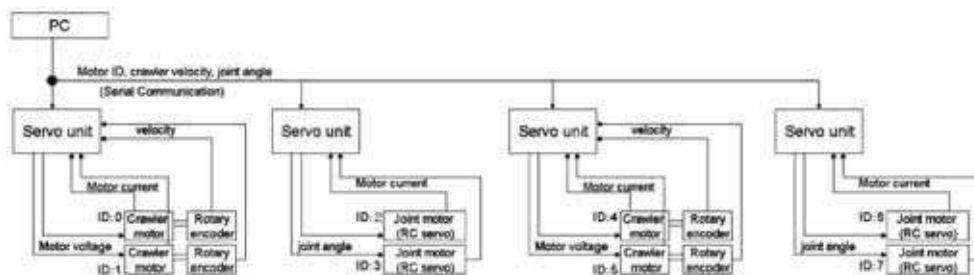

Fig. 13. The control system

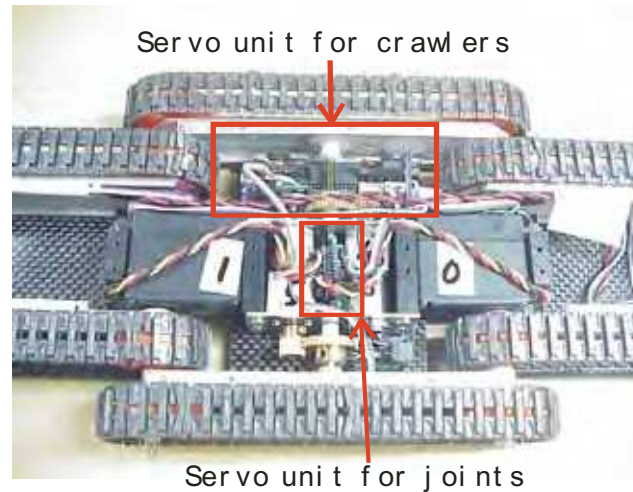

Fig. 14. The servo units

| 1 byte | | | | | | | | 2 byte | 3 byte |
|----------|---|--------|---|---|---|---|---|--------|------------------|
| Data 1 | | | | | | | | Data 2 | Check Sum |
| 7 | 6 | 5 | 4 | 3 | 2 | 1 | 0 | 0~254 | Data1 Data2 |
| Mode=0~2 | | ID=0~7 | | | | | | | |

Table. 3. Communication data format

4. Experiments

The climbing step experiment is conducted to verify the performance of our prototype. The height of step is 0.23 m. The master controller sends instructions to each actuator through servo units. Li-Polimer battery (1320mAh, 11.1V) is embedded to the robot for supplying electric power. In this experiment, PC is used as master controller. The USB cable is used for connecting robot to PC. The result is shown in Fig. 15. As we can observe, the robot can climb up a step. Therefore the mobility of this robot is confirmed.

5. Conclusion

This chapter showed sub-optimal number of crawler stages for connected crawler robot, through demonstrating the relationship between the number of stages and maximum climbable step height. After that, it proposed the actual connected crawler robot, and indicated basic experimental result. The conclusions of this chapter are as follows.

- A joint angle function was approximated by Fourier series and parameters were searched by GA.

- Due to fusion of GA and ODE, it has been possible to consider the interactions between robot and environment.
- The relationship between the number of crawler stages and mobility performance was cleared.
- Though mobility performance was raised by increasing the number of stages. However its increasing rate was small in comparison between before 5 stages and after 6 stages.
- Therefore the sub-optimal number of crawler stages is Five.
- By basic experimental results, the mobility of the prototype was confirmed.

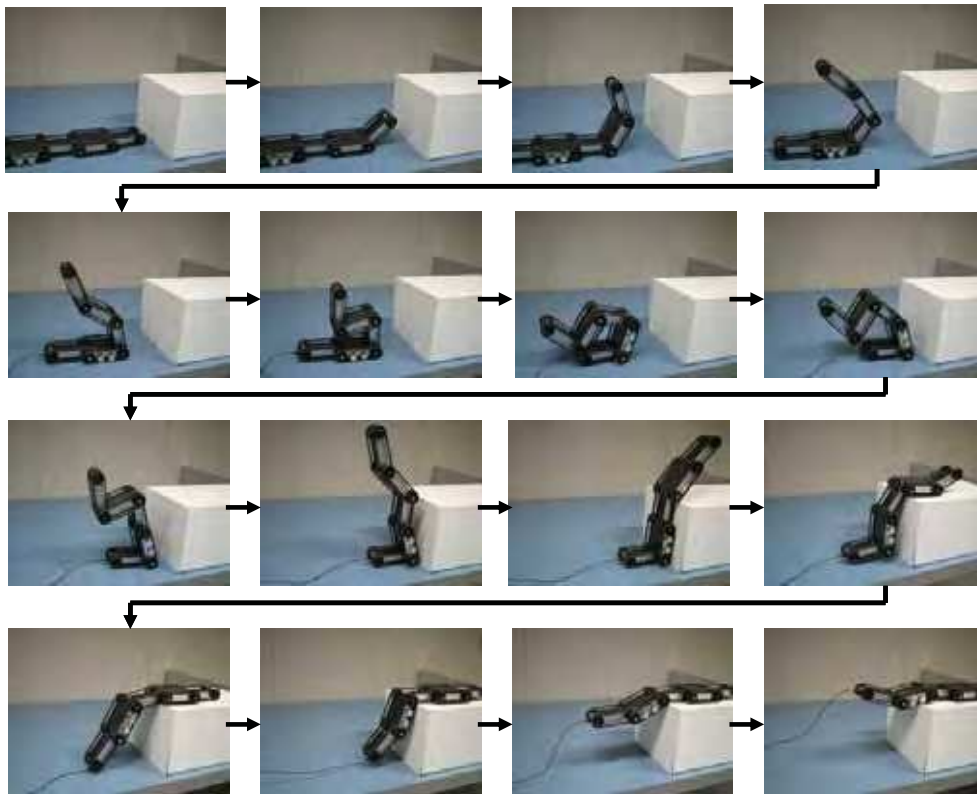

Fig. 15. Experimental results

References

- C.H. Lee, S. H. Kim, S. C Kang, M.S.Kim, Y.K. Kwak (2003). "Double -track mobile robot for hazardous environment applications", *Advanced Robotics*, Vol. 17, No. 5, pp 447-495, 2003
- K. Osuka, H. Kitajima (2003). "Development of Mobile Inspection Robot for Rescue Activities:MOIRA", *Proceedings of the 2003 IEEE/RSJ Intl. Conference on Intelligent Robots and Systems*, pp3373-3377, 2003

- Mohammed , G.F.Uler (1997). "A Hybrid Technique for the Optimal Design of Electromagnetic Devices Usign Direct Search and Genetic Algorithms" , *IEEE Trans. on Magnetics*, 33-2, pp1931-1937, 1997
- R. Smith, "Open Dynamics Engine", <http://ode.org/>
- S. Hirose (2000). "Mechanical Designe of Mobile Robot for External Environments", *Journal of Robotics Society of Japan*, Robotics Society of Japan, vol.18, No.7, pp904-908, 2000 (in Japanese)
- S. Kawaji et al, (2001). "Optimal Trajectory Planning for Biped Robots" , *The Transactions of the Institute of Electrical Engineers of Japan. C*, vol.121, No.1, pp282-289, 2001 (in Japanese)
- S. Kobayashi et al, (1995). "Serarch and Learning by Genetic Algorithms" , *Journal of Robotics Society of Japan*, vol.13, No.1, pp57-62, 1995 (in Japanese)
- T. Inoh et al (2005). "Mobility of the irregular terrain for resucue robots" , 10th Robotics symposia , pp 39-44, 2005 (in Japanese)
- T. Takayama, et al (2004). Name of paper. "Development of Connected Crawler Vehicle "Souryu-III" for Rescue Application " , *Proc. of 22nd conference of Robotics Society of Japan CD-ROM*, 3A16, 2004 (in Japanese)
- Y. Yokose et al (2004). "Minimization of Dissipated Energy of a Manipulator with Coulomb Friction using GA Increasing the Calculated Genetic Information Dynamically" , *Transaction of JSCES*, Paper No.20040024, 2004 (in Japanese)
- Y.Yokose , V.Cingosaki, H.Yamashita (2000). "Genetic Algorithms with Assistant Chromosomes for Inverse Shape Optimization of Electromagnetic devices" , *IEEE Trans. on Magnetics*, 36-4, pp1052-1056, 2000



Climbing and Walking Robots: towards New Applications

Edited by Houxiang Zhang

ISBN 978-3-902613-16-5

Hard cover, 546 pages

Publisher I-Tech Education and Publishing

Published online 01, October, 2007

Published in print edition October, 2007

With the advancement of technology, new exciting approaches enable us to render mobile robotic systems more versatile, robust and cost-efficient. Some researchers combine climbing and walking techniques with a modular approach, a reconfigurable approach, or a swarm approach to realize novel prototypes as flexible mobile robotic platforms featuring all necessary locomotion capabilities. The purpose of this book is to provide an overview of the latest wide-range achievements in climbing and walking robotic technology to researchers, scientists, and engineers throughout the world. Different aspects including control simulation, locomotion realization, methodology, and system integration are presented from the scientific and from the technical point of view. This book consists of two main parts, one dealing with walking robots, the second with climbing robots. The content is also grouped by theoretical research and applicative realization. Every chapter offers a considerable amount of interesting and useful information.

How to reference

In order to correctly reference this scholarly work, feel free to copy and paste the following:

Sho Yokota (2007). Connected Crawler Robot - Design and Motion Planning for Climbing a Step, Climbing and Walking Robots: towards New Applications, Houxiang Zhang (Ed.), ISBN: 978-3-902613-16-5, InTech, Available from:

http://www.intechopen.com/books/climbing_and_walking_robots_towards_new_applications/connected_crawler_robot_-_design_and_motion_planning_for_climbing_a_step

INTECH
open science | open minds

InTech Europe

University Campus STeP Ri
Slavka Krautzeka 83/A
51000 Rijeka, Croatia
Phone: +385 (51) 770 447
Fax: +385 (51) 686 166
www.intechopen.com

InTech China

Unit 405, Office Block, Hotel Equatorial Shanghai
No.65, Yan An Road (West), Shanghai, 200040, China
中国上海市延安西路65号上海国际贵都大饭店办公楼405单元
Phone: +86-21-62489820
Fax: +86-21-62489821

© 2007 The Author(s). Licensee IntechOpen. This chapter is distributed under the terms of the [Creative Commons Attribution-NonCommercial-ShareAlike-3.0 License](#), which permits use, distribution and reproduction for non-commercial purposes, provided the original is properly cited and derivative works building on this content are distributed under the same license.