

Advanced Techniques for Preparation of Strontium Aluminate Phases

1. Techniques using powder precursors

The solid state synthesis described in Chapter 4.3 is the traditional way for the synthesis of strontium aluminate phase. Small amounts of fluxing agents (Fig.1), such as B_2O_3 (H_3BO_3) or LiF can be used [749,810].

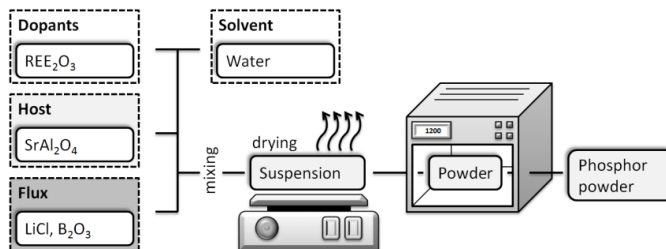

Figure 1. Flow chart of the preparation of REE doped $SrAl_2O_4$ phosphor powders [749].

There are also advanced techniques of the synthesis of strontium aluminate phases including the sol-gel process, the precipitation from solution, the pyrolysis and combustion techniques, the microwave synthesis, the mechano-chemical route, etc. It must be pointed, that the techniques mentioned in this chapter are the sophisticated synthesis routes which are tailored mainly for the processing of nano-scale powders, doped with rare earth elements (REE ions such as Ce^{4+} , Eu^{2+} , Dy^{3+} ...), in order to prepare the precursors for strontium aluminate based phosphors for long-persistent luminescence materials, electronic and structural applications (Chapter 10.1). Therefore, the suitability of the techniques mentioned above for the synthesis of strontium aluminate clinker is limited by their complexity, time-consuming preparation process, labor productivity and by the cost of applied chemicals.

The Sol-gel process is a method based on the turn of the “free dispersion system” with particles of colloidal size (**sol**) into “bound dispersion system” (**gel**) with the particles cross-linked into the three-dimensional network. In principle there are two ways of the formation of gel:

1. Linking of growing particles into chains, connection of chains into branched chains and then into domains of three-dimensional networks (**microgel**). As the regions of formed

gel phase grow and are connected to each other, the continuous network of gel (**lyogel**) is formed. The volume of formed gel is approximately the same as that of the original sol. The process of gradual displacement of liquid phase from gel is termed as **syneresis**.

The particles in sol may lose the stability (**DLVO theory**¹ [750]) due to ageing of sol (spontaneously) or by the change of pH or temperature, addition of electrolytes and mechanic action (mixing, ultrasound) and the formation of flocs takes place. The process of formation of these clusters is termed as **flocculation (agglomeration, aggregation** and more generally as **coagulation**). The gel (**coagel**) is formed by the connections between aggregates after sedimentation

The capillary forces generate the strain stress in gel during the evaporation of solvent and the solid framework falls into pieces of **xerogel**². Subsequent mechanical (grinding) and thermal treatment (calcination) lead to the powder precursor. According to the applied chemical the alkoxide-, semialkoxide-, Pechini-[751] and modified Pechini-route were recognized.

The sol–gel process is an efficient technique for the syntheses of phosphors due to good mixing of initial materials and relatively low reaction temperature resulting in more homogeneous products than those obtained by solid-state reaction synthesis method. The technique uses alkoxides and salts listed in Table 1. There are numerous modifications in applied solvent, pH, chelating agent as well as in the temperature and time of treatment, but the most general scheme of the synthesis includes these steps:

- a. **Dissolving of initial materials:** the kind of solvent or liquid depends on initial materials. Oxides are usually dissolved in HNO₃ of various concentrations. Water or water slightly acidified by the addition of several HNO₃ drops (in order to avoid the hydrolysis) is used for the dissolution of nitrates. Alkoxides are mixed with organic solvent (methanol, ethanol, propanol, ethylene glycol...) which enables to control the process of hydrolysis via defined amount of water (water to alkoxide ratio). Other important parameters are the catalysis, the temperature, the time and intensity of stirring.
- b. **Mixing of constituents:** chelating agents and pH adjusting chemicals are often used in order to avoid the undesirable precipitation and to improve the system homogeneity. For the Pechini and modified Pechini method [751,756] the ratio between chelating agent and metal cations is one of the most important parameters. Usually the value higher than one is used.
- c. **Concentrating of the solution and the formation of gel by the evaporation of solvent under stirring or by condensation reaction:** the prepared system is stirred for several hours. The required temperature (mostly in the range from 60 to 80 °C) and pH are kept constant during this time. The condensation reaction between chelating agent (most usually citric acid) and glycol requires an increase in temperature (100 – 150 °C), which is necessary for Pechini in order to obtain clear transparent color of viscous polymer [67,752,753]:

¹ Theory is named after Derjaguin B, Landau L, Verwey E and Overbeek J.

² There is an option to avoid these changes by drying gel under critical conditions in order to prepare aerogel.

Chemical	Compound name	Function	References	
Salts	$\text{Sr}(\text{CH}_3(\text{CO}_2))_2$	Strontium acetate monohydrate	Starting chemical	[758,759]
	$\text{Sr}(\text{NO}_3)_2 \cdot 4\text{H}_2\text{O}$	Strontium nitrate tetrahydrate		[755,756,760,765]
	SrCO_3	Strontium carbonate	[757]	
	$\text{Al}(\text{NO}_3)_3 \cdot 9\text{H}_2\text{O}$	Aluminium nitrate heptahydrate	[755,756,758]	
Alkoxides	$\text{Al}(\text{i-OC}_3\text{H}_7)_3$	Aluminium isopropoxide	[755,760]	
Water and organic liquids	H_2O	Water	Solvent	[759,760]
	HNO_3 (aq) ³⁾	Nitric acid		[759,765]
	$\text{C}_2\text{H}_5\text{OH}$	Ethanol		[765]
	$\text{C}_3\text{H}_8\text{O}_2$	2-methoxyethanol		[760]
Additives ¹⁾	$\text{C}_2\text{H}_5\text{OCH}_2\text{CH}_2\text{OH}$	Ethylene glycol monoethyl ether		[759]
	$\text{C}_3\text{H}_8\text{O}_3$	Glycerol, propan-1,2,3-triol		[759]
	$\text{C}_{2n}\text{H}_{4n+2}\text{O}_{n+1}$	PEG, Polyethylene glycol		[755-758]
	NH_4HCO_3	Ammonium bicarbonate	pH adjusting	[755]
	NH_4OH	Ammonium hydroxide		[757]
	CH_3COOH	Acetic acid	Chelating agent	[758]
	$\text{C}_6\text{H}_8\text{O}_7$	Citric acid		[756,757]
	$\text{C}_6\text{H}_{10}\text{O}_3$	Ethyl acetoacetate ⁴⁾		[760]
	$(\text{C}_6\text{H}_9\text{NO})_n$	PVP, Polyvinylpyrrolidone		[765]
	$\text{C}_3\text{H}_5\text{NO}$	Acrylamide		[761]
	$\text{C}_7\text{H}_{10}\text{N}_2\text{O}_2$	Methylene bisacrylamide		[761]
	$(\text{NH}_4)_2\text{S}_2\text{O}_8$	Ammonium persulfate	Radical initiator	[761]
	$\text{C}_6\text{H}_{16}\text{N}_2$	N,N,N',N'-tetramethylethylenediamin, TMEDA		[761]
Dopants ²⁾	$\text{Dy}(\text{NO}_3)_3 \cdot x\text{H}_2\text{O}$	Dysprosium (III) nitrate hydrate	Modification of luminescent properties	[755,756]
	$\text{Eu}(\text{NO}_3)_3 \cdot x\text{H}_2\text{O}$	Europium(III) nitrate hydrate		[755,760,756]
	$\text{Ce}(\text{NO}_3)_3 \cdot 6\text{H}_2\text{O}$	Cerium(III) nitrate hexahydrate		[758]

¹⁾ These chemicals form the polymeric network (Pechini and modified Pechini methods), avoiding undesirable precipitation via the formation of chelates with metal ions (complexing agent), initiators or chemicals maintaining the pH in the system.

²⁾ Dopants enhance nitrates of REE element, the product is termed as $\text{ArAl}_2\text{O}_4:\text{REE}$ (REE=Rare Earth Elements).

³⁾ Dissolution of oxides.

⁴⁾ In order to avoid the hydrolysis of alkoxide cations before mixing.

Table 1. Initial materials for the preparation of strontium aluminates via advanced techniques.

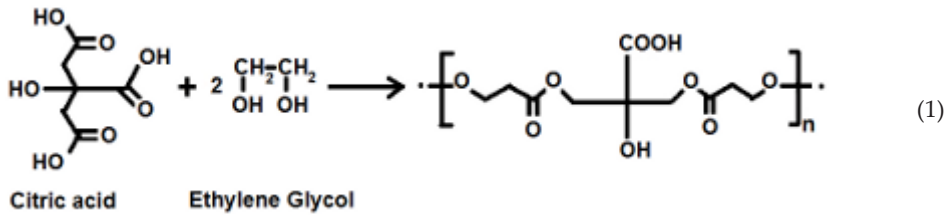

Modified Pechini methods uses EDTA [754] as chelating agent or does not apply glycol.

- d. **Drying of gel to xerogel:** the temperatures in the temperature range from 100 to 200 °C are often used. The time of drying varies from several hours to a few days.
- e. **Thermal treatment:** the pyrolysis of organic compounds and the calcination are two main processes which take place during this step. The temperatures higher than 400 °C applied for several hours are usually necessary in order to complete the removal of organics, but the course of process is highly affected by the nature of applied chemicals, by heating rate and by kiln atmosphere (static, inert, oxidative or reductive). The temperatures about 600 °C are usually applied. The removal of carbon formed under the reductive conditions (or site reduction conditions) often requires much higher temperatures and affects the oxidation state of metal cations via the p_{co}/p_{co_2} ratio. Low partial pressure of oxygen also supports the formation of various organic compounds during the pyrolysis. At sufficient temperature, the solid-state reaction takes place during the process of calcination. Much higher temperature may cause the material to reach an undesirable degree of sintering which complicates the preparation of fine powder of the precursor. The calcination temperature of 900 °C is usually used for the preparation of strontium-aluminate precursor.
- f. **Mechanical treatment of xerogel into the fine powder of precursor:** the calcined product is ground into fine powder of the precursor. This operation does not require any extensive force as porous and very brittle product is prepared. Some times the hand grinding in porcelain or agate dish is performed.

The prepared powder of precursor can be shaped by pressing, cold-isotactic pressing [762] or hot-isotactic pressing (HIP) [371]. Another option is the preparation of paste or suspension which can be deposited onto the substrate (e.g. by dip-or spin-counting [763,764], electrophoretic deposition, slip-or solution casting [761,764]...) or casted into the mould. The subsequent thermal treatment including the synthesis of required phases and the sintering can be performed in the furnace or by special sintering techniques. The method is schematically shown in Fig.2.

The possibility to prepare pure and fine product of good homogeneity under low processing temperature is the main advantage of the sol-gel method. The synthesis of $SrAl_2O_4:REE$ fibers via the combination of electro-spinning with the sol-gel process were described by Cheng at al [765]. Ceramics can not be electrospun directly to fibers from the solution. Recently, the

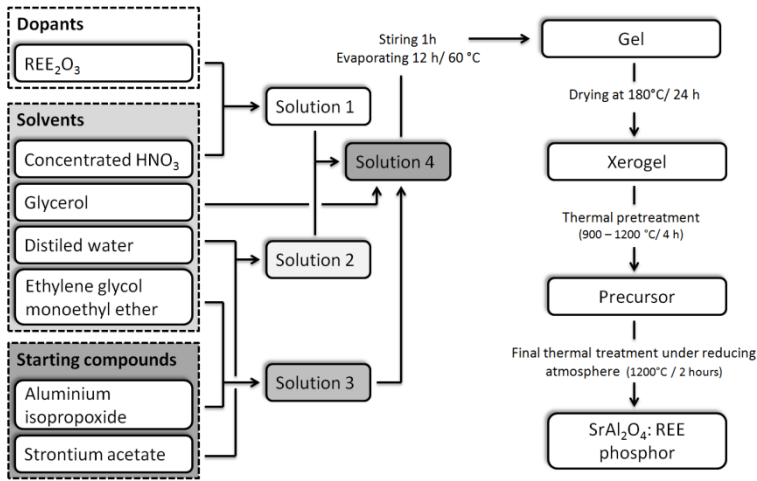

Figure 2. General scheme of the sol-gel process.

electro-spinning combined with the sol-gel process is being widely employed to fabricate the ceramics fibers.

The **precipitation method** or the chemical precipitation method exhibits some advantages, such as low processing temperature, high homogeneity and the purity of products. By this method, the nano-sized particles which are uniformly distributed, could be prepared [766]. In this method, a solution of the precursor reactants is mixed with dopants in an acid solution. Once the desired compound precipitates, the sample is centrifuged and washed repeatedly. The precipitate is treated at high temperature, then cooled and ground to the precursor of desired grain size [767]. The solvothermal co-precipitation synthesis uses an autoclave in order to prepare the precipitate under hydrothermal conditions [768,769].

The **combustion synthesis** techniques are classified according to the physical nature of the initial reaction medium [776]:

- Solution-combustion synthesis (SCS) where the initial reaction medium is aqueous solution.
- Conventional SHS method where the reactants are in solid state (condensed phase combustion).
- Flame synthesis, i.e. gas phase combustion.

The **solution-combustion method** is based on the preparation of mixture of nitrates of metal cations ($\text{Sr}(\text{NO}_3)_2 \cdot 4\text{H}_2\text{O}$, $\text{Al}(\text{NO}_3)_3 \cdot 9\text{H}_2\text{O}$) and dopants such as $\text{REE}(\text{NO}_3)_3$ with organic fuel (urea, $\text{CO}(\text{NH}_2)_2$). The temperature ranging from 60 to 80 °C is mostly used for this operation. The continuous stirring, lasting from several minutes to one hour, ensures the homogenization of mixture. The evaporation and recrystallization of the product provide the solution, gel, foam or fine powder for subsequent thermal treatment. The combustion is fast process (a few

minutes) which takes place after introducing the sample into the furnace heated to the temperatures from 400 to 600 °C. The temperature during the combustion may reach 1100 °C. The voluminous foamy ash after the combustion is then ground and used as a precursor for the flame-pyrolysis of oxide powder for the synthesis of strontium aluminates [770-773].

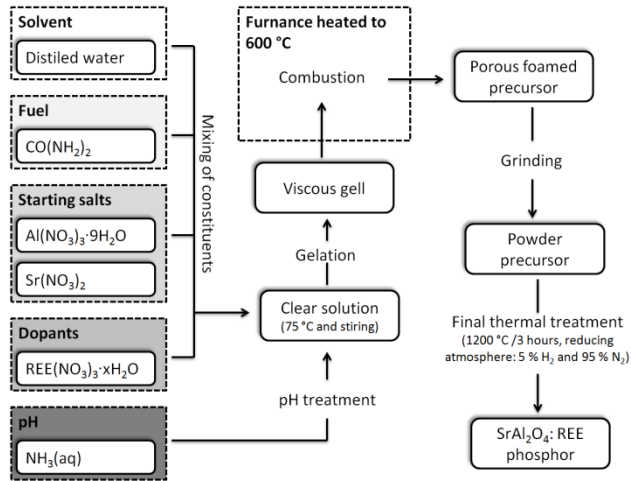
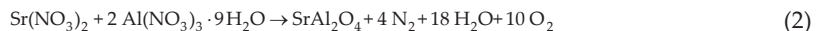

Figure 3. Scheme of the combustion method.

Final thermal treatment in a weak reductive atmosphere leads to the SrAl₂O₄:REE phosphor [772]. It is obvious that the preparation is much faster if compared to the sol-gel process, but there is only a limited chance to control the conditions of thermal treatment. Fast formation of large amount of gases and the swelling of material may cause the losses of precursor. The method is schematically shown in Fig.3.

The **Detonation method** of the synthesis of SrAl₂O₄ was described by Li et al [774]. The detonation method is an efficient technique for the preparation of nanometer powders because of good mixing of the initial materials. At the same time, the size of prepared particles can be controlled to a certain extent by adjusting the detonation parameters; the production cost is lower compared to sol-gel process and the process can be finished in a short interval of time. During the detonation synthesis process, the mixtures composed of raw materials can undergo complex physical and chemical reactions and have series of changes, such as the conglomeration, the crystallization and the phase-translation at high temperature.

When exploding and decomposing, nitrates can release great quantum of oxygen. So they can be used as oxidizers or accessorial oxidizers in dynamite. The main equations of the reaction of detonation can be expressed as follows:



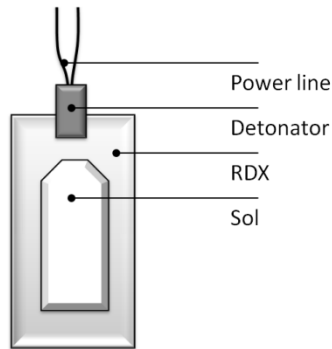

Figure 4. Schematic presentation of detonation method for the synthesis of strontium aluminate [774].



It is believed that the detonation products do not have enough time to grow into large and perfect crystallites, when the mixture is subjected to shock waves. The detonation products mainly consist of particles with very small sizes containing high density of defects and dislocations [774,775].

The **self-propagating high-temperature synthesis** (SHS) is one of the combustion methods [776-779] which uses strong exothermic reactions for the preparation of oxide ceramics [780], non-oxide ceramics [778,781-785] and cermets [786-789]. After mixing the powder of initial solid reactants and shaping (pressing, isotactic pressing) it the exothermic self-catalysed reaction is initiated. Once initiated, the combustion front becomes self-sustained, traveling through the sample due to the sufficient liberation of reaction heat and the final product is formed progressively with no additional heat required. The method can be applied whenever a sufficiently exothermic chemical reaction is available.

For example, strong affinity of aluminium to oxygen causes, that the formation of aluminium oxide is a strong exothermic reaction. The reaction is well known and used for the aluminothermic reactions³, which are of huge practical demand for the production of ferroalloys and welding of rail tracks. A tempting option arises to obtain the heat for the synthesis of strontium-aluminate via self-propagating high-temperature synthesis. SrAl_2O_4 was prepared by SHS method by Sathaporn et al [790] according to the general scheme in Fig.5.

Milling is known as one of important unit operations and is widely used in various processing of materials such as minerals, food, medicine, chemicals and building materials. As an

³ Discovered by Nikolay Beketov.

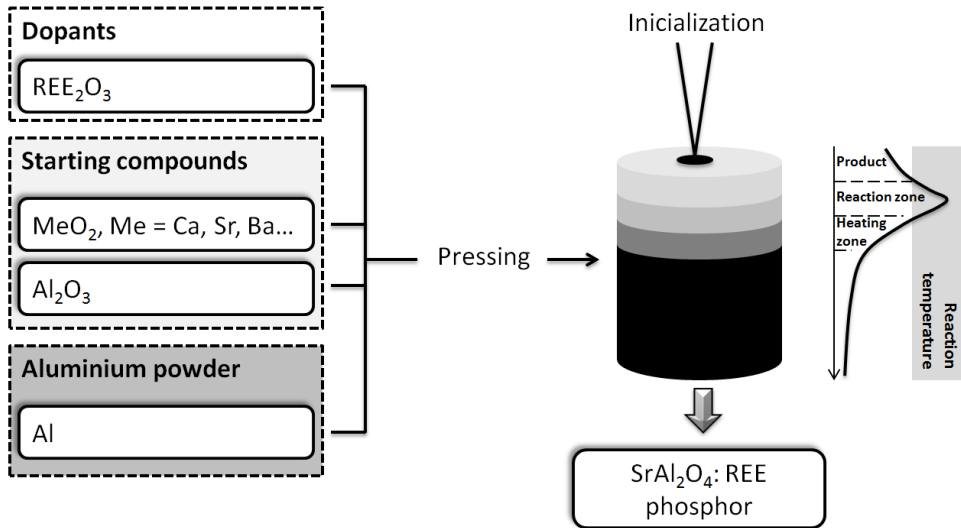

Figure 5. The flow diagram for the SHS synthesis of strontium aluminate.

extended branch in milling operations, the field of mechanochemistry has attracted much attention in recent years and the research papers on this topic have been increasing. One of unique phenomena in mechanochemistry is the solid state reaction among two or more multi-components without heating, to produce a constituent compound. A potential application for this solid state reaction is not only the material synthesis but also the separation and recovery of chemical species and components from minerals and waste materials treated by the reaction through another chemical and/or physical operation [791].

The boundary of two or multi-components of solid material may be activated by the following reasons: When the sample powders are trapped and crushed between two balls colliding inside a ball mill pot, they undergo plastic deformation, and are repeatedly flattened, cold-welded, fractured and rewelded. The force of the impact acts on the powder particles, leading to the breakage of crystallographic bonds and new surface is produced. The new created surfaces enable the particles to weld together easily and this leads to an increase in the rate of dissolution of solid material. Mechanical deformation produces new surface via the formation of fragments and the increase of surface energy of the material. Other profound changes affecting the surface as well as the chemical, physico-chemical and structural properties may also take place. This is proved by the presence of variety of crystal defects such as increased number of grain boundaries, dislocations, vacancies and interstitial atoms, stacking faults, and deformed and ruptured chemical bonds. The presence of such defect structure enhances the diffusivity of solute elements. Consequently, grinding a mixture of two or more solids substances results in the micro-homogenization of initial components, and sometimes, it induces the formation and synthesis of new fine powders [791-793].

The preparation of SrAl_2O_4 nanoparticles by CO_2 laser vaporization (LAVA) technology and laser melting method is described in works [794,795]. The LAVA technique is suitable for the preparation of a variety of ceramic nano-powders from coarse initial powders (usually oxides) although no specially designed precursors are required. The great advantage of the laser synthesis is the possibility to one-step, fast synthesis of these materials in air at the atmospheric pressure.

2. Preparation of crystals

The bulk single crystals of strontium aluminate can be prepared by the floating zone (FZ) or laser floating zone (LZF) method [796,797] or by the Czochralsky technique [26,798]

3. Preparation of thin layers

Thin film phosphors have several advantages over powders, such as higher lateral resolution from smaller grains, better thermal stability, reduced out gassing and better adhesion to solid substrates [799]. The following methods can be used for the preparation of thin films:

- i. **The Pulsed laser ablation (PLD):** is a preparatory technique with several attractive features, including the stoichiometric transfer of target material, the generation of quality plume of energetic species, the hyper thermal reaction between ablated cations and molecular oxygen in the ablation plasma and the compatibility with background pressures ranging from UHV to 100 Pa. The plasma produced during the pulsed laser ablation is very energetic and its mobility can be easily controlled by changing the processing parameters [799-804]. The process involves various phenomena such as the target heating, the material removal and the plasma shielding. The absorption of laser radiation heats the target and the vaporization of target material takes place. Plasma shielding causes the drop in the laser intensity reaching the target surface [805].
- ii. **Pulsed ion beam evaporation (IBE):** the method uses the high-power pulsed ion beam which is focused on the target. Formed high density ablation plasma enables to prepare thin film of material [806].
- iii. **Electron beam bombardment (EBB)** [807].
- iv. **RF magnetron sputtering** [808,809].

