

Kinematic Design and Description of Industrial Robotic Chains

Peter Mitrouchev

1. Introduction

Today, industrial robots can replace humans in carrying out various types of operations. They can as well serve machine tools as to carry out various tasks like welding, handling, painting, assembling, dismantling, foundering, forging, packaging, palletizing ...in different areas of the mechanical, car, aerospace, automotive, electronics ... and other industries. However, the complexity of the industrial process poses difficult problems for insertion and generation of the movements of a robot: the working environment of the robot is often complex and varied (presence of obstacles during the execution of a task for example).

One of the objectives concerning the problems of computer-aided design (CAD) of robots is the validation of their topological structures. The robot-design engineer puts forth assumptions as regards the provision of the links and the joints of the mechanical articulated system. A first validation of this choice is of a geometrical nature (Merlet, 1996). At first sight the design of a mechanical architecture for a robot appears rather simple and yet it presents a very complex basic difficulty, as it must take into account not only the mechanical possibilities of realization but also the possibilities of control's development, which passes by generating of a mathematical model. The latter strongly affects the mechanical design if good performances are sought. Many methods for mechanism description appeared with the creation of CAD systems (Warnecke, 1977) and (Coiffet, 1992). The existing methods may be separated into two categories:

- description methods for classification (Roth, 1976),
- methods for mathematical modelling (Borel, 1979), (Khalil, 1976), (Renaud, 1975) and (Touron, 1984).

Mechanisms and Machines Theory (MMT) contributed greatly to planar and spatial mechanism synthesis with different degrees of freedom (Hwang & Hwang, 1992; Hervè, 1994; Gonzales, 1996; Karouia & Hervè, 2005). Some of

the current industrial robots with planar chains have a structure created by the kinematic graphs of MMT (Manolescu et al. 1987; Ma & Angeles, 1991).

The morphological (topological) synthesis of kinematic chains has, for a long time, been the subject of many papers. There are different methods for number synthesis of planar kinematic chains with simple revolute joints, with different degrees of mobility and different numbers of links and joints. These chains are usually called “planar pin-joined” chains in MMT. While number synthesis originates from kinematics of mechanisms, all methods entail operations on graphs, which in one way or another, represent kinematic chains.

There exist different methods for kinematic synthesis of planar chains with simple joints (Tischler et al., 1995; Belfiore, 2000; Rao & Deshmukh, 2001): intuition and inspection (Crossley, 1964), graphs theory (Dobrzanskyi and Freudenstein, 1967; Woo, 1967). Others consist in transformation of binary chains (Mruthyunjaya, 1979; Mruthyunjaya, 1984-a; Mruthyunjaya, 1984-b; Mruthyunjaya, 1984-c), in the concept of Assur groups (Manolescu et al., 1987; Manolescu, 1964; Manolescu, 1979; Manolescu, 1987), or Franke's notation (Davies & Crossley, 1966; Crossley, 1966). Recently, new methods based on genetic algorithms or neuronal networks are also used (Tejomurtula & Kak, 1999; Abo-Hamour et al., 2002; Cabrera et al., 2002; Laribi et al., 2004).

The analysis of existing methods shows that there are several methods applied to the development of a mathematical model concerning its application for the control design of the robot. However, concerning the topological description of the chains and robots, only Roth-Piper's method (Roth, 1976; Pieper & Roth, 1969) tends towards mechanism description with a view to classify robots.

Generally speaking, the problem of synthesis of mechanism falls into three sub problems:

- specification of the problem: topological and functional specifications and constraints imposed by the environment,
- topological synthesis of the mechanism: enumeration and evaluation of possible topologies,
- dimensional synthesis: choice of dimensions of the mechanism for the selected types of morphologies.

This chapter relates in particular to the second sub problem. Its *principal goal* is to present an overview concerning the chronology of the design of an industrial robot kinematic chain. The chapter starts with a brief reminder of the theory of Modular Structural Groups (MSG), and of the *connectivity* and *mobility* laws of MMT presented in § 2. Afterwards, a new method for structural synthesis of planar link chains in robotics is presented in § 3. It is based on the notion of *logical equations*. Various levels of abstraction are studied concerning the complexity of the structure. This permits the synthesis of planar chains with various degrees of complexity expressed by the number of links, joints and the

degree of mobility. The logical equations allow the association of MSGs of type A and closed chains of type G. The rules for associations of groups are also presented. The aim is to execute all the possible combinations to *join* or *transform* links in order to obtain as many structures as possible by avoiding those which are isomorphic. The association of two groups allows the elaboration of different closed chains of upper level. However there are some defective structures, which do not respect the connectivity and mobility laws. Therefore great care has been taken to avoid them. The problem of degenerated structures is central in their synthesis. It especially concerns chains with two and more degrees of mobility. The problem of *defect*, *degeneration* and *isomorphism* is then approached. Later, a method for description of chains by *contours* and *molecules* is proposed in § 4. It enables to reduce the number of the topological structures of the robots concerning its frame and end-effector position by comparing their respective molecules. This method is then applied in § 5 to describe the structures thus obtained (by logical equations approach) and the topology of the *principal structure* of the industrial robots in the initial phase of their design. Finally a classification of industrial robot structures by different levels of complexity is presented in § 6.

2. Topology of a linked mechanical structure, definitions, terminologies and restrictions

The Manipulation System (MS) of the robot is a mechanism composed of links (elements) joined by kinematic joints often with one degree of mobility (rotary or prismatic joints). These elements are considered as rigid bodies which form a kinematic chain, plane or spatial, which can be open or closed. The type of a kinematic link noted "j" is given by the number of joints enabling its association with other links (Erdman & Sandor, 1991). There are links of "binary", "ternary", "quaternary" ... "polynary" type with $j=1,2,3,\dots$, following from the fact that the link contains 1,2,3,... kinematic joints :



link	binary	ternary	quaternary	...
representation				...
notation	N_2	N_3	N_4	...

Table 1. Planar link types

MMT proposes various ways of representing kinematic structures. The most common, the *kinematic graph*, consists in conserving a shape for the links in or-

der to better appraise the topology of the structure. Nevertheless this presentation is difficult to manipulate. Any kinematic structure may be transformed into Crossley's *inverse graph* (Crossley, 1964) replacing every link (binary, ternary...) by a point. Lines linking the points concerned represent the joints themselves.

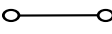
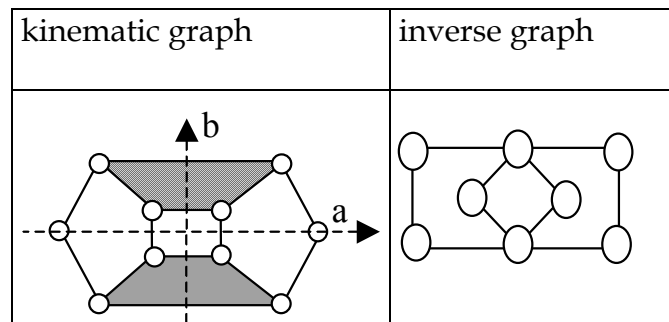

Figure 1. Representation of a structure by kinematic and Crossley's inverse graph

Kinematic *chain* (named Grübler chain in MMT) is a structure which "floats" in space and all its links have identical status. If a frame and an input link (links) is (are) indicated the chain becomes a *mechanism*. The possible motions in a chain are called *degree of freedom* (or absolute degree of mobility) whereas for a mechanism they are called *degree of mobility* (or relative degree of mobility) of N-link Grübler chain.

As it has been said, the arm of a robot or the MS is a mechanism composed of a set of rigid links, which form an open or closed kinematic chain. Existing robots may be topologically classified in two categories according to whether their structure is open or closed:

- robots with simple (open) structure: one can traverse all the kinematic joints by making an open chain. They are noted $A_{i,j}$ where i and j are respectively the degree of mobility and the number of links of the structure (cf. § 3.1).
- robots with complex (arborescent or closed) structure: one can traverse all the kinematic joints by making a closed loop. They are noted $G_{k,l}$ where k and l are respectively the degree of mobility and the number of links of the structure (cf. § 3.1).

Another method allows them to be classified mechanically as robots with planar or spatial chains.

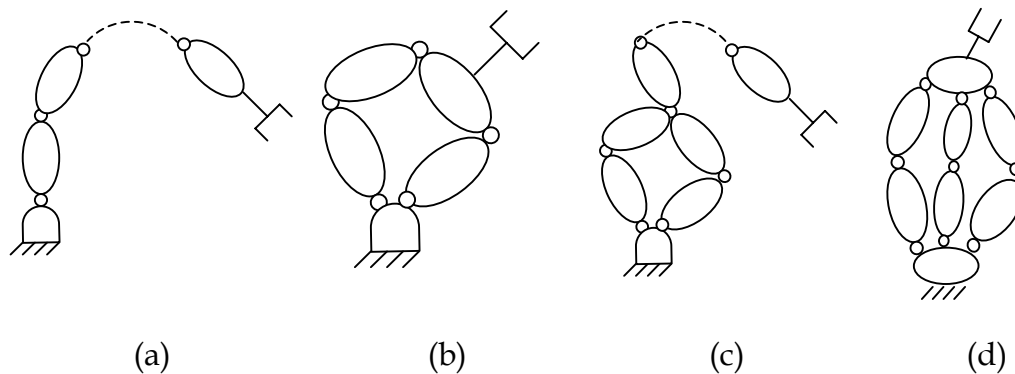

Figure 2. Robots with: simple-open (a), closed (b), arborescent (c) and complex structures (d)

Robots, being complex mechanical systems with an important interaction between their links, their architecture is defined by (Mitrouchev, 1999):

- the *main structure* which generates the main motion of the robot and upon which is situated the rest of the MS,
- the *regional structure* which is composed of the arm and of the forearm (mechanical arm),
- the *local structure* which is the wrist of the robot often with three degrees of freedom in rotation.

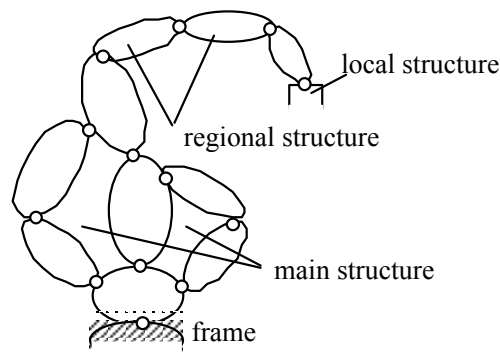

Figure 3. Topological structure of a robot

The number M of degrees of mobility of an isostatic chain relative to a fixed frame is given by Somov-Malisev's formula (Artobolevski, 1977):

$$M = 6N^* - \sum_{k=1}^5 kC_k \quad (1)$$

with: C_k - number of simple joints of class "k",
 N^* - number of mobile links (in general $N^* = N - 1$).

If the kinematic chain only contains simple rotary joints of class 5 (one degree of freedom joint), instead of equation (1), the Tchebychev-Grübler equation is used:

$$M = 3N^* - 2C_5 \tag{2}$$

with: C_5 - number of simple rotary joints with one degree of mobility.

In this chapter only planar structures with simple rotary joints of class 5 shall be considered. If the value of M in Tchebychev-Grübler's equation (2) is $M=0$ it becomes:

$$3N^* = 2C_5 \tag{3}$$

Some of the most characteristic MSGs (called Assur groups) resulting from equation (3) are presented in Table 2 by their kinematic graphs or structural diagrams (Manolescu, 1964).

notation	N^*	C_5	Assur groups	derivative groups
$A_{0,2}$	2	3	
$A_{0,4}$	4	6		
$A_{0,6}$	6	9		
...

Table 2. Modular Structural Groups (MSGs) with zero degree of mobility

If the value of M in Tchebychev-Grübler's equation (2) is $M=1$ it becomes:

$$3N^* - 1 = 2C_5 \tag{4}$$

Some of its solutions are presented in table 3.

notation	N*	C ₅	kinematic graphe (structural diagram)
A _{1,3}	3	4	
A _{1,5}	5	7	
...

Table 3. SMGs with one degree of mobility

Finally for the MSGs adding two degrees of mobility to the structures ($M=2$), one obtains:

$$3N^* - 2 = 2C_5 \quad (5)$$

Some of its solutions are presented in table 4:

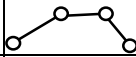
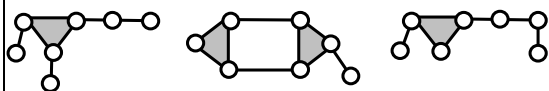
notation	N*	C ₅	structural diagram
A _{2,4}	4	5	
A _{2,6}	6	8	
...	

Table 4. MSGs with two degrees of mobility

3. Proposed method and results

Let us consider a plane kinematic structure comprising N links and C_5 kinematic joints in open, arborescent or closed chain. The first link S_1 is the presumed fixed frame of the robot. MMT, being part of the technological sciences, is at the base of mechanism design in robotics as has been previously mentioned. The question is: for a given degree of mobility and for a given number of links and joints, how many possibilities are there to join them in a mechanism suitable for application in kinematic chain design in robotics? The answer to this question is presented in this paragraph and in the following one. In order to answer the question above, let us consider a mechanism with a given degree of mobility (M). Gauhmann's generalised law (called *connectivity law*) giving the relationship between the number of the links and the joints is (Manolescu, 1987):

$$C_5 = I + N \quad (6)$$

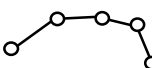
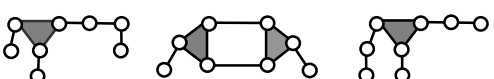
with: $I=R-2$ -structural number representing the complexity level of the structure,

R - number of closed loops in the chain allowing to "read" (to pass through) twice each kinematic joint.

For the planar kinematic structures the *general law of mobility* giving the relationship between the number of degrees of mobility and the joints is:

$$C_5 = M + 3I + 3 \quad (7)$$

The equations (6) and (7) give:

$$N = M + 2I + 3 \quad (8)$$

Those two latter equations (7 and 8) lead to the *first manner* of calculating the number of joints C_5 and the number of links N for planar kinematic structures with different degrees of relative mobility M . The *general law of mobility* giving the relationship between the number of degrees of mobility and the joints is (Manolescu, 1987):

$$M + (1 + I)H = \sum_{k=f+1}^5 (6 - k)C_k \quad (9)$$

with: - $H=(6-F)$,
- F the number of imposed constraints in a chain.

For a planar kinematic structures, $F=3$ hence $H=3$. Equation (9) becomes:

$$M + 3(1 + I) = C_5 + 2C_4 \quad (10)$$

This latter equation allows the *second manner* of calculating the number of links and joints for planar kinematic structures with different degrees of mobility.

3.1 Logical equation

3.1.1 Notations

We note by:

- $A_{i,j}$ a MSG (Assur group or its derivative) which may be open or closed. There are always some exterior (free) joints which only become active when the group is in connection with a joint shared with a chain or a mechanism (Manolescu, 1964),
- $G_{k,l}$ a closed group (structure) without exterior joints.

The first mark represents the degree of mobility of the group and the second one represents the number of its links (cf. Table 5).

groupes	structural diagram	joints	
		exterior	interior
$A_{i,j}$		1,4,6	2,3,5
		1,4	2,3,5,6
$G_{k,l}$		interior only	

Table 5. Structural diagram and types of joints

A *logical equation* is defined as the association (combination) of two initial terms (marks in lower case letters). The result of this association is a final closed kinematic structure of type $G_{M,N}$ (marks in capital letters) of upper level. The two initial terms may be (Mitrouchev, 2001):

$$1. \quad \text{Two identical MSG groups, for example:} \quad A_{i,j} + A_{i,j} = G_{M,N}$$

with: $M=2i+1;$ for $M=1$ and $I=0,2$
for $M=3$ and $I=0$
 $N=2j.$

2. Two different MSG groups, for example: $A_{i,j} + A_{i',j'} = G_{M,N}$

with: $M=i+i'+1;$ for $M=1,$ and $I=1,2,3$
 for $M=2,$ and $I=0$
 $N=j+j'$.

3. One MSG group and one closed group of type $G_{k,l}$: $A_{i,j} + G_{k,l} = G_{M,N}$

with: $M=i+k;$ for $M=1,$ and $I=1,2,3$
 for $M=2,3$ and $I=1,2$
 $N=j+l$

It can be noted that the association of two closed structures is not possible.

3.1.2 Rules for associations

The association of two groups may be done by two operations: direct *junction* and *transformation* of links. They may be executed separately or together. The aim is to use all possible combinations to join or transform the links in order to obtain as many structures as possible (for given N and C_5) by avoiding those, which are isomorphic. Some examples are shown in the Table 6:

<p>by direct junction</p>	
<p>by transformation of links:</p> <ul style="list-style-type: none"> - the binary link 1 becomes ternary - the ternary link 1 becomes quaternary - the binary link 1 becomes quaternary and so on 	

Table 6. Rules for associations of groups

3.2 Generation of chains with one relative degree of mobility (M=1)

For M=1 the equations (7) and (8) give:

$$C_5 = 4 + 3I \quad (11)$$

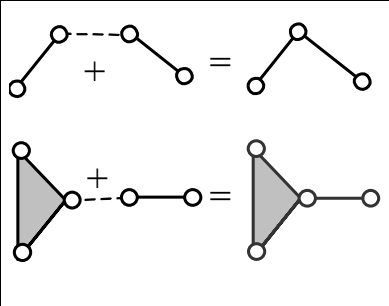
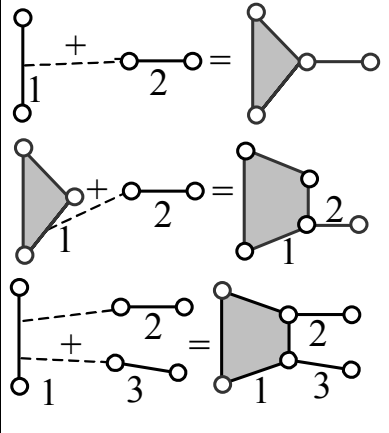
and

$$N = 4 + 2I \quad (12)$$

3.2.1 First level of abstraction, (I=0)

For I=0, equations (11) and (12) give $C_5=4$ and $N=4$. Therefore only one closed planar structure of type $G_{1,4}$ can be synthesised from the following logical equation:

$$A_{0,2} + A_{0,2} = G_{1,4} \quad (13)$$

as follows:

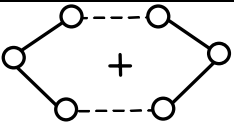
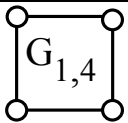
logical equation	schematic	closed structure
$A_{0,2} + A_{0,2} = G_{1,4}$		

The equation (6) gives $C_5=N$. For $C_5=N=4$ there is a mono-contour mobile structure called a group of type G4. For M=1, the equation (10) gives:

$$C_5 + 2C_4 = 4 \quad (14)$$

The possible solutions of this equation are: a) $C_4=0$, $C_5=4$, b) $C_4=1$, $C_5=2$ and c) $C_4=2$, $C_5=0$.

From the solution a) only one closed planar structure of type G4 and noted $G_{1,4}$ can be synthesised by the logical equation (13) above.

3.2.2 Second level of abstraction, (I=1)

For I=1, equations (11) and (12) give $C_5=7$ and $N=6$. The law for generation a group of elementary modules allows the calculation of the number of links, which are ternary and more (quaternary, quintary and so on) in a closed chain (Manolescu et al, 1972).

$$2I = \sum_{j=3}^R (j-2)N_j \quad (15)$$

For $I=1$ equation (15) gives $N_3=2$. From equation (10) one deduces:

$$7 = C_5 + 2C_4 \quad (16)$$

The possible solutions of this equation are: a) $C_4=0, C_5=7$; b) $C_4=1, C_5=5$; c) $C_4=2, C_5=3$ and d) $C_4=3, C_5=1$. The number of the links is calculated by equation (6). It becomes:

$$N = C_5 - I = 6 \quad (17)$$

Consequently the number of binary links is:

$$N_2 = N - N_3 \quad (18)$$

The second level planar structures, of type $G_{1,6}$ are obtained from the following logical equations:

$$G_{1,4} + A_{0,2} = G_{1,6} \quad (19)$$

$$A_{0,4} + A_{0,2} = G_{1,6} \quad (20)$$

Both equations (19) and (20) give two solutions: Watt's and Stephenson's structures. These latter are described by their kinematic graphs (structural diagram) in table 7.

logical equation	groups	method for association	structural diagram
$G_{1,4} + A_{0,2} = G_{1,6}$		by transformation of links	 <p>Watt</p>
			 <p>Stephenson</p>
$A_{0,4} + A_{0,2} = G_{1,6}$		by junction and transformation of links	
		by junction and transformation of links	
		by junction	

Table 7. Watt's and Stephenson's structures

It may be noted that there are three isomorphic structures, which restrict their number to two. Watt's and Stephenson's structures are generated from *closed immobile structure* composed of two ternary links by adding to it four binary links as presented in figure 4.

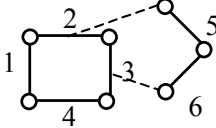
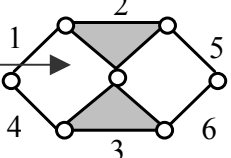
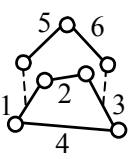
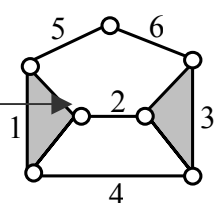
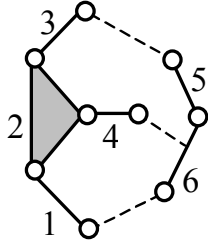
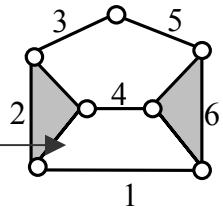
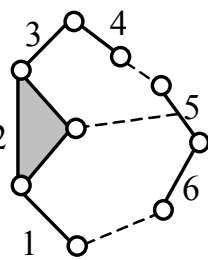
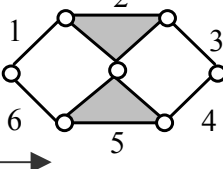
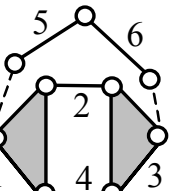
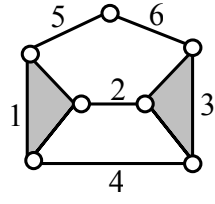
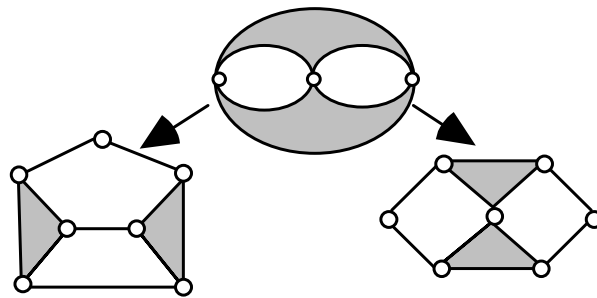

Figure 4. Closed immobile structure (collapse) and its derivatives

The closed immobile structures have no degree of mobility. These are hyperstatic systems, thus they are invariant concerning the mobility parameter. The theory of closed structures is applied just as much in robotics as in civil engineering, concerning bridges and roadways, seismic structures etc. They are equally applicable for planar structures as for spatial ones.

3.2.3 Third level of abstraction, (I=2)

According to expressions (11) and (12) for I=2 one obtains $C_5=10$ and $N=8$ in other words the structure has 8 links and 10 joints. According to equation (15) the number of links is:

$$N_3 + 2N_4 = 4 \tag{21}$$

The possible solutions of this equation and the associated closed structures are given in table 8:

solution	a) $N_3=4, N_4=0$	b) $N_3=2, N_4=1$	c) $N_3=0, N_4=2$
associated closed structure			

Table 8. Third level closed structures

For the case of planar structure, the number of the binary links is:

$$N_2 = N_0 + \sum_{j=4}^{R=I+2} (j-3)N_j \quad (22)$$

where $N_0=M+H$ is the number of links in the main Crossley's chain ($N_0=1+3=4$) hence:

$$N_2 = 4 + \sum_{j=4}^R (j-3)N_j \quad (23)$$

For $I=0$ and $I=1$ the equation (23) has no physical meaning. For $j \leq 3$, the number of binary links is $N_2=4$, so to have a mobile mechanism one needs four binary links, hence for $j=4$:

$$N_2 = 4 + N_4 \quad (24)$$

The possible solutions of this equation are: a) $N_2=4$, $N_4=0$, b) $N_2=5$, $N_4=1$, c) $N_2=6$, $N_4=2$ and d) $N_2=7$, $N_4=3$. The three solutions of (24) which respect the solutions of (21) are a), b) and c).

The third level planar structures of type $G_{1,8}$ are obtained from the following logical equations:

$$G_{1,6} + A_{0,2} = G_{1,8} \quad (25)$$

$$G_{1,4} + A_{0,4} = G_{1,8} \quad (26)$$

$$A_{0,4} + A_{0,4} = G_{1,8} \quad (27)$$

$$A_{0,2} + A_{0,6} = G_{1,8} \quad (28)$$

Equation (25) gives 12 structures; equation (26) gives two structures and a double (isomorphic); equation (27) gives one structure, one defect and one double. Finally, equation (28) gives one structure and two doubles. Table 14 (cf. § 4.) recapitulates the sixteen structures solutions of these four logical equations.

3.2.4 Problem of defect, degeneration and isomorphism

The problem of degenerated structures is central in synthesis of structures. It does not concern the chains with one degree of mobility ($M=1$). But if the chains have two, three or more degrees of mobility there are two degenerate forms of chains called *partial* and *fractionated* mobilities (Manolescu, 1964). If any link of the chain is selected to be the frame of a mechanism and if one chooses any M members to be the independent driving links (called "motor" links), then the position of every remaining member is dependent on the position of all links, such a mechanism is said to have a *total degree of mobility* (Davies & Crossley, 1966). This is the case of structures: 2 of Table 11, and 2, 3, 4 and 6 of Table 12. A mechanism may possess a *partial degree of mobility* if it cannot fulfil the conditions of total degree of mobility mechanism. In all or some of the derived mechanisms, the movement of certain of the driven links depends on the movements of only a number M_p of the motor links, where $M_p < M$ (Manolescu, 1964). This is the case of structures: 1 and 3 of Table 11, and 1, of Table 12. Finally, a mechanism has a *fractionated degree of mobility* if it does not satisfy the conditions for a total degree of mobility. Such a mechanism possesses at least one link (with at least four joints), which may be decomposed into two or more parts, with the result that each sub-mechanism forms a closed chain. The mobility of the whole mechanism is equal to the sum of the mobilities of all sub-mechanisms (Davies & Crossley, 1966). This is the case of structures 4 of table 11; and 5 of table 12.

The rules for association of two groups allow the elaboration of different closed chains. But there are some defect structures, which do not respect the connectivity and mobility laws. Therefore great care has been taken to avoid them. For instance a defect structure is the one among the three solutions of the logical equation (27) shown in Table 9.

logical equation	groups	method for association	structural diagram
$A_{0,4} + A_{0,4} = G_{1,8}$		by junction	

Table 9. Defect structure

By junction of the six binary links, which is the simplest way, the resulting structure is a defect because it has $I=9-8=1$ and $M=21-18=3$. Nevertheless the

structural number I is equal to 2 and the degree of mobility M is equal to 1. Finally there are some isomorphic structures too. Consequently the defect structures and the isomorphic ones are systematically moved away from the possible solutions.

3.2.5 Fourth level of abstraction, $I=3$

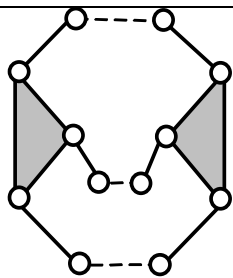
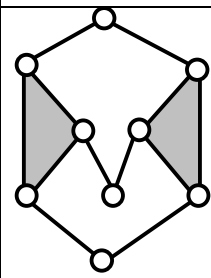
According to expressions (11) and (12) for $I=3$, one obtains: $C_5=13$ and $N=10$. The number of links, which are ternary or greater, is calculated from equation (15). It becomes:

$$6 = N_3 + 2N_4 + 3N_5 \quad (29)$$

The possible solutions of this equation and their associated closed structures are given in the table 10:

solution	a) $N_3=6, N_4=0, N_5=0$	b) $N_3=4, N_4=1, N_5=0$	c) $N_3=2, N_4=2, N_5=0$	d) $N_3=3, N_4=0, N_5=1$
associated closed structure				
solution	e) $N_3=0, N_4=3, N_5=0$	f) $N_3=1, N_4=1, N_5=1$	g) $N_3=0, N_4=0, N_5=2$	
associated closed structure				

Table 10. Fourth level closed structures

The number of binary or greater links is calculated by equation (23):

$$N_2 = 4 + N_4 + 2N_5 \quad (30)$$

The possible solutions of this equation are:

a) $N_2=4, N_4=0, N_5=0$, b) $N_2=5, N_4=1, N_5=0$, c) $N_2=6, N_4=2, N_5=3$, d) $N_2=6, N_4=0, N_5=1$, e) $N_2=7, N_4=3, N_5=0$, f) $N_2=7, N_4=1, N_5=1$, g) $N_2=8, N_4=0, N_5=2$ and h) $N_2=8, N_4=4, N_5=0$.

The solutions of (30), which respect the solutions of (29), are a), b), c), d), e) f) and g). Thus the fourth level planar structures of type $G_{1,10}$ are obtained from the following logical equations:

$$G_{1,8} + A_{0,2} = G_{1,10} \quad (31)$$

$$G_{1,6} + A_{0,4} = G_{1,10} \quad (32)$$

$$G_{1,4} + A_{0,6} = G_{1,10} \quad (33)$$

$$A_{0,2} + A_{0,8} = G_{1,10} \quad (34)$$

$$A_{0,6} + A_{0,4} = G_{1,10} \quad (35)$$

Equation (31) gives 50 structures, (32) gives 95 structures, (33) gives 57 structures, (34) gives 18 structures and (35) gives 10 structures. In total 230 structures obtained also by Woo (Woo, 1967) using the graph theory.

3.3 Generation of chains with two relative degrees of mobility (M=2)



For M=2 the equations (7) and (8) give:

$$C_5 = 5 + 3I \quad (36)$$

And

$$N = 5 + 2I \quad (37)$$

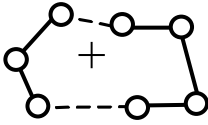
For I=0 the solutions of equations (36) and (37) are $C_5=5$ and $N=5$. The only kinematic structure of type $G_{2,5}$ is provided by the following schematic:

logical equation	Schematic	closed structure
$A_{0,2} + A_{1,3} = G_{2,5}$		

For I=1, the expressions (36) and (37) give $C_5=8$ and $N=7$. The four second level planar structures, of type $G_{2,7}$ are shown in table 11:

$G_{2,5} + A_{0,2} = G_{2,7}$		$G_{1,4} + A_{1,3} = G_{2,7}$	
 <p>partial</p>	1	 <p>partial</p>	3
 <p>total</p>	2	 <p>fractionated</p>	4

Table 11. Planar structures of type $G_{2,7}$

For $I=2$, the solutions of equations (36) and (37) are respectively $C_5=11$ and $N=9$. The third level planar structures, of type $G_{2,9}$ are obtained from the following logical equations:

$$G_{2,7} + A_{0,2} = G_{2,9} \tag{38}$$

$$G_{2,5} + A_{0,4} = G_{2,9} \tag{39}$$

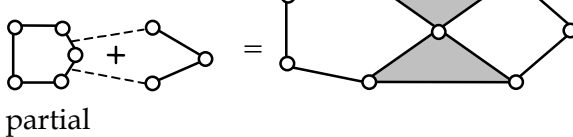
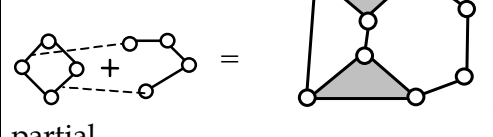
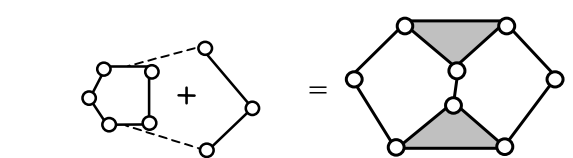
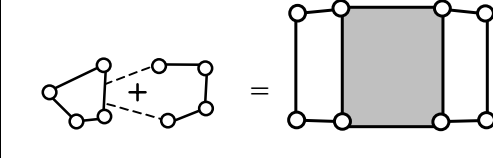
$$G_{1,6} + A_{1,3} = G_{2,9} \tag{40}$$

$$G_{1,4} + A_{1,5} = G_{2,9} \tag{41}$$

The forty structures produced by these four equations were also obtained by Manolescu (Manolescu, 1964) using the method of Assur groups.

3.4 Generation of chains with three relative degrees of mobility, ($M=3$)

For $M=3$ the equations (7) and (8) give: $C_5 = 6 + 3I$ and $N = 6 + 2I$. For $I=0$ one obtains $C_5=6$ and $N=6$. The only kinematic structure of type $G_{3,6}$ is provided by the following schematic:

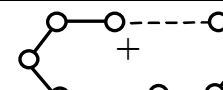
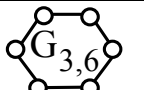
logical equation	Schematic	closed struct.
$A_{1,3} + A_{1,3} = G_{3,6}$		 <p>$G_{3,6}$</p>

For $I=1$, one obtains $C_5=9$ and $N=8$. The six second level planar structures, of type $G_{3,8}$ are presented in Table 12:

$G_{3,6} + A_{0,2} = G_{3,8}$		$G_{2,5} + A_{1,3} = G_{3,8}$	
1 partial		4	
2 total		5	
3 total		6	
		Total	

Table 12. Planar structures of type $G_{3,8}$.

One can notice that there are two isomorphic structures 2 and 6 that restrict their number to five.

For $I=2$, one obtains $C_5=12$ and $N=10$. The third level planar structures, of type $G_{3,10}$ are obtained from the following logical equations:

$$G_{3,8} + A_{0,2} = G_{3,10} \quad (42)$$

$$G_{3,6} + A_{0,4} = G_{3,10} \quad (43)$$

$$G_{2,7} + A_{1,3} = G_{3,10} \quad (44)$$

$$G_{2,5} + A_{1,5} = G_{3,10} \quad (45)$$

$$G_{1,6} + A_{2,4} = G_{3,10} \quad (46)$$

$$G_{1,4} + A_{2,6} = G_{3,10} \quad (47)$$

The ninety-seven structures produced from these six relations were also obtained by T.S. Mruthyunjaya (Mruthyunjaya, 1984-a; Mruthyunjaya, 1984-b; Mruthyunjaya, 1984-c) using the method of transformation of binary chains. These mechanisms with three degrees of mobility are often present in the design of industrial robots.

4. Description of planar structures

Apart from the obvious manner to describe a structure by its *kinematic graph*, the following two ways to describe the planar structures thus obtained are proposed.

1. By *contours*: a contour is defined by a closed loop allowing one to pass through the kinematic joints belonging to it. Two kinds of contours are distinguished: *internal* and *external*.
 - An internal contour is defined by a closed loop allowing one to travel through the kinematic joints belonging to the interior of a structure. A single circle represents it and is noted by a lower case Greek letter.
 - An external contour is defined by a closed loop allowing one to travel through the kinematic joints belonging to the exterior of a structure. A double circle represents it and is noted by a capital Greek letter.



contour				
notation	a	β	γ	δ	ϵ	...
C_5	4	5	6	7	8	...

Table 13. Notation of contours

2. By molecules: A molecule is constituted by contours linked by kinematic joints of class 5. This latter is represented by a line.

Let us remember that in the molecules proposed by Davies and Crossley, based on Franke's notation (Davies & Crossley, 1966), a circle is used to represent a polygonal link (ternary, quaternary etc) and a line to represent a band joining the polygonal links either by a kinematic joint of class 5 or by one or more binary links in a chain. Whereas in the proposed method a circle represents a contour and a line only a kinematic joint of class 5.

For example in Watt's structure α is an internal contour, Γ an external one with $N=6$, $C_5=7$, $I=1$ and $R=3$.

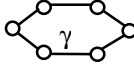
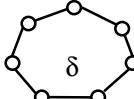

structure	Contours	notation	molecule
	Internal (α) External (Γ) $a - a - \Gamma$	 	

Table 14. Watt's structure and its associated molecule

Table 15 represents the sixteen structures, with one degree of mobility, obtained by logical equations method presented in § 3.2.3. Their contours and molecules are also shown.

structure	kinematic graph	contour	molecule
G_{1-8}^1		$a-a-a-E$	
G_{1-8}^2		$\beta-a-a-\Delta$	
G_{1-8}^3		$\gamma-a-a-\Gamma$	
G_{1-8}^4		$a-a-\beta-\Delta$	
G_{1-8}^5		$a-a-a-E$	
G_{1-8}^6		$a-a-\gamma-\Gamma$	
G_{1-8}^7		$\beta-\beta-\beta-B$	
G_{1-8}^8		$\beta-a-\beta-\Gamma$	
G_{1-8}^9		$\beta-a-\beta-\Gamma$	

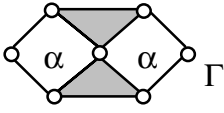
G_{1-8}^{10}		$a - \beta - a - \Delta$	
G_{1-8}^{11}		$a - \beta - \beta - \Gamma$	
G_{1-8}^{12}		$a - \beta - a - \Delta$	
G_{1-8}^{13}		$\beta - a - \beta - \Gamma$	
G_{1-8}^{14}		$a - \gamma - a - \Gamma$	
G_{1-8}^{15}		$a - \gamma - a - \Gamma$	
G_{1-8}^{16}		$\beta - \beta - \beta - B$	

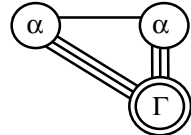
Table 15. Closed structures of type $G_{1,8}$ and their molecules (cf. § 3.2.3)

(Note: 1, 2, ..., 16: arbitrary number of the structure)

5. Application in the description of the main structure of industrial robots

The presented method for mechanisms' description is applied for the description and classification of the main structures of industrial robots with different degrees of mobility.

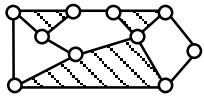
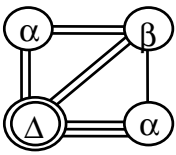
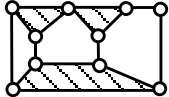
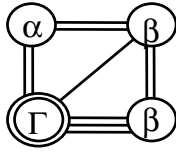
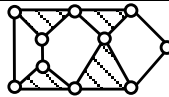
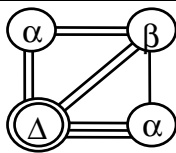
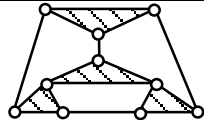
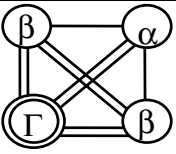
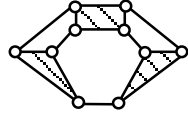
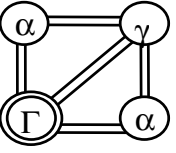
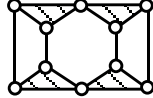
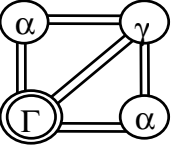
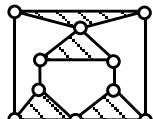
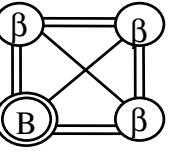
5.1 Robots with open kinematic structures

The simplest structures applied in robotic design are the open loop simple chain. In this case the definitions of contours and molecules have no physical sense. Such a structure is shown in figure 5.



kinematic graph	contour	molecule	mechanism	robot
	non valid	non valid		
legend:  frame				

Figure 5. Staübli robot

For example STAÜBLI RX90L industrial robot (average carrier) has a simple (open) kinematic chain. With a capacity of 6 kg and operating range of 1185 mm it is used in different industrial fields like painting, handling, serving of machine tools etc. (source: [http:// www.staubli.com/ web/web_fr /robot/division.nsf](http://www.staubli.com/web/web_fr/robot/division.nsf)).

5.2 Robots with closed kinematic structures

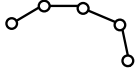
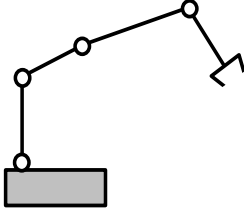
5.2.1 Robot with a main structure having one degree of mobility and $I=0$

For $M=1$ and $I=0$, the most simple structure is the four-links mechanism (cf. § 3.2.1). This structure has only one closed loop to which correspond two identical contours α and A . To one of its links an end-effector is attached, allowing it to manipulate objects. The result of this operation is the mechanism corresponding to the main structure of the level 1 Pick and Place industrial robot. The structure is shown in figure 6:



kinematic graph	contour	molecule	mechanism	robot
	$a - A$			

Figure 6. Pick and Place robot

This is the simplest robot with closed structure. Its task consists in moving light parts from one place to another, which explains its name "Pick and Place". This robot is essentially used in clock and pharmaceutical industries.

5.2.2 Robot with a main structure having two degrees of mobility and $I=0$

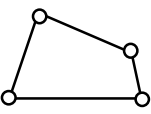
For $M=2$ and $I=0$, there is only one possible kinematic chain obtained by the schematic of § 3.3. The main structure's kinematic graph of this robot is shown in figure 7. In order for the robot to be able to manipulate objects, this planar structure is connected to a frame by transforming one of its binary links to a ternary one (the choice is arbitrary). Finally an end-effector is added by the same process. The result of these operations is the mechanism corresponding to the main structure of the level 1 HPR Hitachi industrial robot.

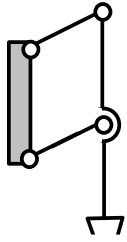
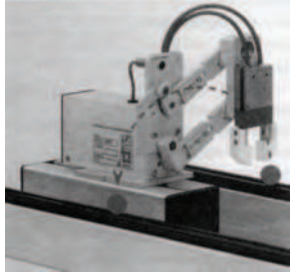



kinematic graph	contour	molecule	mechanism	robot
	$\beta - B$			

Figure 7. HPR Hitachi robot

(source: <http://www.hprd.hitachi.co.jp/merl/robot/robot1.cfm>)

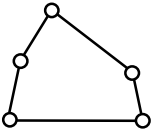
5.2.3 Robot with a main structure having two degrees of mobility and $I=1$

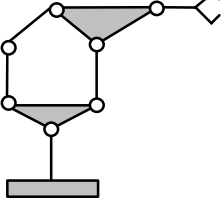
In this case there are many possible structures generated from the four structures of table 11, according to the choice of frame position. Let us consider solution number one of the first column (c.f. table 11, § 3.3). In the same process carried out previously, by linking this structure to a frame and adding an end-effector to it, a structure is obtained corresponding to the *main structure* (cf. fig. 3) of the level 2 AKR-3000 robot. Being able to manipulate a weight up to 15 daN, this robot is essentially used for paintwork.

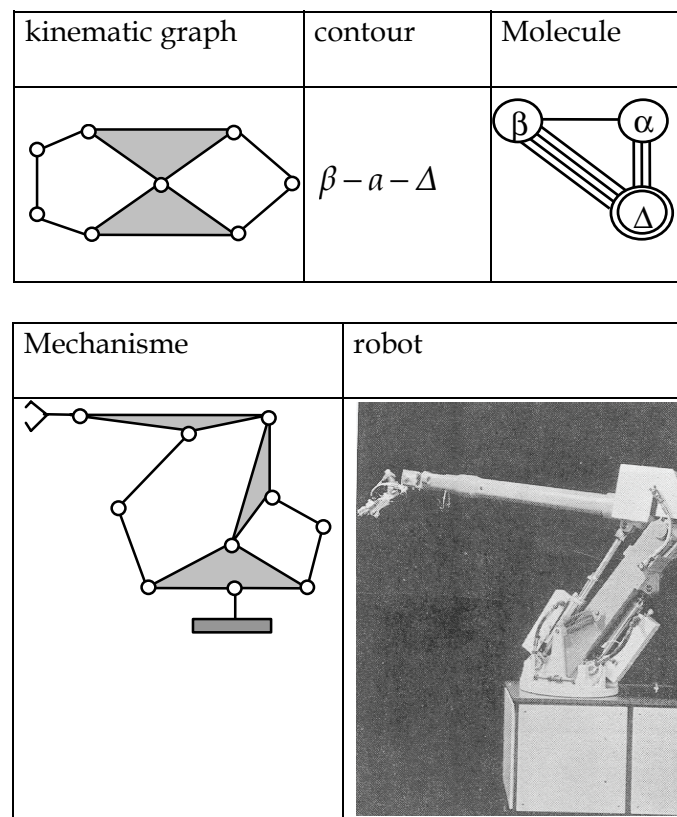

Figure 8. AKR-3000 Robot

5.2.4 Robot with a main structure having one degree of mobility and $I=2$

For $M=1$ and $I=2$ there are many possible structures (c.f. Table 15). Structure $G_{1,8}^{10}$ has been chosen here. By linking this structure to a frame and adding an end-effector to it, a structure is obtained corresponding to the main level 3 structure of the Mitsubishi AS50VS Robot presented in Fig. 9.



kinematic graph	contour	molecule
	$a - \beta - a - \Delta$	
mechanism	robot	
		

Figure 9. Mitsubishi Electric robot

5.2.5 Robot with a main structure having two degrees of mobility and $l=2$

The starting point for generating of the kinematic structure is the first logical equation of Table 7 (Watt's structure). For the desired robot, the $G_{1,6}$ structure thus obtained lacks one degree of mobility and five links. The following operations allow its completion (cf. fig. 10). Adding to this structure a frame and an end-effector the resulting mechanism of this operation corresponds to the main structure of the level 4 HPR Andromat robot.

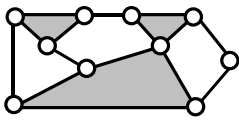
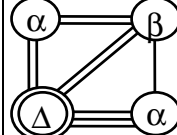
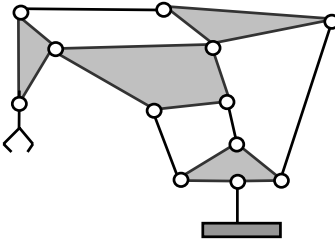
stage/ logical equation	kinematic graph	contour	molecule
first: addition of three links and one degree of mobility $G_{1,6} + A_{1,3} = G_{2,9}$		$\gamma - a - a - E$	
second: addition of two links $G_{2,9} + A_{0,2} = G_{2,11}$	 adopted solution	$a - \gamma - a - \gamma - E$	

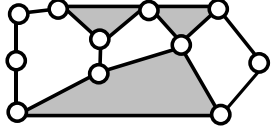
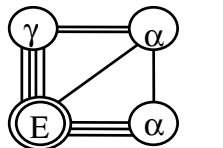
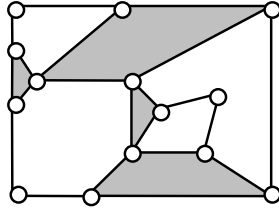
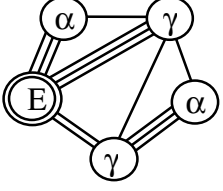
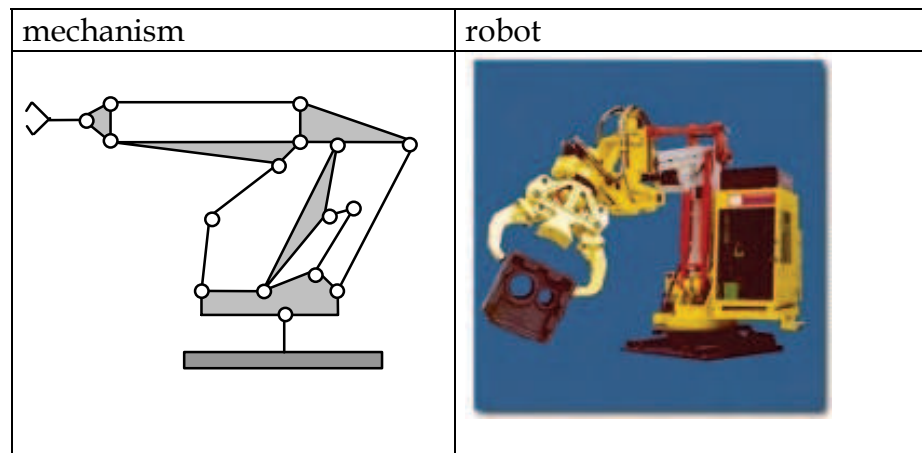

Figure 10. Evolution of the generation of the Andromat robot topological chain (source: http://arbejdsmiljoweb.dk/upload/rap_1_doc.doc)

Among the one hundred and ten available structures of type $G_{2,11}$, a robot manufacturer has implemented the required solution above in order to design the main structure of the Andromat robot. According to the rules defined in § 3.1.2. the frame, initially a quaternary link, was transformed into a quintarny one and the binary link, where the end-effector was attached, into a ternary one.

This robot is equipped with a pantographic system with a working range of 2,5 m and weight range from 250 kg up to 2000 kg. The Andromat is a world-renowned manipulator, which is widely and successfully used in foundry and forging industries enabling operators to lift and manipulate heavy and awkward components in hostile and dangerous environments. (source: <http://www.pearsonpanke.co.uk/>).



During the initial design of the MS of robots, the validation of their topological structures may be done by studying the kinematic graphs of their main structures. The representation by molecules mainly yields to the usual structural diagram of the mechanism in order to visualise and simplify. This allows the classification of their structures and their assignation to different classes of structures, taking into account of their complexity expressed by the number of closed loops. Those points are the subject of the next paragraph.

6. Classification of industrial robots structures

The structures of robots with *simple kinematic chains* may be represented by one open kinematic structures of type A. We call these open structures 0 (zero) level structures. Many industrial robots are of the same type for example: MA 23 Arm, SCARA carrier, AID-5V, Seiko 700, Versatran Vertical 80, Puma 500, Kawasaki Js-2, Toshiba SR-854HSP and Yamaha robots (Ferreti, 1981; Rob-Aut, 1996).

The main structures of robots with *closed kinematic chains* may be represented by closed kinematic chains of type G derived from MMT. The Pick and Place robot, for instance, has only one closed chain. This is a level 1 (one) robot (cf. § 5.2.1). There are other industrial robots of the same level for example: Tokico, Pana-Robo by Panasonic, SK 16 and SK 120 by Yaskawa, SC 35 Nachi etc (Rob-Aut, 1996).

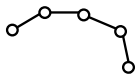
The main structure of the AKR-3000 robot is composed of two closed loops represented by two internal contours in its molecule. This is a level 2 (two) robot. The main structure of Moise-Pelecudi robot (Manolescu et al, 1987) is composed of three closed chains defining a level 3 (three) robot. The main structure of the Andromat robot is composed of four closed chains. This is a level 4 (four) robot etc. Hence the level n of a robot is defined by the number n of internal contours in its molecule. Table 16 completes this classification of certain robots presented by Ferreti in (Ferreti, 1981):

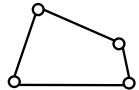
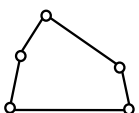
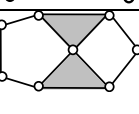
robot	manufacturer	main structure of the robot	contour	nb. of internal contours	level
Nordson	Nordson France		- (simple chain)	0	zero
Robomatic	Binks Manufacturing Co.			0	zero
Cincinnati T3, HT3	Cincinnati		$\alpha - A$	1	one
HPR- Hita- chi	Milacron Fran- ce		$\beta - B$	1	one
RASN	AOIP Kremlin, Robotique AKR		$\beta - a - \Delta$	2	two

AS50VS	Mitsubishi Electric/ Japan		$a - \beta - a - \Delta$	3	three
Andromat	.../Sweden		$a - \gamma - a - \gamma$	4	four

Table 16. Levels of different industrial robots

7. Conclusions and Future Plans

In this chapter we presented an overview about the chronology of design process of an industrial robot kinematic chain. The method for symbolical synthesis of planar link mechanisms in robotics presented here allows the generation of plane mechanical structures with different degrees of mobility. Based on the notion of *logical equations*, this enables the same structures obtained using different methods to be found (intuitive methods, Assur's groups, transformation of binary chains etc).

The goal being to represent the complexity of the topological structure of an industrial robot, a new method for description of mechanisms was proposed. It is based on the notions of *contours* and *molecules*. Its advantage, during the initial phase of the design of the robots, is that the validation of their topological structures can be done by comparing their respective molecules. That makes it possible to reduce their number by eliminating those which are isomorphic.

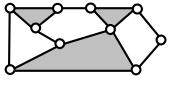
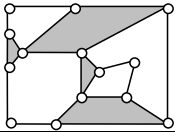
The proposed method is afterwards applied for the description of closed structures derived from MMT for different degrees of mobility. It is then applied to the description and to the classification of the *main structures* of different industrial robots. The proposed method permits the simplification of the visualisation of their topological structures. Finally a classification of industrial robots of different levels taking into account the number of closed loops in their molecules is presented.

In addition to the geometrical, kinematical and dynamic performances, the design of a mechanical system supposes to take into account, the constraints of the kinematic chain according to the:

- position of the frame,
- position of the end-effector,
- and position of the actuators.

The two first aspects above are currently the subjects of our research. The problem is how to choose among the possible structures provided by MMT ac-

according to the position of the frame and the end-effector. As there may be a large number of these mechanisms, it is usually difficult to make a choice among the available structures in the initial design phase of the robot chain. In fact, taking into account the symmetries it can be noticed that there are a significant number of isomorphic structures according to the position of the frame and of the end-effector of the robot. Our future objectives are:

- to find planar mechanisms with revolute joints that provide guidance of a moving frame, e.g. the end-effector of an industrial robot, relative to a base frame with a given degree of freedom,
- to reduce the number of kinematic structures provided by MMT, which are suitable for robotics applications, taking into account the symmetries the two criteria being the position of the frame and of the end-effector of the robot.

8. References

- Abo-Hammour, Z.S.; Mirza, N.M.; Mirza, S.A. & Arif, M. (2002). Cartesian path generation of robot manipulators continuous genetic algorithms, *Robotics and autonomous systems*. Dec 31, 41 (4), pp.179-223.
- Artobolevski, I. (1977). *Théorie des mécanismes*, Mir, Moscou.
- Belfiore, N.P. (2000). Distributed databases for the development of mechanisms topology, *Mechanism and Machine Theory* Vol. 35, pp. 1727-1744.
- Borel, P. (1979). *Modèle de comportement des manipulateurs. Application à l'analyse de leurs performances et à leur commande automatique*, PhD Thesis, Montpellier.
- Cabrera, J.A.; Simon, A. & Prado, M. (2002). Optimal synthesis of mechanisms with genetic algorithms, *Mechanism and Machine Theory*, Vol. 37, pp. 1165-1177.
- Coiffet, P. (1992). *La robotique. Principes et applications*, Hermès, Paris.
- Crossley, F. R. E. (1964). A contribution to Grubler's theory in the number synthesis of plane mechanisms, *Transactions of the ASME, Journal of Engineering for Industry*, 1-8.
- Crossley, F.R.E. (1966). On an unpublished work of Alt, *Journal of Mechanisms*, 1, 165-170.
- Davies, T. & Crossley, F.R.E. (1966). Structural analysis of plan linkages by Franke's condensed notation, Pergamon Press, *Journal of Mechanisms*, Vol., 1, 171-183.
- Dobranskyi L., Freudenstein F., 1967. Some application of graph theory to the structural analysis of mechanisms, *Transactions of the ASME, Journal of Engineering for Industry*, 153-158.
- Erdman A., Sandor G. N., 1991. *Mechanism Design, Analysis and Synthesis*, Second edition.
- Ferreti, M. (1981). Panorama de 150 manipulateurs et robots industriels, *Le Nouvel Automatisme*, Vol., 26, Novembre-Décembre, 56-77.
- Gonzales-Palacois, M. & Ahjeles J. (1996). USyCaMs : A software Package for the Interactive Synthesis of Cam Mechanisms, *Proc. 1-st Integrated Design and Manufacturing in Mechanical Engineering I.D.M.M.E.'96*, Nantes France, 1, 485-494.
- Hervé L.-M., 1994. The mathematical group structure of the set of displacements, *Mech. and Mach. Theory*, Vol. 29, N° 1, 73-81.
- Hwang, W-M. & Hwang, Y-W. (1992). Computer-aided structural synthesis of plan kinematic chains with simple joints *Mechanism and Machine Theory*, 27, N°2, 189-199.
- Karouia, M. & Hervé, J.M. (2005). Asymmetrical 3-dof spherical parallel mechanisms, *European Journal of Mechanics (A/Solids)*, N°24, pp.47-57.

- Khalil, W. (1976). *Modélisation et commande par ordinateur du manipulateur MA-23. Extension à la conception par ordinateur des manipulateurs*, PhD Thesis. Montpellier.
- Laribi, M.A. ; Mlika, A. ; Romdhane, L. & Zeghloul, S. (2004). A combined genetic algorithm-fuzzy logic method (GA-FL) in mechanisms synthesis, *Mechanism and Machine Theory* 39, pp. 717-735.
- Ma, O. & Angeles, J. (1991). Optimum Architecture Design of Platform Manipulators, *IEEE*, 1130-1135.
- Manolescu, N. (1964). Une méthode unitaire pour la formation des chaînes cinématiques et des mécanismes plans articulés avec différents degrés de liberté et mobilité, *Revue Roumaine Sciances. Techniques- Mécanique Appliquée*, 9, N°6, Bucarest, 1263-1313.
- Manolescu, N. ; Kovacs, F.R. & Oranescu, A. (1972). Teoria Mecanismelor si a masinelor, *Editura didactica si pedagogica*, Bucuresti.
- Manolescu, N (1979). A unified method for the formation of all planar joined kinematic chains and Baranov trusses, *Environment and Planning B*, 6, 447-454.
- Manolescu, N. ; Tudosie, I. ; Balanescu, I. ; Burciu, D. & Ionescu, T. (1987). Structural and Kinematic Synthesis of Planar Kinematic Chain (PKC) and Mechanisms (PM) with Variable Structure During the Work, *Proc. of the 7-th World Congress, The Theory of Machines and Mechanisms*, 1, Sevilla, Spain, 45-48.
- Manolescu N., 1987. Sur la structure des mécanismes en robotique, Conférence à l'Ecole centrale d'Arts et Manufactures, Paris 1987.
- Merlet, J.-P. (1996). Workspace-oriented methodology for designing a parallel manipulator ", Proc. 1-st *Integrated Design and Manufacturing in Mechanical Engineering I.D.M.M.E.'96*, April 15-17, Nantes France, Tome 2, 777-786.
- Mitrouchev, P. & André, P. (1999). Méthode de génération et description de mécanismes cinématiques plans en robotique, *Journal Européen des Systèmes Automatisés*, 33(3), 285-304.
- Mitrouchev, P. (2001). Symbolic structural synthesis and a description method for planar kinematic chains in robotics, *European Journal of Mechanics (A Solids)*, N°20, pp.777-794.
- Mruthyunjaya, T.S. (1979). Structural Synthesis by Transformation of Binary Chains, *Mechanism and Machine Theory*, 14, 221-238.
- Mruthyunjaya, T.S. (1984-a). A computerized methodology for structural synthesis of kinematic chains: Part 1- Formulation, *Mechanism and Machine Theory*, 19, No.6, 487-495.
- Mruthyunjaya, T.S. (1984-b). A computerized methodology for structural synthesis of kinematic chains: Part 2-Application to several fully or partially known cases, *Mechanism and Machine Theory*, 19, No.6, 497-505.

- Mruthyunjaya, T.S. (1984-c). A computerized methodology for structural synthesis of kinematic chains: Part 3-Application to the new case of 10-link, three-freedom chains, *Mechanism and Machine Theory*, 19, No.6, 507-530.
- Pieper, L. & Roth, B. (1969). The Kinematics of Manipulators Under Computer Control, *Proceedings 2-nd International Congress on The Theory of Machines and Mechanisms*, 2, 159-168.
- Rao, A. C. & Deshmukh, P. B. (2001). Computer aided structural synthesis of planar kinematic chains obviating the test for isomorphism, *Mechanism and Machine Theory* 36, pp. 489-506.
- Renaud, M. (1975). *Contribution à l'étude de la modélisation et de la commande des systèmes mécaniques articulés*, Thèse de Docteur ingénieur. Université Paul Sabatier, Toulouse.
- Rob-Aut. (1996). La robotique au Japon, ROBotisation et AUTomatisation de la production, N°12, Janvier-Février, 28-32.
- Roth, B. (1976). Performance Evaluation of manipulators from a kinematic viewpoint, *Cours de robotique*. 1, IRIA.
- Tejomurtula, S. & Kak, S. (1999). Inverse kinematics in robotics using neural networks, *Information sciences*, 116 (2-4), pp. 147-164.
- Tischler, C. R.; Samuel A. E. & Hunt K. H. (1995). Kinematic chains for robot hands - I. Orderly number-synthesis, *Mechanism and Machine Theory*, 30, No.8, pp. 1193-1215.
- Touron, P. (1984). Modélisation de la dynamique des mécanismes polyarticulés. *Application à la CAO et à la simulation de robots*, Thèse, Université de Montpellier.
- Warneke, H.J. (1977). Research activities and the I.P.A. in the field of robotics, *Proc. of the 7-th ISIR Congress*, Tokyo, 25-35.
- Woo, L. S. (1967). Type synthesis of plan linkages, *Transactions of the ASME, Journal of Engineering for Industry*, 159-172.



Industrial Robotics: Theory, Modelling and Control

Edited by Sam Cubero

ISBN 3-86611-285-8

Hard cover, 964 pages

Publisher Pro Literatur Verlag, Germany / ARS, Austria

Published online 01, December, 2006

Published in print edition December, 2006

This book covers a wide range of topics relating to advanced industrial robotics, sensors and automation technologies. Although being highly technical and complex in nature, the papers presented in this book represent some of the latest cutting edge technologies and advancements in industrial robotics technology. This book covers topics such as networking, properties of manipulators, forward and inverse robot arm kinematics, motion path-planning, machine vision and many other practical topics too numerous to list here. The authors and editor of this book wish to inspire people, especially young ones, to get involved with robotic and mechatronic engineering technology and to develop new and exciting practical applications, perhaps using the ideas and concepts presented herein.

How to reference

In order to correctly reference this scholarly work, feel free to copy and paste the following:

Peter Mitrouchev (2006). Kinematic Design and Description of Industrial Robotic Chains, *Industrial Robotics: Theory, Modelling and Control*, Sam Cubero (Ed.), ISBN: 3-86611-285-8, InTech, Available from: http://www.intechopen.com/books/industrial_robotics_theory_modelling_and_control/kinematic_design_and_description_of_industrial_robotic_chains

INTECH
open science | open minds

InTech Europe

University Campus STeP Ri
Slavka Krautzeka 83/A
51000 Rijeka, Croatia
Phone: +385 (51) 770 447
Fax: +385 (51) 686 166
www.intechopen.com

InTech China

Unit 405, Office Block, Hotel Equatorial Shanghai
No.65, Yan An Road (West), Shanghai, 200040, China
中国上海市延安西路65号上海国际贵都大饭店办公楼405单元
Phone: +86-21-62489820
Fax: +86-21-62489821

© 2006 The Author(s). Licensee IntechOpen. This chapter is distributed under the terms of the [Creative Commons Attribution-NonCommercial-ShareAlike-3.0 License](#), which permits use, distribution and reproduction for non-commercial purposes, provided the original is properly cited and derivative works building on this content are distributed under the same license.