

The Gas Transportation in a Pipeline Network

Jolanta Szoplik
*West Pomeranian University of Technology, Szczecin,
Poland*

1. Introduction

During the last few years we have been able to observe increasing development of different types of networks. Energetic, telecommunication, water or gas networks are only a few examples of systems whose main purpose is media transportation from the source (producer, manufacturer) to the target place of use. One of the basic features of network systems is their uniqueness with regard to the structure as well as transmission capability. In practice there are no two identical networks and their uniqueness leads to the necessity of use of individual approach to networks during designing and exploitation stage. Moreover networks have complex structure and any change or modification of their structure while in use is not an easy task. For these reasons flow improvement in current network and optimal exploitation of its capabilities is an important and actual issue.

In case of many real-time systems, examination of their performance in conditions different from currently existing is impossible. In such a situation a mathematical model of such system is constructed which is a kind of simplification of the reality (Kralik et al., 1988; Osiadacz, 1987 and Osiadacz, 2001). However, the model of the system can be used to simulate its behaviour in reaction on extortion. Simulation is an example of an experiment, performed with the help of an appropriate algorithm and a computer. An enormous advantage of computer simulation is its repeatability, and each simulation task in the same initial conditions can be repeated infinitely many times. In real conditions such an experiment is almost impossible to perform, as from technical point of view, it is extremely difficult to perform direct measurement of some values characterizing work of the system. However, conducting a series of simulations for different initial conditions allows to receive various solutions and to choose the best one out of those received. Such an example of using simulation results can be treated as quasi-optimisation which can be accepted as sufficient when the relations between elements of the system and extortion are not well known. The approach which uses mathematical model is a huge simplification of the real system.

A gas network can be an example of a system, where from the technical point of view, it is difficult to perform direct measurements of parameter values characterising flow in pipeline networks. Currently we observe evident increase in gas consumption by the municipal receivers as well as the industry, and this is the reason why gas transportation network from the place of extraction directly to the recipient results in pipelines system becoming more and more complex. Gas in the network is transported under appropriate pressure. Depending on its level we can distinguish three different types of networks: high, middle or

low pressure networks (Osiaacz, 1987; Kralik et al., 1988). The analysis of network flow simulation results enables us to estimate such network bandwidth reserves, define possibilities of network expansion directions and possibility of connecting new recipients, calculate maximal value of the gas flow rate in the pipeline of the network or gas parameters (e.g. pressure) in output points. Overpressure layout, velocity of the gas and gas flow rate in each pipeline of the given gas network can be defined on the basis of network gas flow simulation.

In the literature, there are many examples of application various mathematical methods and IT tools, to facilitate solving complex simulation tasks, optimisation or steering in regard to gas flow in the gas pipeline or gas pipelines network.

The subject of several scientific papers was the analysis of flow issues and leakage detection in network systems. The authors stated, that these problems can play an important role in the management of pipeline system and to cause reduce the loss of leakage. Gonzalez et al. (2009) focused on modeling and simulation of gas pipeline network and presented two models derived from the set of partial differential equations and two numerical schemes for integration of such models. Fukushima et al. (2000) proposed and successfully implemented the leak detection system based on a dynamic simulation with wave equation using real operational data on their one of the longest gas pipeline in Japan. Brkić (2009) for construction and calculation of looped gas distribution pipeline network of composite structure with known node gas consumption proposed to use an improvement of Hardy Cross method procedure. Liu et al. (2005) presented an adaptive particle filter to tackle the leak detection and location in gas pipelines. Reddy et al. (2006) used dynamic simulation models (transfer function model) of gas pipeline network for on-line leak detection and identification and they stated, that proposed method was 25 times faster than the explicit finite - difference approach.

The problems of heat exchange between gas flowing through the pipe and the ground analysed Osiaacz & Chaczykowski (2001), Chaczykowski (2010), Ke & Ti (2000), Tao & Ti (1988). Ke & Ti, 2000 and Tao & Ti, 1988 proposed for transient analysis of isothermal gas flow in the pipeline network a new mathematical model based on electrical analogy. These papers treated mainly of gas flow in high pressure network that have much simpler structure than low pressure networks.

However, applying in the research Artificial Neuronal Network (ANN), does not require earlier knowledge of exact relations between particular values, and it is only sufficient to know input and output data. Examples of use of Artificial Neuronal Networks for modelling, steering or optimisation of fluid flow or transport supporting appliances can be found in literature. Zahedi et al. (2009) propose applying the ANN method to predict hydrates forming temperature during gas transportation with gas pipeline. According to the authors results received using the ANN are more adequate than analogous results received with traditional methods. Carvalho et al. (2006) applied the ANN to detect and then to classify faults on side of the gas pipeline to appropriate group. The authors proved that precision of the ANN to detect faults on gas pipeline side is approximately 94%, whereas correctness of recognition of fault type (corrosion or other) is approximately 92%. The ability of the ANN to recognise type of corrosion (internal, external) is clearly smaller (approximately 72%). Silva et al. (2007) in their work introduced proposal of applying the

ANN for analysis of influence of pipeline corrosion defects on chosen parameters characterising the flow. The authors however noticed that there is necessity of verification of work effects with real data. Based on the results from magnetic flux leakage signals, Hwang et al. (2000) presented a new approach for training, hierarchical wavelet basis function neural network for the three-dimensional characterization of defects on the pipeline. Nguyen et al. (2006, 2008) use the Neural Network for forecasting the demand of the hourly gas stream for customer. Experimental data obtain by ANN are used in the Genetic Algorithm to search the optimal combination of compressor scheduling.

The purpose of this chapter is to perform the analysis of results of the steady-state simulation calculation for gas flow in the low pressure gas pipelines network, based on which, two methods of steering the gas stream pressure entering the network will be described. Under discussion will be variability of gas consumption from the network by different recipients groups in seasonal and daily cycle. Air temperature will be important parameter with significant influence on gas consumption by consumers. There will be an algorithm developed to steer gas pressure in form of dependence of gas pressure on stream volume feeding the network, as well as the network characteristic with marked network nodes, where the pressure is lowest. It was proved, that steering gas pressure feeding the network, due to keeping lower gas pressure in the network, can significantly lower the network exploitation costs.

In the present chapter fragment of real low pressure network in Szczecin city (Poland) was used and calculations were performed for real data presenting hourly gas streams leaving 108 nodes of the network in successive hours of four chosen days with various air temperature.

2. The elements of gas pipeline network system

Gas network consists of connected and cooperating with each other objects that transport and distribute natural gas. Fig. 1 presents main objects that compose to the gas network and their main classification. Gas pipelines with equipments are used to transfer and distribute gas fuel to consumers. Polish classification of gas pipeline networks and short characteristics (gas overpressure (p), gas speed (w) and type of pipes material) are presented in Fig. 2. Taking into account the gas stream overpressure, there are four types of gas pipelines. Another classification is, when as classification criteria, the type of pipes material in the network. In this case there are gas pipelines made of polyethylene (PE) or steel. Fig. 3 presents all previously mentioned gas network objects.

Gas station is a set of appliances in the gas network fulfilling separate or simultaneous functions of pressure reduction, stream measurement and gas characteristics or stream division. The gas compressor station raises the gas stream pressure in order to overcome the pressure lost resulting from the frictional gas flow in the pipeline of network.

Turbines in compressor stations can be fed with gas from the gas pipeline or electrically. Gas storehouses are natural containers constructed in rock mass, underground mining excavations or salt caverns, and used to storage gas in periods of lower demand (months of high air temperature) and additional network feed during periods of higher gas demand (months of low air temperature).

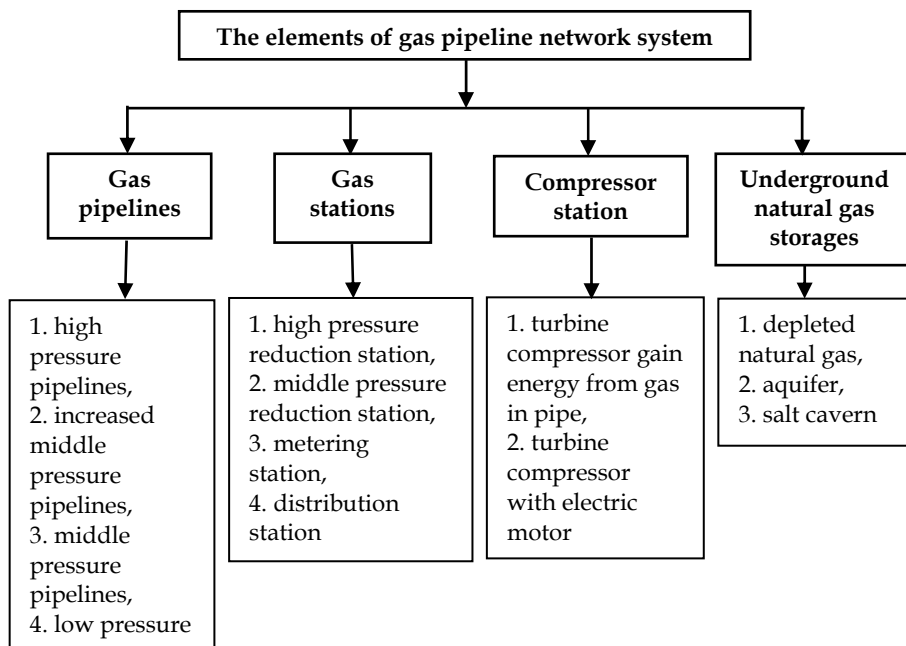

Fig. 1. Technical units composed the gas pipeline network.

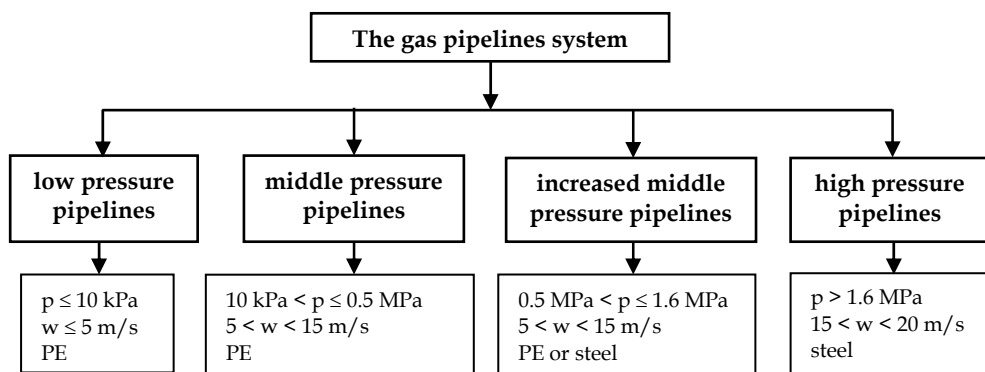

Fig. 2. The main types of gas pipeline networks.

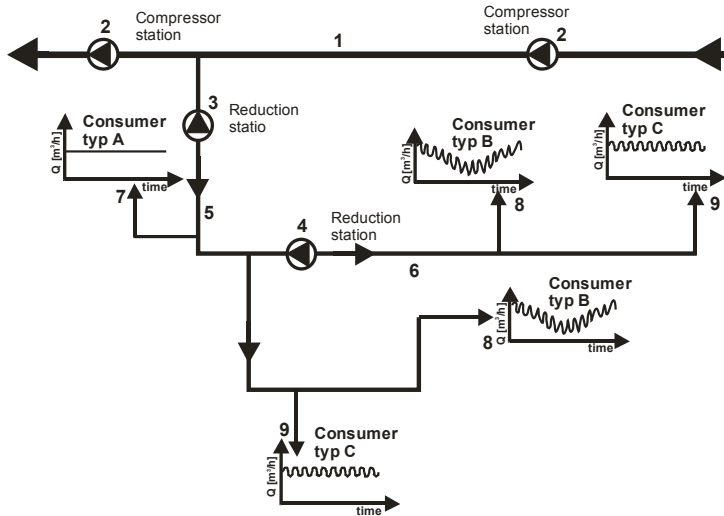

Fig. 3. Fragment of gas network with marked objects and gas use characteristics by different groups of consumer.

Fig. 3 shown that, large amount of natural gas is transported on long distances through the high pressure pipelines network (1). Compressor stations (2) are located on gas pipelines in distance of 100-150 km, that increase initial gas pressure lost during the flow. Whereas natural gas delivered to consumers is characterised with clearly lower overpressure that is received after two stage pressure reduction in reduction stations. High pressure gas reduction station (3) lowers gas pressure from high to medium level. However, in middle pressure gas reduction station (4) is second stage of gas pressure reduction to low level. Gas pipelines network between gas reduction stations (3) and (4) is called (middle pressure gas network) (5), whereas from the gas reduction station (4) distribution of gas with low pressure gas network (6) begins directly to municipal consumers (7), (8), (9).

3. The variety of the gas demand in the year

Natural gas transported with network presented in Fig. 3, is delivered to industrial (7) and municipal (8) and (9) consumers. In the industry the natural gas is used as raw material and main source of methane, whereas in households gas is used to prepare meals and heat water and accommodation. In Fig. 3, three types of gas consumers are marked and presented their gas usage characteristic within a year. The A type (7) is an industrial consumer, who consumes from the network the same gas amount regardless of time of the year and time of the day. The B type (8) and C type (9) are municipal consumers that use gas in households. The B type consumer is characterised with variable gas consumption within daily and seasonal cycle, which means, that gas is mainly used to house heating. The C type consumer uses gas only to prepare meals or possibly to heat water, therefore this kind of variation can be accepted as only daily variation.

Gas consumption by the B type consumers mainly depends on weather and calendar factors. Fig. 4 presents exemplar diagram of gas consumption variation by large group of B and C

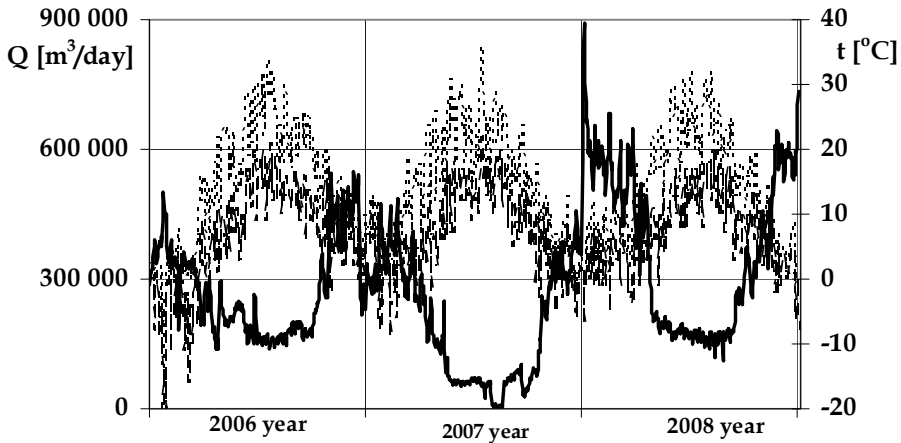

Fig. 4. The change of gas stream Q in days of years 2006, 2007 and 2008; (...) - t_{\max} the day temperature, (-) t_{\min} the night temperature, (—) Q daily volumetric gas flow; (Szoplik J., 2010a).

type consumers together, for one of Polish cities in successive days of years 2006, 2007 and 2008 depending on air temperature. The increase of air temperature during summer months (July, August) influences on visible gas consumption decrease and vice versa, low air temperatures (January, February, November and December) cause, that large gas amounts leave the network and the gas is used mainly to heating. Variation of gas consumption from the network results with various network loads.

4. Mathematical model for gas network

The computer programs used for simulation of gas pipeline distribution transport system are based on the gas network mathematical model. The detailed form of the mathematical model for such a system depends on the assumptions of flow as well as the conditions of the network operation. There is no universal formula to describe the flow of gas in a pipeline. The different equations are used depending on the working pressure of the network and the assumptions made with regard to the conditions of the network operation (Osiaacz, 1987; Osiaacz, 2001; Kralik et al., 1988). Three equations describing the gas flow through a pipeline network are derived from the equation of continuity, the equation of motion and the equation of energy (Osiaacz & Chaczykowski, 2001; Ke & Ti, 2000):

$$\frac{\partial \rho}{\partial t} + \frac{\partial(\rho w)}{\partial x} = 0 \quad (1)$$

$$\frac{\partial(\rho w)}{\partial t} + \frac{\partial(\rho w^2)}{\partial x} + \frac{\partial p}{\partial x} + 2\rho w^2 \left(\frac{\lambda}{D} \right) + g\rho \sin \alpha = 0 \quad (2)$$

$$\frac{\partial}{\partial t} \left[(\rho A dx) \left(c_v T + \frac{w^2}{2} + gz \right) \right] + \frac{\partial}{\partial x} \left[(\rho w A dx) \left(c_v T + \frac{p}{\rho} + \frac{w^2}{2} + gz \right) \right] - q\rho A dx = 0 \quad (3)$$

where: ρ is the density of gas, w is the gas flow velocity, λ is the Finning friction coefficient, D is inner diameter of the pipe, α is the angle between the horizon and the direction x , A is the cross-section area of the pipe, c_v is the specific heat at constant volume, q is the specific heat related per unit mass and T is the temperature of gas.

Stationary gas flow in a pipeline does not vary in time and is a special case of dynamic behaviour of gas flow in a pipeline. In this case, the variables in the equations of continuity, motion and the energy are only a function of coordinates and this system is described by the set of nonlinear algebraic equations (Osiadacz, 1987 and Osiadacz, 2001). For the low-pressure gas pipeline network, when the change of the gas pressure and the dynamics of the flow can be neglected, it is suitable to use the steady-state simulation. The more complex the pipeline network is, the more complex the mathematical model of such system is therefore in order to solve this problem in most cases computers are used. In case of gas networks the structure of the pipeline network can be presented by means of the graph theory, which allows simple representation of the structure in terms of the properties of its elements incidence.

A graph (Kralik et al, 1988; Osiadacz, 1987 and Osiadacz, 2001) consists of a set of nodes and a set of branches. The nodes are presented by points whereas the branches by line segments connecting two points. When a branch has a pair of nodes in a certain order the graph is called direct graph. Sometimes the node is connected to itself and this closed path of nodes and branches is called a loop of the graph. In case of the gas pipeline network the boundary nodes are the points where the elements are connected to the whole network and this is the node that belongs to a single element. The second type of node is an internal node of the network which is common to exactly two elements (simple node) or to at least three elements (crossing node). Gas enters the network at node called supplier node and leaves the network at boundary nodes. A branch in gas pipeline network is a pipe with constant diameter and roughness. Taking into account the position of a branch in the network there are boundary and internal branches.

The interconnection of the pipe in the network can also be presented by the branch-nodal incidence matrix $A = [a_{ij}]_{n \times m}$. The number of rows (n) is equal to the number of nodes, but the number of columns (m) is equal to the number of branches (Osiadacz, 1987; Osiadacz, 2001 and Kralik et al., 1988). Each element a_{ij} of the matrix A is equal to 0 or (+1) or (-1).

$$a_{ij} = \begin{cases} +1 & \text{when branch } (j) \text{ enters node } (i), \\ -1 & \text{when branch } (j) \text{ leaves node } (i), \\ 0 & \text{when branch } (j) \text{ is not connected to node } (i) \end{cases}$$

The incidence of the loops and branches describes the matrix of branch-loop $B = [b_{ij}]_{k \times m}$. The rows (k) in matrix B correspond to the loops while the columns (m) correspond to the branches in the network. The elements b_{ij} are defined as:

$$b_{ij} = \begin{cases} +1 & \text{when branch } (j) \text{ has the same direction as loop } (i), \\ -1 & \text{when branch } (j) \text{ has opposite direction to loop } (i), \\ 0 & \text{when branch } (j) \text{ is not in loop } (i) \end{cases}$$

Osiadacz (1987); Osiadacz (2001) and Kralik et al. (1988) propose that for the simulation of the steady-state pipeline networks the analogy between fluid and electrical network can be successfully applied. The aim of the simulation of the gas flow is to estimate the values of the flow rates in each pipe of the network and the pressure at each node of the network. The calculated value of flow and pressure must satisfy the flow equation and together with the value of the loads and off-takes gas flow must satisfy the first and second Kirchhoff's laws.

The matrix form for the first and second Kirchhoff's law (Osiadacz, 1987; Osiadacz, 2001 and Kralik et al., 1988) represent the following equations:

$$A_1 \cdot Q = q \quad (\text{I Kirchhoff's law}) \quad (4)$$

$$B \cdot \Delta p = 0 \quad (\text{II Kirchhoff's law}) \quad (5)$$

where:

$A_1 = [a_{ij}]_{(n-1) \times m}$	- reduced nodal-branch incidence matrix,
$B = [b_{ij}]_{k \times m}$	- loop-branch incidence matrix,
$Q^T = [Q_1, Q_2, \dots, Q_m]$	- vector of flows in the branches,
$q^T = [q_1, q_2, \dots, q_{(n-1)}]$	- vector of stream at the output nodes,
$\Delta p^T = [\Delta p_1, \Delta p_2, \dots, \Delta p_m]$	- vector of pressure drops in the branches,

Equations (4) and (5) complete with one of the following forms of flow equation (equation 6 or 7) are the matrix form of the mathematical model and describe the gas flow in the network.

$$Q = \Psi(\Delta p) \quad (6)$$

$$\Delta p = \Phi(Q) \quad (7)$$

where: $\psi(\Delta p)$ is the vector of pressure drop functions in the branches and $\phi(Q)$ is the vector of flow functions

There are two methods which are most frequently used to carry out the simulation of the gas flow in the network. In the nodal method, the equations (4, 5 and 6) are resolved. Initial approximations are made to the nodal pressure and are corrected in the next iterations until the final solution is reached. The loop method is the other way to resolve the mathematical model for the gas flow. Initial approximations are made to the branch flow and next iterations are corrected until the final solution is reached. The loop method provides the solution of the equations (4, 5 and 7).

5. The subject of the analysis in the study

The subject of the analysis was the real low pressure pipeline network which consisted of 319 pipelines of various diameters (from 0.050 m to 0.25 m). The whole length of the pipeline in this network was equal to 4151 m and the overall amount of gas accumulated in the network was equal to 51 m³. The low pressure gas pipeline network operated with overpressure in the range of 1.7 kPa to 2.5 kPa. The operating temperature was 283 K, the relative density of the gas was equal to 0.6. The velocity of the gas was always lower than 5 m/s in each pipe of the network.

The graphic representation of the network analysed in the study consisted of 316 nodes and 319 branches (Szoplik J., 2010b, 2010c). Taking into account the position of nodes in the

network is possible to distinguish two types of nodes: boundary and internal nodes. There was 1 supplier node (Fig. 5, point Z1 – gas reduction station), where gas entered the network, 108 nodes, where gas left network (boundary or output nodes) and 207 internal nodes. There were also one input, 108 output and 210 internal branches in the graph of the network.

Boundary branches containing input or output nodes are called input and output branches respectively, but the elements which are neither input nor output elements of the network are called internal elements. The number of loops in this pipeline network was 3. Fig. 5 is the graphic representation of the network used in the study. The detailed data for the graph, diameter and length of each type of the pipe in the network presented in Fig. 5 are collected, respectively, in Table 1 and Table 2. There are only 13 nodes distinctly marked at the graph presented in Fig. 5 (A2; A51; A61, A64, A65, A70, A71, A75, A92, A90, A80, A146, A147). The flow rate at these nodes is divided or the diameter of the pipe is varied.

No	Description	Number
1	Total number of nodes	316
2	- supplier node	1
3	- boundary (output) nodes	108
4	- internal nodes	207
5	Total number of branches	319
6	- output branches	108
7	- internal branches	210
8	Number of loops	3

Table 1. The characteristics of the nodes and branches for the graph presented in Fig. 5.

The mathematical model of gas flow in the pipeline network consisting of equations (4), (5) and (7) was performed with computer program GasNet, used to steady-state simulation of gas flow by means of loop method. Calculations were performed for real fragment of the low pressure gas pipeline network in the city Szczecin and were based on real data characterising hourly values of gas streams which left the network at each of 108 output nodes for different values of gas stream overpressure entering the network in gas reduction station Z1 (Fig. 5). The drop pressure in pipelines constituting network was calculated as a difference of absolute pressure in two adjacent nodes. The friction factor λ was determined according to the guidelines concluded in the norm PN-76/M-34034.

No	D_{nom} [mm]	D_{in} [mm]	s [mm]	L [m]
1	250	204.6	22.7	18.7
2	225	184.0	20.5	687.6
3	180	147.2	16.4	1280.7
4	160	130.8	14.6	80.2
5	125	102.2	11.4	517.1
6	90	73.6	8.2	813.5
7	63	51.4	5.8	735.8
8	50	40.8	4.6	17.8

Table 2. The diameter D , length L and thickness s of the wall for the pipes of the network presented in Fig. 5.

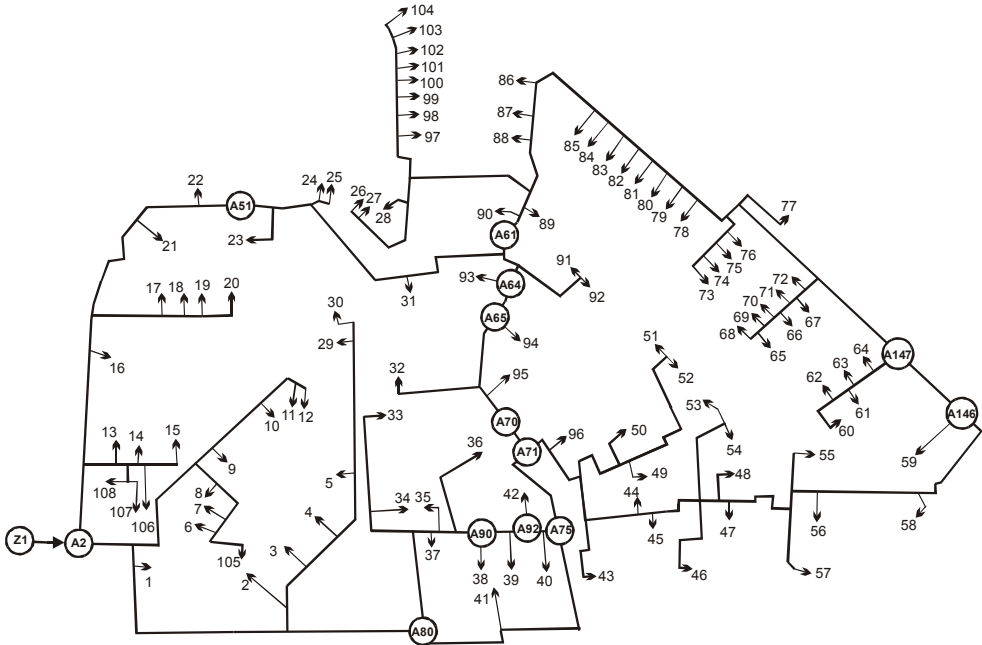

Fig. 5. The graph of the gas pipeline network; Z1 – middle pressure gas reduction station; (Szoplik J., 2010b).

In the case of the low pressure gas pipeline network the drop pressure in each branch was calculated as the difference of the pressure at two adjacent nodes. The friction factor λ in the laminar region ($Re \leq 2300$) is defined by the Hagen-Poiseuille:

$$\lambda = \frac{64\eta}{wD_{in}\rho} = \frac{64}{Re} \tag{8}$$

For the turbulent gas flow the friction factor depends on the Reynolds number as well as the relative roughness of the pipe wall ($e = k/D_{in}$). The friction factor in transitional region ($Re > 4000$ for $e \leq e_{bound}$), depends only on Reynolds number and is described by the implicit relationship Prandtl-Karman:

$$\lambda = \left[2 \log \frac{\sqrt{\lambda} Re}{2.51} \right]^{-2} \tag{9}$$

Colebrook-White equation is used to calculate the friction factor for the flow in fully turbulent region ($Re > 4000$ and $e > e_{bound}$) when factor λ depends also on the Reynolds number and relative roughness e :

$$\lambda = \left[-2 \log \left(\frac{2.51}{Re \sqrt{\lambda}} + \frac{e}{3.72} \right) \right]^{-2} \tag{10}$$

The boundary relative roughness e_{bound} describes one of the relationships below:

- Filonienko-Altsul

$$e_{bound} = \frac{18 \log Re - 16.4}{Re} \quad (11)$$

- Blasius

$$e_{bound} = 17.85 Re^{-0.875} \quad (12)$$

- Altsul-Ljacer

$$e_{bound} = \frac{23}{Re} \quad (13)$$

5.1 The characteristic of input data

Steady-state gas flow simulation calculations are conducted based on properly prepared input data in form of 108 values of hourly gas streams consumed from the network by consumers in consumption nodes.

Amount of daily gas stream leaving particular node of the network depends inter alia on air average temperature. Based on archive data covering years 2006-2008, linear relations of daily gas consumption in function of air average temperature were developed. Details of defining linear models of gas consumption value from the temperature are described in literature (Szoplik J., 2010a). General form of linear model to define daily gas stream Q_d [m³/day] consumed by consumers from particular node is presented by equation

$$Q_d = a(18-t) + b \quad (14)$$

where: a , b – model constant, individually determined for each node of the network based on real data of gas consumption by consumers, t – average air temperature [°C].

Fig. 6. presents results describing gas stream volume variation Q_d received within twenty four hours in four selected nodes of the network from the Fig. 5 depending on average air temperature $t = +18, +8, -4, -16$ °C (set according to equation (14)). Comparing results presented in Fig. 6 one can see, that the increase of daily gas stream Q_d leaving the network, caused by temperature increase, is not equal in all nodes of the network, as the number of gas consumers and gas receivers installed at consumers, consuming gas from a particular node of the network is different.

However amount of hourly gas stream Q [m³/h] leaving particular node of the network is defined based on characteristic of percentage gas consumption in particular hours of the day. Such characteristics were developed based on real data describing gas stream flow through reduction and measurement station in successive hours of the day in various days of the year. Fig. 7 presents gas stream size change during different hours of the day with average temperature of -4 °C in four selected nodes of the network from the Fig. 5. However Fig. 8 presents the results in form of hourly stream size Q of the gas leaving the network in node 55 during various hours of four exemplar days, differ with air temperature.

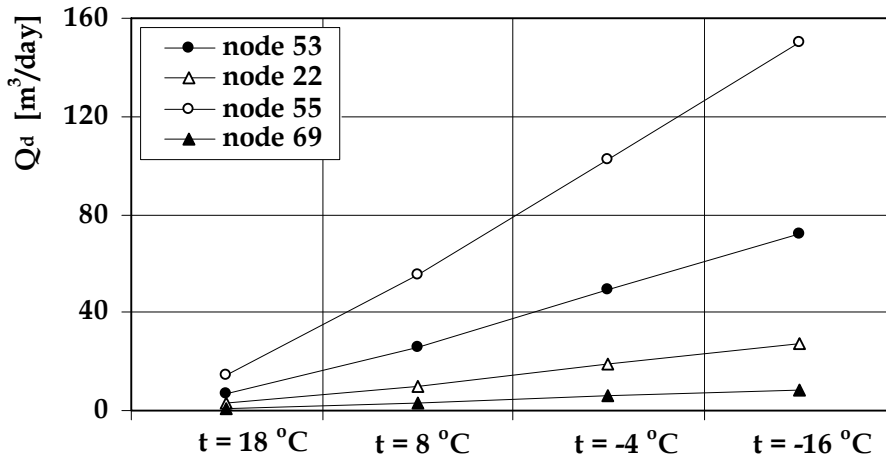

Fig. 6. The effect of air temperature t on the volumetric daily gas stream size Q_d in a given node of the network.

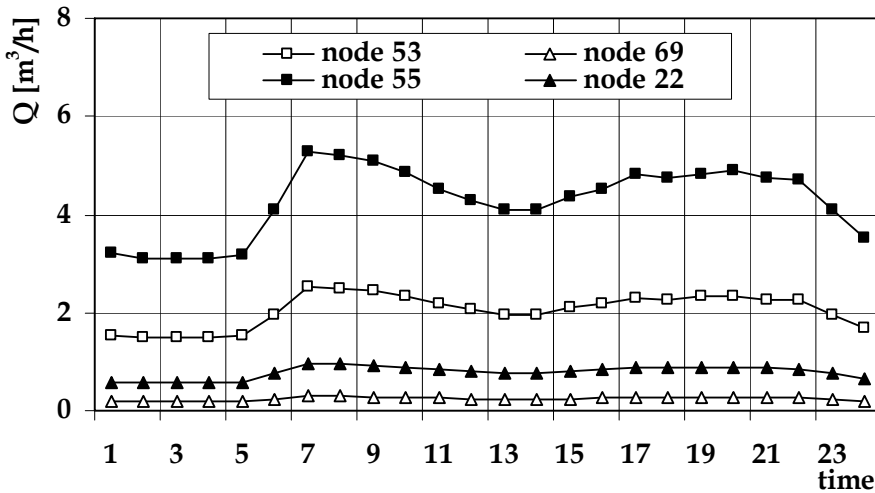

Fig. 7. Change of the gas stream size Q leaving the network in four exemplar nodes of the network in particular hours of the day; air temperature $t = -4$ °C.

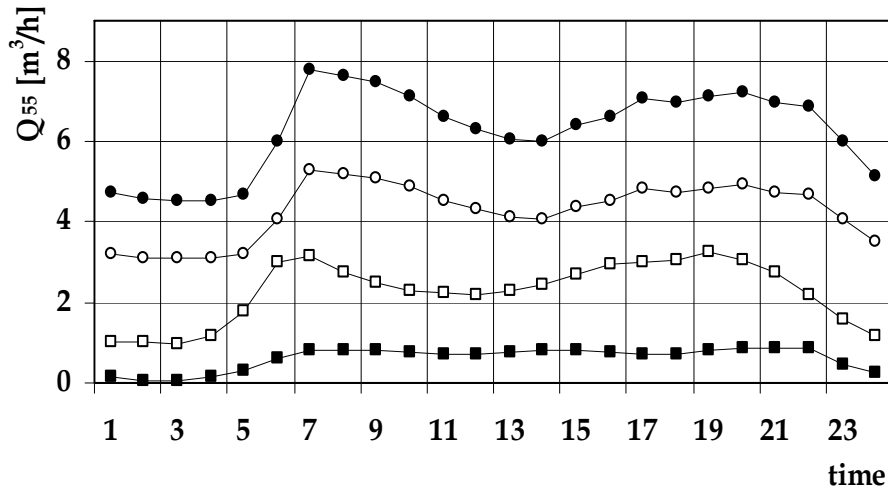

Fig. 8. Change of the gas stream Q_{55} leaving the network in node 55 in particular hours of the day; various values of air temperature; (●) $t = -16\text{ }^{\circ}\text{C}$, (○) $t = -4\text{ }^{\circ}\text{C}$, (□) $t = 8\text{ }^{\circ}\text{C}$, (■) $t \geq 18\text{ }^{\circ}\text{C}$.

Analysing results presented in Fig. 7 and Fig. 8 one can notice, that size of the hourly gas stream Q depend on air temperature and hour of the day and type of the node in the network. It can also be noticed, that in the same node of the network (i.e. node 55) maximal gas stream size Q_{max} noted on the day with average temperature of $-16\text{ }^{\circ}\text{C}$ is nine times larger than that the day with temperature of $18\text{ }^{\circ}\text{C}$. There are also clear differences between maximal and minimal stream values Q during a day (for the same node). In percentage, larger diversity is noticed during summer days than during winter days. During winter time ($t = -16\text{ }^{\circ}\text{C}$) maximal gas stream size Q_{max} is larger than minimal stream Q_{min} by approximately 70%, however it is two times larger for summer time ($t \geq 18\text{ }^{\circ}\text{C}$).

6. The results and discussion

Change of the gas stream leaving the network in 108 nodes during season and twenty four hour cycle is reflected on appropriate diversity of the network load. With the GasNet 3.8.1 programme, a steady-state simulation of gas flow in network, for each set of input data (108 values of gas streams) was conducted. Details of mathematical model of gas flow in the network and algorithm, according to which calculations were performed in the GasNet programme, were described in papers (Szoplik J., 2010b, 2010c). For each of four, exemplar days different with average temperature conducted 24 simulations. In total, performed 96 simulation calculations, are presented in this chapter.

In practice, it is accepted, that the network works correctly, when each collection node gas stream of appropriate size is delivered with pressure higher than $p \geq 1700\text{ Pa}$. Fulfilling above two conditions is possible due to correct work of the reduction gas station (point Z1, Fig. 5). Gas stream overpressure entered into the network through the middle pressure gas reduction station Z1 (Fig. 5) can be variable in range from 1700 to 2500 Pa. From the practical point of view, the overpressure of the gas entered to the network should be

possible lowest, as this will allow to maintain respectively low gas pressure in the network, that in case of leak or the network failure will allow to minimize gas losses. Such effect can be achieved by steering appropriately gas stream pressure feeding the network in point Z1.

Steering gas stream pressure inputted into the network can be done with several methods. One of the methods is to connect pressure of gas stream p_{z1} and stream size Q_{feed} . For that purpose it is necessary to develop relationship $p_{z1} = f(Q_{feed})$. Another method is to make dependent entry stream pressure on gas pressure in selected point of the network. In this case it is necessary to develop gas network characteristic and appointing network nodes, where pressure is the lowest, as those nodes shall be most exposed to possible entry pressure changes.

6.1 Pressure steering algorithm

During gas flow in the network simulation, for each entry data set (gas stream leaving network), overpressure gas stream entered into the network was multiple time changed, and it allowed to indicate (from range of 1700 ÷ 2500 Pa) the lowest gas overpressure feeding the network. During research a clear dependence was noticed of the feeding overpressure stream on the size of the stream entering the network. The stream overpressure p_{z1} dependence on the stream size Q_{feed} , being sum of streams received in 108 nodes of the network is presented on Fig. 9. The figure presents 96 points, that characterise minimal gas overpressure, that at given network load Q_{feed} , ensure gas delivery to all 108 gas consumption nodes under overpressure higher than 1700 Pa. Data on the Fig. 9 presenting results received for each of 24 hours and 4 days of various air temperature were described using the equation

$$p_{z1} = 5 \cdot 10^{-4} Q_{feed}^2 + 8.23 \cdot 10^{-2} Q_{feed} + 1703 \quad (15)$$

Equation (15) allows to estimate the value of minimal gas stream overpressure p_{z1} [Pa] feeding the network depending on size of that stream Q_{feed} [m³/h] with average relative error of ± 2 %. The equation (15) includes influence of both time of the day and air temperature on the size of the stream overpressure feeding the network. Air temperature influences on the decrease of gas streams leaving the network in 108 consumption nodes, and hence there is smaller total gas stream entering the network Q_{feed} . Influence of the time of the day on feeding pressure value is considered also in form of gas stream size leaving the network. Higher gas consumption from the network can be noticed during day hours, whereas lower during night hours. Exact entry overpressure value change p_{z1} in further hours of the exemplar winter day ($t = -16$ or -4 °C), summer day ($t \geq 18$ °C) or autumn or spring day ($t = 8$ °C) presents in Fig. 10. Analysing results presented in Fig. 10 one can see, that value of the stream minimal overpressure feeding the network depends on the time of the day and achieves higher values in hours of maximal gas consumption from the network.

The equation (15) called pressure steering algorithm can be used to program the reducer in gas reduction station (point Z1 on Fig. 5). However, determination of such an algorithm requires many time consuming calculations.

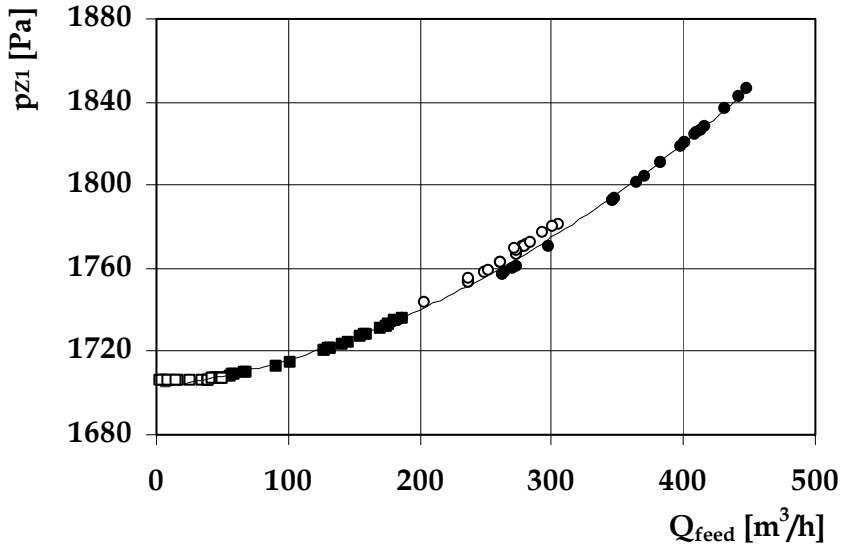

Fig. 9. The effect of gas stream size feeding the network Q_{feed} on the gas stream overpressure p_{z1} ; (●) $t = -16\text{ }^{\circ}\text{C}$, (○) $t = -4\text{ }^{\circ}\text{C}$, (■) $t = 8\text{ }^{\circ}\text{C}$, (□) $t \geq 18\text{ }^{\circ}\text{C}$.

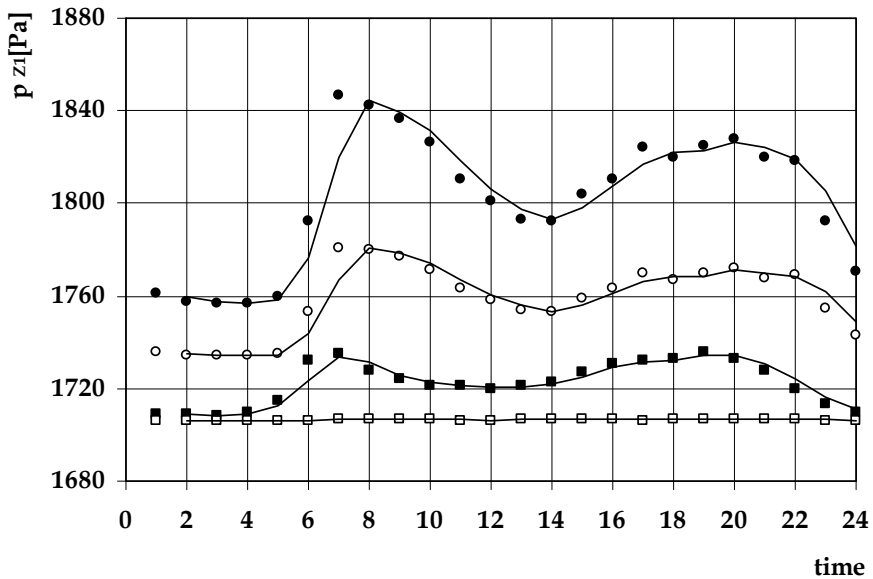

Fig. 10. The change of the gas stream overpressure p_{z1} feeding the network in particular hours of the day; various values of air temperature; (●) $t = -16\text{ }^{\circ}\text{C}$, (○) $t = -4\text{ }^{\circ}\text{C}$, (■) $t = 8\text{ }^{\circ}\text{C}$, (□) $t \geq 18\text{ }^{\circ}\text{C}$.

6.2 The characteristic of gas pipeline network

Based on gas flow in the network steady-state simulation results allowed to define also the network characteristic, that is presented in form of map of overpressure and gas streams layout in all gas pipeline of the network. Analysed data allowed to determine areas of the network, that are most sensitive to possible entry pressure stream fluctuation. Results presented in further part of the chapter were received for minimal value of the network feeding overpressure gas p_{z1} , but allowing to deliver gas to each node of the network under overpressure of $p \geq 1700$ Pa. Therefore on presented maps there are no areas with too low gas pressure. However based on detailed calculation results, received during simulation, one can at the same time define nodes of the network that due to their location in the network and characteristic of gas partition, are sensitive on gas pressure rapid decrease. Such nodes (called typical nodes) were marked on Figs. 11 - 14 with dashed line and their location in the network changes and depend on gas streams leaving the network. The reason of typical nodes location change in the network is irregular location of gas collection nodes, what causes uneven network load. In this case, even small gas pressure decrease at the network entry, below minimal value, will cause that gas streams consumed by the recipients focused in these nodes, will characterise with overpressure lower than minimal accepted ($p = 1700$ Pa), and this may cause damage or faulty running of appliances feeding with gas.

Joining typical node or nodes of the network with gas reduction station (point Z1) can be used in second mentioned gas pressure steering method. Gas pressure drop in typical node will be a signal to the reduction station to increase gas pressure entered to the network and vice versa.

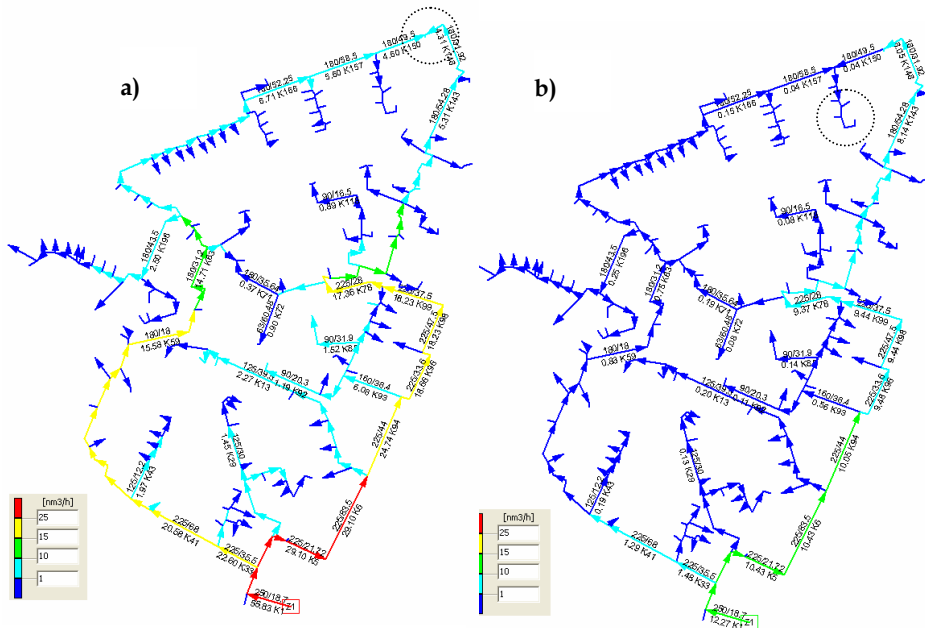

Fig. 11. Gas stream arrangement in pipelines network; $t \geq 18^\circ\text{C}$; a) results for 7 am ($p_{z1} = 1707$ Pa; $Q_{feed} = 55.83$ m³/h); b) results for 3 am ($p_{z1} = 1706$ Pa; $Q_{feed} = 12.27$ m³/h).

The simulation results in form of gas streams layout in the gas pipeline network received for the hour of minimal and maximal gas consumption on the day of average air temperature higher than $t > 18\text{ }^{\circ}\text{C}$ are presented in Fig. 11. However, analogous data, received however for a winter day with average air temperature $t = -4\text{ }^{\circ}\text{C}$ presents Fig. 12. Comparing results presented in Figs. 11 and 12 one can see, that clearly higher load of the network is during winter in hours of top gas consumption (at 7 am), whereas lowest is in summer during night hours (at 3 am). In summer time in definitely larger part of gas pipelines, the stream of flowing gas is lower than $1\text{ m}^3/\text{h}$, whereas in winter is much higher and is approx. $8\text{ m}^3/\text{h}$.

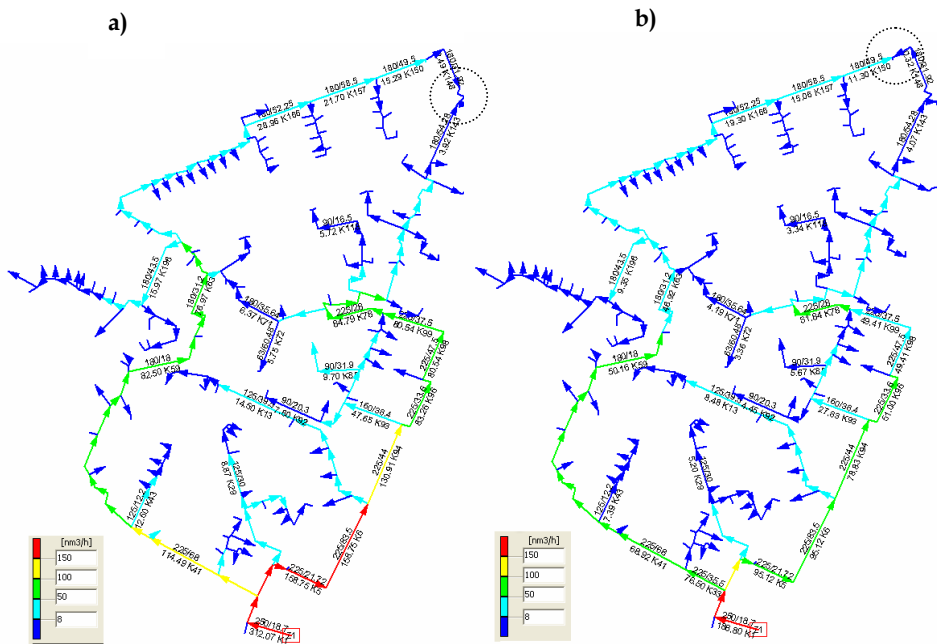

Fig. 12. Gas stream arrangement in pipelines network; $t = -4\text{ }^{\circ}\text{C}$; a) results for 7 am ($p_{z1} = 1781\text{ Pa}$; $Q_{feed} = 312.07\text{ m}^3/\text{h}$); b) results for 3 am ($p_{z1} = 1734\text{ Pa}$; $Q_{feed} = 186.80\text{ m}^3/\text{h}$).

The network load increase caused by higher gas consumption from the network requires its feeding with stream of higher overpressure. Considering results presented on Fig. 13 and Fig. 14 gas overpressure layout can be analysed in all the network gas pipelines depending on the network load and feeding overpressure value. No significant differences were noticed in the overpressure values feeding the network in summer time (Fig. 13a and Fig. 13b). However in winter time (Fig. 14a and Fig. 14b) differences between gas overpressure values entered the network within hours of top consumption and during the night hours are clearly higher.

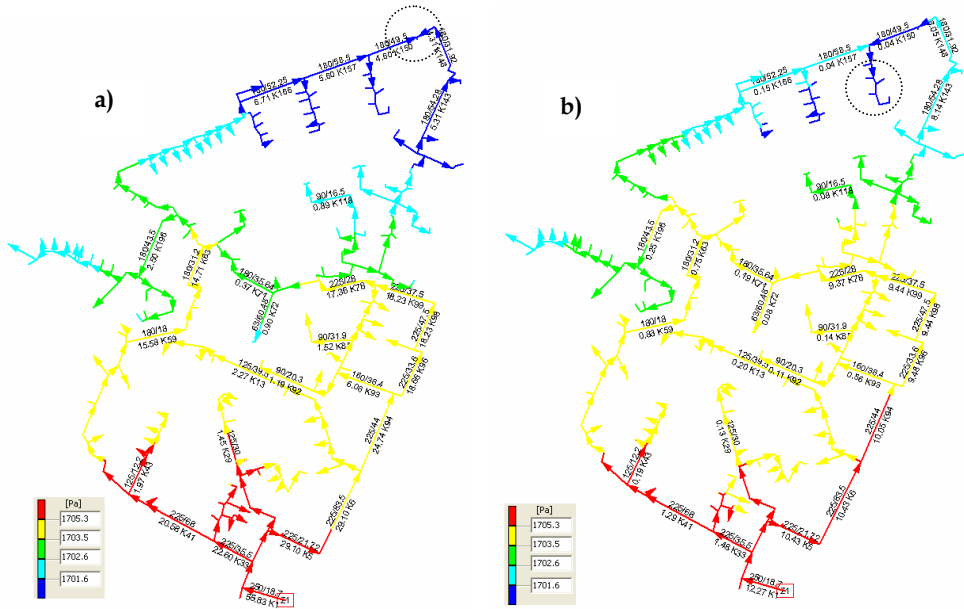

Fig. 13. Gas stream overpressure arrangement in pipelines network; $t \geq 18 \text{ }^\circ\text{C}$; a) results for 7 am ($p_{z1} = 1707 \text{ Pa}$; $Q_{feed} = 55.83 \text{ m}^3/\text{h}$); b) results for 3 am ($p_{z1} = 1706 \text{ Pa}$; $Q_{feed} = 12.27 \text{ m}^3/\text{h}$).

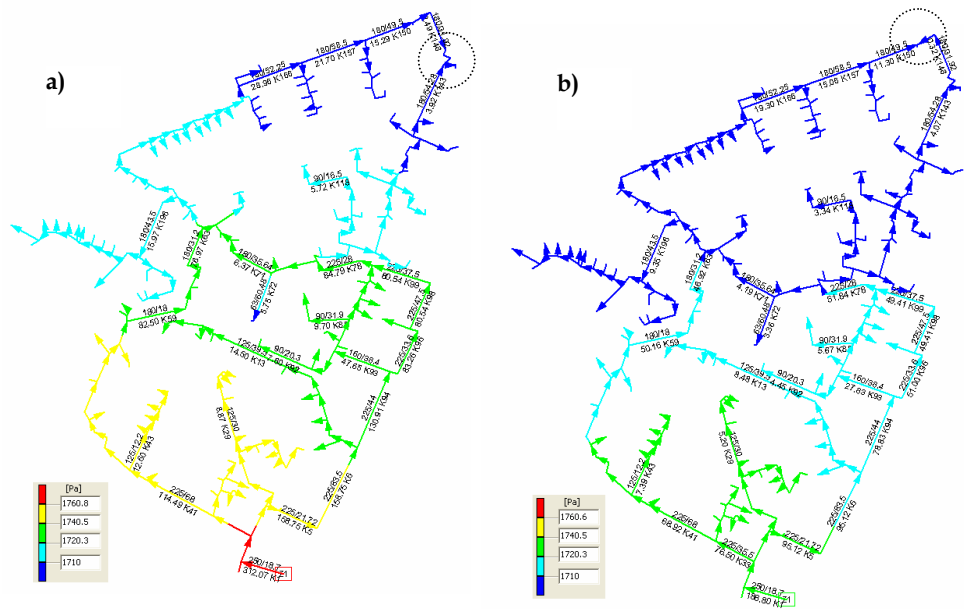

Fig. 14. Gas stream overpressure arrangement in pipelines network; $t = -4 \text{ }^\circ\text{C}$; a) results for 7 am ($p_{z1} = 1781 \text{ Pa}$; $Q_{feed} = 312.07 \text{ m}^3/\text{h}$); b) results for 3 am ($p_{z1} = 1734 \text{ Pa}$; $Q_{feed} = 186.80 \text{ m}^3/\text{h}$).

7. Conclusions

Natural gas transportation and distribution from production place is in gas pipelines that vary with gas overpressure value, gas speed in pipe, network pipeline materials and the network structure.

Gas transportation to consumers is a difficult task, because characteristic feature of gas flow in the network is irregularity of the network load caused with irregularity of gas consumption by consumers from the network, that shift in seasonal and daily cycle.

Gas transportation through network depends inter alia on the work quality of the gas network objects (compressor stations, reduction stations and gas pipelines). Large number of works dedicated to work optimisation of objects proves importance of this issue.

Assuming, that gas loss resulting from the network leak are proportional to gas pressure in the pipeline, steering gas pressure feeding the network allows to lower significantly the network exploitation costs due to lower gas loss, caused with the network leak or with the network gas pipeline damage.

8. Acknowledgment

The author would like to thank to the President and workers of the Gas Company in Szczecin, for access and preparation of data to necessary for preparation of the present work and for providing precious guidelines, enabling correct interpretation of the calculation results.

9. References

- Brkić D. (2009). An improvement of Hardy Cross method on looped spatial natural gas distribution networks. *Applied Energy*, 86, pp. 1290-1300.
- Carvalho A.A., Rebello J.M.A., Sagrilo L.V.S., Camerini C.S. & Miranda I.V.J. (2006). MFL signals and artificial neural networks applied to detection and classification of pipe weld defects. *NDT&E international*, 39, pp. 661-667.
- Chaczykowski M. (2010). Transient flow in natural gas pipeline - The effect of pipeline thermal model. *Applied Mathematical Modelling*, 34, pp. 1051-1067.
- Fukushima K., Maeshima R., Kinoshita A., Shiraishi H. & Koshijima I. (2000). Gas pipeline leak detection system using the online simulation method. *Computers & Chemical Engineering*, 24, pp. 453-456.
- Herran-Gonzalez A., De La Cruz J.M., De Andres-Toro B., Risco-Martin J.L. (2009). Modeling and simulation of a gas distribution pipeline network. *Applied Mathematical Modelling*, 33, pp. 1584-1600.
- Hwang K., Mandayan S., Udpa S.S., Udpa L., Lord W. & Atzal M. (2000). Characterization of gas pipeline inspection signals using wavelet basis function neural networks. *NDT&E international*, 33, pp. 531-545.
- Ke S.L. & Ti H.C. (2000). Transient analysis of isothermal gas flow in pipeline network. *Chem. Eng. Jour.*, 76, pp. 169-177.
- Kralik J., Stiegler P., Vostry Z. & Zavorka J. (1988). *Dynamic Modeling of Large-Scale Networks with Application to Gas Distribution*. Elsevier, Amsterdam

- Liu M., Zang S. & Zhou D. (2005). Fast leak detection and location of gas pipeline based on an adaptive particle filter. *Int. J. Appl. Math. Comput. Sci.*, 15, pp. 541-550.
- Nguyen H.H. & Chan Ch.W. (2006). Application of artificial intelligence for optimization of compressor scheduling. *Engineering Applications of Artificial Intelligence*, 19, pp. 113-126.
- Nguyen H.H., Uraikul V., Chan C.W. & Tontiwachwuthikul P. A. (2008). Comparison of automation for optimization of compressor scheduling. *Advances in Engineering Software*, 39, pp. 178-188.
- Osiadacz A.J. & Chaczykowski M. (2001). Comparison of isothermal and non-isothermal pipeline gas flow models. *Chem. Eng. Jour.*, 81, pp. 41-51.
- Osiadacz A.J. (1987). *Simulation and analysis of gas network*. E&FN Spon., London.
- Osiadacz A.J. (2001). *Steady-state simulation of gas network*, BIG, Warszawa (in Polish).
- Reddy H.P., Narasihman S. & Bhallamudi S.M. (2006). Simulation and state estimation of transient flow in gas pipeline networks using a transfer function model. *Ind. Eng. Chem. Res.*, 45, pp. 3853-3863.
- Silva R.C.C., Guerreiro J.N.C. & Loula A.F.D. (2007). A study of pipe interacting corrosion defects using the FEM and neural networks. *Advances in Engineering Software*, 38, pp. 868-875.
- Szoplík J. (2010a). Quantitative analysis of the heterogeneity for gas flow in the pipeline system. *Gaz, Woda i Technika Sanitarna*, 2010, 1, 2-6 (in Polish).
- Szoplík J. (2010b). The application of the graph theory to the analysis of gas flow in a pipeline network. *37th International Conference of SSCHE*, proceedings on CD ROM, 24-28.05.2010, Tatranske Matliare, Slovakia
- Szoplík J. (2010c). The steady-state simulations for gas flow in a pipeline network. *Chem. Eng. Trans.*, 21, pp. 1459-1464.
- Tao W.Q. & Ti H.C. (1998). Transient analysis of gas pipeline network. *Chem. Eng. Jour.*, 69, pp. 47-52.
- Zahedi G., Karami Z. & Yaghoobi H. (2009). Prediction of hydrate formation temperature by both statistical models and artificial neural network approaches. *Energy Conversion and Management*, 50, pp. 2052-2059.

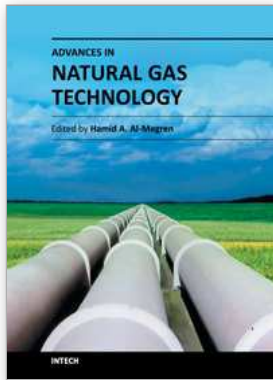

Advances in Natural Gas Technology

Edited by Dr. Hamid Al-Megren

ISBN 978-953-51-0507-7

Hard cover, 542 pages

Publisher InTech

Published online 11, April, 2012

Published in print edition April, 2012

Natural gas is a vital component of the world's supply of energy and an important source of many bulk chemicals and speciality chemicals. It is one of the cleanest, safest, and most useful of all energy sources, and helps to meet the world's rising demand for cleaner energy into the future. However, exploring, producing and bringing gas to the user or converting gas into desired chemicals is a systematical engineering project, and every step requires thorough understanding of gas and the surrounding environment. Any advances in the process link could make a step change in gas industry. There have been increasing efforts in gas industry in recent years. With state-of-the-art contributions by leading experts in the field, this book addressed the technology advances in natural gas industry.

How to reference

In order to correctly reference this scholarly work, feel free to copy and paste the following:

Jolanta Szoplik (2012). The Gas Transportation in a Pipeline Network, *Advances in Natural Gas Technology*, Dr. Hamid Al-Megren (Ed.), ISBN: 978-953-51-0507-7, InTech, Available from:

<http://www.intechopen.com/books/advances-in-natural-gas-technology/the-gas-transportation-in-a-pipeline-network>

INTECH
open science | open minds

InTech Europe

University Campus STeP Ri
Slavka Krautzeka 83/A
51000 Rijeka, Croatia
Phone: +385 (51) 770 447
Fax: +385 (51) 686 166
www.intechopen.com

InTech China

Unit 405, Office Block, Hotel Equatorial Shanghai
No.65, Yan An Road (West), Shanghai, 200040, China
中国上海市延安西路65号上海国际贵都大饭店办公楼405单元
Phone: +86-21-62489820
Fax: +86-21-62489821

© 2012 The Author(s). Licensee IntechOpen. This is an open access article distributed under the terms of the [Creative Commons Attribution 3.0 License](#), which permits unrestricted use, distribution, and reproduction in any medium, provided the original work is properly cited.