

Susceptibility of the GSM-R Transmissions to the Railway Electromagnetic Environment

Stephen Dudoyer¹, Virginie Deniau¹,
Nedim Ben Slimen² and Ricardo Adriano³

¹*Univ Lille Nord de France, IFSTTAR,*

²*Assystem,*

³*Federal University of Minas Gerais,*

^{1,2}*France*

³*Brazil*

1. Introduction

The Electromagnetic radiations are non-ionising radiations; they cannot involve the ionisation of atoms or molecules. Nevertheless, they can cause various adverse effects. From a biological point of view, they provoke heating due to the occurring of induced current in the body. But, this issue will not be considered in this chapter. From a technological point of view, they can cause malfunctions, permanent damages for electronic devices or telecommunication systems. In this chapter we will focus on their impact on a telecommunication system dedicated to the European railway and potential consequences on the management of the railway network.

Today, the European railway network is undergoing significant changes, which aim at deploying a unique management system in Europe which will replace local systems. This unique management system called ERTMS (European Railway Traffic Management System), involves the deployment of a telecommunication network dedicated to railway management, the GSM-Railway network, in order to harmonize in Europe the system of communication between the trains and the infrastructures. This harmonization is intended to clear the technological boundaries between railway networks of European countries and thus to remove border for trains. GSM-R is a key element in the management system as it provides the vocal exchanges, but also the transmission of signalling data. However, as all the telecommunication systems, the GSM-R can be vulnerable to the Electromagnetic (EM) interferences and the railway environment is particularly rich in EM interferences. This chapter will then focus on this issue.

After a general background about the electromagnetic interferences and the management of the European railway network, we present the standards and approaches applied in the railway domain to control the Electromagnetic compatibility (EMC). The GSM-R and the EM disturbances which can affect it are then detailed. Finally, a methodology for testing the vulnerability of the GSM-R transmissions and the test results are presented and analysed.

2. General notions

Understanding the electromagnetic emission from the railway environment is important to prevent and control electromagnetic interference. Currently, trains are more and more often equipped with potentially sensitive systems from an electromagnetic compatibility point of view. Consequently, railway systems have to be sufficiently robust to guarantee the safety of the railway transportation. In this section the fundamental concepts related to EMC are briefly introduced. For this purpose, the following definitions given in (IEC 60050, 1990), International Electrotechnical Vocabulary (IEV), chapter 161, apply:

Electromagnetic environment: The totality of electromagnetic phenomena existing at a given location.

Immunity (to a disturbance): The ability of a device, equipment or system to perform without degradation in the presence of electromagnetic disturbance.

(Electromagnetic) Susceptibility: The inability of a device, equipment or system to perform without degradation in the presence of an electromagnetic disturbance.

Immunity level: The maximum level of a given electromagnetic disturbance incident on a particular device, equipment or system for which it remains capable of operating at a required degree of performance.

2.1 Electromagnetic disturbances and electromagnetic compatibility

A system is electromagnetically compatible with its environment if it is able to operate satisfactorily in its electromagnetic environment without introducing intolerable electromagnetic disturbances to anything in that environment. Typically, an EMC problem can be decomposed into three main parts. A source that intentionally or unintentionally produce the emission, a coupling path that transfers the emission energy to a receptor and the receptor that can be susceptible if the received energy exceeds its immunity level.

During their operation, electrical or electronic systems generally produce radiated or conducted signals, which can lead to equipment malfunctions neighbours. The “electromagnetic disturbance” term then assigns these signals that can be voltages, currents or electromagnetic fields. In general, the higher the frequency of the electromagnetic disturbance is, the more efficient the coupling path. It is important to keep in mind that the source and receiver can be classified as intend or unintended. For instance, the GSM-R system intentionally transmits and receives electromagnetic fields in some frequencies between 876 MHz and 925 MHz. Consequently, the equipment near the GSM-R antennas must be designed to operate properly under the influence of the GSM-R signals. On the other hand, the GSM-R antenna will collect all the signals generated by the railway environment at these frequencies. Depending on the coverage of the GSM-R system and the levels of the electromagnetic disturbances, the communication between rolling stocks can be affected or even interrupted.

2.2 Electromagnetic coupling

Electromagnetic disturbances produced by the emitter can be coupled to the receptor by either radiated or conductive paths. The coupling mechanism can be classified into Conductive coupling, Magnetic coupling, Electric field coupling and Electromagnetic field coupling.

Conductive coupling can be viewed as a common impedance coupling. Conductive coupling occurs when the source and the receptor circuits are physically connected with a conductor and share a common-impedance path. Magnetic coupling occurs when two objects exchange energy through their varying or oscillating magnetic fields. It can be represented by a mutual inductance between the source and the receptor. Electric field coupling (or capacitive coupling) is caused by a voltage difference between conductors. It dominates in high-impedance circuits and can be represented by mutual capacitance. Finally, Electromagnetic coupling is a combination of both electric and magnetic fields. It is the most common coupling mechanism observed. It occurs when source and receptor are separated by a large distance, (typically more than a wavelength). In this case, source and receptor act as radio antennas. The electromagnetic field radiated by the source propagates across coupling path and is picked up by the receptor.

2.3 Electromagnetic radiation, emission and immunity

Any device which drives an electric current is likely to radiate an electromagnetic field. This electromagnetic field may act in two ways on electronic and telecommunication equipment. It can either be picked up by cables of other systems (or lines of electronic circuits) on which unwanted electrical signals appear and can cause malfunctions or it can also interfere with the telecommunication signals when they reach the receivers causing losses of information. In the first situation, the interference occurs because the dimensions of the conductors in the electronic equipment are comparable with the wavelength of the electromagnetic disturbance. In this case conducting elements can act as receiving antennas.

There are numerous sources of unintentional electromagnetic radiation such as lighting, relays, electric motors and digital systems. The number of emitters is increasing rapidly. Some of these emitters employ very high power levels; others such as digital systems are using faster digital electronics and are becoming more efficient radiators of unintentional electromagnetic energy. Consequently, EMC has become a particularly important topic. In order to ensure that EMC will be not a problem, many EMC standards are used. These are often supported by EMC legislation to ensure that existing equipment conforms to the required standards. EMC standards specify a limited number of essential emission and immunity tests, as well as minimum test levels. The aim is to ensure adequate compatibility. Section 4 summarizes the major standards concerning the electromagnetic emissions in railway environment while section 5 addresses the immunity problems.

3. Management and signalling of european railway network

The management of a railway network is generally performed thanks to several key components, notably a ground-train radio which allows the vocal exchanges, a lateral signalling system including lights and traffic signs and a localization system of the trains which can also control the speed of the trains. However, these different components are not necessarily ensured by similar technologies in all the European countries. This situation inhibits the carrying out of a real European railway network which would allow the different railway operators to offer their services anywhere in Europe. Today, trains crossing borders are necessarily equipped with various national systems and at the borders the trains have to change their system to be in accordance with the cross border country. This increases the costs of equipment and maintenance of the trains, the operating costs and extends the travel time.

The ERTMS (European Railway Traffic Management System) standard was then thought out in order to remove these obstacles and to optimize the use of the European railway network and to improve the reactivity, adaptability and affordability of the European railway. ERTMS would allow the interoperability of trains on the European territory (Jarašūnienė, 2005). This standard is generally presented as composed of two main components, which are the European Train Control System called ETCS, a standard for in-cab train control, and the GSM-R (Global System for Mobile communications-Railway) system, an international wireless communications standard dedicated to railway applications.

ETCS can allow automatically controlling the speed of the train if necessary. ETCS is composed of trackside and on-board modules. The trackside module transmits information to the train which enables the on-board computer, called Eurocab, to calculate the maximum permitted speed.

Nevertheless, the implementation of ETCS requires major adjustments on the European network, such as the installing of standard beacons called "Eurobalise" and GSM-R deployment. Indeed, the most complete version of ETCS relies heavily on the use of GSM-R. Three levels of deployment are then scheduled in order to progressively equip the railway network.

In the first level "ETCS level 1", the trackside equipment transmits information to the train in order that it calculates its maximum authorized speed. The information given by the trackside signalling (lights and traffic signs allowing the driver to know the permitted speed), can be forwarded to the train by the Eurobalise beacons located along the track.

The second level "ETCS level 2" includes a partial deployment of the GSM-R and information can then be forwarded to the train by the GSM-R. The position of trains is still detected by trackside systems but the trackside signalling is no longer necessary since all information is transmitted directly to the train.

Finally, the third level aims to optimise railway lines capacity and further reduce the trackside equipment. ETCS Level 3 is a major revision of the classic management system which is based on fixed intervals between the trains. In ETCS level 3, the route is thus no longer managed in fixed track sections but the intervals depend on the braking distances. The trains find their position themselves by means of positioning beacons or sensors and transmit the positioning signal to the radio block centre.

Then, this highlight the GSM-R is an essential and safety component in the management of the railway European network and it is necessary to warrant its immunity facing the railway electromagnetic environment (Midya, 2008).

4. Control of the radiated EM emissions in railway

The railway environment is a severe electromagnetic environment where railway equipment performs safety critical functions. Additionally, the railway runs very close to commercial and residential areas. For these reasons, it is important to provide guidance on EMC issues by applying specific EMC standards to railway applications. These standards fall generally into two categories: governmental standards, such as the EN50121:2006 part 1-5 (EN50121, 2006) published by European Committee for Electrotechnical Standardization

(CENELEC), describing EMC for railway applications, or railway industry standards such as Railtrack Group Standard GM/RC 1031 (GMRC1500, 1994), which provide guidance on EMC between railway infrastructure and trains.

A complete list of standards related to railway applications is presented and discussed in (Konefal et al., 2002), some of these standards are presented in the table 1 for convenience.

EN 50121 parts 1-5	Railway Applications Electromagnetic Compatibility
CISPR/C/116/CDV	Interference from overhead power lines, high voltage equipment and electric traction systems.
GM/RC 1500	Code of Practice for EMC between the Railway and its Neighbourhood
EN 55011 (CISPR 11)	ISM radio-frequency equipment - Radio disturbance characteristics - (CISPR 11) Limits and methods of measurement
UMTA-MA-06-0153-85-6	Conductive Interference in Rapid Transit Signalling Systems, Suggested Test Procedures for Conducted Emission Test Vehicle
UMTA-MA-06-0153-85-8	Inductive Interference in Rapid Transit Signalling Systems Suggested Test Procedures for Inductive Emissions of Vehicular Electrical Power Subsystem, Rail-to-Rail Voltage from 20 Hz to 20 kHz
UMTA-MA-06-0153-85-11	Radiated Interference in Rapid Transit Signalling Systems Suggested Test Procedures for Broadband Emissions of Rapid Transit Vehicles -140 kHz to 400 MHz

Table 1. List of EMC standards applied to railway domain

The standards applied in Europe in order to characterize the EM environment in the railway context are the EN 50121 while in USA, the electromagnetic emission limits are imposed by the Urban Mass Transportation Administration of the U.S. Department of Transport (UMTA standards). The EN 50121 standards notably aim to control the emission levels from the railway infrastructures to the outside world while UMTA standards aim to avoid interferences with the wayside equipment (transit signalling systems). In both cases, no method is proposed to characterize the EM environment on board trains, i.e. above, inside, and under the trains, especially where new and future sensitive systems can be located.

The standards EN 50121 indicate the methodologies and the limits to apply, relating to the EM emissions and immunity of railway equipment, vehicles and infrastructures. The emissions of the whole railway system, including vehicles and infrastructure are dealt with the section 2 of the EN 50121. The objective of the tests specified in this standard is to verify that the EM emissions produced by the railway systems do not disturb the neighbouring equipment and systems. The methodology then consists in measuring the radiated EM emissions at a distance of 10 m from the middle of the tracks and at about 1.5 m from the ground and to compare them with the maximum allowed levels. The limits are specified for the frequencies included between 9 kHz and 1 GHz. The measurement protocol is specified for four frequency bands which are 9 kHz-150 kHz, 150 kHz - 30 MHz, 30 MHz - 300 MHz and 300 MHz-1 GHz.

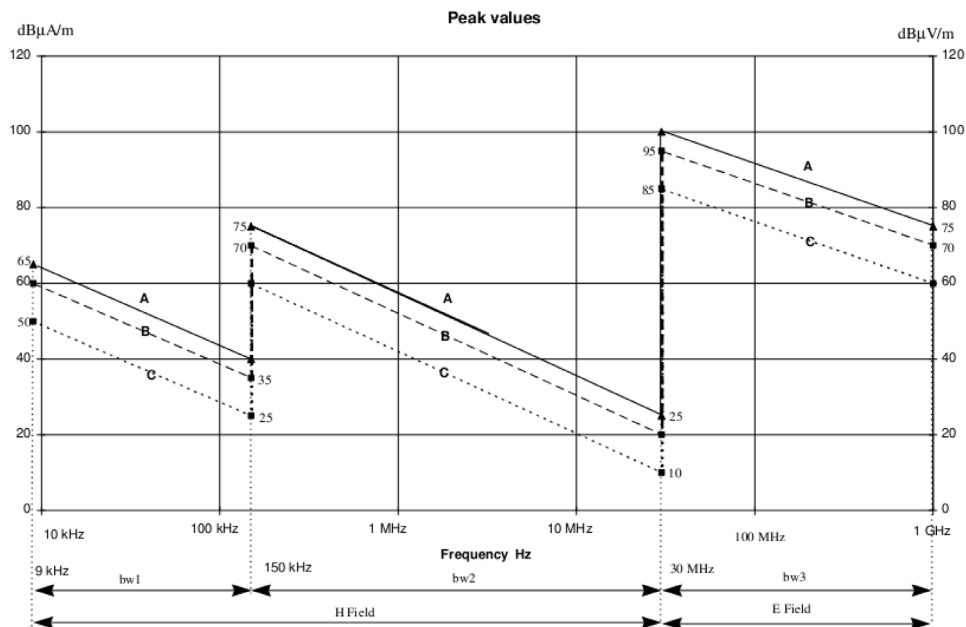

Fig. 1. Emission limits according EN 50121-2. A=25 kV ac; B = 15 kV ac, 3 kV dc or 1.5 kV dc; C = 750 V dc and bw1 = 200 Hz; bw2 = 9 kHz; bw3 = 120 kHz

The basis for the level derived in EN50121 has been the actual levels measured at a number of railways sites around Europe. While the scope of this standard covers the frequency range DC to 400 GHz, in practice limits are not set above 1 GHz. In general words, this standard does not consider the wider impact on the radio spectrum, it mostly sets the actual stage of the current levels around the railway structure.

Additionally, when comparing the EN 50121 standards to common EMC measurement standards, it is noted that there are several crucial differences in the methods of measurement. In many EMC tests, emission limits are specified in terms of a measurement with a quasi-peak detector (QP). However, the use of a quasi-peak detector in EN 50121 standards is not possible due to the highly dynamic environment. For EN 50121, a peak detector is prescribed.

5. EM immunity of the railway equipment and systems

The railway immunity levels for radiated interference are comparable with those specified by the industrial generic standard; 10V/m for trackside equipment. For rail borne equipment mounted externally to the rolling stock or within the driver's cab or passenger compartment 20V/m is specified. This level is comparable to the 24V/m specified by the Automotive Directive 95/54/EC. However, tests are different from automotive industry where full vehicle tests are performed in anechoic chamber to guarantee that all the systems can work together in the presence of electromagnetic disturbances. In the railway environment full vehicle tests are often not feasible. Due to the dimension and the speed of

the trains, they cannot be tested in nominal operating condition inside an anechoic chamber. In this context, component and sub-system testing becomes very important to prevent EMC problems.

Although the immunity levels presented in EN 50121 provide an overall view of the railway electromagnetic environment, they are not suitable to perform immunity tests on the on board components, especially in the case of modern communication systems such as GSM-R. Additionally, high speed trains as other rolling stock apparatus are supplied by a catenary. In this particular context the train can be considered as a fixed equipment supplied by an electrical network. Consequently, EMC standard EN 61000-4-4 should apply. This standard aims at defining a common and reproducible basis for the evaluation of the performances of electrical and electronic equipment facing electrical fast transients on its different inputs. It is clearly adapted to test the immunity of the electronics and we would have referred to it if our objective had been to test the electronics of a GSM-R mobile.

However, as it will be shown in section 7, the test signals defined in this standard EN 61000-4-4 differ significantly from the typical transient disturbances received by GSM-R antennas. Additionally, as presented in (Knobloch, 2002), modern communication systems use digitally coded radio signals that operate with a much smaller signal-to-noise ratio (SNR) in comparison to analogical ones. The explanation lies in the fact that digital data streams are discontinuous and include redundancy to correct errors. (Knobloch, 2002) also points out that peak detector or QP detectors are not suitable to convert electromagnetic disturbance in some measure of deterioration in communication. Consequently, it is important to envisage component immunity testing solution which permits us to evaluate the telecommunication system against electromagnetic conditions representative of the railway electromagnetic environment.

6. The GSM-R communication system

The GSM-R (Global System for Mobile communication-Railways) is a wireless digital communication system, based on the public European GSM Phase 2+. This system is used to ensure the vocal exchanges and to transmit railway signalling information between trains and railway control centres. The GSM-R is currently deployed in numerous European countries in order to ensure the interoperability of trains throughout the whole European railroad network. The GSM-R system includes two parts:

- dedicated base stations, called Base Transceiver Station (BTS) installed along the railway tracks, and connected to railroad control centres, through a wired network.
- GSM-R antennas installed on the roof of train locomotives and connected through shielded cables to GSM-R mobile on board the train, as shown in Fig. 2.

The base stations are generally spaced from about 3 or 4 km and the GSM-R signal level has to be superior to -92 dBm, 95 % of the time and the space (UIC, 2003). In practise, the power of the received signal on board train varies between -20 dBm at proximity of the base station and -90 dBm at middle distance between two successive base stations (Hammi, 2009).

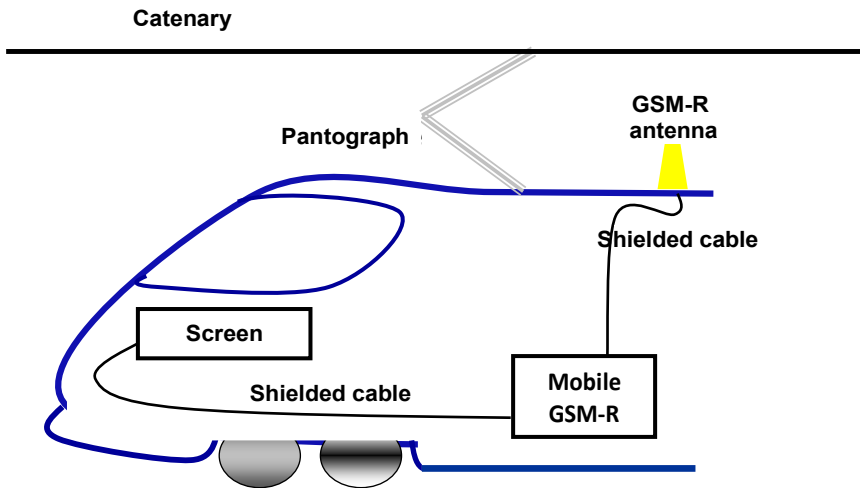

Fig. 2. Illustration of the on-board GSM-R system

The GSM-R is used in order to maintain a continuous voice and data link between the train and the control centres, and different trains located in the same neighbourhood. In the final version of ERTMS, the train sends its position through the uplink (from the train to the base stations) and receives signalling traffic information (speed limit, pass-through authorization...) through the downlink (from base stations to the train).

In Europe, the GSM-R uplink occupies the frequencies between 876 MHz and 880 MHz and the downlink between 921 MHz and 925 MHz. These frequency bands are separated by a frequency bandwidth dedicated to public and extended GSM.

Each frequency band used by the GSM-R is divided into 19 frequency channels of 200 kHz bandwidth. Only 19 channels are used by the system, in order to reduce the risk of interference with the public and extended GSM, using adjacent frequency bands.

The GSM-R is a TDMA (Time Division Multiple Access) system. The information is transmitted through each channel, according to 4.516 ms periodical TDMA frames, divided into 8 time intervals called "Time Slots" of 577 μ s. During this time slot, the transmitted information is called burst, including 156 bytes, transmitted during 3.7 μ s.

The data transmitted through the GSM-R system are very sensitive and the good operation of the GSM-R system is crucial to the capability and security of the European railway network. Thus, this system has been developed in order to be robust, with the capability of standing to some electromagnetic interference (EMI).

In fact, the GSM-R is included in the Euroradio protocol, which is specific to the railway and manages with altered received information, notably by resending some altered bursts until good reception. The use of such robust communication system is essentially motivated by the severity of the railway electromagnetic environment and the safety requirements.

In the next section we will focus on the different EMI that the GSM-R transmission signals can meet in the railway electromagnetic environment.

7. The EM noise sources affecting the GSM-R signals

On board a moving train and in normal operating conditions, the GSM-R system can meet different transient or permanent EMIs, with various amplitudes, time durations, repetition rates, frequency bands... Moreover, the GSM-R antennas are generally multi-band antennas and are not really selective around the frequency bands dedicated to the railway. They can thus receive GSM-R in-band and out-band EMIs (Mansson, 2008).

(Mansson, 2008) showed that out-band EMIs observed in railway environment could be a serious threat to the low noise amplifier (LNA) installed at the GSM-R receiver input. The susceptibility of this component can be reached with such EMIs and permanent damages on the system can happen.

In this effort, we will mainly focus on the in-band EMIs acting basically on the GSM-R useful signal. A description of the sources and different characteristics of these disturbances will be presented in the next part. Their impact on the GSM-R communication will also be described.

7.1 Description of the EM noise sources

From an EMC point of view, the railway infrastructure is a harsh complex EM environment where cohabitation between high power and digital communication systems with numerous eventual coupling mechanisms could be hazardous for the useful signal of the GSM-R. In this part, we will show that, on board moving trains, the GSM-R system is mainly affected by transient EM disturbances occurring between the catenary and the pantograph, in addition to the permanent disturbances coming from the public GSM base stations.

Fig. 3 synthesizes the different EMIs that could impact the GSM-R useful signals and describes the mechanism responsible of the generation of the transient disturbances on a GSM-R antenna fixed on the roof of a train. In fact, when a bad sliding contact occurs between the catenary and pantograph, a transient event could appear between these elements. This phenomenon can be observed with naked eye as a spark appearing between the catenary and the pantograph. Thus, a transient current circulates through these elements, which behave as transmission antennas, emitting EMI that the GSM-R antenna can receive.

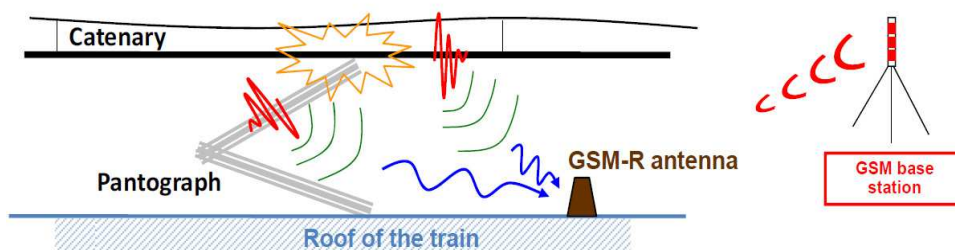

Fig. 3. EMIs received by GSM-R antenna and acting on the GSM-R useful signals

The generated wideband signal can easily cover the frequency bandwidth of the GSM-R system. However, from the train side, the GSM-R transmissions are mainly vulnerable to the EMIs covering the down-link frequency band. Indeed, on board trains, the signals emitted by the GSM-R antenna (up-link) have power levels highly superior to the power levels of the useful signals received by the antennas (down-link).

In addition, the GSM-R system uses frequency bands quietly close to the public GSM bandwidths, and when public GSM base stations use the adjacent frequency bands of the GSM-R, the risk for the GSM-R communications increases. This phenomenon is mainly observed when the train is operating in the vicinity of a city, where public GSM base stations and user numbers highly increase.

7.1.1 Transient EMI acting on the GSM-R useful signal

Measurement campaigns carried out on board moving trains (Hammi, 2009) showed that the transient events, triggered when a bad sliding contact occurs between the catenary and the pantograph, are the most penalizing events for the GSM-R useful signals. Fig. 4 (a) shows an example of a transient signal recorded by an oscilloscope connected to a GSM-R antenna. The analysis of a large number of transients collected on board trains showed that their time duration is generally inferior to 20 ns (Ben Slimen, 2009), with a typical value of 5 ns and a typical value of the rise time is 0.4 ns. Fig. 4 (b) shows the maximal EM amplitude generated by 284 successive transient events on the downlink frequency band of the GSM-R in normal operation conditions. Each point in this graph links the rank of the recorded transient and its maximal amplitude within the 921 - 925 MHz frequency band, corresponding to the down-link frequency band.

These results show that these transients generate high level EMIs that can reach -40 dBm. Moreover, statistical analysis (Ben Slimen, 2009) of these transient disturbances highlighted that they can be very frequent, especially on high speed lines.

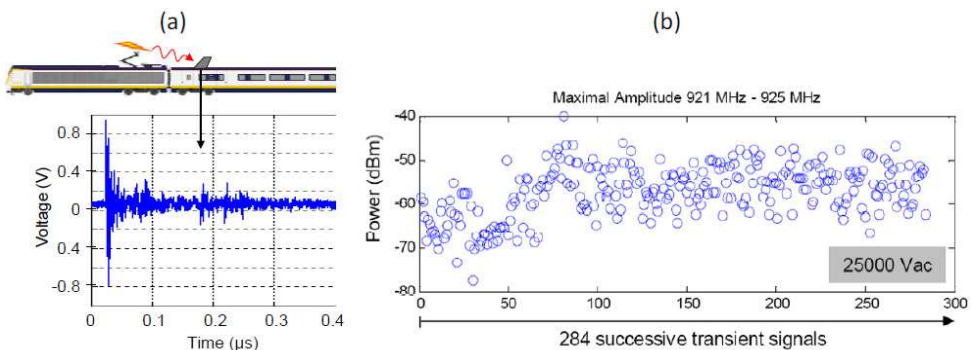

Fig. 4. (a) Example of transient disturbance in time domain and (b) maximal EM power generated by 284 successive transients in downlink GSM-R band

7.1.2 Permanent EMI acting on GSM-R antenna

Measurement campaigns have been carried out on board moving train, on railway lines equipped with the GSM-R system, in order to show the relation between the public GSM signal and the permanent interferences that can be observed in the closest downlink GSM-R frequency channel to the public GSM band (Hammi, 2009).

In Fig. 5 the top curve gives the variation of the EM power signal obtained through the last GSM-R channel along 20 km. The second one is the result obtained into an intermediary channel, supposed to be free. The last curve is obtained through the first public GSM frequency channel.

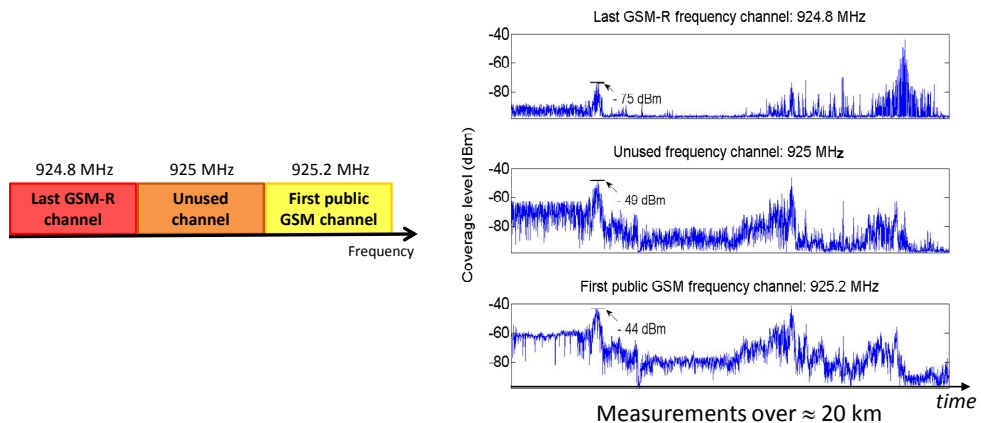

Fig. 5. EM measurement in different frequency channels used by the GSM-R and public GSM along 20 km railway line equipped with GSM-R system

Fig. 5 shows clearly that the variation of the measured amplitudes into the unused frequency channel and the last GSM-R frequency channel are partially similar to the EM noise variation observed through the first public GSM channel. This result proves that the public GSM signal sent through the first channel can disturb the GSM-R bandwidth, and confirms that the public GSM signal can be considered as a serious threat to the GSM-R useful signal. Indeed, as can be seen on Fig. 5, a signal of -44 dBm on the first public GSM channel induces an EMI of -75 dBm on the last GSM-R frequency channel. Knowing that the GSM-R signal level can decrease to a minimum value of -92 dBm (UIC, 2003), this interference level can be sufficient to severely disturb a GSM-R transmission on this channel.

7.2 Impacts of the EM noises

According to the type of the disturbance affecting the GSM-R system, the effect of the received EMI can vary. In fact, the transient events taking place between the catenary and the pantograph are wideband disturbances that can affect all the frequency channels used by the GSM-R system. It is obvious that the useful signal sent through the GSM-R system at the occurrence of the transient disturbance will be somehow disturbed. In fact, compared to the 3.7 μ s time duration of one GSM-R bit, the transient duration of some ns is quietly small. So we need to investigate the real impact of such short time duration events on the

interpretation of a disturbed GSM-R bit. This work will be presented in the next part of this effort.

When it comes to permanent EM disturbances coming from the public GSM base stations, the impact of these disturbances can be mainly observed when the GSM-R system is using the last frequency channel and the public GSM system is using the first frequency channel. So, even if the last frequency band of the GSM-R system is affected by the public GSM signal, the useful GSM-R signal is not necessary affected. In fact, when such scenario occurs, the GSM-R system could use different advanced protocols, mainly Euroradio protocol that can allow the system to stand to such disturbances. However, when the whole GSM-R channels are used, the system could be really affected by these disturbances.

However, among the current EMC standards, none methodology of immunity testing is adapted to the GSM-R system and to the characteristics of the EMIs that it can meet in the railway environment. The next section is then focused on a specific immunity approach to this system in order to assess the real risks for the GSM-R transmissions.

8. Immunity testing of the GSM-R signals in laboratory

8.1 Methodology

To evaluate the impact of the interferences on the quality of the GSM-R transmissions, a GSM-R mobile was employed. This mobile can be connected to one network either simulated by a specific piece of equipment or coming from a base station installed at proximity. In our case, we use a network simulator allowing controlling the network parameters such as GSM-R channel used for the communication, power of signals... and performing BER measurements. The principle of this methodology of test is to first connect the mobile to the simulated network and to establish a communication with the simulator. Then, the EM disturbance signals (permanent noise + transient signals) were generated and their impact on the quality of the GSM-R communication was evaluated thanks to criteria introduced in the following paragraph. Fig. 6 gives an illustration of this test methodology.

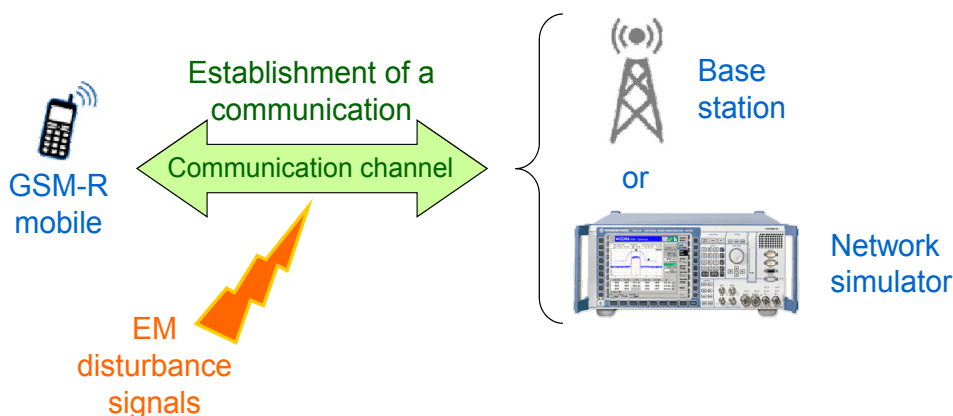

Fig. 6. Principle of the employed methodology of test

8.2 Definition of the immunity criteria

Two immunity criteria can be employed: Rxqual and Bit Error Rate (BER). The BER corresponds to the percentage of erroneous bits in a given transmission length (Breed, 2003):

$$\text{BER} = \frac{\text{Number of erroneous bits}}{\text{Total number of bits}} \times 100\% \quad (1)$$

The Rxqual is a quality parameter measured by the GSM-R mobile and it defines the quality of the received signal on a level from 0 to 7 (the lower the Rxqual is, the higher is the quality). The Rxqual is linked to the BER calculated on the learning sequences included in the GSM-R frames. The specifications defined in standards such as (ITU-T, 2003) require that the Rxqual is inferior or equal to 3 in order to ensure a good quality of communication. A relationship exists between BER and Rxqual: each value of Rxqual is associated with a range of values of BER (Lagrange et al., 1996) as can be seen in the following table.

RXQUAL	BER	
Quality level	Range of values	Typical value
0	BER < 0.2 %	0.14 %
1	0.2 % < BER < 0.4 %	0.28 %
2	0.4 % < BER < 0.8 %	0.57 %
3	0.8 % < BER < 1.6 %	1.13 %
4	1.6 % < BER < 3.2 %	2.26 %
5	3.2 % < BER < 6.4 %	4.53 %
6	6.4 % < BER < 12.8 %	9.05 %
7	12.8 % < BER	18.10 %

Table 2. Correspondence table between BER and Rxqual

8.3 Employed test bench

The test bench which was employed to perform immunity tests in laboratory is presented in Fig. 7. This test bench aims at reproducing the EM conditions that the GSM-R system is susceptible to meet on board trains. It is composed of three main parts:

- the communication system which consists in a GSM-R mobile connected to a network simulator called CMU 200 from Rohde & Schwarz.
- the EM noise generation which permits us, thanks to the two signal generators, to simulate the presence of permanent and EM transient noises simultaneously or separately.
- the area "analysis in frequency domain" is used to control the power of the exchanged signals at the input of the GSM-R mobile.

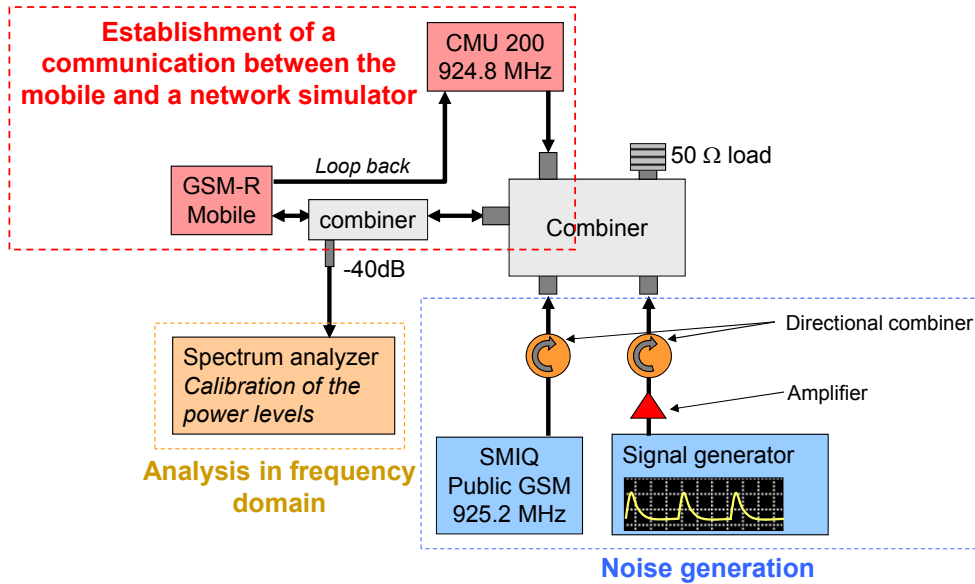

Fig. 7. Employed immunity test bench

8.4 Employed test signals

The GSM-R communication is established using the last useful GSM-R channel (924.8 MHz) from the down-link frequency band. The power level of the signals generated by the network simulator is adjusted so as to obtain a level of -70 dBm at the input of the GSM-R mobile. That corresponds to realistic operational conditions on board trains.

As for the public GSM signals, the communication channel employed is the first one (925.2 MHz) which is adjacent to the last useful GSM-R channel (924.8 MHz) used for the tests. The level of these signals is variable in order to study the effect produced on the quality of the GSM-R communication depending on the power level of the interference signals.

The signal used to simulate the presence of transient signals is a double exponential (duration=5ns, rise time=0.4 ns) modulated by a sinus at the frequency 923 MHz which corresponds to the center frequency of the GSM-R down-link frequency band. The corresponding mathematical expression is the following one:

$$S(t) = A \times \left(e^{-\frac{1}{D}t} - e^{-\frac{1}{RT}t} \right) \times u(t) \times \sin(2\pi Ft) \quad (2)$$

where $D=5$ ns, $RT=0.4$ ns, $F=923$ MHz and u is the unit step function.

The values employed for rise time (RT) and duration (D) result from a statistical analysis we performed on transients collected on board trains during one measurement campaign (Ben Slimen, 2009). Fig. 8 gives the time representation of this test signal.

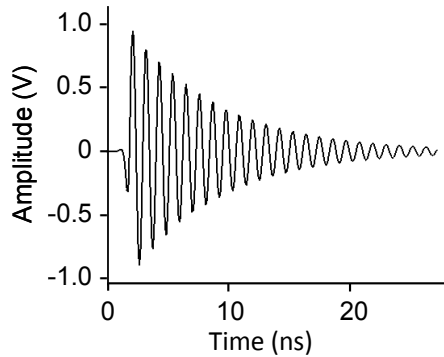

Fig. 8. Used transient test signal

Contrary to duration and rise time, it is not possible to determine a typical value for the recurrence of transients since it is very variable and depends on several operating conditions (speed of the train, one or two pantographs, state and age of the catenary and pantograph...). During the measurement campaign performed on board trains, we generally noticed that very few transients appeared at low speed whereas they could occur with a time interval of about $5 \mu\text{s}$ at about 200 km/h. As a consequence, the recurrence of transients is considered as a variable parameter for the immunity tests: for each measurement, the transient disturbances are generated with a constant time interval (TI) between two successive transients as illustrated in Fig. 9 and the immunity results are given in relation to the value of the time interval.

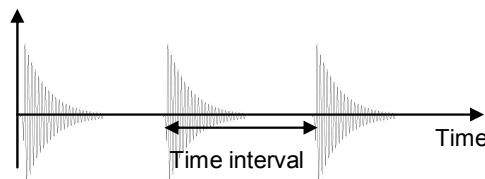

Fig. 9. Illustration of the time interval (TI) between the successive transient disturbances

9. Results of EM immunity tests on GSM-R transmissions

9.1 Configurations of test

Three different configurations, as shown on Fig. 10, are considered when studying the effect produced by the interference signals on the quality of the GSM-R transmissions:

- presence of public GSM signals only,
- presence of transient signals only,
- presence of public GSM and transient signals simultaneously.

The aim is, in a first step, to observe and quantify the impact of each type of interference separately and in different conditions of test (different power levels for permanent interferences, different time intervals for transient interferences...). In a second step, the combined effect of the two types of disturbances is assessed.

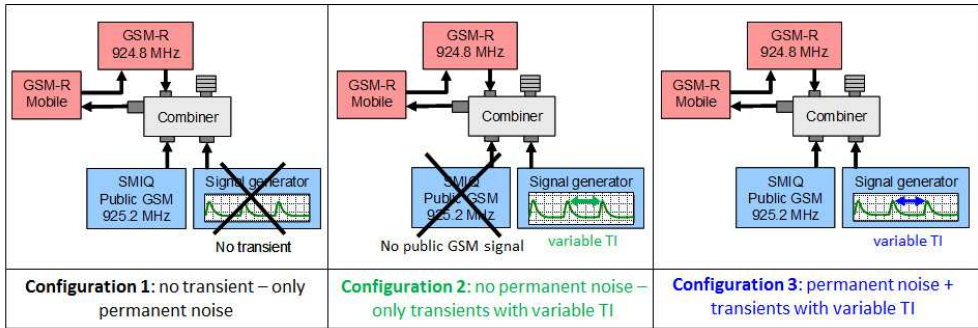

Fig. 10. The different configurations used for immunity testing

9.2 Impact of public GSM signals

The configuration of test corresponds to “configuration 1” from Fig. 10. As previously explained in paragraph 8.4, the GSM-R transmissions takes place on the channel 924.8 MHz with a power level of -70 dBm and the public GSM ones on the channel 925.2 MHz with a variable level from -72 to -12 dBm. Fig. 11 presents the results of the BER measurements as a function of the power level of public GSM signals. The vertical axis gives the value of the BER in % and the horizontal axis represents the power level of the public GSM band signal (on the channel 925.2 MHz) which induces the permanent noise on the GSM-R channel.

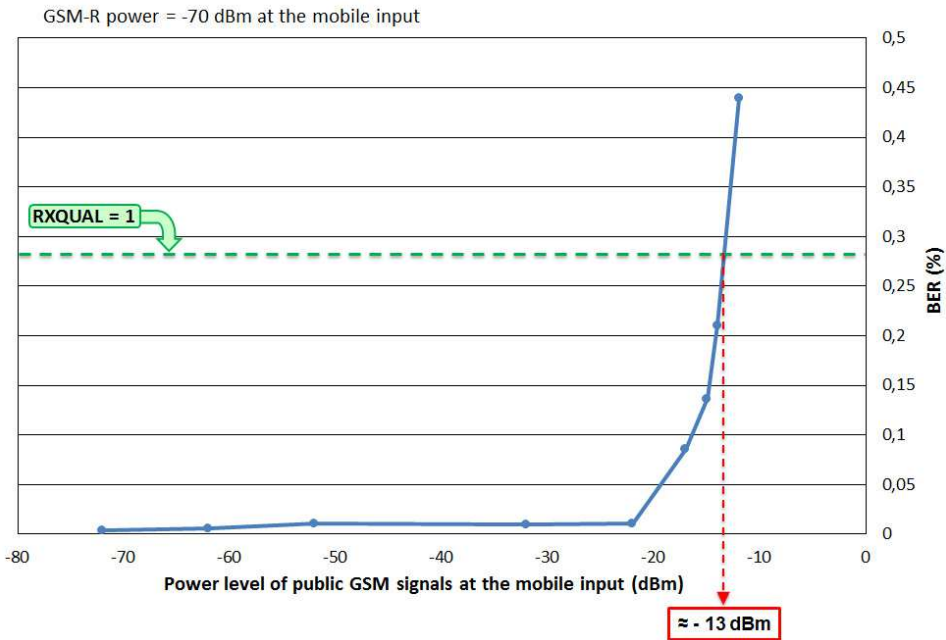

Fig. 11. Results of the BER measurement in the presence of public GSM signals

In Fig. 11, the public GSM signal has to exceed -20 dBm to start affecting the quality of the GSM-R communication (the BER starts to increase). That means that the interference signals on the 400 kHz adjacent channel have to be 50 dB higher than the wanted signal on the GSM-R communication channel to deteriorate the quality of the transmission, which well complies with the specifications (ETSI, 2000). Indeed, the standard EN 300 910 stipulates that a mobile has to tolerate a 400 kHz adjacent interference level of -50 dB.

Then, we also notice that a level of -13 dBm is necessary to induce a Rxqual equal to 1. It will be highlighted later that this level is different when transient interferences are simultaneously present.

9.3 Impact of transient EM interferences produced by catenary-pantograph sliding contact

These tests and measurements are related to “configuration 2” in Fig. 10. The GSM-R signal can be set to the desired value and the interference level produced by transient signals on the GSM-R frequency band can be controlled by using a variable attenuator in order to obtain the desired signal-to-noise ratio (SNR) at the mobile input. As for the measurements, during a test sequence we vary the time interval between two consecutive transients and one measure of BER is made for each chosen time interval. Then, the same test sequence is applied with one other signal-to-noise ratio. Three different SNR at the mobile input are tested: +5, 0 and -5 dB. The results are presented in Fig. 12 where the vertical axis of the graph corresponds to the value of the BER in % and the horizontal axis gives the time interval between two successive transients in μs .

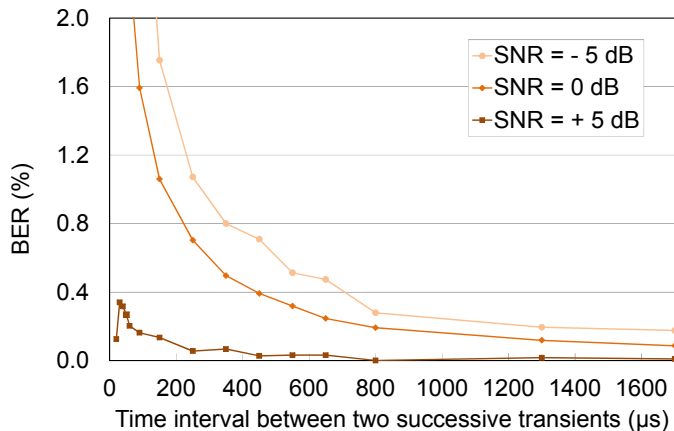

Fig. 12. Results of the BER measurement in the presence of transients for different values of the signal-to-noise ratio (SNR)

The first thing to notice is that the BER evolves with the time interval between transients: it increases with the recurrence of transients. Indeed, the BER is higher for small values of time interval whatever the value of the SNR. In (Adriano, 2008), a relation was proposed to estimate the BER from the TI between the transient interferences, under the assumption that the SNR is equal to 0 dB.

The second thing to observe is that the SNR has an impact on the BER. Indeed, if taking the curve obtained for SNR = 0 dB (at the mobile input) as a reference, we see that, when the transient level is 5 dB higher than the GSM-R signal (SNR=-5 dB), the measured BER increases. Consequently, the transmission could be more severely disturbed when the SNR decreases to -5 dB whereas, in the reverse case (SNR=+5 dB), the BER is lower (less than 0.4 %) which guarantees a good quality of communication whatever the recurrence of the transient interferences.

9.4 Tests and measurements in the presence of both types of interference signals simultaneously

In this section, we now consider "configuration 3" in Fig. 10: presence of permanent noise and transients simultaneously with two arbitrarily chosen values for the transient time interval which are TI=150 μ s and TI=550 μ s. The following graph, on the right of Fig. 13, shows the results of the BER measurements in this configuration of test. The first curve (black one with points) corresponds to the evolution of the BER without transient and the two others (orange with squares and blue with triangles ones) with transients for the two considered values of time interval. These values were chosen so that 3 transients can occur during the time duration of one GSM-R burst in the first case (TI=150 μ s) and only one in the second case (TI=550 μ s), as can be seen in the illustration on the left of Fig. 13.

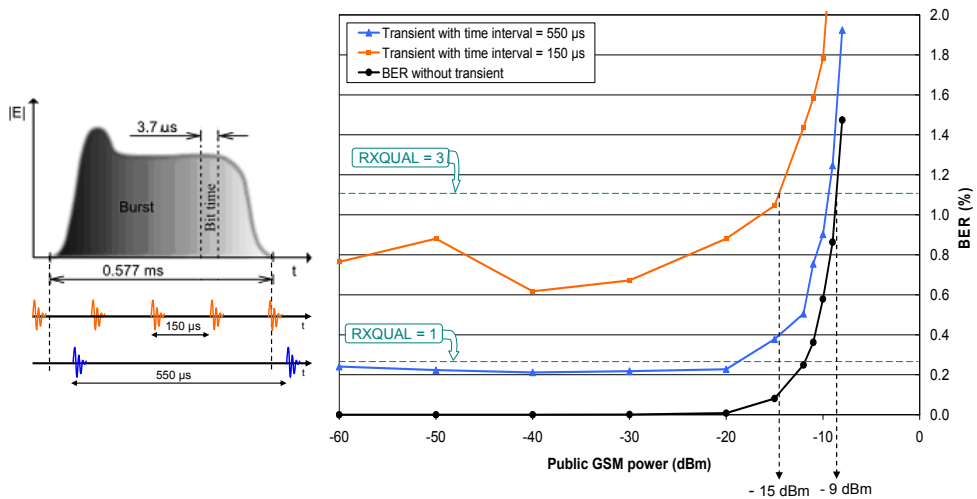

Fig. 13. Results of the BER measurements in the presence of public GSM signals and transient signals with GSM-R signal power = -70 dBm at the mobile input

In the absence of transient signals (black curve with points), the public GSM signals have to reach a power level of -9 dBm to induce a Rxqual equal to 3 whereas in the presence of transient disturbances with a time interval of 150 μ s, a level of -15 dBm is sufficient. In other words, the impact on the GSM-R communication of the transient disturbances "adds" to the one of signals in the public GSM band. We thus conclude that the susceptibility of the GSM-R to permanent noise is higher in the presence of transient disturbances.

Obviously, these results are linked to the GSM-R signal power used for the test (-70 dBm) and we would obtain a better level of immunity if setting up the GSM-R signal to a higher level of power. However, we are not going to develop this point in this chapter, since further studies on the immunity of the GSM-R system can be found in (Dudoyer et al., to be published).

10. Conclusion

This chapter outlined the major developments underway on the European rail network and highlighted the electromagnetic vulnerability of the GSM-R which is a key component of the management system. Indeed, immunity testing carried out in laboratory to confront the GSM-R transmissions to EM disturbances representative to those measured on trains, have shown that the quality of the transmissions can be significantly affected. The results of the section 9 highlighted that the impact of the transient disturbances on the quality of the GSM-R transmissions is linked to two main factors: the levels of noise produced on the GSM-R down-link frequency band and the repetition rate of the transient disturbances. Moreover, their impact can also be related to the presence of permanent interferences with the GSM public. Consequently, the assess of the risks of disturbances of the GSM-R transmissions requires to monitor the spectral distribution of the EM noise over the time, and with a high temporal resolution which permits us to perform direct comparison with the transmission of the digital data.

The current European standard methodologies of measurement of the EM emissions in the railway domain (EN 50121, 2006) which only consist in spectral analysis of the radiated emissions without taking into account the time dimension are then not adapted to the control of the EM emissions in order to protect the GSM-R transmissions. This chapter which proposed a methodology to perform immunity testing of GSM-R transmissions in laboratory, has also highlighted the main features of the EM noise it is necessary to characterize on board trains to ensure that the radiated emissions will not affect the ability of the GSM-R system.

11. Acknowledgment

The authors of this chapter would like to thanks SNCB and SNCF to have given them access to their trains to perform measurements in real conditions and also ALSTOM which provided them specific railway equipment. This work was performed in the framework of the RAILCOM project supported by the PCRD 6 and CISIT projects supported by the North Region and the FEDER.

12. References

- Adriano, R., Ben Slimen, N., Deniau, V., Berbineau, M. & Massy, P. (2008). Prediction of the BER on the GSM-R communications provided by the EM transient disturbances in the railway environment, *Proceeding of EMC Europe*, pp. 771-775, Hamburg, Germany, September 2008.
- Ben Slimen, N., Deniau, V., Rioult, J., Dudoyer S. & Baranowski S. (2009). Statistical characterisation of the EM interferences acting on GSM-R antennas fixed above

- moving train. *The European Physical Journal Applied Physics*, Vol. 48, No.2, (2009), ISSN 1286-0042
- Breed, G. (2003). Bit Error Rate: Fundamental Concepts and Measurement Issues. *High Frequency Electronics*, Vol.2, No.1, (January 2003), pp. 46-48
- Dudoyer, S., Deniau, V., Adriano, R., Ben Slimen, M. N., Rioult, J., Meyniel, B. & Berbineau, M. (to be published). Study of the Susceptibility of the GSM-R Communications to the Electromagnetic Interferences of the Rail Environment, *accepted for publication in IEEE Transactions on electromagnetic compatibility*.
- EN 50121. (2006). European standards for Railway applications: Electromagnetic Compatibility-Part 1-5
- ETSI EN 300 910 V8.5.1 (2000). European Standard on Digital cellular telecommunication system (Phase 2+); Radio transmission and reception, November 2000.
- GM/RC 1500, (1994). Code of Practice for EMC between the Railway and its Neighbourhood, December 1994
- Hammi, T., Ben Slimen, N., Deniau, V., Rioult, J. & Dudoyer, S. (2009). Comparison between GSM-R coverage level and EM noise level in railway environment, *Proceedings of the 9th International Conference on Intelligent Transport System-Telecommunications, ITST 2009*, pp. 123-128, Lille, France, October 2009
- IEC 60050-161. (1990). International Electrotechnical Vocabulary. Chapter 161: Electromagnetic compatibility, Edition: 1.0, International Electrotechnical Commission, 1990
- ITU-T Recommendation K.48 (2003). EMC requirements for each telecommunication equipment - Product family Recommendation, July 2003.
- Jarašūnienė, A. (2005). General Description of European Railway Traffic Management System (ERTMS) and Strategy of ERTMS implementation in Various Railway Managements, *Transport and Telecommunication*, Vol.6, No.5, (2005), pp. 21-27, ISSN 1407-6160
- Knobloch, A. & Garbe, H. (2002). Critical Review of Converting Spectral Data into Prospective Bit Error Rates, *Proceeding of IEEE International Symposium on Electromagnetic Compatibility, Volume 1*, pp. 173-178, ISBN 0-7803-7264-6, Minneapolis, MN, USA, August 2002
- Konefal, T., Pearce, D.A.J., Marshman, C.A. & McCormack, L.M., (2002). Potential electromagnetic interference to radio services from railways, *Final Report, University of York*, 2002, Retrieved from <<http://www.yorkemc.co.uk/research/railways/>>.
- Lagrange, X., Godlewski, P. & Tabbane, S. (1996). GSM-DCS Networks, Hermès, Paris, 1996, pp. 207-208, ISBN 2-86601-558-4
- Mansson, D., Thottappillil, R., Bäckström, M & Lundén, O. (2008). Vulnerability of European Rail Traffic Management System to Radiated Intentional EMI. *IEEE Transactions on Electromagnetic Compatibility*, Vol.50, No.1, (2008), pp. 101-109, ISSN 0018-9375
- Midya, S. & Thottappillil, R. (2008). An Overview of Electromagnetic Compatibility Challenges in European Rail Traffic Management System, *Journal of Transportation Research Part C: Emerging Technologies*, Elsevier, (Ed.), Vol.16C, Issue.5, (2008), pp. 515-534, ISSN 0968090X
- UIC Project EIRENE (2003). System Requirements Specification, v14.0, 21 October 2003. Source : EIRENE Project Team

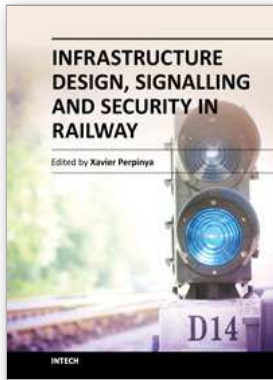

Infrastructure Design, Signalling and Security in Railway

Edited by Dr. Xavier Perpinya

ISBN 978-953-51-0448-3

Hard cover, 522 pages

Publisher InTech

Published online 04, April, 2012

Published in print edition April, 2012

Railway transportation has become one of the main technological advances of our society. Since the first railway used to carry coal from a mine in Shropshire (England, 1600), a lot of efforts have been made to improve this transportation concept. One of its milestones was the invention and development of the steam locomotive, but commercial rail travels became practical two hundred years later. From these first attempts, railway infrastructures, signalling and security have evolved and become more complex than those performed in its earlier stages. This book will provide readers a comprehensive technical guide, covering these topics and presenting a brief overview of selected railway systems in the world. The objective of the book is to serve as a valuable reference for students, educators, scientists, faculty members, researchers, and engineers.

How to reference

In order to correctly reference this scholarly work, feel free to copy and paste the following:

Stephen Dudoyer, Virginie Deniau, Nedim Ben Slimen and Ricardo Adriano (2012). Susceptibility of the GSM-R Transmissions to the Railway Electromagnetic Environment, Infrastructure Design, Signalling and Security in Railway, Dr. Xavier Perpinya (Ed.), ISBN: 978-953-51-0448-3, InTech, Available from:

<http://www.intechopen.com/books/infrastructure-design-signalling-and-security-in-railway/susceptibility-of-the-gsm-r-transmissions-to-the-railway-electromagnetic-environment>

INTECH

open science | open minds

InTech Europe

University Campus STeP Ri
Slavka Krautzeka 83/A
51000 Rijeka, Croatia
Phone: +385 (51) 770 447
Fax: +385 (51) 686 166
www.intechopen.com

InTech China

Unit 405, Office Block, Hotel Equatorial Shanghai
No.65, Yan An Road (West), Shanghai, 200040, China
中国上海市延安西路65号上海国际贵都大饭店办公楼405单元
Phone: +86-21-62489820
Fax: +86-21-62489821

© 2012 The Author(s). Licensee IntechOpen. This is an open access article distributed under the terms of the [Creative Commons Attribution 3.0 License](#), which permits unrestricted use, distribution, and reproduction in any medium, provided the original work is properly cited.