

Optical Fiber Gratings in Perspective of Their Applications in Biomedicine

Vandana Mishra and Nahar Singh
Central Scientific Instruments Organisation, Chandigarh
Council of Scientific and Industrial Research (CSIR),
New Delhi
India

1. Introduction

Optical fiber is a flexible, transparent *waveguide* or "*light pipe*" to transmit light; the latter, in its various forms and facets has caught the attention of humanity since prehistoric times. The ancient civilization used it as fire signals to communicate and later as a therapeutic and preventive tool for better health. In the modern era, the idea that light can be used for communication combined with the phenomenon of total internal reflection, gave rise to the concept of medium for light transmission. As a consequence, by the end of 19th century glass rods as illuminators were realized. Optical fibers were the next step as they are basically glass rods stretched very thin to become long and flexible. Gradual technological advances from 1920s when use of fiber for light transmission was first proposed, to 1980s resulted in glass fibers as the most ideal communication medium for enormous amount of data with lowest possible attenuation. Their inherent properties such as small size (have standard thickness of ~ 0.250 mm that can be less than that of surgical suture), biocompatibility, non-toxicity, chemical inertness and remote monitoring capability, make them quite lucrative for usage in the biomedical area. These fibers thus have diverse applications ranging from illumination to imaging, from phototherapy to precise surgery, from monitoring complex biomechanical dynamics to wearable smart sensors. In fact, after their first practical application in flexible endoscopes reported by Basil Hirschowitz in 1957 for illuminating and imaging internal organs of human body, the optical fibers have come a long way as sensors for various physiological parameters as well. This book chapter describes a special type of fiber optic tool, called fiber grating, its unique features with reference to potential applications in the field of biomedicine not only as in-fiber devices but also as sensing elements. (Mishra, 2011)

2. History

Although glass fibers as endoscope were being used for medical applications since 1950s, they had very limited applications because of their very high power loss (~ 1000 dB/km) and non availability of a compatible light source. The solution for the second problem came with the first Laser fabrication in 1960 by Maiman that had the potential to be ideal light source

for optical fibers. After this and a revolutionary prediction in 1966 by ¹C.K. Kao and George Hockham that a purer fiber with 10 or 20 decibels of light loss per kilometer is possible to produce, there was a spurt of fiber based research activities worldwide. In 1970, two important breakthroughs happened i.e. first fiber with loss less than 20 dB²/km was fabricated and room-temperature operation of semiconductor laser was demonstrated; the latter became an ideal source for optical communication. (Hecht, 1999) By 1985, optical fibers with lowest possible loss (~0.2 dB/km) were being produced routinely. In that decade, research reached its pinnacle with optical fiber as a communication medium had been standardized to perfection. To quote *Philip Russell* "standard fiber had become a highly respected elder statesman with a wonderful history but nothing new to say". (Russell, 2003). Thus subsequent advancement required exploring newer avenues like in-fiber devices and fiber optic sensors. In-fiber devices are essential for easier interconnection between fiber as communication medium and transmitter and receiver parts to complete efficient telecommunication. Other non-telecommunication applications, though started as spin-off, had been emerging simultaneously.

Concurrently, after the demonstration of fiberscopes further development in the quality of fibers and compact light sources resulted in a new offshoot of fiber optics i.e. fiber based sensors and other devices which were able to extract information about various aspects of human physiology by analyzing the reflected laser light sent and received through fibers. This method has been used in laser Doppler analysis of different cells. Study of scattered light is used to detect blood velocity to determine if sufficient blood is reaching vital organs. It can also detect the oxygen content of the blood. Miniature sensors at the end of an optical fiber were devised to measure pressures in the arteries, bladder, urethra and rectum. Some chemical analysis was also possible utilizing the phenomenon of luminescence. (Katzir 1989, Mishra et al 2009).

The discovery of grating formation in optical fibers by Hill and Coworkers in 1978 is a good example of serendipity! While studying non-linear properties of germanium doped silica by passing intense Argon ion laser radiation, they found an unexpected reflection and concluded that it was because of formation of Bragg reflection gratings inside the fiber core. This formation was attributed to interference between forward propagating wave and back reflected radiation from the far end of the fiber resulting in standing wave pattern. A refractive index distribution with the same periodicity as the interference pattern is thus created in the fiber core. This periodic perturbation of refractive index is a result of ³'photosensitivity' phenomenon in certain kind of doped fibers. Introducing a variation of refractive index with periodicity on the scale of wavelength of light alters the light-matter interaction like a grating and results in selective reflection of light. Initially this phenomenon was just a scientific curiosity but after its first practical demonstration by Meltz in 1989,

¹ A part of 2000 Nobel Prize in Physics was awarded to Z.I. Alferov for his invention of semiconductor laser and that of 2009 to C.K. Kao for his "groundbreaking achievements concerning the transmission of light in fibers for optical communication"

² The dB(decibels) is related to the ratio of output optical power from an optical fiber to the input optical power; If an input power P₁ results in an output power P₂, the loss in decibels is given by;
 $\alpha \text{ dB} = 10 \times \text{Log}_{10} (P_1/P_2)$

³ photosensitivity: the change in optical properties of material on exposure to light

there had been explosion of research activity in this field. (Kashyap, 2009, Othonos & Kallis, 1999)

3. Fiber gratings

Fiber gratings are one of the simple intrinsic fiber devices that can reflect, filter or disperse light passing through them, suitable not only for communication applications but also finding their foothold as a fascinating sensor element in diverse areas. Figure 1 shows the schematic representation of a typical single mode fiber with fiber grating inscribed in its core.

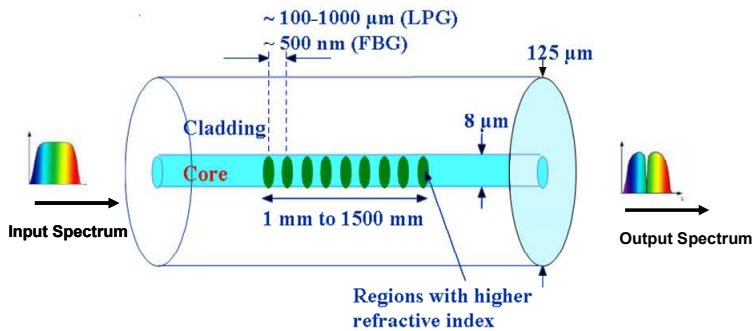

Fig. 1. Schematic representation of a fiber grating

3.1 Special features

Optical fibers are long and flexible waveguides generally made of fused silica (amorphous silicon dioxide, SiO₂) the most abundant mineral found in the earth crust. Though plastic optical fibers made of polymers are also quite practical and inexpensive for some applications, our focus here is on silica fibers which are the backbone of optical communication today. Their potential as efficient sensor elements was recognized simultaneously because of the unique advantages they offer, such as:

- i. Small size and geometric versatility: with diameter in the range of 125 -500 micrometers, fiber sensors can be configured in arbitrary shapes and offer a great choice in space-restricted or hard to reach environments.
- ii. Common technology base for multiparameter sensing: a single fiber can be used to sense various physical perturbations (acoustic, magnetic, temperature, strain, pressure, rotation, etc.)
- iii. Compatibility with communication fiber facilitates telemetry
- iv. Absence of crosstalk between close fibers suggests that different sensors can be housed in close vicinity e.g. a catheter.
- v. A single electro-optic unit can be utilized for all the sensors, naturally with an appropriate illumination, detection and signal-processing scheme.

⁴ "Grating" here is used in the sense of "diffraction grating" which is usually a periodic structure having very fine parallel grooves or slits and used to produce optical spectra by diffraction of light.

- vi. Optical fibers have very low attenuation and thus long fiber links can be used to remotely monitor and control the sensing parts without disturbing the patient while keeping all the electronics away.
- vii. Immunity to electromagnetic/ radiofrequency interference and chemically inert nature: due to their dielectric construction, they can be used in high voltage, electrically noisy, high magnetic field, high temperature, corrosive, or other harsh environments

Along with these, fiber gratings offer some added features unique to them like self-referencing as the information is wavelength encoded and ease of multiplexing, facilitating distributed sensing, that make them more valuable as sensors. Their potential as strain and temperature sensors array in various concrete, metal and composite structures has been established much earlier and they have been implemented successfully for *structural health monitoring (SHM)* in the arena of civil and aerospace, oil & gas exploration wells, power systems monitoring, etc. (Rao 1997, Majumdar 2008, Tiwari 2009)

3.2 Relevance in biomedicine

Because the fiber gratings are made of dielectric glass, they are inherently immune to electromagnetic interference (EMI) and can be safely used without any electrical or chemical obstruction in a clinical setup. Their miniature size, flexibility, and lightness allow easy insertion in catheters/ needles making possible localized measurements inside blood and tissues. Also, multiple sensors can be accommodated on a single fiber, working independently of the other. Silica is chemically inert and fulfills the biocompatibility criterion. (Davis 1972, Yang 2003) As fibers are intrinsically safe for the patient i.e. their use produces no immunity response from human defense system, they can be used for *in-vivo* measurements and can be left in their position for repeated or continuous monitoring.

Although all these qualities are quite exciting there are some issues coming into the way of fiber grating technology to become accepted in healthcare systems that remain to be dealt with. For example, howsoever small or non-intrusive these sensors are for the patient, their read out units need to be connected through a fiber link which is not so practical in the modern world of wireless technology. With the emergence of smaller and faster interrogators one possible way out can be the development of very small wearable interrogator system with no external fiber links. Another issue is information extraction process that needs to be standardized for each application. Fiber gratings provide information in terms of wavelength shift (given by equations 2-5 in the next section) that can be due to changes in various external parameters e.g. strain, temperature, pressure, refractive index (RI) etc. when the sensor is being used for one specific measurand (strain for example) it should be unaffected by all other parameters (temperature, RI etc.) to minimize error. This can be achieved by using optimized packaging/transducer. Also, if one sensor is being used for multiparameter sensing, it will require customized interrogation system and software tool to discriminate the effect of each parameter. Practical solutions of all these issues require multidisciplinary approach with a synergy between various experts e.g. doctors, physicists and engineers.

4. Working principle

Optical fiber consists of an inner dielectric core surrounded by cladding of another dielectric material of slightly lower refractive index than that of core. In the simplest case, the

waveguide effect is often explained as resulting from repeated total internal reflection (TIR) of light rays at the core-cladding interface. The fiber can then guide all light impinging the input face under certain conditions. Standard fibers have core and cladding refractive indices constant along the fiber length, but if a periodic modulation of refractive index is created deliberately along the fiber core it results in formation of fiber gratings.

The periodic variation of refractive index in the fiber core is created mostly by its exposure to Ultraviolet (UV) radiation through a proper mask. These gratings are categorized as short period or fiber Bragg gratings (FBGs) and long period gratings (LPGs). In an FBG a narrow band of wavelength is reflected and there is a corresponding drop of intensity in the transmitted spectrum while LPGs work as wavelength dependant loss elements exhibiting multiple loss resonance bands in the transmitted spectrum. Though their ability to filter certain wavelengths was a major attraction in the field of telecommunication, their potential as sensing devices was recognized simultaneously. This is because the filtered wavelength is a function of its effective refractive index as well as the period of the grating and any variation in these parameters results in shift of wavelength which can be detected easily using an optical spectrum analyzer (OSA) or an interrogator. Apart from basic FBG and LPGs there are some other distinct grating types that are formed when deliberate nonuniformity in the refractive index profile is introduced. *Blazed* or *tilted* FBGs are resulted when grating planes are at an angle with the fiber axis and are used mostly for mode conversion. A tilted grating can be designed in a way that its' core mode is coupled with some of the cladding modes so that the Bragg Wavelength becomes a function of ambient refractive index and thus can be used for refractive index sensing. Another type is *chirped* FBG in which the grating period is aperiodic having a monotonic increase/decrease or non-uniformity longitudinally. In this type of gratings each point has different Bragg wavelength and hence its spectrum can be used to monitor a parameter profile by distributed sensing (Kashyap, 2009).

In an FBG, the guided light is scattered by each interface of different refractive index regions in the core and for a wavelength which satisfies Bragg Condition, the scattered light adds up constructively resulting in back reflection with a central wavelength (λ_B) given by

$$\lambda_B = 2n\Lambda \text{ [Bragg Condition]} \quad (1)$$

Where Λ is the pitch or periodicity of the grating, n is the effective refractive index of the core and λ_B is the Bragg wavelength (Kashyap 2009, Othonos & Kallis 1999). Therefore, when light from a broadband source is launched in this FBG the spectral component defined by above equation is missing from the transmitted spectrum. Bragg wavelength is shifted if the effective refractive index, the grating periodicity or both are changed due to some perturbation; in fact both these parameters are directly influenced by strain and ambient temperature with the associated wavelength shift given as

$$\Delta \lambda_B = 2 \left[\Lambda \frac{\partial n}{\partial l} + n \frac{\partial \Lambda}{\partial l} \right] \Delta l + 2 \left[\Lambda \frac{\partial n}{\partial T} + n \frac{\partial \Lambda}{\partial T} \right] \Delta T \quad (2)$$

Where Δl is change in grating length due to strain and ΔT is change in ambient temperature. The first term on the RHS gives strain dependence while the second term

indicates temperature dependence of the Bragg wavelength and an FBG sensor works by monitoring Bragg wavelength shift with one or both of these parameters.

LPGs couple fundamental guided core mode to different cladding modes. The loss resonance wavelength(s) at which this coupling takes place satisfies the phase matching condition i.e.

$$\lambda_i = [n_{eff}^{co} - n_{ieff}^{cl}] \Lambda \quad (3)$$

Where n_{eff}^{co} and n_{ieff}^{cl} are the effective refractive indices of the fundamental core mode and i^{th} cladding mode respectively and Λ is the period of the LPG. Since effective index of a cladding mode is dependent upon the refractive index of the surrounding medium, any change in the latter alters the loss resonance wavelength(s). The influence of refractive index of the surrounding medium on the LPG wavelength(s) is expressed by the following equation,

$$\frac{d\lambda_i}{dn_{sur}} = \frac{d\lambda_i}{dn_{eff}^{cl}} \cdot \frac{dn_{eff}^{cl}}{dn_{sur}} \quad (4)$$

Where, n_{sur} is the refractive index of the surrounding medium.

Apart from the shift in loss resonance wavelengths, the variation in n_{sur} is also reflected as variation in intensity of the loss resonance peak, defined by the overlap integral I given by equation (5),

$$I = \frac{\int_r \int_\phi \psi_{core} \psi_{clad}^* r dr d\phi}{\sqrt{\int_r \int_\phi \psi_{core} \psi_{core}^* r dr d\phi} \sqrt{\int_r \int_\phi \psi_{clad} \psi_{clad}^* r dr d\phi}} \quad (5)$$

Where, ψ s are the electromagnetic field components of the two coupling modes, r and ϕ are radial and azimuthal co-ordinates respectively (Mishra et al 2005). Obviously, any change in cladding field distribution will affect the coupling strength. When the refractive index of the surrounding is varied, it will alter the cladding field distribution and hence the overlap integral. Since effective refractive index of a cladding mode and their coupling efficiency with the fundamental mode is dependent upon the refractive index of the surrounding medium, any change in the latter is easily detected using LPGs. This is the basic principle of an LPG based refractive index and concentration sensor. (James 2003, Patrick & Kersey 1998)

5. Fabrication technology

Direct inscription of submicron periodic pattern in optical fibers puts severe constraints in terms of stability and precision on the grating fabrication techniques. There are only a few methods, namely, the *interferometric*, the *phase mask*, and the *point-by-point* techniques that give consistently good quality gratings. (Othonos 1999)

In our laboratory, fiber gratings are produced by exposing core of a photosensitive fiber (StockerYale Inc.) to intense UV light from a KrF (Krypton Fluoride) excimer laser at 248nm wavelength. The primary acrylate coating is first removed from the fiber section that is to be exposed to UV light, using a thermo-mechanical stripper to avoid mechanical degradation. This uncoated fiber is further loaded onto the fiber mounting stage and an appropriate tension is applied to keep it straight, using load cell. After that the fiber is first made to approach close proximity of the mask within 0.5mm and vertical & horizontal alignments are performed by continuously monitoring on a computer screen. To inscribe FBGs the light from the KrF laser is made incident on the fiber through a phase mask of a period as per the design of the FBG being inscribed and scans on the required length of the fiber to get the FBG inscription of the designed parameters e.g. (a typical value of 1060 nm periodicity phase mask is used in our lab to achieve the peak wavelength in the range of ~1550 nm). To achieve the FBG with more than 90% reflectivity, 7-8 scans were applied. For LPG fabrication point-by-point method is used to expose fiber core to laser radiation. To monitor the FBG parameter within the appropriate design, optical spectrum analyzer with broadband ASE (**Amplified Stimulated Emission**) source is used while for LPGs white light source is employed. Figure 2 shows the experimental setup for grating fabrication.

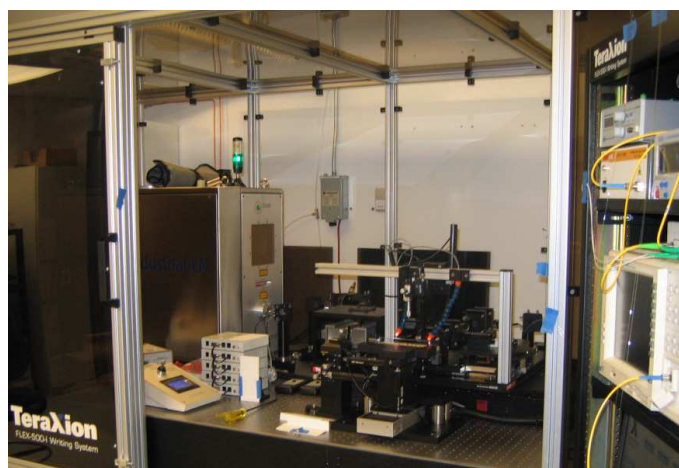

Fig. 2. Grating fabrication set up

To protect the FBG from external environment and to provide mechanical strength, the stripped fiber section is immediately re-coated with acrylate while LPGs are left uncoated so that they remain sensitive to external refractive index. Care should be taken to keep the bare LPGs well protected; they should be either fixed in a working glass cell or kept properly covered when not in use. Finally, for stabilization of grating properties over long period of time, thermal annealing of inscribed gratings at high temperature ($>150\text{ }^{\circ}\text{C}$) is carried out.

6. Current research scenario

The multiplexing, multi-parameter and minimally invasive sensing capabilities even in high electric/magnetic field environments of fiber grating sensors make them befitting for

various applications in healthcare as evident by past and ongoing research activities all over the world. Some areas of current activities are described briefly in subsequent sub-sections.

6.1 Biomechanics

Biomechanics involves application of engineering mechanics to biological systems to better understand them and make use of conventional electrical strain gages (ESGs) as a tool. These ESGs, considered gold standard for strain measurement, consist of metallic parts and it is difficult to make them adhere on the surface of a bone or other biological tissues. Besides, working of an ESG depends upon measuring electric resistance that varies with applied strain and so it is not suitable in strong electric and magnetic field environment associated with medical appliances. Moreover, they cannot be made completely biocompatible. Fiber gratings have an edge over the conventional electrical gages even for *in-vivo* applications because they have smaller risk for infection and can also be used even on curved surfaces or in locations where use of a conventional gage is technically and medically not feasible.

A temperature independent array of FBGs with proper design can be used as pressure sensor to measure muscular strength of hands or weight profile of patients when used under foot. In a study started almost a decade earlier, FBG pressure sensors embedded in Carbon Fiber reinforced material were designed and investigated by a research group in Singapore for monitoring the foot pressure of diabetic patients (Hao et al 2003). These sensors give better results in terms of sensitivity, cost and compactness as compared to conventional foot pressure sensing systems. This concept along with development of multiple neural networks for continuous monitoring of various parameters simultaneously can be used for *human gait analysis*. Gait analysis is important for patients with cerebral palsy, neuromuscular disorders or diabetes and many hospitals worldwide now have gait labs both to design treatment plans, and for follow-up monitoring. Existing systems of gait analysis use large numbers of sensors or complex imaging systems, whereas several FBGs on a single strand of fiber with one interrogation unit can be embedded within materials forming a surface without loss of material strength. Recently, FBG sensors have been investigated for distributed tactile sensing (Cowie et al 2006, 2007) in a grid arrangement along with a neural network to detect the position and shape of a contacting load simultaneously in real-time.

Multiple FBG sensors in a single fiber can be bonded at strategic locations on the patients' bed to continuously monitor their movements from a remote station. The concept of a smart bed is under investigation in Singapore (Hao et al 2010). A series of 12 FBG sensors underneath the patient's mattress with suitable algorithm give pressure profile and respiratory rate of the patient while another set of gratings placed on top of the mattress detect heart rate. Existing methods require different techniques for each individual parameter while this single system shown schematically in figure 3, can monitor respiratory rate, heart rate, pressure points and occupancy of patient on bed in a continuous, non-intrusive and robust manner.

An ongoing project entitled, "**Intelligent adaptable surface with optical fiber sensing for pressure- tension relief**" (IASIS) of European Commission is incorporating FBG-based 2D

and 3D sensing systems for utilization in “smart” fiber-based Human Machine Interfaces (HMI) employed in clinical beds, amputee sockets and wheelchair seating systems, targeting pressure ulcer and wound treatment. (Pleros et al 2009).

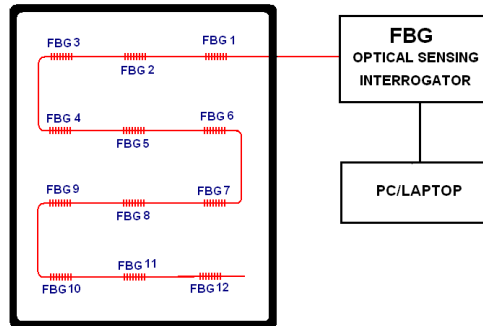

Fig. 3. Schematic of the FBG sensor array for smart bed

Recently some studies on the possible use of FBG as a strain gage in bones have been undertaken. Although *in-vivo* strain measurement in humans is not very common, the researchers at Hadassah University Hospital, Israel have reported use of instrumented bone staples made of electrical strain gages in some volunteers (Milogram 2000, 2003). Talaia et al (2007) have first reported use of FBG sensor array to study strains in fracture fixation of synthetic femur. As strain measurement on bone plates using ESG is technically difficult and not feasible, FBGs are good alternative to assess the stiffness of callus formation of fractured bones. Use of FBG sensors in place of ESGs have been validated to measure deformation in human cadaver femur bone specimen under *in-vitro* loading condition (Fresvig et al 2008). The effect of **decalcification** on strain response of a goat tibia was investigated *in-vitro* using FBG sensors by our group (Mishra et al 2010). In the investigation, two tibia bone samples were taken from the same animal. The FBG sensor was directly bonded onto the surface at the midpoint of the bone shaft, which is the most vulnerable point, using standard cyanoacrylate adhesive and cured properly. One sample was decalcified in gradual steps while the other was kept in saline solution for a comparative study. Both the bone samples were strained by using three-point bending technique and corresponding Bragg wavelength shifts were recorded. Strain response of the decalcified and untreated bones was studied concurrently to monitor the effects of calcium loss and that of degradation with time. The strain generated for the same stress increased with greater degree of decalcification e.g. calcium loss of even 0.3906 gm (treatment 1) resulted in 1.3 times/ 24% more strain for the same load while calcium loss of 1 gm resulted in 50% increase in strain and when calcium loss was 2.78 gm the increase in strain reached more than 2000% i.e. 22 times more strain as compared to that before decalcification. Figures 4a & 4b show the schematic of the experimental setup developed and the results obtained respectively. The Dexa results of bone samples matched with our results for mineral loss.

It is possible to measure strain less than 5 micro-strains accurately using this sensing technique, which can be indicative of the onset of decalcification. The objective of this

investigation was to develop a different, efficient and safe method to estimate calcium levels in bones. The small size of fiber can be utilized to make strain staples much smaller than the existing ones so that it can be implanted using *minimally-invasive* surgical method, or, as this technology is still developing it may advance into *non-invasive* method in future.

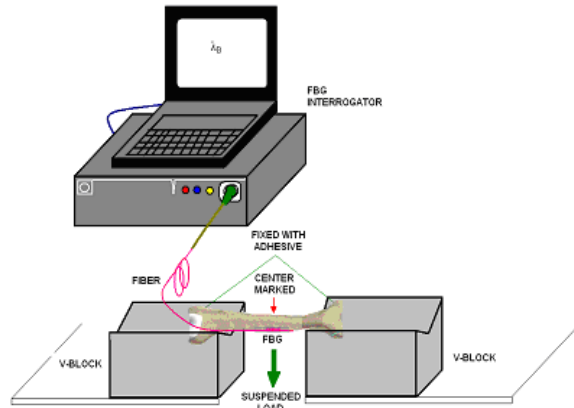

Fig. 4a. Schematic Illustration of the Experimental Set up

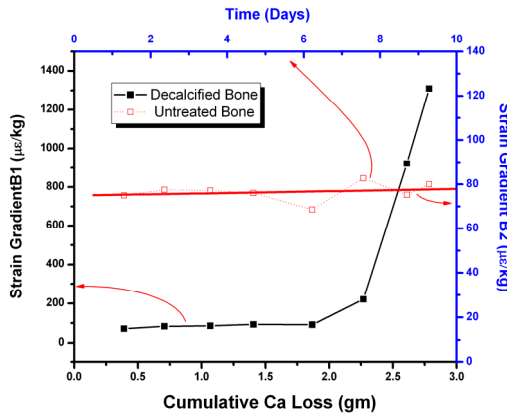

Fig. 4b. The Results of Bone Decalcification Study

First application of embedded FBG sensors in dental biomechanics was reported (Tjin et al 2001) to monitor the force and temperature as a function of time in dental splints used by patients with obstructive sleep apnoea. This monitoring gives a clear indication of the compliance of the patient with regard to the proper usage of splint which is necessary for its effectiveness. In another type of investigation FBGs written in polarization maintaining fibers were used to monitor the drying of dental cement and the corresponding stress build-up (Ottevaere et al 2005). To measure strain at a mandible surface caused by impact loads on dental implants, an FBG sensor was employed by JCC Silva et al (2004) on a dried cadaveric

mandible showing the feasibility of using FBG to monitor dynamic strain in complex biomechanical systems. A research group in Portugal has applied FBG sensors to assess the performance of dental implant system by measuring static and dynamic bone strains around it. Conventional techniques can not be used to measure strains inside bones (Schiller et al 2006). This study can lead to significant improvement in the design of dental implants.

Now-a-days, the use of custom-made mouthguards as preventive measures for persons participating in sports activities is being encouraged as they have an injury-preventing ability. To evaluate the performance characteristics of such mouthguards, no standard technique exists till date. A unique experimental scheme utilizing fiber Bragg gratings (FBGs) as distributed strain sensors is proposed and investigated by our group to estimate impact absorption capability of custom-made mouthguards. In the scheme, a pendulum based fixture with interchangeable impact load e.g. cricket, hockey and steel balls, was custom made for the investigation. Two sets of FBGs were used; one at the mouthguard surface and the other at similar position on a jaw model. The fixture was used to simulate impact using different balls released from varying angles and Bragg wavelength shifts of FBGs at mouthguard and that at the jaw model were recorded. Figures 5a & 5b show photograph of the jaw model, mouthguard with pendulum setup and change in FBG spectrum due to impact. It is obvious from the FBG response shown in figure 5b that for the same impact there is no detectable change in the Bragg wavelength of the FBG bonded on



Fig. 5a. Photograph of the Experimental Set up for Mouthguard Experiment

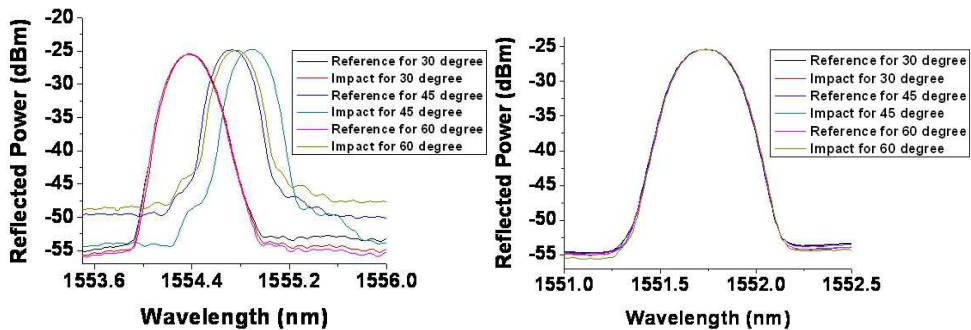

Fig. 5b. Spectral shift due to Ball Impact of FBG Sensors fixed on Mouthguard and on Jaw Model

the jaw model while FBG on the mouthguard has shown large wavelength shift with each impact. Relative Bragg wavelength shift with respect to each impact load determines the protection capability of the mouthguard. Due to multiplexing capability of FBGs, it is possible to fix multiple sensors in series at various points of mouthguard and denture to evaluate the effect of a single impact on different locations simultaneously. Impact tests on various locations can detect the vulnerable points where the mouthguard is less protective.

Through such studies it will be possible to quantify the level of protection and hence to predict the required modifications in the mouthguard. This research work thus, is important for the establishment of guidelines for design of safer mouthguards. (Tiwari et al 2011)

J Paul et al (2005) had suggested use of five FBGs written at different wavelengths to measure **handgrip strength** through a grip holder. Handgrip strength monitoring is rated as one of the top ten fitness tests to evaluate different physical and functional disorders related to healthcare. The conventional methods (dynamometer) are rough, uncomfortable and do not provide individual finger strengths; thus not suitable especially for rehabilitation programs.

Researchers at Nanyang Technological University, Singapore have reported an FBG based sensor in instrumented tibial spacer (ITS) to correct **misalignment during total knee replacement** surgery. The sensor, comprising of optical fibers with sampled chirped gratings inscribed on each fiber to generate a pressure profile, was embedded in a fiber-reinforced composite. During a total knee joint replacement procedure, the ITS sensor can slide in place of the prosthetic spacer. The femur can be rolled over the ITS sensor and the alignment checked from the pressure map displayed. Any misalignment can be corrected with repeated checking. After the measurements are taken and the required alignment achieved, the ITS sensor can be replaced by the actual tibial prosthetic spacer and the knee joint can be sutured (Mohanty et al 2007).

Methods were developed by Dennison et al 2007 to measure **intervertebral disc pressure** response to compressive load in five lumbar functional spine units, using FBG in a patented configuration. The pressure measurement with FBGs is less disruptive than the existing techniques. In an improved configuration FBG sensor placed in silicone filled needle were applied to intervertebral disc pressure measurements in a cadaveric porcine functional spinal unit and the results were in agreement to those obtained with the standard strain gage sensor. (Dennison et al 2009 1 &2).

Investigative study of FBG sensor for in-vitro **biomechanical properties of porcine tendons** was reported by Miloslav Vilimek (2008). The **tendon force** was calibrated using Bragg wavelength measurement of the FBG bonded on the tendon with applied load. FBG was used as displacement sensor on cadaver Achilles tendon and knee ligament for **movement measurement of tendons and ligaments** (Ren et al 2007). Study of change in length of ligament under various strain conditions is important as ligaments experience much higher strain as compared to bone for same loading. The FBG sensors exhibited higher sensitivity, low noise and same accuracy as compared to stereo-optic measurement which are though non-invasive have limitations of poor accuracy and high noise level.

In a very recent development a research group from Portugal has investigated osteoblastic **biocompatibility** of optical fibers and stability of the properties of FBG sensors for their in-vivo usage. (Carvalho et al 2011) The study analysed the behaviour of human bone marrow

cells cultured in osteogenic-induced conditions over an optical fiber and in parallel, the sensing capability of FBG sensors throughout the culture time was assessed. The results showed that in addition to the excellent osteoblastic cytocompatibility, FBGs maintained the physical integrity and functionality, as their sensing capability was not affected throughout the cell culture period. Results suggest the possibility of in-vivo osseointegration of the optical fiber/FBGs anticipating a variety of applications in bone mechanical dynamics.

6.2 Biosensors

The ability of LPGs to detect refractive index variation in their vicinity has great potential for detection of clinical analytes and can be made to detect extremely low concentrations. An LPG with an immobilized antibody film on its surface is a very efficient device to detect target antigen bonding to this film by means of refractive index change associated with the process. The advantage of using LPG is that it is a direct and label free sensor which does not require any additional reagents to visualize binding. Figure 6 indicates the basic experimental set up for an LPG based biosensor. DeLisa et al (2000) have first reported use of LPG as biosensor for detection of human IgG by specific antibody-antigen binding with immobilized goat anti-human IgG antibody on the chemically treated surface of LPG. The system could work for antigen solution concentration between 2-100 $\mu\text{g mL}^{-1}$

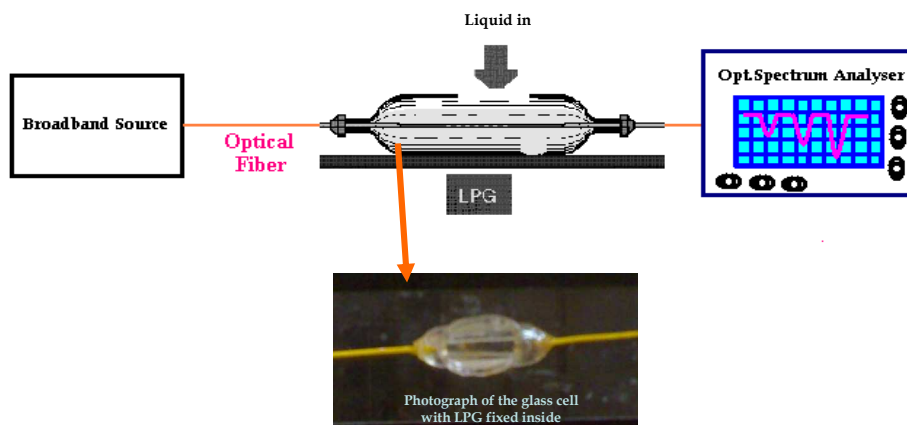

Fig. 6. The Experimental set up for an LPG Based Biosensor

Luna Analytics Inc. (Blacksburg, VA) had recently started developing an LPG based biosensor system though the product is yet to be commercialized. The sensitivities of these LPG sensors were found to be comparable to those of ELISA techniques (Baird & Myszkka 2001, Pennington et al, 2001). LPG sensors have also been used for monitoring microbial activity (Carville, 2002]. Higher sensitivity in LPG sensors can be achieved by using gratings with smaller period or reduced- diameter cladding (Patrick & Kersey, 1998, Shu et al 2002). Chen et al (2007) have verified high sensitivity of smaller period LPGs and their reusability by detecting DNA hybridization.

In normal FBGs as the optical signals are confined to the fiber core regions they are insensitive to external refractive index variation, but they can be made sensitive either by writing tilted grating or etching the cladding part. A Bovine Serum Albumin (BSA) immobilized tilted FBG based immunosensor was reported recently to detect anti-BSA (Maguis et al 2008). In another approach, highly sensitive etched FBG sensors have been demonstrated by Chryssis et al (2005) to detect hybridization of single strand DNA. All the FBG based biosensing research is currently at the level of laboratory investigations only as it requires either specially designed or etched FBGs that are difficult if not impractical to fabricate and expensive as compared to LPGs.

FBG/LPG sensor systems can be incorporated with the microchips to detect chemical changes in nanolitre amounts of liquids and have the potential of being part of a μ -TAS (micro total analysis system) or **lab-on-chip**. Miniaturization and integration of light sources, sensors, detectors, as well as the corresponding signal processing is required for implementation of these concepts in a practical analysis system.

6.3 Cardiology

Flow-directed thermodilution catheters with conventional thermistor and thermocouple devices were commercially available for many years to monitor heart efficiency. However, as these sensors are electrically active they are not appropriate for use in a number of medical applications, especially in high magnetic fields associated with NMR machines. In a study, Rao et al (1997) and coworkers in UK used a catheter with FBG temperature sensor in place of thermocouple in a test rig set up to simulate blood flow in the heart with a peristaltic pump to simulate the heart pump. The results were found to be in good agreement with the electrical sensor with smoother temperature profile.

In 2005, Deniz Gurkan et al had proposed FBG sensor to monitor heartbeat using sound pressure for possible application in ballistocardiography (BCG). For a proof-of-concept demonstration, an FBG sensor was glued to vibrating membrane of a subwoofer of a speaker set. Using recordings of various heartbeat sounds, spectral changes were monitored and analyzed to extract all relevant information. They predicted that in a real life scenario, the FBG would be placed on the patient's body in the same way as a stethoscope to detect any abnormalities in the heart muscle more efficiently. FBG for blood pressure monitoring had been reported by Brakel et al (2004) where they had proposed FBG Fabry-Perot interferometer (FBGI) as a sensor configuration to detect strain resulting from blood pressure applied to the walls of an artery situated near the patient's skin. In an investigation they demonstrated an optical blood pressure manometer that not only measured accurate systolic and diastolic blood pressures once it was calibrated, but also provided a continuous pressure waveform quite comparable with conventional Sphygmomanometer pulse wave velocity system readings.

FBG sensors, being small and light, have particular advantages for use in endoscopic applications and offer the possibility of being used in conjunction with MRI scanning, thus opening up an opportunity for performing surgery with continual scanning. FBGs can be mounted on the tip of an intra-aortic catheter that serves as a laser-ablation delivery probe for the treatment of atrial fibrillation. The FBGs can give real-time,

objective measure of tip-to-tissue contact force during the catheter ablation procedure. Force control is essential for delivering appropriate laser ablation pulses needed to produce lesions that are induced in the heart walls. If the contact force is too great, the catheter tip may perforate the heart wall and if it is too light, the procedure may be ineffective. Such force-sensing catheters with accompanying system have undergone extensive pre-clinical and clinical validation in the United States & Europe and are currently undergoing precertification trials⁵.

6.4 Gynecology

Measurement of the pelvic muscles pressure was demonstrated using FBG based intravaginal probe in Portugal (Ferreira et al 2006). This measurement is essential for understanding pelvic floor disorders pathophysiology. The system was tested in a sample of patients with known pelvic floor disorders and the preliminary investigations indicated good sensitivity to radial pressure changes within the pelvic floor due to normal breathing cycle of the patient.

6.5 High intensity ultrasonic field measurements

High-intensity ultrasonic fields are used in various medical applications like ultrasound surgery, hyperthermia, lithotripsy and even diagnostic ultrasound. Thus safety concerns demand their accurate level assessment. The conventional detection techniques utilizing piezoelectric devices are susceptible to electromagnetic interference and signal distortion. Fisher et al (1998) demonstrated that FBG sensors can be used for this purpose by implementing them to detect signals of frequencies in the range of 500 kHz and 4 MHz.

6.6 Respiration monitoring system

A temperature independent FBG or LPG can be designed for non-invasive measurement of the torso movement during respiration ventilatory movements to understand respiratory physiology and to monitor the lung function. In a preliminary work, Günther Wehrle et al in 2001 employed FBG sensor on the chest using an elastic belt to hold it in place to detect thorax movements during artificial ventilation, even in the presence of electrical bursts caused by electrodes situated on the chest. Expansion of the thorax cage during respiration was accordingly transmitted to the sensor grating and caused it to deform under the strain. First application of a multiplexed LPG array on curvature sensing garment used to monitor the thoracic and abdominal movements of a human during respiration was reported by T. Allsop et al 2003, 2007. They have shown that, it is possible to generate a geometric profile of the chest and abdomen in three dimensions with an array of 20 sensors.

6.7 Temperature monitoring

Thermal therapy involves destruction of redundant tissue by heating or freezing without surgery. Examples of thermal therapies include treatment of benign prostatic diseases, ablation therapy of cardiac arrhythmia, microwave induced hyperthermia for radio therapy

⁵ <http://www.endosense.com/home.html>

in the cancer treatment, during which temperature of both diseased and normal tissues should ideally be monitored. Most temperature sensors measure temperature at one point only, whereas FBG sensors because of their multiplexing capability provide temperature distribution during thermal treatment using one probe only. Temperature monitoring of a patient during MRI procedure is crucial in general and in particular to ensure that the implantable devices do not heat up under strong fields of MRI. An FBG probe can be placed inside a NMR machine with high magnetic field for remote temperature measurement.

An FBG based temperature profile monitoring system was first proposed by researchers from UK and Australia using four strain-free FBG array that meets the established medical requirements and tested the feasibility of FBG temperature probe inside a NMR machine with high magnetic field and established its working (Rao et al 1997, 1&2). The first *in-vivo* trials of such temperature probes incorporating five FBGs along a single fiber were undertaken successfully at the Cancer Research Institute in Perth, Australia by the same group (Webb et al 2000) on rabbits undergoing hyperthermia treatment of the kidney and liver via inductive heating of metallic implants. A distributed FBG sensor system was tested effectively in temperature range of -195.8°C to 100°C for *in-vivo* use during freezing of porcine liver, for their mechanical stability and MR compatibility (Samset et al 2001).

FBGs are very useful in cryosurgery for localized cancer treatment, where precision of millimeters matters. It is very critical to monitor exact temperature profile throughout surgical procedure to ensure adequate freezing (-40°C) in the cancerous region but preventing low temperatures in the attached nerve fibers, blood vessels or nearby organs for their safety. An FBG based re-usable multi-point temperature monitoring system was developed recently which can record temperatures in a continuum of either four points at 10-mm intervals, or eight points at 5-mm intervals (Gowardhan & Greene 2007, Polascik & Mouraviev 2008).

6.8 FBG based manometry catheter

A research group from Australia has demonstrated multi-element catheter using FBG pressure sensor in *in-vivo* trials in the human oesophagus for diagnosis of gastrointestinal motility disorders (Arkwright et al 2009). The FBG based catheters had an outer diameter of less than 3 mm and were very flexible in comparison to solid state catheters, allowing easy nasal intubation and relative comfort for the patient during subsequent clinical diagnosis. Also, due to multiplexing capability of FBGs a large number of sensors can be accommodated in a single fiber thus making it possible to extend the total span of the sensing region, with no change in the catheter size. For validation, 10 healthy volunteers were intubated via the nose with both catheter assemblies and asked to perform series of controlled water swallows. The results were directly compared with a commercially available solid state catheter and largely equivalent response was obtained.

6.9 Smart clothing

Smart clothings have the capability to sense stimuli from the environment, to react and adapt to them. Due to their small size and flexibility fiber optic sensors can be woven into the textile and be an integral part of the smart system. This type of wearable and smart

textile is useful not only for patient health monitoring but also for soldiers in battlefields, people in sports and even for general safety of public. In a collaborative work 10 expert groups from 5 EU countries have initiated a novel project, i.e. *Optical Fiber Sensors Embedded into Technical Textile for Healthcare* (OFSETH) to create smart wearable textiles with FBG along with other optical devices for measurements of various vital parameters⁶. Though preliminary experiments with the textile containing FBGs had been undertaken further investigations are needed for practical implementation of smart textile concept in terms of better integration of the fiber with textile, of different patient profiles and overall performance in real environment. (Grillet et al 2008)

6.10 Robotic surgery

A force sensing robot fingers using embedded FBG sensors and shape deposition manufacturing have been demonstrated recently (Park et al 2008). With their very small size and highly precise real-time measurements FBG sensors have the potential to be a part of surgical robot. Shape-sensing systems can be created by using arrays of FBGs distributed along multicore, singlemode fibers that will help determine the precise position and shape of medical tools and robotic arms used during minimally invasive/robotic surgery.

6.11 Optical Coherence Tomography (OCT)

OCT is an upcoming technology for non-invasive cross-sectional imaging in biological systems with a great potential for morphological assessment of various tissues. OCT acquires very high-resolution images through the detection of backscattered near infrared light with the potential to identify a wide range of pathologies in-vivo. Clinical applications of OCT are constrained by its limited penetration depth in tissue and miniaturized fiber-optic probes are used to image deeper within the body. (McLaughlin & Sampson 2010)

FBGs with precise Bragg wavelength, narrow spectral bandwidth less than 0.1 nm and high reflectivity are being applied in the OCT systems to calibrate and align the custom-made spectrometer for the spectral-domain optical coherence tomography (SD-OCT) system operating in the 1300-nm wavelength range. The calibration and characterization protocol was presented and investigated very recently. (Eom et al 2011)

7. Conclusion

Fiber grating based sensors and devices are just beginning to tap the vast opportunity for diagnostics to help in therapeutics as indicated by the large number of ongoing research & development activities mentioned in the previous section. They are enabling acquisition of analytical results on the patient's bedside within a few minutes minus the electromagnetic or other interferences. With the development of technology the possibility of cheaper and portable interrogator systems is within reach and the cost of grating fabrication would come down for bulk fabrication. Also, acceptance by the end users will follow only after the researchers are able to prove that this technology is better than the existing ones through

⁶ <http://www.ofseth.org>

intensive collaborative efforts. In view of these aspects, it can be predicted that this rapidly evolving technology shall provide much better and effective solutions for various biomedical applications and has the potential to be an integral part of the futuristic healthcare systems.

8. Acknowledgment

The authors acknowledge Dr Pawan Kapur, Director CSIR-CSIO for his motivation and encouragement. They thank Mr SC Jain, Mr Umesh Tiwari and Mr GC Poddar from CSIR-CSIO, Chandigarh for their help and cooperation.

9. References

- Allsop T., Earthrowl-Gould T., Webb D. J. & Bennion I. (2003) Embedded progressive-three-layered fiber long-period gratings for respiratory monitoring, *J Biomed Opt.* vol.8(3): 552-558
- Allsop T., Carroll K., Lloyd G., Webb D.J., Miller M., Bennion I. (2007) Application of long-period-grating sensors to respiratory plethysmography, *J Biomed Opt.* vol.12 (6): 064003.
- Arkwright J.W., Blenman N.G., Underhill I.D., Maunder S.A., Szczesniak M.M., Dinning P.G. & Cook I.J. (2009) In-vivo demonstration of a high resolution optical fiber manometry catheter for diagnosis of gastrointestinal motility disorders, *Opt Express*, vol.17(6): 4500-4508.
- Baird C.L. & Myszka D.G. (2001) Current and emerging commercial optical biosensors, *J. Mol. Recognit.* vol.14: 261-268
- Brakel A.V, Swart P.L., Chtcherbakov A.A. & Shlyagin M.G.(2004) Blood pressure manometer using a twin Bragg grating Fabry-Perot interferometer, *Photonics Asia Conference on Advanced Sensor Systems and Applications II*, Beijing, *Proc. SPIE* vol.5634:595-602
- Carvalho L., Alberto N.J., Gomes P.S., Nogueira R.N., Pinto J.L., Fernandes M.H. (2011) In the trail of a new bio-sensor for measuring strain in bone: osteoblastic biocompatibility, *Biosens Bioelectron.* vol. 26(10): 4046-52
- Carville D.G.M. (Jan 2002) Fiber optics for the detection of clinical analytes, *IVD Technology*. <http://www.ivdtechnology.com/article/fiber-optics-detection-clinical-analytes>
- Chen X., Zhang L., Zhou K., Davies E., Sugden K., Bennion I., Hughes M. & Hine A. (2007) Real-time detection of DNA interactions with long period fiber-grating-based biosensor, *Opt Lett*, vol. 32(17): 2541.
- Chryssis A.N., Saini S.S., Lee S.M., Yi H., Bentley W.E. & Dagenais M. (2005) Detecting Hybridization of DNA by Highly Sensitive Evanescent Field Etched Core Fiber Bragg Grating Sensors, *IEEE J. Sel. Top. Quantum Electron*, vol.11 (4): 864-872.
- Cowie B.M., Webb D.J., Tam B., Slack P. & Brett P.N. (2006) Distributive Tactile Sensing using Fibre Bragg Grating Sensors for Biomedical Applications, *Proc. SPIE* vol. 6191: 249.
- Cowie B.M., Webb D.J., Tam B., Slack P. & Brett P.N. (2007) Fibre Bragg Grating Sensors for distributive Tactile Sensing, *Meas Sci Technol*, vol.18: 138-146.

- Davis, S. D., Gibbons, D. F., Martin, R. L., Levitt, S. R., Smith, J. and Harrington, R. V. (1972) Biocompatibility of ceramic implants in soft tissue, *Journal of Biomedical Materials Research*, vol. 6: 425-449
- DeLisa M.P., Zhang Z., Shiloach M., Pilevar S., Davis C.C., Sirkis J.S. & Bentley W.E. (2000) Evanescent Wave Long-Period Fiber Bragg Grating as an Immobilized Antibody Biosensor. *Anal. Chem.*, vol.72: 2895-2900
- Dennison C.R., Wild P.M., Wilson D.R., Cripton P.A. & Dvorak M.F.S. Pressure Sensor for Biological Fluids and use thereof, Patent application: WO 2007/09/5752.
- Dennison C. R., Wild P. M., Byrnes P.W.G., Saari A., Itshayek E., Wilson D. C., Zhu Q. A., Dvorak M.F.S., Cripton P.A. & Wilson D.R. (2008) Ex vivo measurement of lumbar intervertebral disc pressure using fiber-Bragg gratings, *J Biomech*, vol.41(1): 221-225.
- Dennison C.R., Wild P.M., Wilson D.R., Cripton P.A. (2008) A minimally invasive in-fiber Bragg grating sensor for intervertebral disc pressure measurements, *Meas. Sci. Technol*, vol.19 :085201
- Eom T.J., Ahn Y.C., Kim C. S. & Chen Z. (2011) Calibration and characterization protocol for spectral-domain optical coherence tomography using fiber Bragg gratings, *J. Biomed. Opt.* vol.16(3): 030501 1-3
- Ferreira L.A., Araújo F.M., Mascarenhas T., Natal Jorge R.M., Fernandes A.A. (2006) Dynamic assessment of women pelvic floor function by using a fiber Bragg grating sensor system, *Proc. SPIE* vol. 6083: 60830H-1.
- Fisher N.E., Webb D.J., Pannell C.N., Jackson D.A., Gavrilov L.R., Hand J.W., Zhang L. & Bennion I. (1998) Ultrasonic hydrophone based on short in-fiber Bragg gratings, *Appl Opt.* vol. 37 (34): 8120-28.
- Fresvig T., Ludvigsen P., Steen H. & Reikeras O. (2008) Fiber optic Bragg grating sensors: An alternative method to strain gages for measuring deformation in bone, *Med Eng Phys* vol. 30: 104-108
- Gowardhan B. & Greene D. (2007) Cryotherapy for the prostate: an *in vitro* and clinical study of two new developments; advanced cryoneedles and a temperature monitoring system, *BJU Int.* vol.100(2): 295-302
- Grillet A., Kinet D., Witt J., Schukar M., Krebber K., Pirotte F. & Depré A. (2008) Optical Fiber Sensors Embedded Into Medical Textiles for Healthcare Monitoring, *IEEE Sensors J*, vol.8: 1215.
- Gurkan D., Starodubov D. & Yuan X. (Nov. 2005) Monitoring of the heartbeat sounds using an optical fiber Bragg grating sensor, in *Proc. 4th IEEE Conf. Sensors*, Irvine, CA,
- Hao J.Z., Tan K.M., Tjin S.C., Liaw C.Y., RoyChaudhuri P., Cuo X. & Lu C., (2003) Design of a foot-pressure monitoring transducer for diabetic patients based on FBG sensors, *LEOS 2003. The 16th Annual Meeting of the IEEE*, 23-24.
- Hao, J., Jayachandran, M., Kng, P., Foo, S., Aung Aung, P., and Cai, Z. (2010). FBG-based smart bed system for healthcare applications. *Frontiers of Optoelectronics in China* 3, 78-83.
- Hecht J. (1999) *City of Light: The Story of Fiber Optics*, Oxford University Press, New York,
- James S.W. & Tatam. R.P. (2003) Optical fibre long-period grating sensors: Characteristics and application, *Meas. Sci. Technol.* vol.14: R49-R61

- Kashyap R. *Fiber Bragg Gratings*, second edition (Academic Press, London), 2009.
- Katzir A. (1989) *Optical Fibers in Medicine*, *Scientific American*, 120
- Maguis S., Laffont G., Ferdinand P., Carbonnier B., Kham K., Mekhalif T. & Millot M.C. (2008) Biofunctionalized tilted Fiber Bragg Gratings for label-free immunosensing, *Opt Express*, vol.16(23) :19049.
- Majumder M., Gangopadhyay T.K., Chakraborty A.K., Dasgupta K.& Bhattacharya D.K. (2008) Fibre Bragg gratings in structural health monitoring—Present status and applications, *Sens. Actuators, A* vol.147: 150–164.
- McLaughlin R.A. & Sampson D.D. (2010) Clinical applications of fiber-optic probes in optical coherence tomography, *Optical Fiber Technology* vol.16: 467–475
- Milgrom C., Finestone A., Simkin A., Ekenman I., Mendelson S., Millgram M., Nyska M., Larsson E. & Burr D. (2000) In vivo strain measurements to evaluate the strengthening potential of exercises on the tibial bone, *J Bone Joint Surg* vol. 82-B: 591-4.
- Milgrom C., Finestone A., Segev S., Olin C., Arndt T. & Ekenman I. (2003) Are overground or treadmill runners more likely to sustain tibial stress fracture?, *Br J Sports Med* vol.37: 160–3.
- Miloslav V. (2008) Using a fiber Bragg grating sensor for Tendon force measurements, *J Biomech*, 41(S1).
- Mishra V., Singh N.& Kapur P. (2009) Fiber Optic Sensors Technology in Medicine, in: D.V. Rai, Raj Bahadur (Eds.), *Trends in Medical Physics and Bio medical Instrumentation*, New Era International Imprint, India, pp. 225-242
- Mishra V., Singh N., Jain S. C., Kaur P., Luthra R., Singla H., Jindal V. K. & Bajpai R. P. (2005) Refractive index and concentration sensing of solutions using mechanically induced long period grating (LPG) pair, *Opt Eng*, vol. 44(9): 094402-1-4.
- Mishra V., Singh N., Rai D.V., Tiwari U., Poddar G.C., Jain S.C., Mondal S.K. & Kapur P. (2010) Fiber Bragg Grating Sensor for Monitoring Bone Decalcification, *Orthop Traumatol Surg Res*, vol. 96: 646- 651
- Mishra V., Singh N., Tiwari U.& Kapur P.(2011) Fiber Grating Sensors in Medicine: Current and Emerging Application, *Sens. Actuators, A*. vol.167: 279–290,
- Mohanty L., Tjin S.C., Lie D., Panganiban S.E.C., Chow P. (2007) Fiber grating sensor for pressure mapping during total knee arthroplasty, *Sens. Actuators, A*. vol.135(2): 323-328
- Othonos A. & Kalli K. (1999) *Fiber Bragg Gratings: Fundamentals and Applications in Telecommunications and Sensing*, Artech House, London.
- Ottevaere H., Tabak M., Fernandez A.F., Berghmans F.& Thienpont H. (2005) Optical fiber sensors and their application in monitoring stress build-up in dental resin cements, *Optical Fibers: Applications*, Warsaw, Proc. SPIE, vol. 5952: 204-216,
- Patrick H.J. & Kersey A.D. (1998) Analysis of the response of long period fiber gratings to external index of refraction, *J. Lightwave Technol*, vol.16: 1606.
- Park Y.L., Ryu S.C., Black R.J., Moslehi B. & Cutkosky M.R. (2008) Fingertip Force Control with Embedded Fiber Bragg Grating Sensors, *Proc IEEE International Conference on Robotics and Automation*, 3431 - 3436

- Paul J., Zhao L., & Ngoi B.K.A. (2005) Fiber-optic sensor for handgrip-strength monitoring: conception and design. *Appl Opt*, vol.44 (18): 3696-3704.
- Pennington C., Jones M., Evans M., VanTassell R. & Averett J. (2001) Fiber-optic-based biosensors utilizing long period grating (LPG) technology, *Proc. SPIE* vol. 4255: 53.
- Pleros N., Kanellos G.T. & Papaioannou G. (2009) Optical Fiber Sensors in Orthopedic Biomechanics and Rehabilitation, *Proc. 9th International Conference on Information Technology and Applications in Biomedicine, ITAB 2009*, Cyprus, 1-4.
- Polascik T.J. & Mouraviev V. (2008) Focal therapy for prostate cancer. *Curr Opin Urol* vol.18: 269-274.
- Rao Y.J. (1997) In-fibre Bragg grating sensors, *Meas. Sci. Technol*, vol. 8: 355-375
- Rao Y.J., Jackson D.A., Webb D.J., Zhang L. & Bennion I. (1997) In-fiber Bragg grating flow-directed thermolulution catheter for cardiac monitoring, *Proceedings of the Optical Fiber Sensors Conference (OFS-12)*, Williamsburg, VA, USA 354-357.
- Rao Y.J., Hurlle B., Webb D.J., Jackson D.A., Zhang L., Bennion I. (1997) In-situ temperature monitoring in NMR machines with a prototype in-fiber Bragg grating sensor system, *Proceedings of the Optical Fiber Sensors Conference (OFS-12)*, Williamsburg, VA, USA, 646-649.
- Rao Y.J., Webb D.J., Jackson D.A., Zhang L., Bennion I. (1997) In-fiber Bragg grating temperature sensor for medical applications, *J. Lightwave Technol*, vol.15(5): 779-785.
- Ren L., Song G., Conditt M., Noble P. & Li H. (2007) Fiber Bragg grating displacement sensor for movement measurement of tendons and ligaments, *Appl. Opt.* vol.46: 6867-6871
- Russell P. S. J. (2003) Photonic crystal fibers, *Science*, 299 358-362.
- Samset E., Mala, T. Ellingsen R., Gladhaug I., Søreide O. & Fosse E. (2001) Temperature measurement in soft tissue using a distributed fibre Bragg grating sensor system. *Min Invas Ther & Allied Technol*, vol.10(2): 89-93
- Schiller M. W., I. Abe, P. Carvalho, P. Lopes, L. Carvalho, R. N. Nogueira, J. L. Pinto, J. A. Simões, On the Use of FBG Sensors to Assess the Performance of a Dental Implant System, *Proceedings of the Optical Fiber Sensors Conference (OFS-2006)*, (Oct. 23-27 2006) Cancún, México. ThE77.
- Shu X., Zhang L. & Bennion I. (2002) Sensitivity Characteristics of Long-Period Fiber Gratings, *J. Lightwave Technol*, vol. 20(2): 255-266
- Silva J.C.C., Carvalho L., Nogueira R.N., Simões J.A., Pinto J.L. & Kalinowski H.J. (2004) FBG applied in dynamic analysis of an implanted cadaveric mandible, *Second European Workshop on Optical Fibre Sensors (Santander, Spain)*, *Proc. SPIE* 5502 : 226-229
- Talaia P.M., Ramos A., Abe I., Schiller M.W., Lopes P., Nogueira R.N., Pinto J.L., Claramunt R. & Simões J.A. (2007) Plated and Intact Femur Strains in Fracture Fixation Using Fiber Bragg Gratings and Strain Gages, *Exp Mech*, vol.47: 355-363
- Tjin S. C., Tan Y. K., Yow M., Lam Y. Z. & Hao J. (2001) Recording compliance of dental splint use in obstructive sleep apnoea patients by force and temperature modeling, *Med Biol Eng Comput*, vol.39:182-184

- Tiwari U., Mishra V., Poddar G.C., Kesavan K., Jain S.C., Ravisankar K., Singh N. & Kapur P. (2009) Health Monitoring of Steel and Concrete Structures using Fiber Bragg Grating Sensors, *Current Science*, vol. 97(11) 1539-42.
- Tiwari U., Mishra V., Bhalla A., Singh N., Jain S.C., Garg H., Raviprakash S., Grewal N. & Kapur P. (2011) Fiber Bragg grating Sensor for Measurement of Impact Absorption Capability of Mouthguards, *Dental Traumatology*, vol.27: 263-268.
- Webb D.J., Hathaway M.W., Jackson D.A., Jones S., Zhang L., Bennion I. (2000) First in-vivo trials of a fiber Bragg grating based temperature profiling system, *J Biomed Opt*, vol.5: 45-50
- Wehrle G., Nohama P., Kalinowski H., Torres P.I. & Valente L.C.G. (2001) A fiber optic Bragg grating strain sensor for monitoring ventilatory movements, *Meas. Sci. Technol.* vol.12: 805-809
- Yang C., Zhao C., Wold L., Kaufman K.R. (2003) Biocompatibility of a physiological pressure sensor, *Biosensors and Bioelectronics* vol.19: 51-58



Biomedicine

Edited by Dr. Chao Lin

ISBN 978-953-51-0352-3

Hard cover, 200 pages

Publisher InTech

Published online 21, March, 2012

Published in print edition March, 2012

Comprehensive and systematic scientific researches in cell biology and molecular biology have promoted the evolution of traditional medicine. Scientists are now able to interpret a few perplexed medical difficulties with the emphasis on molecular levels. This book focuses on frontier progress in modern biomedical science dealing with regenerative medicine, gene medicine, nanobiomedicine, and medical devices. Each chapter is intently chosen and written by professional experts in the field of biomedical science. Biomedicine is a valuable guide for the readers to become aware of current advancement in rapidly moving field of biomedicine.

How to reference

In order to correctly reference this scholarly work, feel free to copy and paste the following:

Vandana Mishra and Nahar Singh (2012). Optical Fiber Gratings in Perspective of Their Applications in Biomedicine, Biomedicine, Dr. Chao Lin (Ed.), ISBN: 978-953-51-0352-3, InTech, Available from: <http://www.intechopen.com/books/biomedicine/optical-fiber-gratings-in-perspective-of-their-applications-in-biomedicine>

INTECH
open science | open minds

InTech Europe

University Campus STeP Ri
Slavka Krautzeka 83/A
51000 Rijeka, Croatia
Phone: +385 (51) 770 447
Fax: +385 (51) 686 166
www.intechopen.com

InTech China

Unit 405, Office Block, Hotel Equatorial Shanghai
No.65, Yan An Road (West), Shanghai, 200040, China
中国上海市延安西路65号上海国际贵都大饭店办公楼405单元
Phone: +86-21-62489820
Fax: +86-21-62489821

© 2012 The Author(s). Licensee IntechOpen. This is an open access article distributed under the terms of the [Creative Commons Attribution 3.0 License](#), which permits unrestricted use, distribution, and reproduction in any medium, provided the original work is properly cited.