

Miniaturized Mass Spectrometer in Analysis of Greenhouse Gases: The Performance and Possibilities

Shuichi Shimma and Michisato Toyoda
Osaka University
Japan

1. Introduction

It is no doubt that mass spectrometry (MS) is widely applied to several research fields. In recent years, design and development of novel miniaturized mass spectrometers have been at the forefront of research in MS. A lot of miniaturized mass spectrometers are reported and commercialized from a lot of institutes and industries. The instruments have widespread applications, for example, detection and identification of chemical and biological hazards for the homeland security (Contreras et al., 2008; Smith et al., 2011), the food safety (Garcia-Reyes et al., 2009) and so on. Because of their small size and lightweight, miniaturized mass spectrometers have a potential for field use. These features are absolutely suitable for on-site environmental analyses, especially in greenhouse gases analyses. However, there are few reports on application of miniaturized mass spectrometers in this research field. This chapter describes instrumentation and application feasibility of miniaturized mass spectrometers to the greenhouse gases analysis. This chapter is consists of following four sections.

1. New analytical concept of “On-site mass spectrometry” and field usable mass spectrometers,
2. Introduction of our technology: multi-turn time-of-flight (TOF) mass spectrometer (MULTUM),
3. Miniaturized ultra-high mass resolution multi-turn TOF mass spectrometer “MULTUM-S II”,
4. Application of greenhouse gases detection using MULTUM-S II.

2. “On-site mass spectrometry” using miniaturized mass spectrometers

In this section, a novel analytical concept “On-site mass spectrometry”, overview of several reported miniaturized mass spectrometers and issues for the field use are mentioned.

2.1 On-site mass spectrometry

The basis of science is to measure phenomena of nature in real-time and with strict accuracy. However, we know that it is the most difficult to perform such measurements using high

performance analyzers. We must often prepare a lot of appropriate instruments to detect each target. In this sense, the features of mass spectrometers, for example variations of detectable targets, sensitivity and throughput, have advantages over other analytical instruments. Based on this point, "On-site mass spectrometry" is to bring high specifications mass spectrometers into field sites and to provide high quality mass spectrometric data in real-time. This concept is challenging, but on-site mass spectrometry attracts rising attention.

Considering conventional analytical methodologies using mass spectrometers, samples are usually taken from field sites. Then, the samples are brought into laboratories and purified before introducing into high performance mass spectrometers. Here, high performance mass spectrometers equipped in the laboratory have generally large size. To bring mass spectrometers into the on-site is required in several research fields, however, can we bring such instruments into the on-site? The answer is probably impossible. It is essential to miniaturize mass spectrometers with keeping performances ideally. Furthermore, we have to require not only simple and high performance miniaturized mass spectrometers to measure poorly purified samples but also simple sampling methods/sample preparations.

2.2 Overview of miniaturized mass spectrometers

Methods to reduce weight and size were attempted by various research groups. According to the reported papers on miniaturized mass spectrometers, a wide variety of instruments type including ion traps, quadrupole mass filters (QMF) (Gear et al., 2005), magnetic sector mass spectrometers (Diaz et al., 2001a; Diaz et al., 2001b), and TOF mass spectrometers (Cornish&Cotter, 1997; Cotter et al., 1999; Berkout et al., 2001; Ecelberger et al., 2004) were described. The main specifications are summarized in Table 1. It is considered that ion traps or QMF are more favourable than other instruments for miniaturization. In fact, almost all commercialized miniature mass spectrometers, for example *Guardion-7* (Lammert et al., 2006) and *Griffin Analytical 600* in Table 1, have adopted ion traps and QMF. In addition, it can be noted that there is a large variety of ion traps: (1) three dimensional hyperbolic ion traps, (2) rectilinear ion traps (Liang et al., 2008; Fico et al., 2009; Li et al., 2009; Ouyang et al., 2009), (3) toroidal ion traps (Lammert et al., 2006), (4) planar electrode ion traps (Austin et al., 2007; Austin et al., 2008; Yang et al., 2008), and (5) cylindrical ion traps (Van Amerom et al., 2008; Wells et al., 2008; Chaudhary et al., 2009).

Why were a lot of miniaturized mass spectrometers developed using ion trap techniques? The main reasons for choosing ion traps for portable instruments are that ion traps provide a relaxed vacuum condition, simple structures for easily miniaturized geometry with weight saving. A portable ion trap mass spectrometer system "Mini 11" was reported in 2009 (Gao et al., 2009), whose total weight with batteries is 5.0 kg, power consumption is 35 W, and dimensions are 22 cm x 12 cm x 18 cm. In addition to the miniaturized characteristics, the instrument has been coupled with wide varieties of ambient ionization sources, for example desorption electrospray ionization, electrospray ionization and paper spray ionization (Li et al., 2011; Soparawalla et al., 2011).

Instrument	Weight (kg)	Power (W)	Size (H x L x W mm)	Analyzer type
Mini 11	4	30	180 x 220 x 120	Rectilinear ion trap
Guardion-7	14.5	120	380 x 390 x 230	Toroidal ion trap
HAPSITE system	19	30	180 x 460 x 430	QMF
Griffin 450 Suitcase	8.6	600	488 x 488 x 536	Cylindrical ion trap
TOF	-	-	-	TOF
IonCam	19	150	438 x 432 x 254	Mattauch-Herzog sector
MULTUM-S II	36	600	450 x 640 x 230	TOF

Instrument	Ionization method	Mass (m/z) range	Resolution	Vendor/institute
Mini 11	MIMS, direct leak, ESI, DESI	2000	100	Purdue University
Guardion-7	EI	40 - 500	540	Torion Technologies Inc.
HAPSITE system	EI	41 - 300	-	INFICON
Griffin 450	EI	40 - 425	400	FLIR
Suitcase TOF	MALDI	50 000	30	Johns Hopkins Univ.
IonCam	EI	7 - 250	250	O. I. Analytical
MULTUM-S II	EI	1 - 1000	30 000	Osaka University

Table 1. Specifications of miniaturized mass spectrometers. MIMS, membrane inlet MS; EI, electron ionization; DESI, desorption electrospray ionization; ESI, electro spray ionization; MALDI, matrix-assisted laser desorption ionization.

2.3 A few issues for miniaturized mass spectrometers

Miniaturized instruments, especially ion traps or QMF described above, appear to have usable performance in the field use. However, sensitivity and mass resolution in these physically smaller devices are lower compared to laboratory instruments. To overcome the loss of sensitivity due to lower transmission of ions into and out of the analyzer, ion traps using array geometry were proposed. On the other hand, high mass resolution cannot in principal be obtained in QMF or ion traps. The typical mass resolution in miniaturized mass spectrometers is less than a few hundreds as shown in Table 1.

We consider that miniaturized instruments would be more commonly utilized in the future. In particular, high mass resolution is important when it is difficult to perform sufficient sample preparations as described in section 1. In this case, high mass resolution is important to avoid false positive and false negative from contaminant peaks.

How can we realize miniaturized high mass resolution mass spectrometers? In general, mass spectrometers for high mass resolution mass spectrometry are magnetic sector mass analyzers, Fourier transform ion cyclotron resonance (FT-ICR) mass spectrometers (Marshall

et al., 1998; Hu et al., 2005), and TOF mass spectrometers. However, if high mass resolution is to be achieved in these instruments, the size of instruments will become large and heavy. Especially, magnetic sector mass analyzers and FT-ICR mass spectrometers are required large electrical magnets and superconductive magnets. Therefore, it is difficult for simply miniaturized these instruments to improve mass resolution. This point is supported by specifications of IonCam listed in Table 1 (Hadjar et al., 2011).

According to the structural simplicity and weight, TOF mass spectrometers are more favorable for reduction in size. Here, the mass resolution ($m/\Delta m$) of TOF can be written as

$$\frac{m}{\Delta m} = \frac{T}{2\Delta T} \quad (1)$$

T and ΔT are TOF and a peak width (FWHM: full-width at half maximum), respectively. We can easily find that mass resolution is directly proportional to TOF (i. e., the size of the instrument). Therefore, simply shortening of the flight length to miniaturize the instrumentation size decreases mass resolution.

To overcome this fundamental problem, the flight length is extended by various methods. The proposed systems are listed as follows:

1. Electrostatic multi-pass mirror systems (Wollnik&Przewloka, 1990; Casares et al., 2001; Wollnik&Casares, 2003).
2. Helical or jig-saw type systems (Matsuda, 2000; Satoh et al., 2005; Satoh et al., 2007; Yavor et al., 2008; Satoh et al., 2011).
3. Multi-turn ion optical geometries using electrostatic sectors (Poschenrieder, 1972).

In our laboratory, the multi-turn type TOF mass spectrometers, which have a figure of eight flight path, are mainly designed and constructed. The first multi-turn TOF mass spectrometer "MULTUM-Linear plus" was constructed. In the next section, we will introduce the overview and the developing history.

3. History of multi-turn time-of-flight (TOF) mass spectrometers in Osaka University

Detailed discussions about the ion optical conditions which need to be met for operation of the multi-turn TOF mass spectrometer have been given elsewhere (Ishihara et al., 2000). Here, we simply explain the overview of our developed system and features of the ion optical system of the multi-turn TOF mass spectrometer.

3.1 Development history of MULTUM at Osaka University

Figure 1 shows the development history of multi-turn TOF mass spectrometers at Osaka University. We designed and constructed the first multi-turn TOF mass spectrometer "MULTUM Linear plus" as a laboratory model for cometary exploration (Matsuo et al., 1999; Toyoda et al., 2000; Toyoda et al., 2003). The system consists of four discrete units, each comprised of an electrostatic quadrupole lens, a cylindrical electrostatic sector and an electrostatic quadrupole lens. The total path length of one cycle is 1.284 m. The entire system

was fixed on a base plate of 40 cm x 40 cm. Using the electron ionization (EI) for a gas analysis, a maximum mass resolution using this instrument of 350 000 (m/z 28 of N_2^+) was achieved after 500 cycles (approximately 645 m in flight length). This system was not simple for operation; 28 electrostatic quadrupole lenses were used. As a next generation multi-turn mass spectrometer, we studied more simplified optical geometries. As a result, a new geometry of "MULTUM II" was designed and constructed (Okumura et al., 2004a; Okumura et al., 2004b). In the MULTUM II geometry, no quadrupole lenses were used. MULTUM II consisted of only four toroidal electrostatic sectors. The components were dramatically reduced. The total path length of one cycle was 1.308 m.

Development History of MULTUM at Osaka University

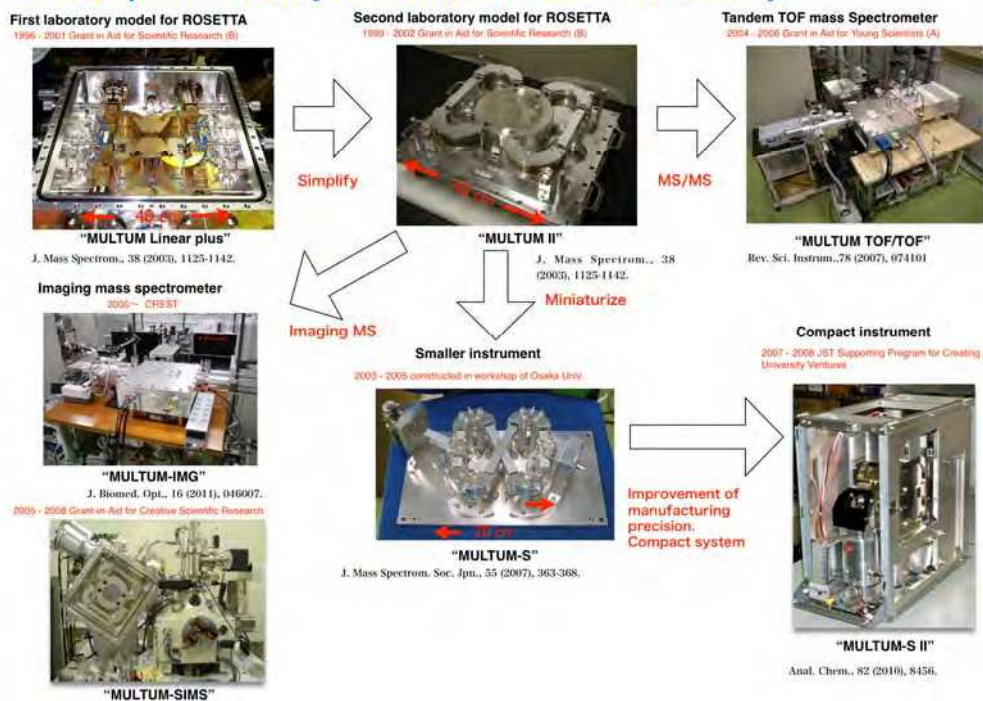

Fig. 1. Development history of MULTUM series.

The maximum mass resolution of 250 000 (m/z 28 of N_2^+) was achieved after 1200 cycles (approximately 1500 m in flight length). MULTUM II was equipped with not only the EI ion source but a matrix-assisted laser desorption/ionization (MALDI) ion source for biological applications. Using the MALDI ion source, a mass resolution of 61 000 was achieved for a deca peptide of angiotensin I.

Recently, we have been developing various types of mass spectrometers based on the MULTUM II technology. The first instrument was a tandem TOF mass spectrometer "MULTUM-TOF/TOF" for the structural analysis of biomolecules (Toyoda et al., 2007). The second instruments were used for imaging mass spectrometry. Here, imaging mass

spectrometry is a novel visualization method using mass spectrometry (Amstalden et al., 2010). The stigmatic imaging was performed with “MULTUM-IMG” (Hazama et al., 2008a; Hazama et al., 2008b). Another instrument was equipped with an ionization source for secondary ion mass spectrometry (SIMS), so that the instrument was used for high spatial resolution (approximately sub micrometer) imaging mass spectrometry. The third instruments were miniaturized multi-turn TOF mass spectrometers “MULTUM-S” and “MULTUM-S II” (Shimma et al., 2010). MULTUM-S was the first prototype. This instrument was manufactured using a wide-use lathe and milling machine, resulting in a lack of manufacturing precision and assembly accuracy. The “MULTUM-S II” was optimized the design of ion optics and manufacturing precision. The detailed descriptions of MULTUM-S II are found in section 4.

3.2 Ion optics of MULTUM

There are two conditions that are required for multi-turn systems. The first is the geometrical conditions, namely the necessity to close the ion optical orbit. Multi-turn TOF mass spectrometer geometries with such an orbit have previously been proposed (Poschenrieder, 1972; Sakurai et al., 1999). They did not, however, satisfy the second condition, namely the “perfect focusing” condition (Ishihara et al., 2000). Therefore, in these cases, it is expected that the ion beam will diverge in both time and space. Then, both the mass resolution and the ion transmission (sensitivity) are compromised as the number of cycles around the instrument increases. To avoid this problem, ions should return to the point of origin in the system. In other words, the absolute value of the position and angle at the final position (which is identical with the initial position) should be the same as at the initial position in both the horizontal and vertical directions. Such conditions can be expressed using the transfer matrix method in the first order approximation as

$$\begin{pmatrix} x_f \\ \alpha_f \\ y_f \\ \beta_f \\ \gamma \\ \delta \\ l_f \end{pmatrix} = \begin{pmatrix} \pm 1 & \underline{0} & 0 & 0 & 0 & \underline{0} & 0 \\ \underline{0} & \pm 1 & 0 & 0 & 0 & \underline{0} & 0 \\ 0 & 0 & \pm 1 & \underline{0} & 0 & 0 & 0 \\ 0 & 0 & \underline{0} & \pm 1 & 0 & 0 & 0 \\ 0 & 0 & 0 & 0 & 1 & 0 & 0 \\ 0 & 0 & 0 & 0 & 0 & 1 & 0 \\ \underline{0} & \underline{0} & 0 & 0 & R(l|\gamma) & \underline{0} & 1 \end{pmatrix} \times \begin{pmatrix} x_i \\ \alpha_i \\ y_i \\ \beta_i \\ \gamma \\ \delta \\ l_i \end{pmatrix} \quad (2)$$

Here, the ion optical position vectors $(x, \alpha, y, \beta, \gamma, \delta)$, where x, y and α, β denote the lateral and angular deviations of the ion under consideration from a reference ion at the object. The mass and energy deviations and pathlength deviation are described as γ, δ and λ . The subscripts i and f represent initial and final position, respectively. It should be noted that the character $\underline{0}$ (zero with underline) means the matrix element which should be forced to be zero. Accordingly, we require the “nine-fold focusing”, i.e. the nine $\underline{0}$ elements should be zero. By introducing symmetry in the arrangement of the ion optical components (i. e. the figure of eight geometry), multiple focusing conditions are easily achieved. We found ion optical systems (“MULTUM”, “MULTUM II”) for a multi-turn TOF mass spectrometer which satisfy perfect focusing.

4. Miniaturized multi-turn TOF mass spectrometer “MULTUM-S II”

In this section, we explain the system and novel characteristics of the recently developed miniaturized TOF mass spectrometer “MULTUM-S II”

4.1 Overview of MULTUM-S II

Photograph of the developed MULTUM-S II system are shown in Fig. 2. The size of the analyzer is less than 20 cm x 20 cm, which is the half size of MULTUM II (Fig. 2a). The photograph of the whole system is shown in Fig. 2b. The developed system consists of the following: the ion source, multi-turn mass analyzer, vacuum system, and high voltage circuit unit. The complete mass spectrometer weighs 35 kg. The total size of the instrument is 45 cm x 25 cm x 64 cm. The equipped ionization source is a two-stage acceleration ion source of EI type introduced by W. C. Wiley and I. H. McLaren (Wiley&McLaren, 1955). The accelerated ions are focused using the Einzel lens. After focusing, the ions are injected into the multi-turn TOF mass spectrometer.

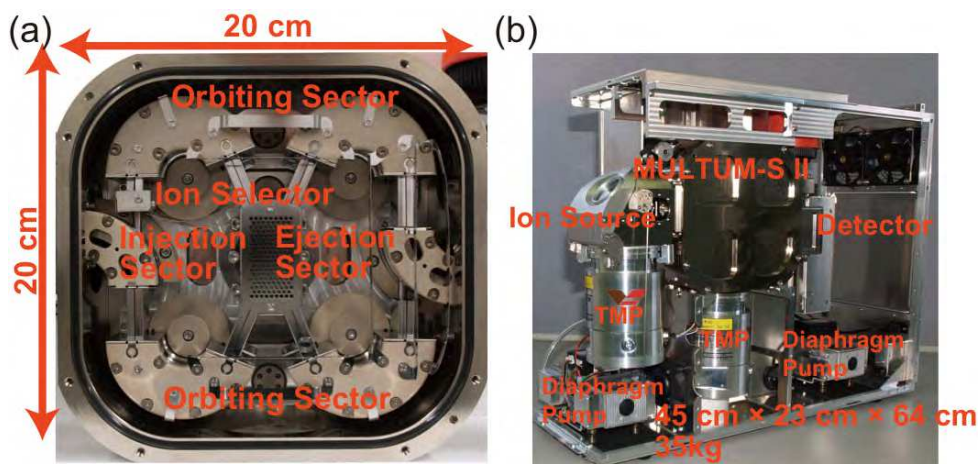

Fig. 2. Desktop high-mass resolution TOF mass spectrometer “MULTUM-S II”; (a) the inside of the analyzer, (b) the outside of the system.

The main geometry of the analyzer was the same as MULTUM II. In the miniaturized instruments, it is an important issue on how ions are introduced with high efficiency into the mass analyzer from the ion source. Additionally, introduced ions need to travel with stability in the closed orbit to obtain high mass resolution. In the previous MULTUM system described in section 3, the ion beam passed through small holes in the outer electrodes of two of the electric sectors. When ions were injected or ejected, the voltages applied to the sector electrodes were switched. To prevent the reduction of resolution due to instability of the power supply for switching, we offer higher stability (< 50 ppm) (Toyoda et al., 2007).

In order to overcome the problem of ion injection/ejection and stable traveling, MULTUM-S II has two additional sectors shown in Fig. 2a. Since these sectors specialized in ion injection/ejection, the static voltage is simply applied to the orbiting sectors. For this reason, the electrical circuits for MULTUM-S II could be simplified and miniaturized.

4.2 Data acquisition methods

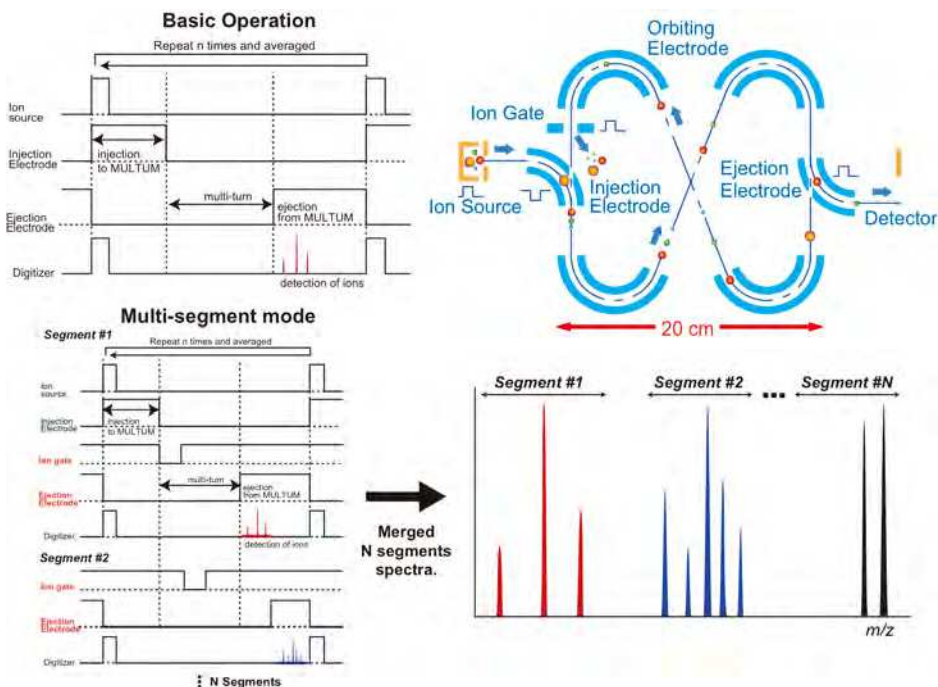

Fig. 3. Operation diagram of MULTUM-S II.

Block diagrams of the timing control are shown in Fig. 3. In the basic operation, the ions were extracted from the EI ion source by applying the pulsed voltage to the push electrode. The voltage applied to Injection Electrode was turned on when ions were injected into the analyzer part. After the ions had been injected into the analyzer, the voltage applied to Injection Electrode was turned off. On the other hand, the voltage applied to Ejection Electrode was initially switched off; thus, the ion packets flew into the closed orbit composed of Orbiting Electrodes. After a preset number of cycles, the voltage applied to Ejection Electrode was switched on, and the ion packets were ejected from the closed orbit. Then, the ions were detected. Therefore, the switching timing of Ejection Electrode controlled the number of cycles. Due to the performance of the digitizer equipped in our system, the repetition time of the cycle in Fig. 3 was 1 kHz. Therefore, acquisition time for one spectrum was 1 millisecond.

This feature becomes powerful tool for specific ion measurement, however “Overtaking problem” will appear in detection of ions over the wide mass range. During orbiting, lighter ions take over the heavier ions, because the ion speed depends on the mass of the ion. To avoid the over taking problem, the measuring mass range is divided into some segments. In this multi-segment mode, Ion Gate equipped in the orbiting trajectory controls the mass range. Therefore, the switching timing of Ion Gate and Ejection Electrode are individually configured as shown in Fig. 3. In this operation mode, our software automatically calculates

the timing of Ion Gate and Ejection Electrode. Users can only input the target mass value and the number of cycles. After spectra acquisition, obtained segment mass spectra are merged in one spectrum as shown in Fig. 3.

4.3 Obtained mass spectra of low mass ions using MULTUM-S II

In the specifications of mass spectrometer, the detectable mass range is important. The wide mass range is obviously preferred. The upper mass is restricted to the ionization methods, so that the upper mass value of MULTUM-S II is approximately m/z 1000. The lower limit is also important for the simultaneous gas analysis. However, high resolution MS in the low mass region, which is less than m/z 50, is generally difficult due to the electric noise from the instruments. As shown in Table 1, the lower mass limits of almost all instruments are m/z 40. In our instrument, the electric circuits are very simple. This feature becomes a strong advantage in detection of low mass molecules. Figure 4 is detection of hydrogen. In this experiment, standard gas of hydrogen was directly introduced into the ionization chamber via a needle valve. The peak at m/z 2 derived from hydrogen molecules were clearly detected. The detected peaks around m/z 15 were derived from residual gases. This result demonstrated that the detectable mass range in MULTUM-S II was very wide.

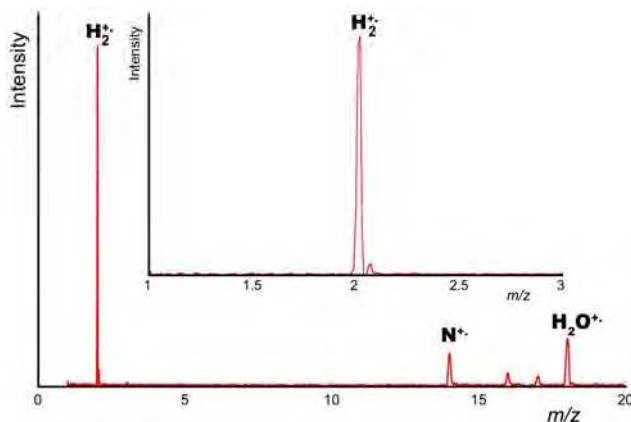

Fig. 4. Detection of molecules in the low mass region. Hydrogen molecule was detected with low electrical noise.

The next result is a separation of helium atom (He) and deuterium molecules (D_2). Since both He and D_2 had the nominal mass of m/z 4, He and D_2 were detected as one peak in the low mass resolution mass spectrum (Fig. 5a). To obtain this spectrum, the standard gases of He and D_2 were directly introduced into the ionization chamber via the needle valve. Before the introduction, these two gases were mixed in the gas-sampling bag. Figure 5b is the high mass resolution mass spectrum at 10 cycles. The values of the accurate mass were 4.0026 in He and 4.0282 in D_2 . Although the mass difference between He and D_2 was 0.025 u, MULTUM-S II was able to easily separate He and D_2 even in the miniaturized instrument.

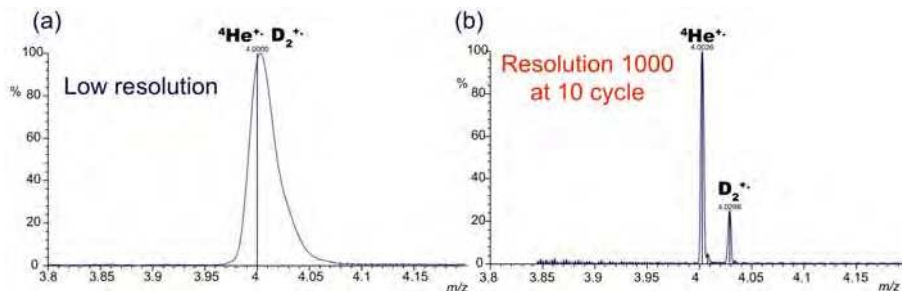

Fig. 5. Separation of ^4He and D_2 doublet; (a) the low mass resolution mass spectrum and (b) high mass resolution mass spectrum. The number of cycles was 10 cycles.

5. Applications for greenhouse gases detection using “MULTUM-S II”

As shown in section 4, MULTUM-S II have a powerful potential especially for the gas detection. The final section describes application of MULTUM-S II for high resolution and simultaneous greenhouse gases detection, especially carbon dioxide (CO_2), nitrous oxide (N_2O) and methane (CH_4). In the conventional methodology in the field study, researchers collect samples in the field, bring them into laboratory, and then analyze using laboratory equipped instruments. As another procedure, researchers prepare and place several detectors to detect each species directly in the field. However, a great variety of detectable species and portability in MULTUM-S II will be the powerful merits for the field study in the future. This high quality gas analyzer will also help the reduction of systematic error attributed to different detectors and measurement conditions.

5.1 High mass resolution mass spectra of greenhouse gases

Figure 6 is a high-mass resolution mass spectrum of CH_4 at 10 cycles. In this spectrum, the peak of CH_4 is separated from the oxygen peak (both nominal mass is m/z 16) derived from the fragment ion of the oxygen molecule or di-charged ion of oxygen molecule. The obtained mass resolution was 3200. We consider that this feature is merit for monitoring of CH_4 without oxygen contamination.

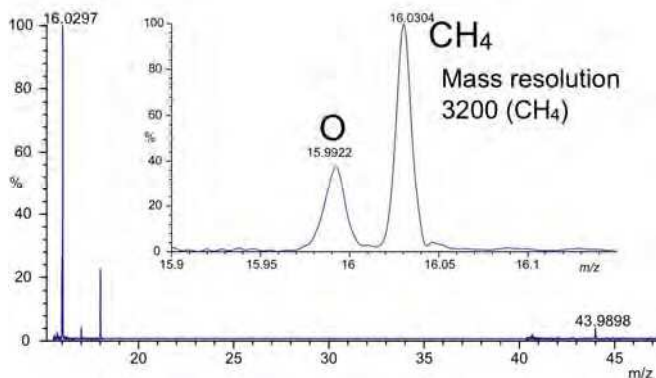

Fig. 6. High-resolution mass spectrum of oxygen and methane.

Real-time monitoring of N_2O is required to elucidate the generating mechanism and investigate its trend of spread. N_2O is known as the greenhouse gas, and the warming effect is about 310 times larger than CO_2 . Furthermore, N_2O is one of the ozone-depleting substances (Ravishankara et al., 2009). If we try to carry out real-time monitoring of N_2O and CO_2 simultaneously using mass spectrometry, a mass spectrometer with high mass resolution is required, because the nominal mass of N_2O is the same as that of CO_2 . However, the difference of accurate mass between CO_2 and N_2O is 0.0113 u, therefore these two peaks were expected to be separated in MULTUM-S II as shown in Fig. 5 (b) and Fig. 6. In this experiment, the mixture of ultrapure CO_2 and N_2O (49.4%:50.6%) was purchased from DAIHO SANGYO Inc. (Minato-ku, Tokyo, Japan). This standard gas was introduced into the EI ion source via the needle valve. Figure 7 shows the obtained mass spectra by changing the number of cycles. Figure 7a shows the mass spectrum of the CO_2 and N_2O doublet peak after 10 cycles. In this cycle, the doublet peak did not still separate due to the lack of mass resolution. After 20 cycles (Fig. 7b), the top of the peak began to separate. After 50 cycles (Fig. 7c), these two peaks were

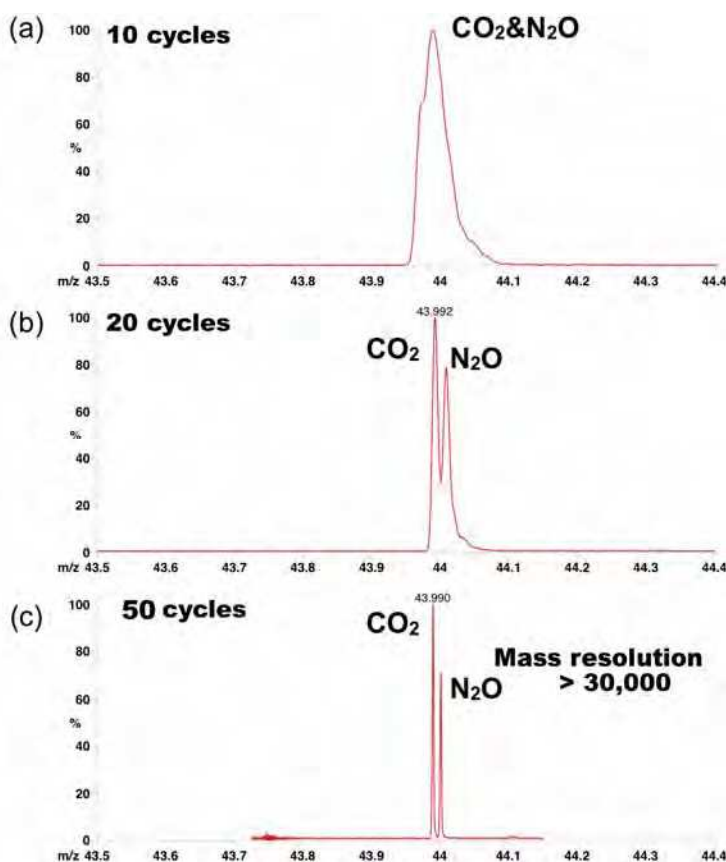

Fig. 7. Separation of CO_2 and N_2O doublet; the spectrum at (a) 10 cycles, (b) 20 cycles and (c) 50 cycles.

completely separated, and consequently, the obtained mass resolution was 30 000. This ultra high mass resolution was firstly achieved in the miniaturized mass spectrometers. This mass resolution was comparable to those of laboratory-equipped instruments. We would like to note that the maximal time to acquire one spectrum was 1 millisecond as described in section 4.2. Therefore, high mass resolution accompanying the fast data acquisition will be helpful for the on-site real-time monitoring.

Achieving high mass resolution is advantageous when trying to determine accurate masses. In the previous study, the mass accuracy of 2.3 ppm was achieved (Shimma et al., 2010). Availability of accurate mass measurement in the miniaturized mass spectrometer is another advantage to MULTUM-S II.

5.2 Direct sample injection method

We could confirm the separation of CO₂ and N₂O doublet using MULTUM-S II. The next experiment was to perform the simultaneous gas detection. In the simultaneous gas detection, there was concern about a dynamic range. To confirm the capability of detection in both low and high concentration species, detection of 30 ppm N₂O in the air was performed. The standard gas of 30 ppm N₂O (N₂ balanced) was purchased from DAIHO SANGYO Inc. In this experiment, the operation mode of multi-segment mode was used. Three segments were configured to detect N₂, O₂, CO₂ and N₂O. The obtained mass spectrum at 50 cycles is shown in Fig. 8.

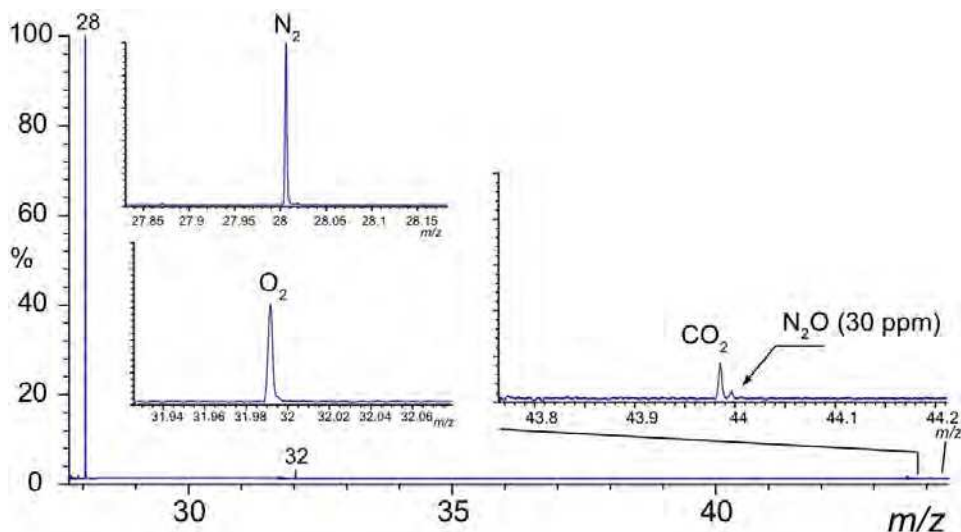

Fig. 8. Simultaneous gas detection of N₂, O₂, CO₂ and N₂O in 50 cycles.

As shown in Fig. 8, the balanced N₂ peak was predominantly detected. The 30 ppm N₂O was detected with complete separation of CO₂, however, the peak intensities of other species were extremely low. Considering the concentration of N₂O in the nature, the concentration is much lower than 30 ppm. Therefore, the dominant species of N₂ and O₂ in the air should be removed to realize the higher sensitive N₂O detection.

5.3 Combination of rough separation and high resolution MS for real-time monitoring

In the conventional gas chromatographic technique, the main contents of air (N_2 , O_2 , Ar) and (CO_2 , N_2O) can be separated using Carbon PLOT column. We firstly performed the gas chromatography of their content using a gas chromatography coupled with MULTUM-S II (Fig. 9a). In this experiment, the GS-CarbonPLOT column (30 m x 0.32 mm i.d.; 3 μ m film thickness) was purchased from Agilent Technologies (Santa Clara, CA, USA). The column temperature was kept an isothermal condition of 40°C. The obtained the total ion chromatogram and mass chromatogram of m/z 44 are shown in Fig. 9b. In these chromatograms, the non-polar contents of N_2 , O_2 and Ar were clearly separated from CO_2 and N_2O . Furthermore, due to the different polarity of CO_2 and N_2O , the enough separation of these peaks was also achieved. However, the duration of analysis was three minutes.

The generation of N_2O via activities of microorganisms is known as a fast process (HAYATSU et al., 2008; Kool et al., 2010). Therefore, higher sampling rate is likely to be required. According to the GC techniques, one of the methodologies to shorten analysis time is truncation of the capillary column. Understandably, the separation capability of the capillary column is reduced.

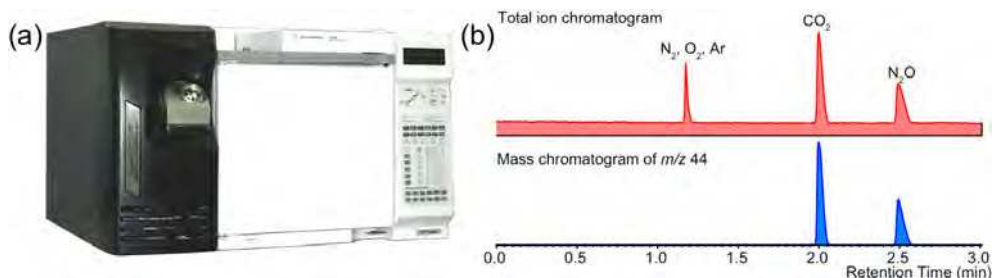

Fig. 9. (a) GC-MULTUM system; (b) the conventional chromatographic separation of (N_2 , O_2 , Ar) and (CO_2 , N_2O)

Here, we consider that higher separation capability for the GC system is unnecessary in this case. As shown in Fig. 7, the complete separation of CO_2 and N_2O can be available in our system. Therefore, we have only to perform the rough GC separation of (N_2 , O_2 , Ar) and (CO_2 , N_2O). To demonstrate this idea, we performed gas chromatography with a 10 m PLOT column.

The obtained chromatograms are shown in Fig. 10. We found that the separation was completed within one minute. In this experiment, the ions of N_2 and O_2 were not detected, because their retention time was too fast. According to the value of the vacuum gauge just after sample injection, the large amount of gases seemed to be injected into the ionization source at a time. Under this condition, electrical discharge could occur. Therefore, we applied the high voltage to the ionization source after five seconds of sample injection.

Due to the short capillary column, the peaks derived from CO_2 and N_2O were not separated in the total ion chromatogram shown in Fig. 10. However, the averaged mass spectra from the retention time 0.3 min to 0.35 min, the high-mass resolution mass

spectrometry was performed (inset of Fig. 10a). The obtained mass chromatograms are also shown in Fig. 10b and Fig. 10c. These results indicate that our idea worked correctly. We could establish the combination of rough gas chromatograph and high mass resolution mass spectrometry.

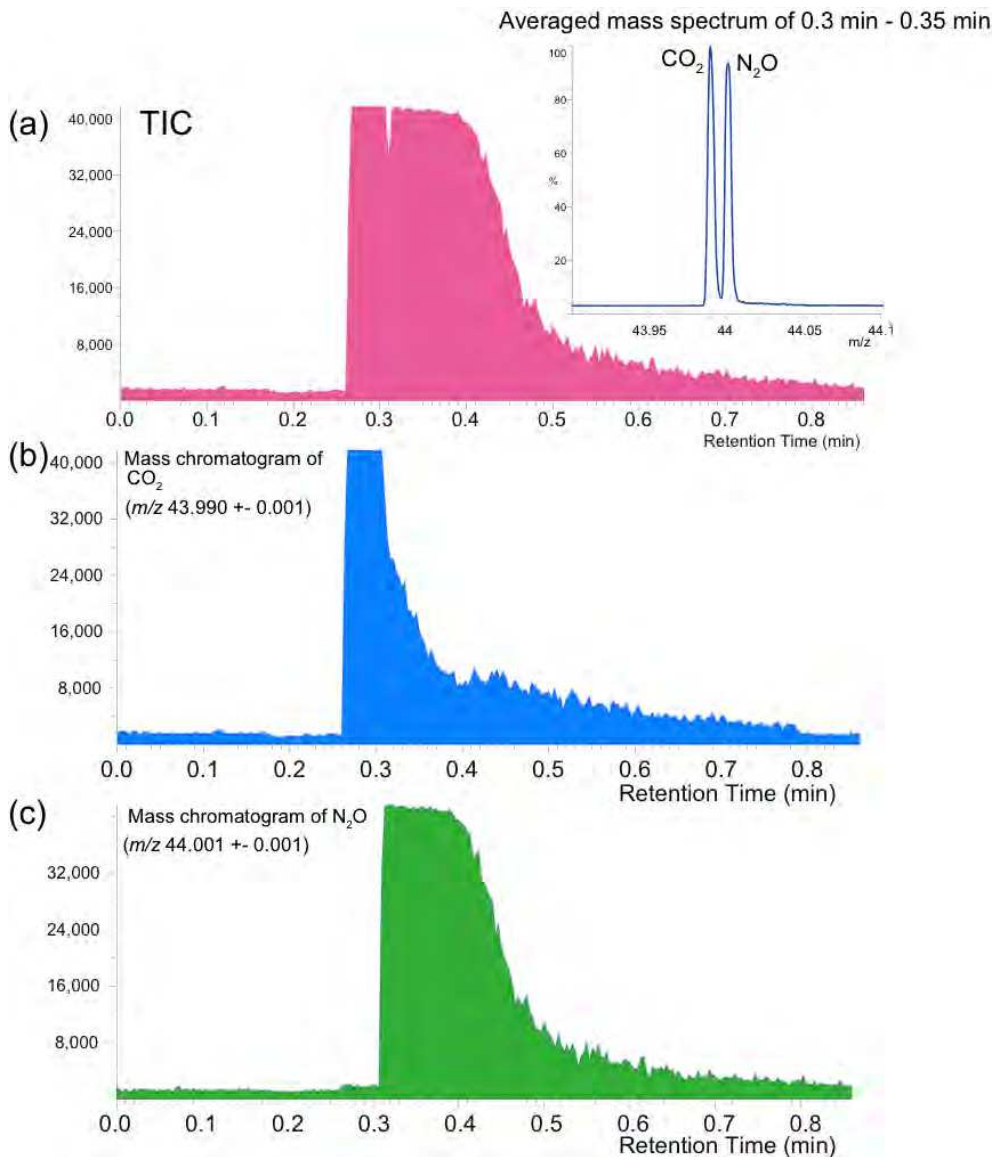

Fig. 10. The rough chromatographic separation of CO₂ and N₂O; (a) total ion chromatogram, (b) the mass chromatogram of CO₂, and (c) the mass chromatogram of N₂O.

5.4 Future tasks for on-site simultaneous greenhouse gas detection

We successfully confirmed the methodology to inject the main components of air and greenhouse gases separately into the ionization source. Considering the field use, to bring GC system to the field is unrealistic for the real-time monitoring. To overcome this problem, we designed and developed a simple automatic gas sampler (Fig. 11). This sampling system consists of a six port valve, two solenoid valves, a mass flow controller, a sampling loop, a diaphragm pump for the gas sampling, and the short PLOT column. The operation of valves is controlled using a lab-built LabVIEW base software. In our laboratory, the performance evaluation of this sampling system including the optimization of sampling condition is ongoing.

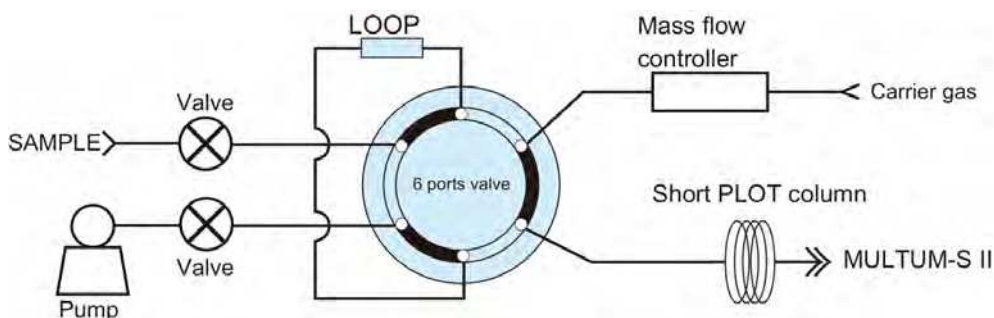

Fig. 11. Proposed automatic gas sampler.

Another task to realize the high sensitive on-site greenhouse gas monitor is reduction of background pressure in the analyzer. The typical pressure value during measurement was between 8×10^{-5} Pa and 1×10^{-4} Pa. This pressure was insufficient for the sub ppm level N_2O detection. Due to higher background pressure, contamination peaks derived from residual gases in analyzer were detected. Ionization space in the EI source is understandably finite, therefore the total number of ions stored in the ionization source is also finite. This is known as the space charge effect. If the contaminant ions are reduced, the number of ions of interest will be relatively increased. To realize the pressure below 10^{-5} Pa level, we designed a highly sealed ionization chamber specialized for the gas monitoring. The material of the chamber was titanium to reduce outgassing from the inner chamber wall. This chamber will be manufactured in the near future.

6. Conclusion

In this chapter, we described the overview of novel miniaturized mass spectrometers and their applications. Our developed the unique miniaturized TOF mass spectrometer "MULTUM-S II" has comparable mass resolution to lab-equipped mass spectrometers ($m/\Delta m > 30\ 000$). At present, we performed proof-of-concept studies for real-time

greenhouse gas monitoring system using MULTUM-S II. Based on issues from this study, MULTUM-S II is under improvement for the high sensitive gas detection.

7. Acknowledgement

The authors thank Prof. Ryusuke Hatano of Hokkaido University for his fruitful discussion. This work was supported by a Supporting Program for Creating University Ventures, from the Japan Science and Technology Agency (JST). One of the authors (M. T.) was supported by Grant in Aid for Young Scientists (A) (21685010) from the Ministry of Education, Culture, Sports, Science and Technology, Japan.

8. References

- Amstalden v.H., Smith D.F. & Heeren R.M.A. (2010). A concise review of mass spectrometry imaging. *Journal of Chromatography A*, Vol. 1217, No. 25, pp. 3946-3954, ISSN 0021-9673.
- Austin D.E., Peng Y., Hansen B.J., Miller I.W., Rockwood A.L., Hawkins A.R. & Tolley S.E. (2008). Novel ion traps using planar resistive electrodes: Implications for miniaturized mass analyzers. *J. Am. Soc. Mass Spectrom.*, Vol. 19, No. 10, pp. 1435-1441, ISSN 1044-0305.
- Austin D.E., Wang M., Tolley S.E., Maas J.D., Hawkins A.R., Rockwood A.L., Tolley H.D., Lee E.D. & Lee M.L. (2007). Halo ion trap mass spectrometer. *Anal. Chem.*, Vol. 79, No. 7, pp. 2927-2932, ISSN 0003-2700.
- Berkout V.D., Cotter R.J. & Segers D.P. (2001). Miniaturized EI/Q/oa TOF mass spectrometer. *J. Am. Soc. Mass Spectrom.*, Vol. 12, No. 6, pp. 641-647, ISSN 1044-0305.
- Casares A., Kholomeev A. & Wollnik H. (2001). Multipass time-of-flight mass spectrometers with high resolving powers. *Int. J. Mass Spectrom.*, Vol. 206, No. 3, pp. 267-273, ISSN 1387-3806.
- Chaudhary A., van Amerom F.H.W. & Short R.T. (2009). Development of microfabricated cylindrical ion trap mass spectrometer arrays. *J. Microelectromech. S.*, Vol. 18, No. 2, pp. 442-448, ISSN 1057-7157.
- Contreras J.A., Murray J.A., Tolley S.E., Oliphant J.L., Tolley H.D., Lammert S.A., Lee E.D., Later D.W. & Lee M.L. (2008). Hand-portable gas chromatograph-toroidal ion trap mass spectrometer (GC-TMS) for detection of hazardous compounds. *J. Am. Soc. Mass Spectrom.*, Vol. 19, No. 10, pp. 1425-1434, ISSN 1044-0305.
- Cornish T.J. & Cotter R.J. (1997). High-order kinetic energy focusing in an end cap reflectron time-of-flight mass spectrometer. *Anal. Chem.*, Vol. 69, No. 22, pp. 4615-4618, ISSN 0003-2700.
- Cotter R.J., Fancher C. & Cornish T.J. (1999). Miniaturized time-of-flight mass spectrometer for peptide and oligonucleotide analysis. *J. Mass Spectrom.*, Vol. 34, No. 12, pp. 1368-1372, ISSN 1076-5174.
- Diaz J.A., Giese C.F. & Gentry W.R. (2001a). Portable double-focusing mass-spectrometer system for field gas monitoring. *Field Anal. Chem. Technol.*, Vol. 5, No. 3, pp. 156-167, ISSN 1086-900X.

- Diaz J.A., Giese C.F. & Gentry W.R. (2001b). Sub-miniature ExB sector-field mass spectrometer. *J. Am. Soc. Mass Spectrom.*, Vol. 12, No. 6, pp. 619-632, ISSN 1044-0305.
- Ecelberger S.A., Cornish T.J., Collins B.F., Lewis D.L. & Bryden W.A. (2004). Suitcase TOF: A man-portable time-of-flight mass spectrometer. *Johns Hopkins APL Tech. Dig.*, Vol. 25, No. 1, pp. 14-19, ISSN 0270-5214.
- Fico M., Maas J.D., Smith S.A., Costa A.B., Ouyang Z., Chappell W.J. & Cooks R.G. (2009). Circular arrays of polymer-based miniature rectilinear ion traps. *Analyt.*, Vol. 134, No. 7, pp. 1338-1347, ISSN 0003-2654.
- Gao L., Li G.T., Nie Z.X., Duncan J., Ouyang Z. & Cooks R.G. (2009). Characterization of a discontinuous atmospheric pressure interface. multiple ion introduction pulses for improved performance. *Int. J. Mass Spectrom.*, Vol. 283, No. 1-3, pp. 30-34, ISSN 1387-3806.
- Garcia-Reyes J.F., Jackson A.U., Molina-Diaz A. & Cooks R.G. (2009). Desorption electrospray ionization mass spectrometry for trace analysis of agrochemicals in food. *Anal. Chem.*, Vol. 81, No. 2, pp. 820-829, ISSN 0003-2700.
- Gear M., Syms R.R.A., Wright S. & Holmes A.S. (2005). Monolithic MEMS quadrupole mass spectrometers by deep silicon etching. *J. Microelectromech. S.*, Vol. 14, No. 5, pp. 1156-1166, ISSN 1057-7157.
- Hadjar O., Johnson G., Laskin J., Kibelka G., Shill S., Kuhn K., Cameron C. & Kassin S. (2011). IonCCD for direct position-sensitive charged-particle detection: From electrons and keV ions to hyperthermal biomolecular ions. *J. Am. Soc. Mass Spectrom.*, Vol. 22, No. 4, pp. 612-623, ISSN 1044-0305.
- Hayatsu M., Tago K. & Saito M. (2008). Various players in the nitrogen cycle: Diversity and functions of the microorganisms involved in nitrification and denitrification. *Soil Science & Plant Nutrition*, Vol. 54, No. 1, pp. 33-45, ISSN 1747-0765.
- Hazama H., Aoki J., Nagao H., Suzuki R., Tashima T., Fujii K., Masuda K., Awazu K., Toyoda M. & Naito Y. (2008a). Construction of a novel stigmatic MALDI imaging mass spectrometer. *Appl. Surf. Sci.*, Vol. 255, No. 4, pp. 1257-1263, ISSN 0169-4332.
- Hazama H., Nagao H., Suzuki R., Toyoda M., Masuda K., Naito Y. & Awazu K. (2008b). Comparison of mass spectra of peptides in different matrices using matrix-assisted laser desorption/ionization and a multi-turn time-of-flight mass spectrometer, MULTUM-IMG. *Rapid Commun. Mass Spectrom.*, Vol. 22, No. 10, pp. 1461-1466, ISSN 0951-4198.
- Hu Q.Z., Noll R.J., Li H.Y., Makarov A., Hardman M. & Cooks R.G. (2005). The orbitrap: A new mass spectrometer. *J. Mass Spectrom.*, Vol. 40, No. 4, pp. 430-443, ISSN 1076-5174.
- Ishihara M., Toyoda M. & Matsuo T. (2000). Perfect space and time focusing ion optics for multiturn time of flight mass spectrometers. *Int. J. Mass Spectrom.*, Vol. 197, No. 1-3, pp. 179-189, ISSN 1387-3806.
- Kool D.M., Wrage N., Zechmeister-Boltenstern S., Pfeffer M., Brus D., Oenema O. & Van Groenigen J.-. (2010). Nitrifier denitrification can be a source of N₂O from soil: A revised approach to the dual-isotope labelling method. *Eur. J. Soil Sci.*, Vol. 61, No. 5, pp. 759-772, ISSN 1365-2389.

- Lammert S., Rockwood A., Wang M., Lee M., Lee E., Tolley S., Oliphant J., Jones J. & Waite R. (2006). Miniature toroidal radio frequency ion trap mass analyzer. *J. Am. Soc. Mass Spectrom.*, Vol. 17, No. 7, pp. 916-922, ISSN 1044-0305.
- Li A., Wang H., Ouyang Z. & Cooks R.G. (2011). Paper spray ionization of polar analytes using non-polar solvents. *Chem. Commun.*, Vol. 47, No. 10, pp. 2811-2813, ISSN 1359-7345.
- Li X.X., Jiang G.Y., Luo C., Xu F.X., Wang Y.Y., Ding L. & Ding C.F. (2009). Ion trap array mass analyzer: Structure and performance. *Anal. Chem.*, Vol. 81, No. 12, pp. 4840-4846, ISSN 0003-2700.
- Liang G., Sugiarto A., Harper J.D., Cooks R.G. & Zheng O.Y. (2008). Design and characterization of a multisource hand-held tandem mass spectrometer. *Anal. Chem.*, Vol. 80, No. 19, pp. 7198-7205, ISSN 0003-2700.
- Marshall A.G., Hendrickson C.L. & Jackson G.S. (1998). Fourier transform ion cyclotron resonance mass spectrometry: A primer. *Mass Spectrom.Rev.*, Vol. 17, No. 1, pp. 1-35, ISSN 0277-7037.
- Matsuda H. (2000). Spiral orbit time of flight mass spectrometer. *J. Mass Spectrom. Soc. Jpn*, Vol. 48, No. 5, pp. 303-305, ISSN 1340-8097.
- Matsuo T., Ishihara M., Toyoda M., Ito H., Yamaguchi S., Roll R. & Rosenbauer H. (1999). A space time-of-flight mass spectrometer for exobiologically-oriented applications. *Adv. Space Res.*, Vol. 23, No. 2, pp. 341-348, ISSN 0273-1177.
- Okumura D., Toyoda M., Ishihara M. & Katakuse I. (2004a). Application of a multi-turn time-of-flight mass spectrometer, MULTUM II, to organic compounds ionized by matrix-assisted laser desorption/ionization. *J. Mass Spectrom.*, Vol. 39, No. 1, pp. 86-90, ISSN 1076-5174.
- Okumura D., Toyoda M., Ishihara M. & Katakuse I. (2004b). A compact sector-type multi-turn time-of-flight mass spectrometer 'MULTUM II'. *Nucl. Instr. Meth. A*, Vol. 519, No. 1-2, pp. 331-337, ISSN 0168-9002.
- Ouyang Z., Noll R.J. & Cooks R.G. (2009). Handheld miniature ion trap mass spectrometers. *Anal. Chem.*, Vol. 81, No. 7, pp. 2421-2425, ISSN 0003-2700.
- Poschenrieder W.P. (1972). Multiple-focusing time-of-flight mass spectrometers part II. TOFMS with equal energy acceleration. *Int. J. Mass Spectrom. Ion Phys.*, Vol. 9, No. 4, pp. 357-373, ISSN 0020-7381.
- Ravishankara A.R., Daniel J.S. & Portmann R.W. (2009). Nitrous oxide (N₂O): The dominant ozone-depleting substance emitted in the 21st century. *Science*, Vol. 326, No. 5949, pp. 123-125, ISSN 0036-8075.
- Sakurai T., Nakabushi H., Hiasa T. & Okanishi K. (1999). A new multi-passage time-of-flight mass spectrometer at JAIST. *Nucl. Instr. Meth. A*, Vol. 427, No. 1,2, pp. 182-186, ISSN 0168-9002.
- Satoh T., Sato T. & Tamura J. (2007). Development of a high-performance MALDI-TOF mass spectrometer utilizing a spiral ion trajectory. *J. Am. Soc. Mass Spectrom.*, Vol. 18, No. 7, pp. 1318-1323, ISSN 1044-0305.
- Satoh T., Tsuno H., Iwanaga M. & Kammei Y. (2005). The design and characteristic features of a new time-of-flight mass spectrometer with a spiral ion trajectory. *J. Am. Soc. Mass Spectrom.*, Vol. 16, No. 12, pp. 1969-1975, ISSN 1044-0305.

- Satoh T., Sato T., Kubo A. & Tamura J. (2011). Tandem time-of-flight mass spectrometer with high precursor ion selectivity employing spiral ion trajectory and improved offset parabolic reflectron. *J. Am. Soc. Mass Spectrom.*, Vol. 22, No. 5, pp. 797-803, ISSN 1044-0305.
- Shimma S., Nagao H., Aoki J., Takahashi K., Miki S. & Toyoda M. (2010). Miniaturized high-resolution time-of-flight mass spectrometer MULTUM-S II with an infinite flight path. *Anal. Chem.*, Vol. 82, No. 20, pp. 8456-8463, ISSN 0003-2700.
- Smith J.N., Noll R.J. & Cooks R.G. (2011). Facility monitoring of chemical warfare agent simulants in air using an automated, field-deployable, miniature mass spectrometer. *Rapid Commun. Mass Spectrom.*, Vol. 25, No. 10, pp. 1437-1444, ISSN 1097-0231.
- Soparawalla S., Tadjimukhamedov F.K., Wiley J.S., Ouyang Z. & Cooks R.G. (2011). In situ analysis of agrochemical residues on fruit using ambient ionization on a handheld mass spectrometer. *Analyst*, ISSN 0003-2654.
- Toyoda M., Giannakopoulos A.E., Colburn A.W. & Derrick P.J. (2007). High-energy collision induced dissociation fragmentation pathways of peptides, probed using a multiturn tandem time-of-flight mass spectrometer "MULUM-TOF/FOF". *Rev. Sci. Instrum.*, Vol. 78, pp. 074101.
- Toyoda M., Ishihara M., Yamaguchi S., Ito H., Matsuo T., Roll R. & Rosenbauer H. (2000). Construction of a new multi-turn time-of-flight mass spectrometer. *J. Mass Spectrom.*, Vol. 35, No. 2, pp. 163-167, ISSN 1076-5174.
- Toyoda M., Okumura D., Ishihara M. & Katakuse I. (2003). Multi-turn time-of-flight mass spectrometers with electrostatic sectors. *J. Mass Spectrom.*, Vol. 38, No. 11, pp. 1125-1142, ISSN 1076-5174.
- Van Amerom F.H.W., Chaudhary A., Cardenas M., Bumgarner J. & Short R.T. (2008). Microfabrication of cylindrical ion trap mass spectrometer arrays for handheld chemical analyzers. *Chem. Eng. Commun.*, Vol. 195, No. 2, pp. 98-114, ISSN 0098-6445.
- Wells J.M., Roth M.J., Keil A.D., Grossenbacher J.W., Justes D.R., Patterson G.E. & Barket D.J. (2008). Implementation of DART and DESI ionization on a fieldable mass spectrometer. *J. Am. Soc. Mass Spectrom.*, Vol. 19, No. 10, pp. 1419-1424, ISSN 1044-0305.
- Wiley W.C. & McLaren I.H. (1955). Time-of-flight mass spectrometer with improved resolution. *Rev. Sci. Instrum.*, Vol. 26, No. 12, pp. 1150-1157.
- Wollnik H. & Casares A. (2003). An energy-isochronous multi-pass time-of-flight mass spectrometer consisting of two coaxial electrostatic mirrors. *Int. J. Mass Spectrom.*, Vol. 227, No. 2, pp. 217-222, ISSN 1387-3806.
- Wollnik H. & Przewloka M. (1990). Time-of-flight mass spectrometers with multiply reflected ion trajectories. *Int. J. Mass Spectrom. Ion Proc.*, Vol. 96, No. 3, pp. 267-274, ISSN 0168-1176.
- Yang M., Kim T.Y., Hwang H.C., Yi S.K. & Kim D.H. (2008). Development of a palm portable mass spectrometer. *J. Am. Soc. Mass Spectrom.*, Vol. 19, No. 10, pp. 1442-1448, ISSN 1044-0305.

Yavor M.I., Verentchikov A.N., Hasin J., Kozlov B., Gavrik M. & Trufanov A. (2008). Planar multi-reflecting time-of-flight mass analyzer with a jig-saw ion path. *Physics Procedia*, Vol. 1, No. 1, pp. 391-400, ISSN 1875-3892.

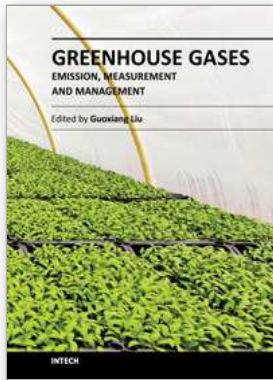

Greenhouse Gases - Emission, Measurement and Management

Edited by Dr Guoxiang Liu

ISBN 978-953-51-0323-3

Hard cover, 504 pages

Publisher InTech

Published online 14, March, 2012

Published in print edition March, 2012

Understanding greenhouse gas sources, emissions, measurements, and management is essential for capture, utilization, reduction, and storage of greenhouse gas, which plays a crucial role in issues such as global warming and climate change. Taking advantage of the authors' experience in greenhouse gases, this book discusses an overview of recently developed techniques, methods, and strategies: - A comprehensive source investigation of greenhouse gases that are emitted from hydrocarbon reservoirs, vehicle transportation, agricultural landscapes, farms, non-cattle confined buildings, and so on. - Recently developed detection and measurement techniques and methods such as photoacoustic spectroscopy, landfill-based carbon dioxide and methane measurement, and miniaturized mass spectrometer.

How to reference

In order to correctly reference this scholarly work, feel free to copy and paste the following:

Shuichi Shimma and Michisato Toyoda (2012). Miniaturized Mass Spectrometer in Analysis of Greenhouse Gases: The Performance and Possibilities, Greenhouse Gases - Emission, Measurement and Management, Dr Guoxiang Liu (Ed.), ISBN: 978-953-51-0323-3, InTech, Available from:

<http://www.intechopen.com/books/greenhouse-gases-emission-measurement-and-management/miniaturized-mass-spectrometer-in-analysis-of-greenhouse-gases-the-performance-and-possibilities->

INTECH

open science | open minds

InTech Europe

University Campus STeP Ri
Slavka Krautzeka 83/A
51000 Rijeka, Croatia
Phone: +385 (51) 770 447
Fax: +385 (51) 686 166
www.intechopen.com

InTech China

Unit 405, Office Block, Hotel Equatorial Shanghai
No.65, Yan An Road (West), Shanghai, 200040, China
中国上海市延安西路65号上海国际贵都大饭店办公楼405单元
Phone: +86-21-62489820
Fax: +86-21-62489821

© 2012 The Author(s). Licensee IntechOpen. This is an open access article distributed under the terms of the [Creative Commons Attribution 3.0 License](#), which permits unrestricted use, distribution, and reproduction in any medium, provided the original work is properly cited.