

# Effect of an Electric Motor on the Energy Efficiency of an Electro-Hydraulic Forklift

Tatiana Minav, Lasse Laurila and Juha Pyrhönen  
*Lappeenranta University of Technology/LUT Energy  
Finland*

## 1. Introduction

Mobile working machines play an important role in modern industry. These machines are widely used for instance in the mining, process and goods manufacturing industry, forest harvesting and harbour terminal work. Figure 1. illustrates typical examples of mobile working machines.



Fig. 1. Examples of mobile working machines: a) straddle carrier, b) forklift truck and c) mine underground truck. (Minav, 2011d)

Mobile working machines can be classified as light mobile machines that operate by battery power and heavy machines that work using a diesel engine. Both of these types include mechanical structures, which are driven by hydraulics. With the rising concern in global scale environmental issues, energy saving in vehicles and mobile machines is an important subject and reduction of fuel consumption is strongly required (Petrone, 2010 ; Saber, 2010 ; Bhattacharya, 2009 ; Montazeri-Gh, 2010 ; Mapelli, 2010, Liu, 2010). Hybrid propulsion concepts in working machines are emerging to improve their fuel economy and reduce CO<sub>2</sub> emissions (Fakham, 2011; Hui, 2010, Paulides, 2008). In addition, now there are government mandated Tier IV reduction regulations for harmful exhaust gases for diesel powered

equipment (Wagner, 2010; EPA, 2011). According to (Kunze, 2010), a hydraulic hybrid can be considered the greatest innovation potential for the industrial sector. Traditional hydraulic systems' control methods are giving way to direct electric-drives-based control of hydraulic force (Grbovic, 2011; Berkner, 2008;). Hydraulics is one of the widely adopted engineering approaches as it provides high force densities (Burrows, 2005), but its efficiency is often limited by lossy control methods but nowadays we have an opportunity to reduce the power losses by using an efficient electric drive system together with the hydraulic part of a mobile machine (Ahn, 2008; Iannuzzi, 2008). Improving working machines' efficiencies has attracted a lot of attention among researchers and manufacturers all over the world (Yang, 2007; Liang, 2001; Rahmfeld, 2001; Rydberg, 2005; Innoe, 2008; Mattila, 2000). A great number of different types of non-road machines are manufactured for different purposes. Typically, non-road vehicles can be classified as construction machines, transportation of goods or material handling equipment, and janitorial and agricultural machines. Regeneration-capable hydraulic systems that are based on combinations of an electromechanical unit and a reversible hydraulic machine have the potential of improving the energy efficiency by operating the system components within their optimum efficiency ranges and, especially, by making use of the regenerative processes in all the above-mentioned machines (Yoon, 2009). Forklift is one of the machine types that can be modified for energy recovery. Energy recovery is an efficient way to extend the driving range with limited energy sources (Minav, 2009; Andersen, 2005, Lin, 2010b; Rydberg, 2007).

There is a wealth of literature focused on the energy flow control of hybrid electric vehicles (Moreno, 2006), but publications devoted to the analysis of the electric and hydraulic parts of the vehicles are relatively rare. Energy efficiency and the analysis of losses are, however, gaining importance in all fields. This paper first addresses the idea of direct electric drive control of a hydraulic system and then in more details the effect of the type of the electric machine on the efficiency of an electric energy recovery system of a forklift.

First, the scheme and principle of the novel energy recovery system are described, and then, a theoretical evaluation of the system is performed step by step. A theoretical estimation of the motor efficiency was carried out for two different motor types. The differences in the energy efficiency between the two motors used in the test setup are discussed. Finally, conclusions are given.

## 2. Overview of the test setup

Traditional light forklifts use accumulators to supply electric energy. The lifting control is often based on valve-controlled hydraulic servo systems (Jelali, 2003). The experimental test setups on which the work is based are illustrated in Fig. 2. There are two setups to evaluate the effect of electric machine itself on the energy efficiency in a forklift. The setups are based on a commercial battery operated forklift, equipped either with a low voltage permanent magnet synchronous motor drive or with a safe voltage induction motor drive. The control of the experimental setup is quite different from traditional forklifts as it uses a speed-controlled electric servo drive rotating a hydraulic machine in both rotating directions to directly control the amount of hydraulic oil flow in the system. (Minav, 2008)

In the first (I) experimental case, the system has a network supply instead of a motor-generator set common in higher power hybrid drives. The rest of the components in the case of network supply are: 400 V electric machine frequency converter ACSM1 by ABB, a 400 V permanent magnet electric machine, a hydraulic pump capable of operating also as a motor,

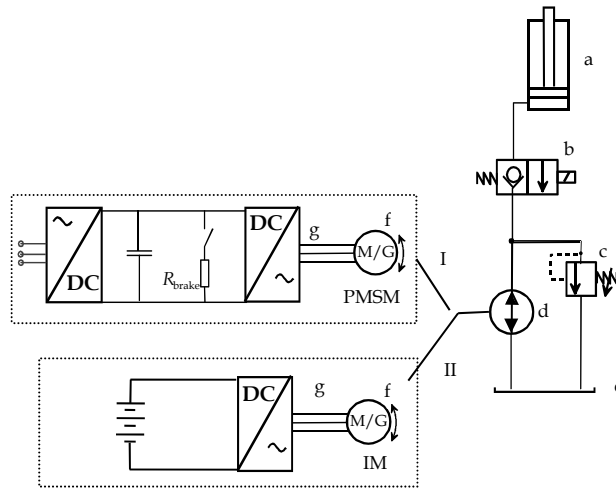

Fig. 2. Structures of the hydraulic and electric system to be tested. The experimental system consists of: a) single-acting cylinder, b) two-way normally closed poppet valve, c) pressure relief valve, d) hydraulic machine acting both as a pump or a motor, e) oil tank, f) electric machine operating both as a motor or a generator, g) frequency converter, and brake resistor  $R_{\text{brake}}$  (Minav, 2008).

a two-way normally closed poppet valve, an pressure relief valve, and a hydraulic cylinder. In the second (II) safe voltage case the 34 V motor was an induction motor manufactured by Danaher Motion and the converter manufactured by ZAPI. The battery voltage was 48 V. The hydraulic pump with a certain displacement moves a certain amount of oil from the tank to the rest of the hydraulic circuit where the piston should have a corresponding movement. The pump raises the oil pressure to the level required by the load. The flow runs through a two-way, normally closed poppet valve (b), which is here referred to as a control valve. Its role is to prevent accidental uncontrolled fast lowering of the load. The hydraulic pump produces a flow depending on the displacement of the pump and the rotating speed of the servo motor. A pressure relief valve (c) keeps the pressure under a maximum level in the system. The unique feature of the energy recovery system is that the oil travels through the system through the same route when lifting and lowering a load. While lowering a mass, the potential energy of the load produces a flow that rotates the hydraulic machine as a motor, and the mechanically connected electric motor acts as a generator, which is controlled by the frequency converter. Hence, the generator controls the amount of fluid flow and the position of the fork during lowering, instead of traditional valve control without energy recovery. Here, the converter rectifies the generated electric energy to the DC link where an accumulator should be in the case of a hybrid drive.

An upper level controller controls both the electrical and hydraulic parts of the forklift system. The performance of the system can, therefore, be easily controlled at different speeds when lifting or lowering masses. The system recovers as much energy as possible during a lowering movement. The test setup was equipped with pressure, current and voltage measurement sensors to define the efficiencies of the different parts of the system.

An example of the measured data for an internal gear pump is shown in Figures 3–5. In Figure 3 is shown the measured speed and current of the PMSM. The torque is the estimated torque of the PMSM.  $U_{dc}$  is the DC voltage in the DC link of the ACSM1, and the RO status shows the position of the relay that controls the two-way normally closed poppet valve.

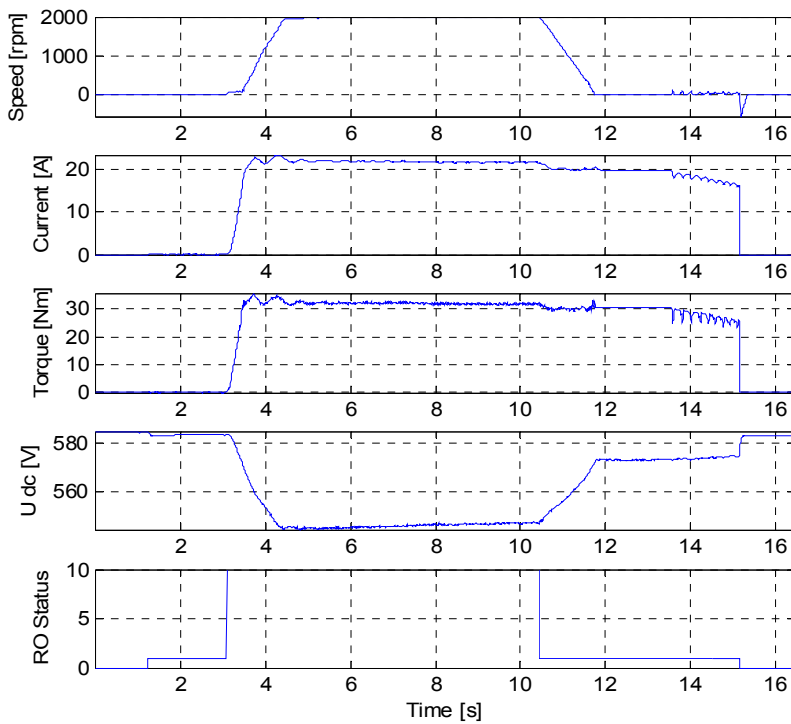

Fig. 3. Example of the data from the ACSM1 frequency converter (Minav, 2011d).

Figure 4 shows the measured phase voltages and currents measured with the Yokogawa PZ4000 power analyzer.

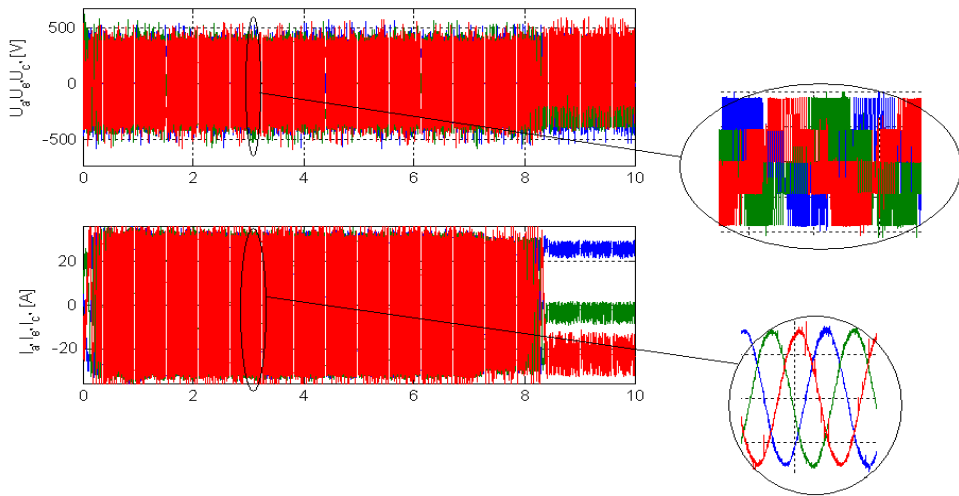

Fig. 4. Example of the data measured with the Yokogawa PZ4000 power analyzer (Minav, 2011d).

Figure 5 shows an example of measured DC current and DC voltage from the DC link with the Yokogawa PZ4000 power analyzer during a lowering motion.

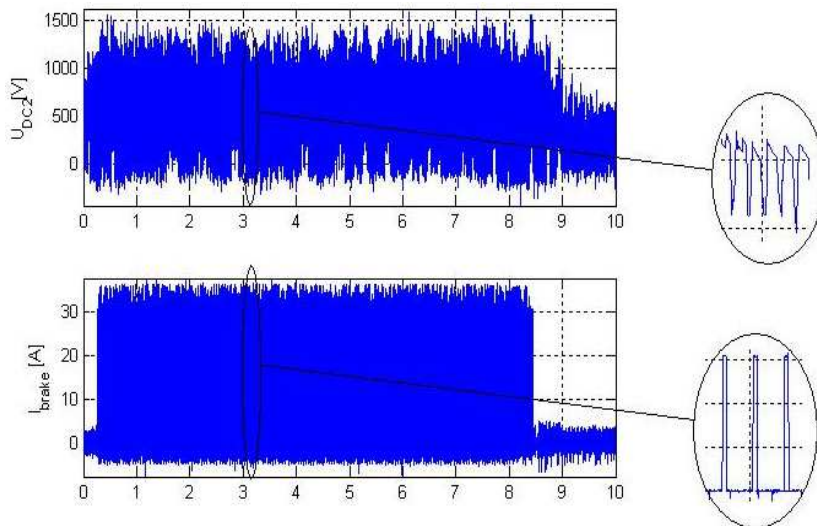

Fig. 5. Example of the measured DC current and DC voltage with the Yokogawa PZ4000 power analyzer during a lowering motion (Minav, 2011d).

### 3. Theoretical model of the system

The efficiency evaluation of the test setup is based on theoretical information from the literature and the material provided by manufacturers. With a theoretical model, it is possible to track the problem points in a setup and find targets to improve the performance of the system. The energy efficiency of the proposed hydraulic system was calculated as

$$\eta_{\text{SYS}} = \eta_{\text{inv}} \cdot \eta_{\text{EM}} \cdot \eta_{\text{HM}} \cdot \eta_{\text{VP}} \cdot \eta_{\text{G}} \cdot \eta_{\text{C}}, \quad (3.1)$$

where the subscript INV denotes the inverter, EM the electric machine, HM the hydraulic machine, VP the valves and pipes, G the mechanical gears, and C the hydraulic cylinder.

#### 3.1 Electric machine

By and large, the most significant contributors to the described hydraulic lifting system efficiency are the pump and the electrical machine. Two different machine types were chosen to be evaluated. The first is a permanent magnet synchronous servo motor that was chosen for the application because of its high efficiency and high overload capability. The servo motor used in the tests was a 10 kW PMSM (CFM112M) motor by SEW-Eurodrive with 30 Nm nominal torque, 10 A nominal current, 108 Nm maximum torque, and 80 A maximum current (SEW, 2007). The second machine is an induction motor Danaher Motion TSP112/4-150-T 3-Phase AC with 56 Nm nominal torque, 88 Nm maximum torque, and 241 A rated current (Danaher, 2011). The different machine types with different voltages can be fairly compared as the voltage level itself does not affect the efficiency of the drive. Actually, the MOSFET based ZAPI converter has a slightly higher efficiency (c. 99 % at the rated point) than the 400 V IGBT converter (c. 98 % at the rated point). The electric power loss analysis is based on the testing and redesign of the PMSM and the IM (Pyrhönen, 2008). A detailed description and calculations using the machine parameters measured in a fixed temperature for the PMSM are given in (Minav, 2011a). The PMSM data including the manufacturer's data, measured and calculated motor parameters are shown in Table 3.1.

Parameter	Value
Rated power, kW	10
Rated voltage, V	400
Rated speed, rpm	3000
Rated current, A	10
Number of stator slots	36
Air gap, m	0.0012
Rotor diameter, m	0.0882
Outer diameter, m	0.17
Rotor length, m	0.1193
Number of pole pairs	3

Table 3.1. PMSM motor parameters.

Figure 6 shows the calculated efficiency of the PMSM CFM112M with some measured efficiency points.

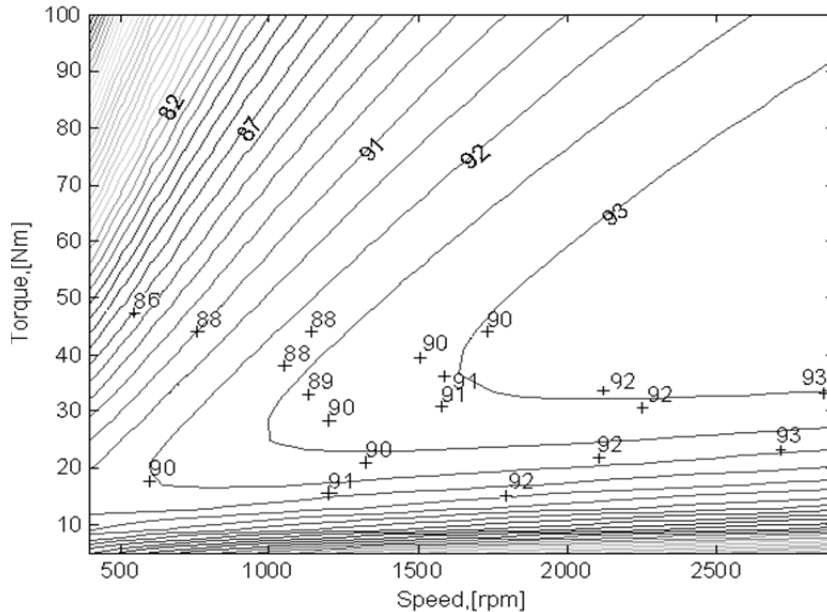

Fig. 6. Efficiency of the 10 kW CFM112M PMSM (solid line). Some measured efficiency points in lifting are indicated by + signs (Minav, 2011a).

A procedure similar to (Minav, 2011a) to produce theoretical system efficiency was performed for the induction machine test setup. This induction machine is the original safe voltage induction motor with which the lifting function of the original battery operated forklift was equipped. The electric power loss analysis for the IM is based on testing and redesign of the machine based on (Pyrhönen, 2008). The IM motor parameters are shown in Table 3.2.

Parameter	Value
Rated power, kW	10
Rated voltage, V	34
Rated speed, rpm	2300
Synchronous speed, rpm	2400
Rated current, A	241
Number of stator slots	36
Number of rotor slots	46
Air gap diameter, m	0.1101
Rotor diameter, m	0.1096
Outer diameter, m	0.204
Rotor length, m	0.15
Number of pole pairs	2

Table 3.2. IM motor parameters (Galkina, 2008; Danaher, 2011)

The resistive losses of the stator, also known as copper losses, are calculated as

$$P_{\text{Cus}} = 3 \cdot R_s \cdot I_s^2, \quad (3.2)$$

where  $P_{\text{Cus}}$  is the stator winding copper loss (W),  $R_s$  is the stator AC resistance ( $\Omega$ ) in the average operating temperature, and  $I_s$  the stator current (A). The resistive losses of the rotor are calculated as follows:

$$P_{\text{Cur}} = 3 \cdot R'_r \cdot I_r'^2, \quad (3.3)$$

where  $P_{\text{Cur}}$  is the rotor winding copper loss (W),  $R'_r$  is the rotor AC resistance ( $\Omega$ ) referred to the stator in the average operating temperature, and  $I_r'$  is the rotor current (A) referred to the stator.

The secondary losses comprise the core losses and the additional losses. The largest contribution to the secondary losses is due to the harmonic energies generated when the motor operates under load. These energies are dissipated as currents in the copper windings, harmonic flux components in the iron parts, and as leakages in the laminate core. The core losses at the rated point are:

$$P_{\text{Fe}} = 3 \cdot \frac{|E_m|^2}{R_{\text{Fe}}(f)}, \quad (3.4)$$

where  $R_{\text{Fe}}$  is the core loss resistance ( $\Omega$ ) and  $E_m$  is the air gap voltage (V), calculated by

$$E_m = \underline{U}_{\text{sph}} - I_s \cdot \underline{Z}_s \quad (3.5)$$

Where  $\underline{U}_{\text{sph}}$  is the phase voltage (V) and  $\underline{Z}_s$  is the stator circuit impedance ( $\Omega$ ) including the stator resistance and leakage. The Iron loss is frequency dependent as a function of  $f^2$  which is taken into account in the efficiency calculations as a function of speed.

The additional losses in the IM were calculated as

$$P_{\text{ad}} = 3 \cdot |I_s| \cdot |\underline{U}| \cdot \cos\phi_x \cdot 0.5 \cdot 10^{-2}, \quad (3.6)$$

The sum of losses  $P_{\text{Los}}$  in the IM machine are calculated as

$$P_{\text{Los}} = P_{\text{Cus}} + P_{\text{Cur}} + P_{\text{Fe}} + P_{\text{ad}}, \quad (3.7)$$

The efficiency  $\eta_{\text{IM}}$  of the electric machine is obtained by

$$\eta_{\text{IM}} = \frac{P}{P + P_{\text{Los}}} \cdot 100, \quad (3.8)$$

where  $P$  is the shaft power (W).

Calculations based on (3.2–3.8) were repeated for a fixed torque for all speeds. The machine parameters, except the iron loss resistance, were kept as constants calculated in the rated operating point.

Figure 7 shows the calculated efficiency of the IM with the measured efficiency points. The measured points indicate that the modelling has been fairly accurate for this purpose



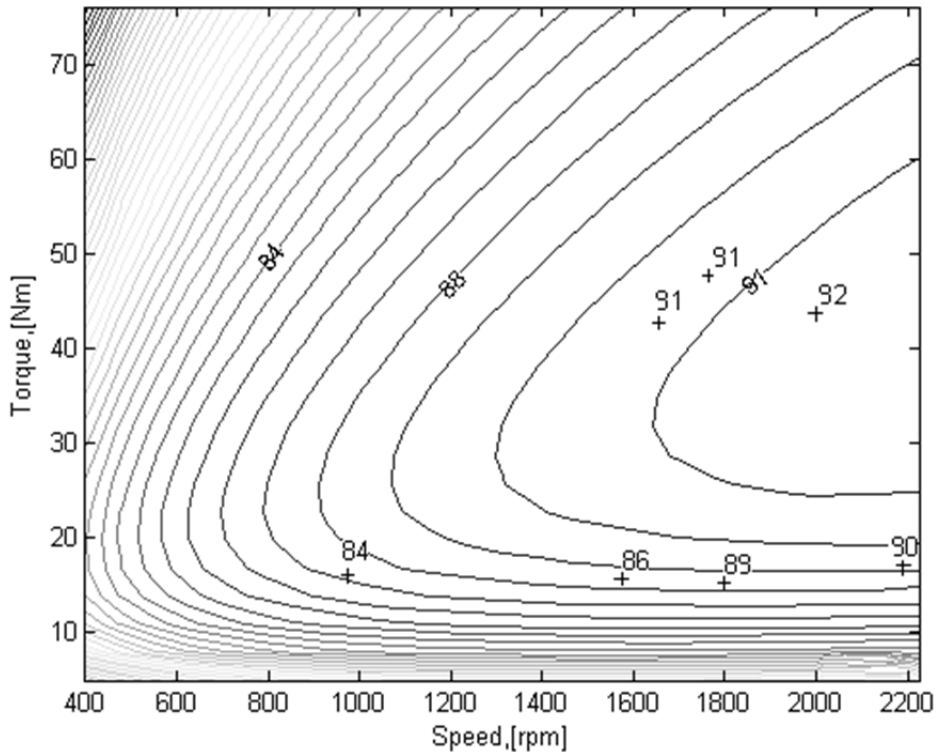

Fig. 7. Efficiency of the 10 kW IM (solid line). Some measured efficiency points in lifting are indicated by + signs.

### 3.2 Frequency converter

In the experimental test setup I, a servo motor inverter ACSM1 by ABB was used. The ACSM1 high-performance machinery drive provides speed, torque, and motion control for the PMSM. The ACSM1 can control servo motors with or without feedback of the motor speed. It uses Direct Torque Control (DTC) motor control technology to guarantee high performance (Pyrhönen, 1998). The maximum possible efficiency of the ACSM1 frequency converter is in the range of 98 % (ABB, 2007). In the experimental test setup II, a motor converter with MOSFET switches manufactured by ZAPI was used.

### 3.3 Hydraulic machine and system

In the experiments, we used an internal gear pump with a fixed displacement, as the hydraulic machine is capable of working also as a motor (Erkerle, 2007). Machines of this type are highly efficient in the tested operation range (Minav, 2011c). Fig. 8 gives the efficiencies of continuous-travelling positive displacement machines. A pressure of 12 MPa corresponds to the maximum tested 920 kg payload. At this point the internal gear pump has the efficiency of 84 %. A pressure of 5 MPa corresponds to 0 kg payload in our test arrangement, and the internal gear pump has the efficiency of 87 % at this point.

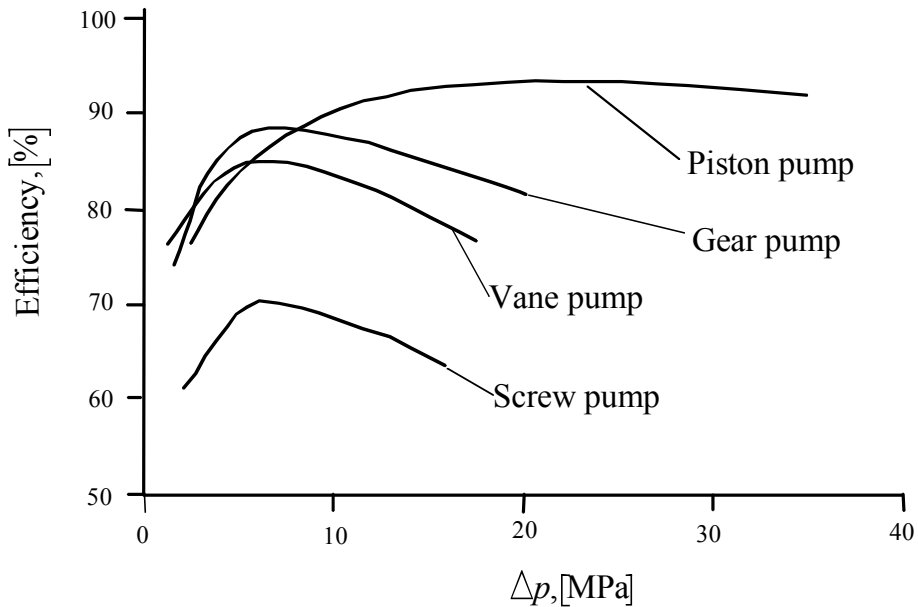

Fig. 8. Comparison the of the efficiencies of different hydraulic pumps operating at constant speed (Minav, 2011c).

The hydraulic losses in the piping systems consist of pipe friction losses in valves, elbows and other fittings, entrance and exit losses, and losses from changes in the pipe size by a reduction in the diameter. In our test setup, the power losses vary between 5-10 % depending on the operation mode. A single-acting cylinder is used in the experimental setup. It is known that the total seal friction of a hydraulic cylinder is 2-5 % of the total cylinder force (Majumdar, 2002). Based on the information from (Minav, 2011b), the cylinder efficiency was assumed to be 95 %. A mechanical chain gear is embedded in the fork construction. Its efficiency varies between 98 % and 99 %. Mechanical gears do not significantly affect the total efficiency, but the efficiency will be taken into account for calculating the system efficiency of the test setup.

The test setups in the two different cases are identical. Only the motor drives were different. Table 3.3 shows the differences in the motor efficiencies at different operating points.

Parameters		PMSM efficiency, [%]	IM efficiency, [%]	Difference, [%-units]
Speed, [rpm]	Torque, [Nm]			
500	15	91	80	11
	30	91	79	12
	45	86	76	10
1000	15	92	86	6
	30	92	88	4
	45	91	87	4
1500	15	90	87	3
	30	92	90	2
	45	92	90	2
2000	15	91	87	4
	30	92	91	1
	45	93	91	2

Table 3.3. Comparison of the efficiencies of the IM and the PMSM.

#### 4. Empirical results

The model shows that the IM is not very efficient compared with the PMSM, and the same result is observed in the figure below. Also, there exists a difference in the performance of the IM in motoring and generating modes (Fig. 9). Figure 9 shows an example of the measurement results of the system efficiency.

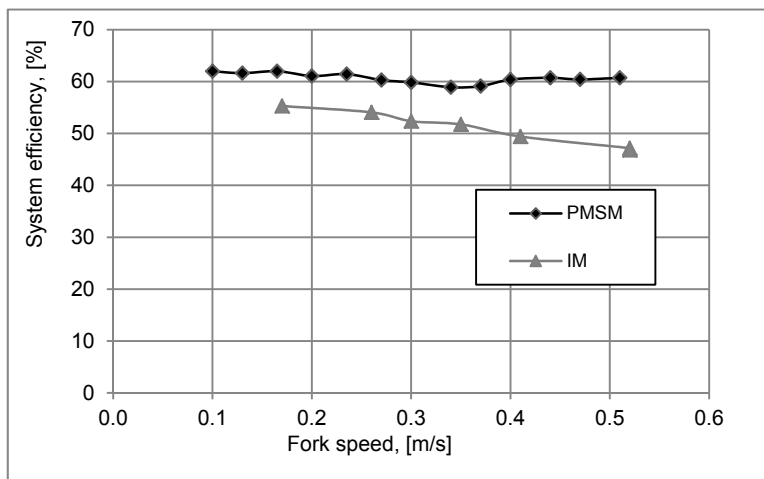

Fig. 9. System efficiency for lifting with 0 kg payload corresponding to 15 Nm shaft torque. In this case the PMSM brings clearly better results compared to the IM.

Figure 9 shows that the effect of the PMSM is significant. In lifting, the efficiency of the system can be improved from 50 % up to 60 %.

Figure 10 shows an example of the measurements of the system efficiency for lowering for different test setups.

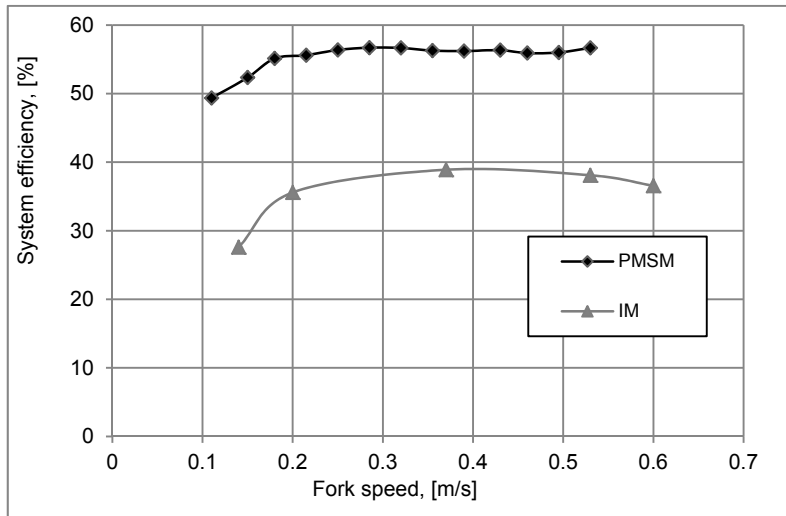

Fig. 10. System efficiency for lowering with 920 kg payload corresponding to 20 Nm shaft torque.

In lowering, the efficiency of the system can be improved from 40 % up to 60 %. It can be seen that in both cases (lifting and lowering), the PMSM setup has a significantly higher efficiency. Partly this high efficiency difference is based on a better matching of the PMSM properties to the load than the corresponding IM properties. The IM is selected according to S3 15 % operating principle and obviously suffers from under dimensioning in this case. However, in low power systems the permanent magnet excitation brings a big benefit from the energy efficiency point of view.

## 5. Conclusion

The energy efficiency of an electro-hydraulic forklift was studied. The hydraulic system and the electric parts of the working machine were evaluated and the theoretical approach was verified by practical experiments in order to determine the effect of the PMSM and the IM on the system efficiency. The energy recovered in the tests showed that the PMSM has a significant impact on the efficiency of the system. Our theoretical investigation predicted a possible improvement, which was then shown empirically. By choosing an appropriate motor, in this case the 10 kW PMSM, the total system efficiency can be improved during lifting even 14 percentage units and during lowering even 16 percentage units compared to the 10 kW IM. In lifting the best efficiency for IM was 58 % at low speed and zero payload. For PMSM, in lifting, the efficiency is higher, being around 60 % at all range of measured speeds. In lowering the system efficiency with PMSM varies from 49 % to 59 % with

increasing speed with 920 kg payload, being clearly higher than for the system with IM, where the system efficiency varies from 27 % to 39 %.

## 6. Acknowledgments

The research was enabled by the financial support of Tekes, the Finnish Funding Agency for Technology and Innovation, European Union, European Regional Development Fund and Regional council of South Karelia and FIMA (Forum for Intelligent Machines) at the Department of Electrical Engineering, the Institute of Energy Technology, Lappeenranta University of Technology.

## 7. References

- ABB: *Motion Control program Firmware*, 2007, <http://www.abb.com>, accessed November 13, 2007
- Ahn, K. K., Ho, T. H. and Dinh, Q. T. (2008). A study on energy saving potential of hydraulic control system using switching type closed loop constant pressure system. *In Proceedings of the 7th JFPS International Symposium on Fluid Power*, TOYAMA 2008 September 15–18, 2008.
- Andersen T. O., Hansen M. R., Pedersen H. C. and Conrad F., (2005), *Regeneration of potential energy in hydraulic forklift truck*, Proc. of the 6th International Conference on Fluid Power Transmission and Control, pp. 302–306, Hangzhou.
- Berkner, P. (2008). How, Why, and When to apply electric motors to mobile hydraulic systems. In Parker Hannifin 2008 Global Mobile Sales Meeting & Symposium Whitepaper # 0001., [Online], [Accessed January 10, 2010]. Available at: <http://www.allaboutmotion.com>
- Bhattacharya T., Giri V. S., Mathew V., Umanand L., (2009), Multiphase Bidirectional Flyback Converter Topology for Hybrid Electric Vehicles, *IEEE Trans. Ind. Electron.*, vol. 56, no. 1, pp. 78-84, Jan. 2009.
- Burrows, C. R. (2005). Control and condition monitoring in electro-hydraulic systems. *In UKACC Control 2004 Mini Symposia*. [Online]. Available at: <http://www.ieee.com>.
- Danaher Motor, TSP112/4-150-T3 product datasheet, (2011) [http://www.danahermotion.co.jp/products/files/AC\\_motor\\_sec.pdf](http://www.danahermotion.co.jp/products/files/AC_motor_sec.pdf), accessed September 10, 2011.
- EPA (2011). *Clean Air Nonroad Diesel - Tier 4 Final Rule*, [Online], [Accessed 14 January 2010] available at: <http://www.epa.gov/nonroadiesel/2004fr.htm>.
- Fakham H., Lu D., Francois B., (2011), Power Control Design of a Battery Charger in a Hybrid Active PV Generator for Load-Following Applications, *IEEE Trans. on Industrial Electronics*, vol. 58, no. 1, pp.85 - 94, January 2011
- Galkina A., (2008), *System onvestigation for hybrid electric vehicle*, Master's thesis, Dept. Electrical Eng., Lappeenranta University of Technology. , 80 pages.
- Grbovic P. J., Delarue P., Le Moigne P., Bartholomeus P., (2011), The Ultracapacitor-Based Controlled Electric Drives With Braking and Ride-Through Capability: Overview and Analysis, *IEEE Trans. on Industrial Electronics*, vol. 58, no. 3, pp.925 - 936, March 2011

- Hui, S. and Junqing, J. (2010). Research on the system configuration and energy control strategy for parallel hydraulic hybrid loader. *Journal Automation in Construction*, Vol. 19, Issue 2, March 2010, pp. 213–220.
- Iannuzzi, D. (2008). Improvement of the Energy Recovery of Traction electrical drives using supercapacitors. In *Proceedings of the 13th International Power Electronics and Motion Control Conference*.
- Inoue, H. (2008). *Introduction of PC200-8 Hybrid Hydraulic Excavators*. [Online]. Available at: <http://www.komatsu.com/CompanyInfo/profile/report/pdf/161-E-05.pdf>.
- Jelali M., (2003,) *Hydraulic servo systems Modeling, identification and control*, Springer, 2003,p. 355.
- Kunze, G. (2010). *Mobile construction machinery-trends and new developments*. ATZonline. April 2010. [Online]. available at: <http://www.atzonline.com>.
- Liang X. and Virvalo T., (2001) *What's wrong with energy utilization in hydraulic cranes*, Proc. 5th international conference on fluid power transmission and control, Hangzhou, China.
- Lin, T., Wang, Q., Hu, B. and Gong W. (2010a). Development of hydraulic powered hydraulic construction machinery. *Journal Automation in construction*. Vol. 19, issue 1, January 2010, pp. 11–19.
- Lin, T., Wang, Q., Hu, B. and Gong, W. (2010b). Research on the energy regeneration systems for hydraulic excavators. *Journal Automation in construction*. Vol. 19, issue 8, December 2010, pp. 1016–1026.
- Liu C., Chau K.T., Jiang J.Z.,(2010), A Permanent-Magnet Hybrid Brushless Integrated Starter–Generator for Hybrid Electric Vehicles , *IEEE Trans. Ind. Electron.*, vol. 57, no.12, Dec. 2010.
- Majumdar, S. R. (2002). *Oil Hydraulic Systems principles and maintenance*. New York: McGraw-Hill.
- Mapelli F. L., Tarsitano D., Mauri M., (2010), Plug-In Hybrid Electric Vehicle: Modeling, Prototype Realization, and Inverter Losses Reduction Analysis , *IEEE Trans. Ind. Electron.*, vol. 57, no. 2, Feb. 2010.
- Minav T., (2008), *Electric energy recovery system for a hydraulic forklift*, Master's thesis, Dept. Electrical Eng., Lappeenranta University of Technology, 70 pages.
- Minav T., Laurila L., and Pyrhönen J. ,(2011a), *Permanent Magnet Synchronous Machine Sizing: Effect on the Energy Efficiency of an Electro-hydraulic Forklift*, *Transactions on Industrial Electronics*, in press.
- Minav T., Laurila L., Immonen P., Pyrhönen J., Vtorov V. and Niemelä M.,(2011b) *Electric energy recovery system for a hydraulic forklift – theoretical and experimental evaluation*, *IET Electric Power Applications*, Vol.5, issue 4, Apr. 2011. pp. 377–386.
- Minav T., Laurila L., Pyrhönen, J. and Vtorov V., (2011c), *Direct pump control effects on the energy efficiency in an electro-hydraulic lifting system*, *Journal International Review of Automatic Control*, Vol.4, n.2, March 2011.
- Minav T.A., (2011d), *Electric-drive-based control and electric energy regeneration in a hydraulic system*, Ph.D. dissertation, Dept. Elect. Eng, Lappeenranta University of Technology, Acta Universitatis Lappeenrantaensis 436, Lappeenranta, Finland, 2011.

- Minav T.A., Laurila L. I. E., Immonen P., Haapala M. and Pyrhönen J. J., (2009). Electric energy recovery system efficiency in a hydraulic forklift, *Proceedings of the EUROCON 2009, St.Petersburg, Russia, 2009*.
- Montazeri-Gh, M. Soleymani, M., (2010) Investigation of the Energy Regeneration of Active Suspension System in Hybrid Electric Vehicles , *IEEE Trans. Ind. Electron.*, vol. 57, no. 3, March 2010.
- Moreno J., Ortúzar M. E. and Dixon J. W., (2006), *Energy-Management System for a Hybrid Electric Vehicle*, Using Ultracapacitors and Neural Networks, *IEEE Trans. Ind. Electron.*, vol. 53, no. 2, April 2006.
- Petrone G. A., Spagnuolo G., Vitelli M.,(2010), Low-Frequency Current Oscillations and Maximum Power Point Tracking in Grid-Connected Fuel-Cell-Based Systems, *IEEE Trans. Ind. Electron.*, vol. 57, no. 6, pp. 2042, June 2010.
- Pyrhonen J., Jokinen T. and Hrábovcová V., (2008), *Design of rotating electrical machines* , John Wiley & Sons, 2008, p.538 .
- Pyrhonen J., Niemela M., Kaukonen J., Luukko J. and Pyrhonen O., (1998), *Test results with the Direct Flux Linkage Control of Synchronous machine*, *Aerospace and Electronic Systems Magazine*, IEEE, vol. 4, pp. 23-27, Apr. 1998.
- Rahmfeld, R. and Ivantysynova, M., (2001), *Displacement Controlled Linear Actuator with Differential Cylinder - A Way to Save Primary Energy in Mobile Machines*. In *Proceedings of 5th International Conference on Fluid Power Transmission and Control (ICFP'2001)*, Hangzhou, China, pp. 316-322.
- Rydberg, K.-E. (2005). Energy Efficient Hydraulic Systems and Regenerative Capabilities. In *Proceedings of the Ninth Scandinavian International Conference on Fluid Power SICFP'05*. Linköping.
- Rydberg, K.-E. (2007). Design of Energy Efficient Hydraulic Systems - System Concepts and Control Aspects. In *Proceedings of the 5th International Symposium on Fluid Power Transmission and Control*. Beidaihe, China.
- Saber A. Y., and Venayagamoorthy G. K.,(2010) Plug-in Vehicles and Renewable Energy Sources for Cost and Emission Reductions , *IEEE Trans. Ind. Electron.*, in press, Dec. 2010.
- SEW Drive Engineering-Practical Implementation. <http://www.sew-eurodrive.com>, accessed November 13, 2007.
- Wagner. (2010). *Tier IV emissions regulations: Knowing the facts*. [Online]. Available at: <http://www.wagnerequipment.com>.
- Yang H., Sun W., and Xu B., (2007), New Investigation in Energy Regeneration of Hydraulic Elevators, *IEEE/ASME Transactions on Mechatronics*, vol. 12, n. 5, October 2007
- Yoon J.I., Kwan A. K., Truong D. Q., (2009), *A Study on An Energy Saving Electro-Hydraulic Excavator*, Proc. ICROS-SICE International Joint Conference 2009, Fukuoka, Japan, August 18-21.
- Mattila, J. (2000). *On Energy-efficient motion control of hydraulic manipulator*. Doctoral thesis, Publications 312, Tampere University of Technology.
- Paulides, J. J. H., Kazmin, E. V., Gysen, B. L. J. and Lomonova, E. A.(2008). Series Hybrid Vehicle System Analysis Using an In-Wheel Motor Design. In *Proceedings of the*

IEEE Vehicle Power and Propulsion Conference (VPPC), September 3-5, Harbin, China.

Eckerle (2007) Hydraulic division. EIPS 2 Internal gear pumps.[Online]. [Accessed 20 April 2008], available at: <http://www.eckerle.com>.



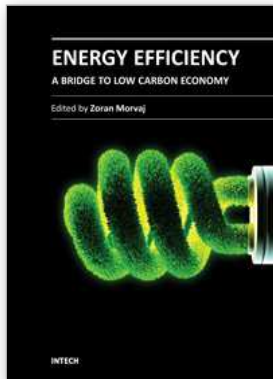

## **Energy Efficiency - A Bridge to Low Carbon Economy**

Edited by Dr. Zoran Morvaj

ISBN 978-953-51-0340-0

Hard cover, 344 pages

**Publisher** InTech

**Published online** 16, March, 2012

**Published in print edition** March, 2012

Energy efficiency is finally a common sense term. Nowadays almost everyone knows that using energy more efficiently saves money, reduces the emissions of greenhouse gasses and lowers dependence on imported fossil fuels. We are living in a fossil age at the peak of its strength. Competition for securing resources for fuelling economic development is increasing, price of fuels will increase while availability of would gradually decline. Small nations will be first to suffer if caught unprepared in the midst of the struggle for resources among the large players. Here it is where energy efficiency has a potential to lead toward the natural next step - transition away from imported fossil fuels! Someone said that the only thing more harmful than fossil fuel is fossilized thinking. It is our sincere hope that some of chapters in this book will influence you to take a fresh look at the transition to low carbon economy and the role that energy efficiency can play in that process.

### **How to reference**

In order to correctly reference this scholarly work, feel free to copy and paste the following:

Tatiana Minav, Lasse Laurila and Juha Pyrhönen (2012). Effect of an Electric Motor on the Energy Efficiency of an Electro-Hydraulic Forklift, *Energy Efficiency - A Bridge to Low Carbon Economy*, Dr. Zoran Morvaj (Ed.), ISBN: 978-953-51-0340-0, InTech, Available from: <http://www.intechopen.com/books/energy-efficiency-a-bridge-to-low-carbon-economy/effect-of-electric-motor-on-the-energy-efficiency-of-the-electro-hydraulic-forklift>

# **INTECH**

open science | open minds

### **InTech Europe**

University Campus STeP Ri  
Slavka Krautzeka 83/A  
51000 Rijeka, Croatia  
Phone: +385 (51) 770 447  
Fax: +385 (51) 686 166  
[www.intechopen.com](http://www.intechopen.com)

### **InTech China**

Unit 405, Office Block, Hotel Equatorial Shanghai  
No.65, Yan An Road (West), Shanghai, 200040, China  
中国上海市延安西路65号上海国际贵都大饭店办公楼405单元  
Phone: +86-21-62489820  
Fax: +86-21-62489821

© 2012 The Author(s). Licensee IntechOpen. This is an open access article distributed under the terms of the [Creative Commons Attribution 3.0 License](#), which permits unrestricted use, distribution, and reproduction in any medium, provided the original work is properly cited.