

New Approaches for Treatment and Prevention of Aortic Aneurysms

Stefano Nazari
*Foundation Alexis Carrel, Pavia,
 Italy*

1. Introduction

1.1 Background

1.1.1 The beginning

Vascular surgery was quite obviously conditioned by the development and evolution of the techniques for vascular anastomosis, started around the beginning of the past century. Apart in fact from few episodic and lucky clinical cases of lateral laceration repair as well as many experimental endeavours of vascular suture, accurately described and illustrated in a detailed historical Italian review (Zannini G 1967), before that point in time vascular surgery clinical practice was substantially confined to vascular ligation.

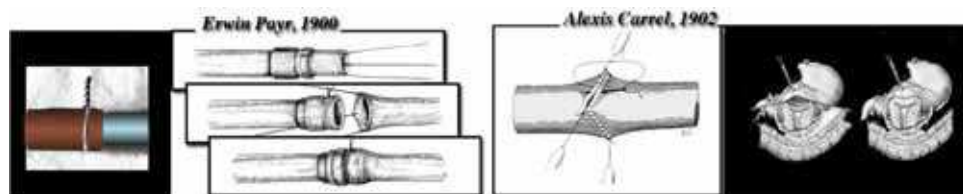

Fig. 1. Payr and Carrel pioneering techniques.

Payr first reported device for vascular anastomosis substantially derived from elaboration of the common method for rubber tubing connection (left square) while Carrel triangulation was apparently derived from refinements of gastrointestinal suture (right square).

In 1900 Erwin Payr reported to the German Surgical Society results on animal experiments of the apparently first device for vascular anastomosis, which is essentially based on external legature of vascular stumps over a rigid and absorbable magnesium ring (Payr E, 1900), thus trying to adapting to surgery a method already universally used for coupling floppy/elastic tubing. In spite of its elegance (intima-to-intima facing, absorbable magnesium ring) one of its implicit mechanical limits was already outlined in the original report: elastic retraction of the vascular wall when clamped significantly reduces its diameter, thus making quite difficult to put in place a rigid ring of appropriate diameter.

In those very years Alexis Carrel, as well as many others in fact (Zannini G 1967), was focusing his attention on suture techniques, already currently adopted in the gastrointestinal tract, and was able to realize blood-tight, low thrombogenic vascular anastomoses by careful refinements of the needles, threads and techniques for their use

(Carrel A, 1902, 1907), thus establishing the standard technique of vascular surgery. Although technically demanding, its versatility allowed to deal with virtually all clinical occurrences, from large aortic to microsurgical anastomosis, so that the many and significant improvements in needles (i.e. curved, atraumatic), threads (i.e. polypropylene) and surgical technique (i.e. parachute, etc) developed throughout more than a century could not break the ideal line linking the Nobel prize acknowledged (1912) Carrel original work with today clinical practice.

Interestingly enough for more than a century vascular anastomosis technique research moved forward, very slowly to say the truth, with occasional brief clinical applications essentially along these two basic principles only, with the possible exception of gluing based methods.

1.2 Vascular staplers

It was in fact substantially a technological evolution of the Carrel coupling principle (full thickness wall stump stitching) that gave origin, around the middle of the past century, to stapling devices with the aim of automating the anastomoses.

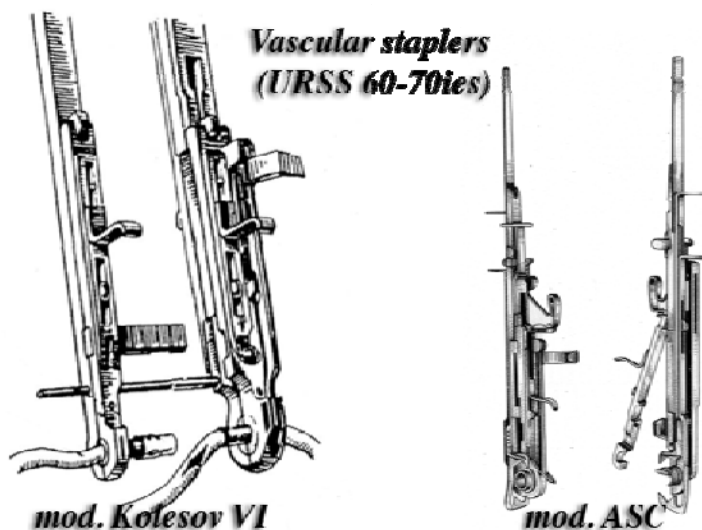

Fig. 2. Models of URSS vascular staplers (1960-70).

Similar bulky and cumbersome devices were also realized at that time in Canada, USA and Japan.

However, while stapling devices have long since allowed standardization and simplification of digestive tract circular anastomosis, despite extensive research (see exhaustive reviews: Tesauro 1967; Tesauro & Persico 1979), including our own (Nazari S et al, 1990), the stapling principle has so far failed to be of significant use for vascular anastomosis, which remains substantially the only basic surgical task still to be automated.

The 60-70ies stapling devices (fig 2) have all quite cumbersome and heavy configuration in particular in relation to the delicate structure of the quite small diameter vessel to which they were intended to be used in those years.



Fig. 3. Vascular stapler for reducing warm ischemia in organ transplantation. With our model each stapler end can be mounted on donor and recipient by independent surgical teams without care for reciprocal orientation, being the maximal possible vascular axis torsion $\leq 30^\circ$. Activating guide-wire is connected just immediately before firing (Nazari et al 1990). Video at <http://www.fondazione-carrel.org/tsb2/tsb2.html>

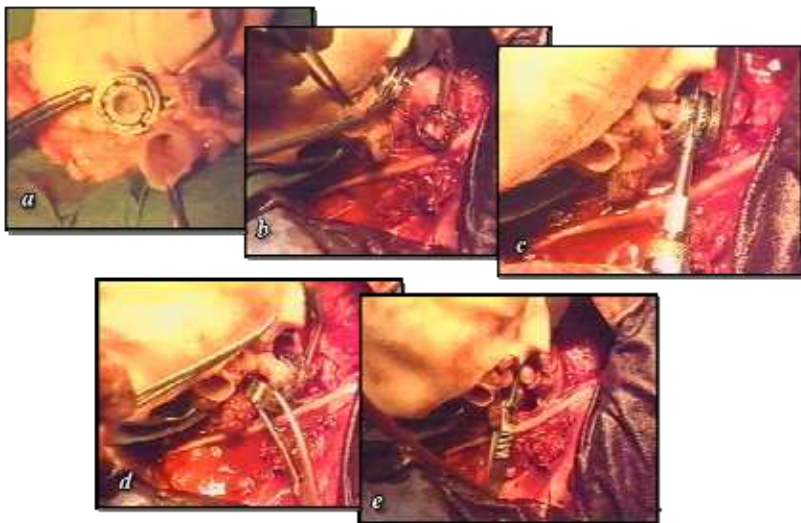

Fig. 4. Vascular stapler for reducing warm ischemia in experimental lung transplantation. In a canine model of left single lung transplantation one stapler end was applied on donor pulmonary artery at back table (a) and the other by the recipient surgical team; then the two ends are quickly connected together (b), the firing wire connected and activated (c). After having sectioned the two sutures linking the vascular stumps to the device ends, the two stapler parts were divided and removed (d) and anastomosis checked (e) still preventing graft perfusion until atrial connection was established (Nazari et al 1990). Video at <http://www.fondazione-carrel.org/tsb2/tsb2.html>

With this in mind first of all we tried to simplify the procedure by severing the stapling device (fig 3) from the activating handle, which in our device consisted in a flexible, camera-type, firing guide-wire that could be connected to the stapler after its coupling with vascular stumps just before firing (fig. 4,c), at the more convenient of the two opposite sides connectors (fig. 3). Moreover the two stapler parts were designed in such a way that each one could be mounted on the vascular stump by independent surgical teams without taking care for their reciprocal orientation; the connectors of the two parts of the stapler in fact allowed to limit the maximal possible vascular axis torsion to 30°.

One of the crucial points mechanically implicit in any vascular stapler model, is related to the requirement of temporary fixation of the vascular stumps to the device ends in preparation for the anastomosis. The vascular stump link to each device end in fact must be, on one side, strong enough to be maintained during device manipulation for ends coupling but, on the other side, should be weak enough to be easily released after stapler firing, to allow the device ends to be divided and removed.

Being our stapler ideated for use in organ transplantation to reduce the warm ischemic phase, we could solve this problem by temporarily suturing vascular stumps to the stapler end by single thread on predisposed little rings (fig 3, d); this can be done independently by the donor surgical team at back table to one stapler end (fig 4, a) and by the recipient team to the other stapler end, without interfering with time critical surgical phases. When the donor organ is at the recipient operative table (fig 4, b) the two stapler ends can be easily and quickly connected and the stapler fired (fig. 4,c). Only when the circulation is resumed the sutures temporarily connecting the vascular stumps to the stapler ends can be sectioned and the device removed (fig 4, d) without impacting on the organ warm ischemia time.

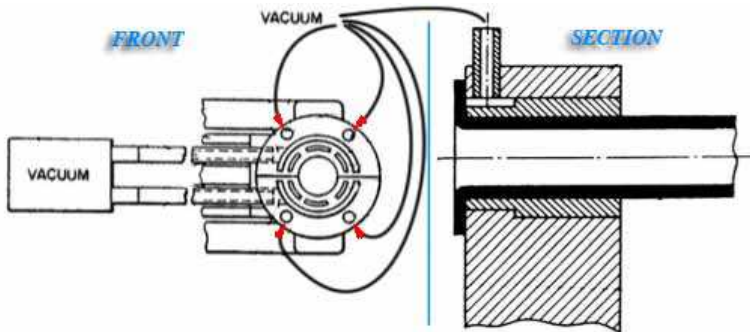

Fig. 5. Kolesov VI vacuum assisted vascular stapler.

To temporarily connect coronary artery stumps to the stapler ends, vacuum is applied to the predisposed device whose surface then sucks and holds the vascular wall (red arrows).

An elegant technical solution to this problem was provided by V. Kolesov (Kolesov VI et al 1970, 1991), credited for the first LIMA-coronary artery by pass (Konstantinov IE, 2004) and the first (and at this point in time the only one) surgeon to have clinically used coronary stapling device. He devised to realize this vascular stump-stapler end temporary link by applying vacuum to each device end whose surface was appropriately predisposed (Fig. 5, red arrows) thus sucking and holding the vascular stump in position. This seems a simple and effective method that can ideally fit with the surgical need and possibly solve this part of the vascular stapler problems.

In synthesis however, even though research restlessly continue to produce new prototypes, the apparently unavoidable critical point is that the intrinsic manual surgical skill required to put in position and operate any stapler on the delicate vascular structure didn't yet (can't?) result in a easier, simpler, quicker and more efficient task than standard hand suture, even when its use is for very large diameter vessel only (Takata et al 2011).

1.3 Intraluminal ringed prosthesis

In the 1970–1980s, a simplified Payr concept was revived with the introduction of intraluminal ringed prostheses, whose use in aortic substitution was quite extensively reported (Lemole et al, 1982; Berger et al, 1983; Crawford ES & JL, 1984).



Fig. 6. Intraluminal ringed prosthesis.

Aortic anastomotic device commercially available (FDA) in 70-90ies.

The reasons for their clinical failure have been numerous. Facts mechanically implicit in the method (fig 7) are related both to the elastic retraction of the vessel when is clamped, already outlined in the Payr report (Payr, 1900), and to the floppy consistency of the vascular wall that requires a further significant gap to be left between the clamped internal aortic wall and the external ring diameter to allow the ring to be easily slipped into the vascular stump without friction. Accordingly a ringed prosthesis with a diameter significantly smaller than appropriate must be used to keep the cross-clamping time shorter than that attainable with manual suturing (Nazari, 1996a). Thus when the aorta is reperfused, the resulting discrepancy between perfused vascular stump and intraluminal ring diameter generates conditions greatly favouring coupling instability (fig. 7, C); moreover possible generation of systolic movements of the aortic wall at ligature hinge may potentially cause mechanical friction/erosion and thus eventually rupture. (fig 7, D).

Many other inappropriate constructive features of those devices were probably responsible for their eventual failure. Thus the rigid ring was too short to be easily identified from outside the aorta, making very difficult the appropriate positioning of the external ligature; moreover the groove shape and dimension were inappropriate to maintain coupling stability.

This latter point offers the occasion for some important consideration. Vascular anastomosis must guarantee two essential mechanical facts: haemostatic sealing and stability of the coupling. This may seem a self-evident, unnecessary distinction since both are obviously provided at once by the standard hand suture; not so however with the "Payr" coupling principle, which is at basis of 70-80ies intraluminal prosthesis as well as of our expandable device.

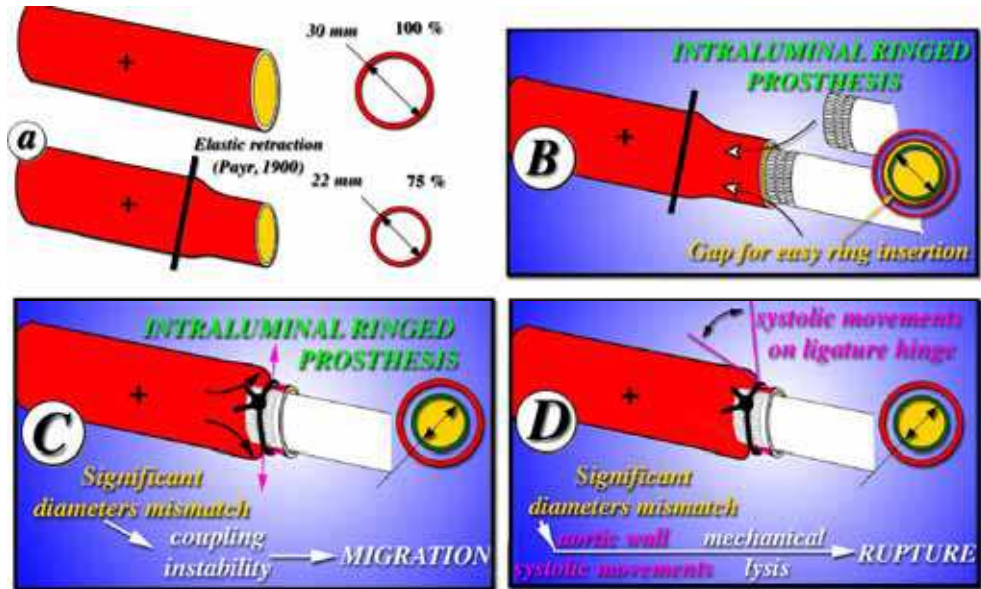

Fig. 7. Facts related to intraluminal ringed prosthesis (Payr type coupling). When the vessel is clamped there is a significant reduction of the stump diameter due to its elastic retraction (a); moreover because of the floppy consistency of the vascular wall a significant gap (b) must be left between outer ring and inner stump diameter for a rapid positioning. When blood flow is resumed the resulting significant diameter mismatch (c) generates conditions for coupling instability and device dislocation. It may also be hypothesized that systolic movements on ligature hinge (d) may generate mechanical erosion and possibly rupture.

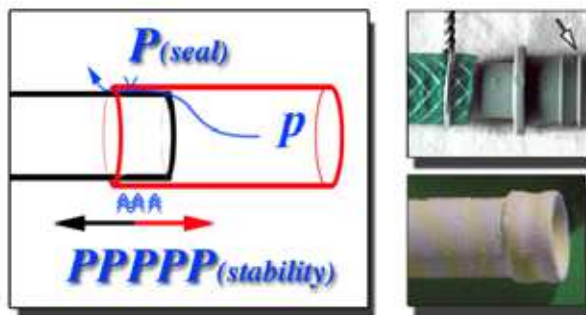

Fig. 8. Haemostasis and stability in Payr coupling type. While hemostasis can be achieved by applying an external pressure \geq blood pressure, even much higher pressure may not prevent the stump from slipping over the inner sleeve and split apart (larger square). Grooves on the inner sleeve outer surface can prevent dislocation only if appropriately dimensioned and shaped (right upper square). Intraluminal prosthesis groove appears inappropriate in deepness, length and shape to keep coupling stability (right lower square).

While in fact to achieve haemostatic seal is sufficient to apply on the vascular stump external surface a pressure equal or just exceeding the blood pressure, that pressure or even a much higher pressure may not be enough to prevent the vascular stump from slipping off from the inner sleeve (fig. 8, large square). Then means to increase friction (i.e. groove or hooks, etc) between the opposing surfaces or to permanently link them together (i.e. full thickness stitches) must be put in place to prevent vascular stump from sliding off. Although this was soon appreciated (and solved!) by gardeners since many years (fig. 8, upper right square), the failure of the 70-80ies intraluminal prosthesis may have been caused also by underestimation (fig. 8, lower right square) of this not irrelevant detail.

1.4 Endovascular surgery

In the last decade of the past century, preceded by pioneering work of C. Gianturco (Charnsangavej et al, 1985; Wright et al, 1985; Yoshioka et al, 1988) and popularized by J.C Parodi clinical reports (Parodi 1991, 1994), endovascular techniques burst into clinical vascular surgery, allowing prosthesis positioning into the aneurysm and excluding it from blood stream without open surgery. This provided a less invasive and lower complications rate therapeutic tool that allowed cure for patients previously not amenable to open surgery for age, general conditions or associated risk factors. First successfully popularized in infrarenal aortic aneurysm, techniques and materials continuing improvements allowed endovascular prosthetic substitution of virtually all segments of aorta, including arch, even though sometime with hybrid procedures (Canaud et al, 2010; Antoniou et al, 2010; Tsagakis et al, 2010, Di Eusano, 2011).

It is not the aim of this chapter to describe, even summarily, the historical evolution of these techniques, but rather to try to outline the proved facts of these new therapeutic tools at this point in time.

While obviously technological evolution will further extend indications and improvements in clinical results, superiority of endovascular method vs open surgery at this point in time was conclusively proved in infrarenal aortic aneurysms and in uncomplicated, non genetic, isolated descending aorta aneurysms (Gopaldas et al, 2010). An interesting result of several recent studies (The UK EVAR Trial Investigators, 2010; De Bruin, 2010; Schermerhorn, 2008) showed that, despite a two-thirds decrease in 30-day operative mortality rate after endovascular abdominal aortic aneurism repair (EVAR) compared with open repair, the all-cause mortality curves converge during the first 2-3 years thereafter, with no significant difference in all-cause mortality beyond this time. A recent study (Brown et al, 2011) seems to indicate that more cardiovascular deaths in the EVAR patients group contribute to the convergence in all-cause mortality during the first 2 years.

Quite wide clinical experience however already showed that endovascular procedures cannot protect from spinal chord ischemia and consequent paraplegia in extended descending aorta prosthetic substitution. It has been hypothesized that this could be due, at least in some case, to the fact that while endoprosthesis immediately prevents intercostal branches to be physiologically perfused, cannot prevent, at least for a certain time in the initial phase, backwards blood flow into the space between endoprosthesis and aortic wall, thus generating conditions for a blood flow "steal" from perfusion of the spinal chord (Kawaharada et al, 2010).

Last but not least overall recent USA Nationwide Inpatient Sample data 2006-2007 review (Gopaldas et al, 2010) showed that only 23% (2,563/11,669) of ideal candidate to endovascular treatment (uncomplicated, elective descending aortic aneurysms) underwent endovascular procedure (TEVAR), while the remaining 77% (9,106/11,669) still underwent open surgical repair.

These facts prompted us to consider new strategies against aortic aneurysm based on new tools we developed for its treatment and prevention.

2. New expandable devices for easier, safer and more efficient open surgery for large thoracic or thoracoabdominal aneurysms

Even though endovascular techniques will continuously gain wider indications for prosthetic substitution of the aorta, more complex cases will always remain in which open surgery is the only or the best option. Moreover while acute aortic syndrome is obviously spread throughout the territory only highly specialized centers can offer endovascular techniques as an emergency measure; current data show that vast majority (77%) of uncomplicated, non genetic elective descending aorta aneurysms still underwent standard open surgery in US (Gopaldas et al, 2010). On the other hand open thoracic aorta prosthetic substitution still carries significant risk of serious complications that cannot be prevented even in very highly specialized centers, in particular to CNS and spinal cord.

Although the pathogenesis of these complications is multifactorial, there is general agreement that the length of clamping/circulatory arrest time is an extremely important factor. Since nearly all the clamping/arrest time is spent for vascular anastomosis construction, a device able to quicken and simplify the vascular anastomosis can be expected to have a significant impact on the incidence of these complications.

Suture line haemostasis is another important source of intra- and postoperative complications with standard open technique. In fact due to the altered aortic wall mechanical features, impaired by the underlying aortic pathology (arteriosclerosis, medial cystic degeneration, Marfan disease etc.), the suture line haemostasis may be difficult to achieve in spite of appropriate surgical technique or may require additional surgical maneuvers (buttressing, gluing etc.) that imply prolongation of the ischemia time.

Moreover in cases of dissection, it may be difficult to achieve firm layers approximation and to prevent re-dissection and false lumen persistent perfusion, in particular at suture lines.

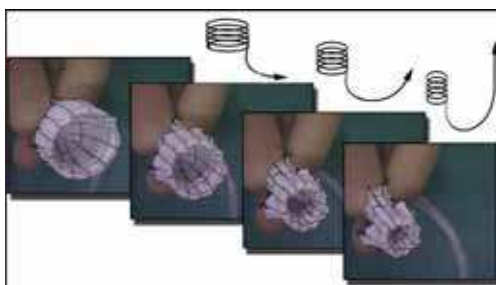

Fig. 9. Expandable device working principle.

Loops of nitinol wire wrapped by Dacron fabric form a rigid sleeve whose diameter can be modified by varying the diameter of the nitinol loops, while the regular cylindrical shape is maintained.

For these reasons several years ago we started research (Nazari et al, 1994) to develop a new expandable device aimed: **1**-to simplify the surgical technique; **2**-to significantly reduce the ischemic time and thus the ischemic complications rate; **3**-to enhance suture line anastomosis; **4**-to achieve firm and reliable dissected layers approximation, thus preventing

re-dissection and/or false lumen persistent perfusion at suture lines, particularly in acute dissection repairs.

The device consists of loops of nitinol wires, wrapped within a Dacron fabric and connected to a prosthesis end (Type I). The nitinol wire loops can be expanded and tightened by activating a removable guide in such a way that device end varies its diameter, while maintaining a regular cylindrical shape. This allows the easy and quick insertion of the retracted device into the vascular stump and then its expansion to perfectly fit with the vessel diameter; haemostasis and permanent device fixation is provided by external ligature/suture.

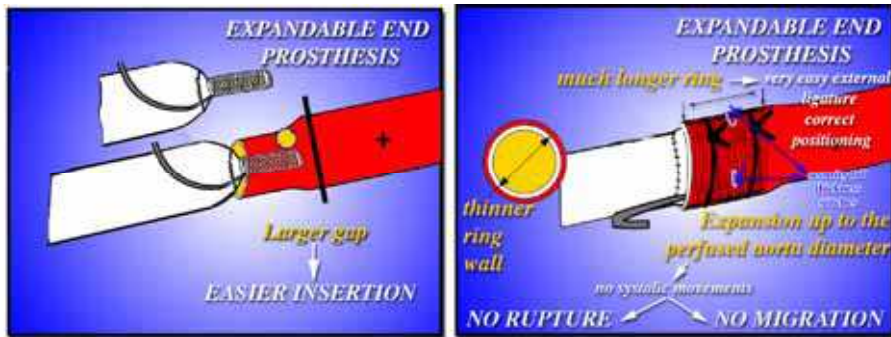

Fig. 10. Expandable device vs intraluminal ringed prosthesis.

The expandable configuration of the ring allows to solve all the insertion, positioning and diameter mismatch problems of the 70ies intraluminal prosthesis.

Its quite evident that the expandable configuration of the ring allows to solve all the insertion, positioning and stability problems of the 70ies intraluminal prosthesis (fig. 10). That makes performing an anastomosis a very simple task, which can be carried out in seconds vs the 10-15 min per anastomosis at best required with standard hand suture.

The aortic wall being not perforated by the suture, the coupling is immediately blood-tight ("air-tight" in fact!) and independent by the integrity of the physiological coagulation mechanisms.

The device underwent many modifications and refinements, finally resulting in three main models (Type I, II and III) applying the same working mechanism, but with different shape to fit with all aorta segments as well as special conditions of use.

Extensive "ex vivo" and "in vivo" animal experiments (Nazari et al 1994, 1996a, 1996d, 1997, 2006, 2009; Rossella et al 2008) were carried out and few clinical cases were also successfully treated with this device (Nazari et al.1999; Aluffi et al, 2002, Buniva et al 2002).

2.1 Device description and operational details

2.1.1 Device type I and II

Device type I and II differ because of the orientation of the activating guide in respect to the main axis of the device wireframe expandable sleeve (fig 11, upper right and lower left squares); that allows the devices to be ideally used for the first and second anastomosis respectively. Thus the type I device, activated by guide-wire coaxial to the lumen, is sutured at one end of the tube graft of appropriate size before clamping, can be quickly and easily positioned either in the proximal or distal end of the aortic tract to be replaced (fig. 11, top

strip). Any further manipulation of the tube graft is then easily possible, including accessory side anastomosis with aortic branches, without any hindrance. The tube graft can then be sectioned at its exact required length and fixed with a single stitch at the rear anastomosis side (fig 11, middle strip); type II device, activated by guide-wire orthogonal to the vascular axis allowing stump connection at both sides, is then inserted, expanded and fixed by external ligature (fig 11, lower strip) ending the ischemia phase.

When the perfusion is resumed, permanent fixation is carried out by tying ligature and applying few full thickness polypropilene 4-0 equidistant stitches, to further stabilize the device thus virtually preventing any possible late dislocation. Activating guide can then be removed by predisposed tools.

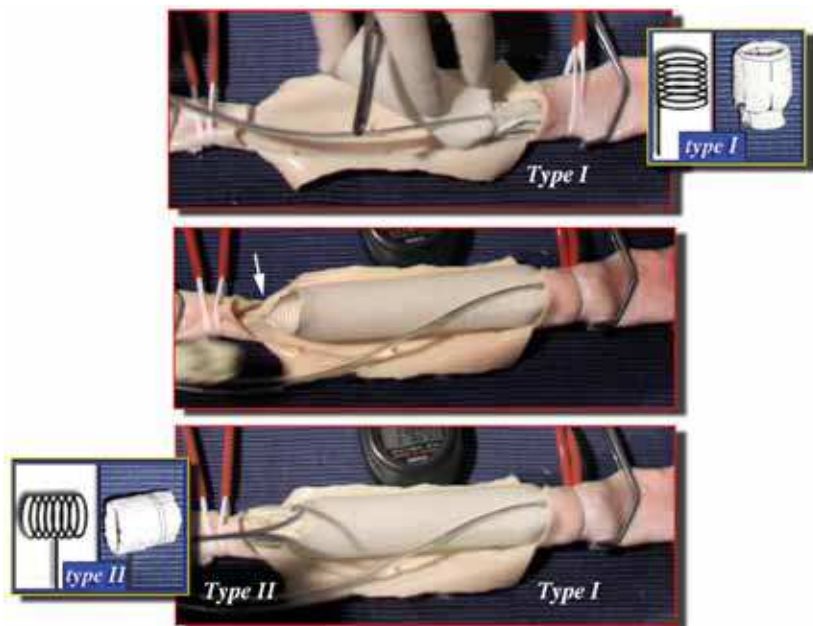

Fig. 11. Device Type I and II.

Device type I, previously sutured to the appropriate diameter tube graft end, is used for the first anastomosis; then after having carried out any other collateral branch anastomosis possibly required, the tube graft is cut at its final measure, fixed with a single stitch at rear anastomosis side (arrow) and device Type II is applied for the anastomosis. Circulation can be immediately resumed after tourniquets tightening. Thus final ligature, full thickness stabilizing stitches (3 at each anastomosis) and activating guide removal can be carried out without prolonging the ischemic phase.

Use of the external ligature (umbilical tape or polypropilene) allows to minimize ischemic time, since the blood flow can be resumed after the simple tourniquet tension, the final stabilization being carried out afterward. With a very little prolongation of ischemia time however a polypropilene suture can be passed in a purse-string fashion also in the vascular intimal surface, totally or partially, with the same functional results (fig. 12). Even in this case it is important to pass the suture full thickness through the device at least in 3 roughly equidistant points in order to prevent any possible late dislocation.



Fig. 12. Purse-string device fixation.

With type I and II devices, the vascular stump encirclement can be avoided and substituted by endovascular (full or partial) purse-string polipropilene suture prepared at the site of expandable device positioning. The required full thickness security stitches can be passed after the circulation has been re-established (from Nazari, 2010).

The solution of positioning and stability problems of the 70ies intraluminal prosthesis (fig. 10) allows for the first time the clinical appreciation of the most important feature of the "Payr principle" of anastomosis (vascular stumps compression against/between rigid structures i.e. an inner rigid ring and external ligature/outer rigid ring) *which is to achieve an immediate hermetic seal* ("air-tight" in fact) ensuring reliable haemostasis at the anastomosis line, not dependent from coagulation. Interestingly enough were just the positioning problems of Payr model as well as of its more recent modification (Intraluminal ringed prosthesis), that prevented in fact the clinical implementation of this coupling method, which is the most intuitive (and in fact was the first to be attempted in vascular surgery) and whose application failed only in the surgical field, while was in use (and still is) in all other technological fields where connectors between elastic/floppy tubing are required.

Of course clinical experience over more than a century has shown that the standard suturing technique does not need to provide an "air-tight" anastomosis to ensure perfect hemostasis in virtually all clinical circumstances. In particular cases however (acute dissection, cystic medial necrosis, etc.), structural impairments of the aortic wall may necessitate additional maneuvers including graft strips buttressing, gluing and a variety of accessory techniques, whose efficacy at achieving hemostasis are not always fully predictable and that obviously further significantly prolong the period of ischemia in this most critical area. A coupling method that provides haemostasis by compression of the stumps' vascular wall between two rigid structures (i.e. inner and outer expandable rigid sleeves) without perforation may be then particularly useful in these cases, not only because of its ease and quickness, but also because it offers the best mechanical chance of immediate blood-tightness. The expected advantages with regards to approximation of dissecting layers and false lumen permanent sealing rely on the same concept.

An other important difference with 70-80ies intraluminal ringed devices is that the expandable sleeve is much more thin and porous, being formed substantially by a double layer of standard vascular dacron fabric, and can, therefore, be wholly and quickly colonized by fibroblasts and integrated with the aortic wall.

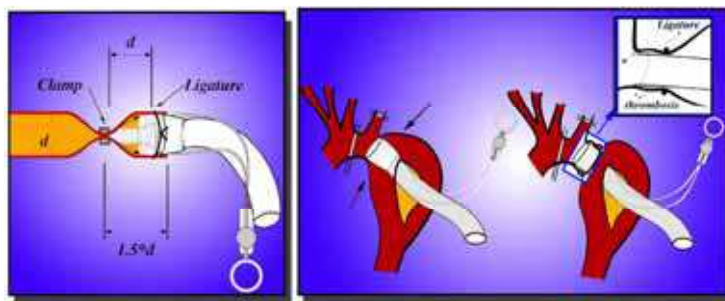

Fig. 13. Expandable device operational details.

Left square. When a clamp is applied the linearization of the stump requires to keep its length significantly longer than usual in order to leave the space necessary for full expansion of the expandable end. It is also important to avoid full longitudinal vascular opening as carried out with current technique and thus keeping intact the entire circumference of the vascular stump for a tract long enough to host the whole device expandable end.

Right square. The expandable end also can be positioned against aneurysmal wall, provided that its distal end would reach the healthy vascular wall. Thrombosis of the tract between the ligature and the prosthesis end will soon move the effective anastomosis line (upper right square*) where it would be with standard suture (mod from Nazari et al, 1997).

The nitinol wire-frame in fact forms a very thin and wide mesh net that accounts for a very small proportion of the device's volume and that offers no significant barrier to fibroblastic invasion of the dacron fabric and thus to stable biological integration of the device. Few technical details must be considered with the expandable devices.

First of all care must be taken when entering the aneurysm not to extend the incision up to both the distal and proximal ends as usually carried out with standard suture; it is in fact very important to keep intact the entire circumference of the vascular stump for a tract long enough to host the device expandable end.

Due to the linearization of the vessel diameter induced by the clamp, the length of the vascular stump distal to it must be significantly longer than imagined before clamping; in practice it is advisable to isolate the vessel for a length exceeding its diameter (Fig. 13, left square).

It may be argued that the use of the device may require a distinct healthy vascular neck, as with endovascular techniques. This is not necessary; the device in fact can be expanded even within the aneurysmal wall and fixed there by the external ligature, provided that its end reaches the healthy vascular wall limit, where ideally the standard suture would be placed (Fig 13, right square). The thrombosis developing in the tract between the ligature and the prosthesis end will soon exclude the brief tract of aneurysmal wall from the bloodstream, thus moving the effective anastomosis line (fig 13,* at upper right square) where it would be with standard suture.

Thus devices type I and II can be ideally used anywhere in descending and abdominal aorta and allow to carry out any required additional surgical maneuver on the tube graft, i.e. collateral branch anastomosis, as well as its appropriate tailoring at the required length measured directly on the operative field as in standard technique without obstacle or hampering condition. Its great simplicity of use allows the devices to be used also in condition of suboptimal operative field exposure. Thus for example both proximal and distal

anastomosis in extended descending thoracic aorta substitution be easily and safely carried out though a single space thoracotomy; moreover aortic prosthetic substitution via mini-access thoracotomy or laparotomy video-assisted setting may be also predictably considered.

2.1.2 Device type III

In this version of the device the external ligature is substituted by an expandable sleeve, which is based essentially on the same working principle as the inner sleeve, but activated contrariwise. Thus, the vascular stump is compressed between two sleeves (Fig. 14, upper left little squares), with variable and controllable diameters, allowing full control of the pressure (amount and surface of its application) applied to the vascular stump.

Operative technique for device type III is illustrated in fig 14 in ascending aorta "ex vivo" model and it is really very simple. First of all both sleeves diameter is set at the predicted value of the aortic tract where the device will be applied. Then the inner sleeve diameter only is reduced as much as possible by acting on its guide-wire; this causes also the backwards eversion and partial rotation of the outer sleeve thus greatly enhancing inner sleeve visibility and then its easy positioning into the vascular stump. The inner sleeve is then re-expanded against the vascular stump inner surface; at this point the outer sleeve is gently retracted acting on its own activating guide to compress the vascular stump.

The primary aim of this new version of the device is to make possible and convenient to apply this coupling principle also to acute ascending aorta and arch dissection, in order to simplify the technique, to reduce the ischemic time, to improve hemostasis of the anastomosis line and to achieve reliable, stable sealing of the dissection layers in this very complex surgical setting. The device in fact allows to actually automate substantially the same aortic wall sandwiching between two graft strips procedure usually carried out in the dissection cases and realizing at once the prosthesis anastomosis, being the tube graft (not shown in the figure) obviously previously sutured to the inner sleeve proximal end. Interestingly enough the particular configuration of the device allows full and easy compliance with aortic anatomy, perfectly adapting also to the elliptic, asymmetric "oblique" stump resulting from inclusion of the arch concavity in the anastomosis line (Fig. 15, B). Full and persistent air-tight sealing of the device-aortic wall coupling was verified at endovascular pressures of up to 150 mmHg in "ex vivo" swine aortic models, including those involving an elliptic, 'oblique' anastomosis (Fig. 15, b) (Nazari, 2010). As expected, standard vascular sutures were not air-tight even at pressures below 10 mmHg (Fig. 15, c).

Type III device use is then ideally indicated in dissection cases for distal anastomosis sited at distal ascending aorta, including as much as required of the concavity of the arch during a very brief circulatory arrest phase; proximal anastomosis will be then carried out either by hand suture or with the expandable device version most appropriated for the particular anatomical condition, in normal CEC in no rush and after having performed any additional procedure possibly required, for example on the valve.

Anastomosis at the distal arch/proximal descending aorta in case of full arch substitution is also an ideal indication for type III device use in case of dissection or whenever, for particular aortic wall fragility, graft strips sandwiching buttressing may be advisable. Supra-aortic trunks in these cases can be ideally re-vascularized by devices type I previously appropriately connected to the main tube graft so that they can be plugged in and there fixed by purse-string partially or entirely passed from inside the vascular lumen (fig. 11).

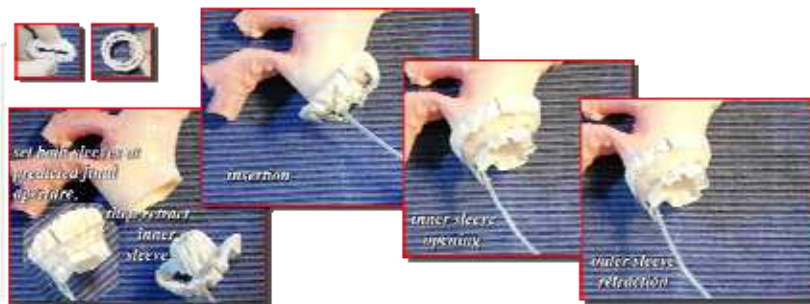

Fig. 14. Device type III.

The type III device incorporates an external sleeve that substitutes the external ligature, thus allowing standardization of the pressure applied to the vascular stump wall. The wire-frame of the device is quite soft and compliant, and can be easily compressed and widely deformed while maintaining perfect reciprocal alignment of the internal and external sleeves (top left squares). Lower squares: First of all both sleeves are set at predicted final aperture. Acting only on the activating guide of the inner sleeve results in outer sleeve backwards rotation and eversion, bringing the retracted inner sleeve in full visibility, so that can be easily inserted into the vascular stump. Then inner ring is expanded as much as the vascular wall can be distended by acting contrariwise on the same guide. At this point, the outer sleeve is only slightly retracted towards the aortic wall using its own guide. (Nazari, 2010) Video at <http://www.fondazione-carrel.org/tsb2/tsb2.html>



Fig. 15. Device type III seal test.

The outer surface of the inner sleeve was wrapped by a latex cuff (top squares) in order to overcome the problem of the porosity of the dacron graft and the requirement for the connection of the tube graft to the proximal end of the inner sleeve as in its final clinical use. A) The air-tightness of the connection was verified at endovascular pressures of up to 150 mmHg in a regular cylindrical anastomosis of ascending aorta (white bars). (B) The same was verified when the anastomosis is irregularly oriented, such as when involves the arch concavity. (C) As easily predictable, a standard suture (4-0 prolene) of an approximately 3 cm incision of the aortic wall cannot be proved airtight even at minor endovascular pressure. (Nazari, 2010). Video at <http://www.fondazione-carrel.org/tsb2/tsb2.html>

Thus in all cases where sandwiching buttressing is planned the use of the device type III requires exactly the same aortic stump external wall preparation required for hand suture double graft strips application. When anatomical conditions do not require sandwiching buttressing, device type I or type II may be also used even without external vascular stump encircling, being possible to fix the expanded device end by purse-string passed entirely or partially from inside the aortic lumen (fig. 11).

The great simplification and the very significant quickening of this complex surgical part together with the higher accuracy and “mechanical” reliability of this coupling method in comparison with manual suture could potentially have impact that may exceed that strictly related to the anastomosis. For example being possible to carry out even the entire arch revascularization in few minutes of circulatory arrest, the level of hypothermia may be very significantly reduced and even the type of cerebral protection may be tailored to these very restricted time lapses, just to say the firsts coming in mind.

2.1.3 Other expandable device models

We also realized a variety of modified versions of the device to better fit with the anatomical configurations occurring in particular clinical circumstances.

2.1.3.1 Type I – SOLD (Single Outer Layer for small Diameters)

In small vessel diameters obviously device dimensions can interfere more significantly with physiological lumen amplitude in their range of use. More in particular the unpredictable way of folding of the inner fabric layer when the device is incompletely opened may significantly reduce the lumen available for the blood flow. Accordingly for diameters ≤ 12 and ≥ 6 mm we decided to use devices wrapped by fabric only at external layer (fig. 16). Two sizes were prepared respectively for diameter from 6 to 9 (SS) and from 10 to 12 mm (S). This may fit for renal artery, celiac axis and supraortic trunks. The device is previously prepared at the end of collateral branch of the main tube graft tailored at the expected appropriated length or directly on the main tube graft. The particular fabric disposition implies a mandatory blood flow direction, which however allows the use as main tube graft lateral branches for the major aortic branches.



Fig. 16. Device type I – SOLD.

For small diameters vessels (≥ 6 mm ≤ 12 mm) device type I was prepared with single outer fabric graft in order to prevent the possible significant interference with vascular lumen of unpredictable way of folding of the inner layer when the device cannot be fully expanded. These devices allow one way flow direction only.

Video at <http://www.fondazione-carrel.org/tsb2/tsb2.html>

2.1.3.2 Type II – BIO (Bending and Independent Opening)

This type II device modified version is intended for use in ascending aorta substitution in absence of dissection. The two ends of the device can vary their reciprocal axis up to 90° to

better fit with the curvature of the ascending aorta; their aperture can be independently controlled in order to comply with possible differences in diameter of the proximal and distal stumps. In this way the ascending aorta substitution can be carried out very quickly by one single device.

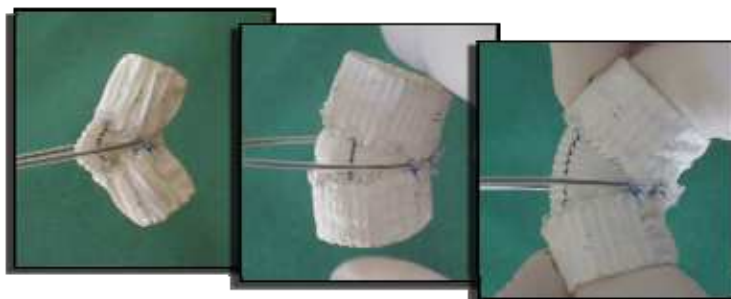

Fig. 17. Device Type II - BIO.

This type II device version allows the bending up to a 90° degree angle of the axis of their ends, whose aperture can be independently controlled. This allows to fit curved anatomy of ascending aorta and possible variations in diameter of the vascular stumps.

Video at: <http://www.fondazionecarrel.org/tsb2/tsb2.html>

In case of dissection however type III device previously connected with graft tube should be better used for distal anastomosis. Proximal anastomosis can be carried out with standard suture, time being not here a critical factor, or by a second type III device if dissection involves also the proximal anastomosis line.

This device version can also be used in isthmus rupture repair, having care of entering the aorta through or close to the laceration in order to preserve integrity of the vascular wall at site of device ends deployment.

2.1.3.3 Recent refinements

The extensive past experience provided full mechanical reliability of devices in all their versions and proved their easy applicability to aortic stump in all conditions. While the expandable device allows a much easier, quicker and more efficient (“airtight” seal) graft-aortic stump coupling than standard suture (Nazari 2010), it implies however the permanence of endovascular tubular wireframe and external ligature that could, at least theoretically, mechanically conflict with aortic wall, particularly at device ends, and with confining tissues/organs.

Aorto-digestive fistula is an infrequent but well documented occurrence after aortic open (Geraci et al 2008; Luo et al, 2010) as well as after endovascular (Ruby & Cogbill, 2007; Marone et al, 2007; Chiesa et al, 2010) repair. While graft or/and suture line contamination/infection may occasionally be suspected as the primary etiological factor, pure mechanical erosion from systolic movements of graft and even from the suture line only (Tanaka et al, 2009) may probably represent the first triggering factor in a portion of cases difficult to quantify.

The pure mechanical effect of these movements on the confining tissue/organ is predictably higher the harder/less compliant is the prosthetic material as well as the more conflicting is its orientation in relation to the confining tissue/organ.

We then recently focused on optimal consistency of the expandable wireframe and on means to provide external fixation with the final aim of achieving mechanical forces of coupling as much as possible similar to those taking place in standard hand suture anastomosis.

For this purpose, on one side, the wireframe consistency was decreased by variably reducing the gauge of nitinol wires and their respective position within wireframe and, on the other side, the external ligature was carried out with the thinnest possible prolene (5-0) encircling suture, transfixing full thickness the device and aortic wall at three equidistant points. The limit of the former was the ability to sustain the external ligature without wireframe deformation/collapse at pressure providing "airtight" seal; the limit of the later was the ability to provide stability of the aortic stump-expandable device coupling at stretch test.

The present versions of the devices with minimal consistence and great compliance minimize the risk of mechanical conflict and erosion with the confining tissue/organs; moreover wireframe consistency was settled in such a way that is minimal at the device end where the possible conflict with aortic wall could be higher.

Concerning the external ligature and its many possible ways of application, it may be useful to recall that vascular anastomosis must guarantee haemostatic sealing and stability of the coupling which, contrariwise to standard suture, rely on different mechanisms with this type of coupling (Fig. 8).

Thus even though external devices surface is provided with short needles perpendicularly positioned around its circumference at 4-6 equidistant points, reduction of the wireframe consistency may probably decrease their reliability in keeping coupling stability.

To optimize coupling stability in this lighter expandable wireframe we successfully tested 5-0 prolene encircling suture, transfixing full thickness the device and aortic wall at three equidistant points (fig. 18). In this way in fact the minimal expandable wireframe consistence to sustain the external ligature can be further significantly reduced and stability increased, by splitting the external ligature circumference in three separate and equivalent segments. In this embodiment the expandable ring will be then really only a bit more consistent of a common graft tube.

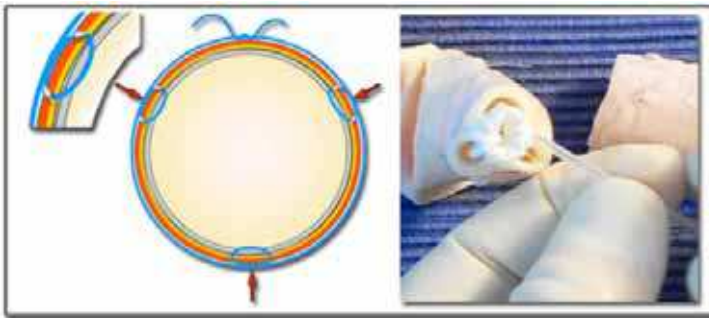

Fig. 18. Carrel's triangulation - back to the future.

To provide reliable coupling stability, instead of simple external ligature, 5-0 prolene encircling suture, transfixing full thickness the device and aortic wall at three equidistant points, was passed and tied as shown, in a sort of revival of the Carrel triangulation historical technique. Video at <http://www.fondazionecarrel.org/tsb2/tsb2.html>

This coupling stability was proved by a stretch test consisting in a sequence of manoeuvres carried out on the anastomosis that includes: **1)** complete compression of the anastomosis in orthogonal directions and then **2)** vigorous manual stretching of the anastomosis in the coaxial plane separately at four points of its circumference. The sequence was repeated three times and the anastomosis checked for any significant vascular stump backwards dislocation on the expandable wireframe throughout the entire circumference.



Fig. 19. Stretch test.

Stability coupling was validated by stretching test consisting in vigorous manual stretching of the anastomosis in the coaxial plane separately at four points of its circumference; the anastomosis was then checked for any significant vascular stump backwards dislocation on the expandable wireframe throughout the entire circumference.

Video at: <http://www.fondazione-carrel.org/tsb2/tsb2.html>

Device type III stability was also increased by further buttressing the inner and outer Dacron wrapping by 4-0 prolene suture transfixing the circumference in 3-6 points (fig. 20), a manoeuvre that however can be predictably carried out after perfusion is resumed.

While it's certainly easier and also a bit quicker to use expandable device wireframe strong enough to block the aortic stump between simple external ligature and outer surface of the device fixing needles, I think that it's much more technically appropriate and probably safer to realize a vascular/graft coupling where the forces applied are as much as possible similar to those involved in standard vascular suture, even though this can mean a minimal increase of ischemic time, required for placing the 3 full thickness stitches around the positioned device.

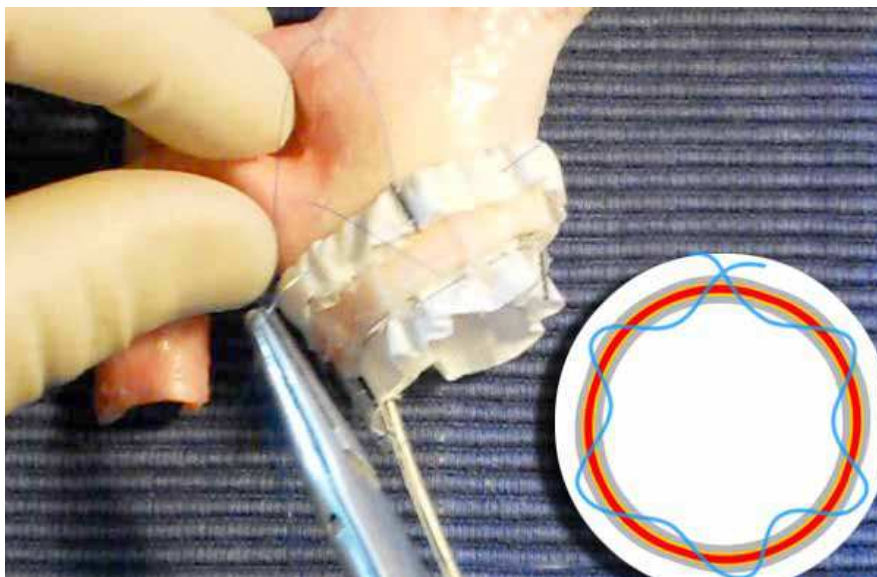

Fig. 20. Type III security fixation.

A simpler in and out 4-0 prolene buttressing in 4-6 points of the inner and outer device wireframe will greatly increase coupling stability.

Video at: <http://www.fondazione-carrel.org/tsb2/tsb2.html>

In synthesis this method ideally allows to change any vascular-graft anastomosis ≥ 6 mm in diameter from the current facing ends Carrel suture into a simpler, quicker and more efficient (“airtight” seal) telescoping anastomosis, sealed and fixed by single thread external ligature passed full thickness at three points (or more when appropriate), in a sort of ideal re-elaboration of the historical Carrel triangulation technique.

The hypothesizable potential impact (table 1) may exceed that expected on complication rate of open prosthetic substitution of all aortic tracts and in particular in those higher risk conditions as acute dissection. In fact the technical simplification with increased reliability of anastomosis haemostasis and dissection layer approximation with false lumen permanent seal has the logical direct consequence, for example, of enabling also lesser expert cardiovascular surgeons to deal with these clinical cases very often requiring immediate surgical attention, thus increasing surgical team efficiency and hospital unit productivity.

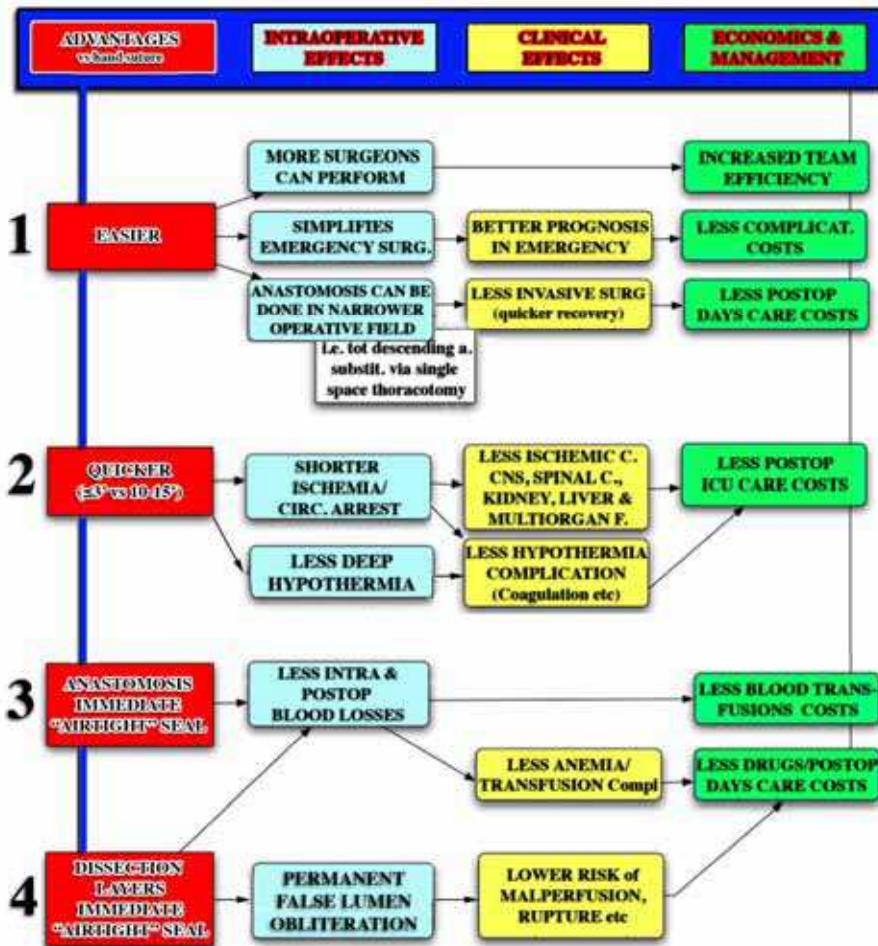

Table 1. Potential impact of expandable device aortic anastomosis compared with current hand suture technique

3. New endovascular “net” prosthesis for aortic wall strengthening without blocking aortic branches perfusion to early stop aneurysm progression or to prevent its formation in high risk patients

3.1 Background

While endovascular procedures already proved lower mortality and complications rate than open surgery and as good long term results in infrarenal and upper descending aorta, in all other aortic tracts endovascular techniques are much more complex and long term results less predictable mainly due to the presence of significant collateral branches, that require additional maneuvers to avoid their obstruction by the endoprosthesis (i.e. hybrid procedure with open surgery for supraortic trunks de-branching).

Moreover endovascular procedures failed to protect from spinal chord ischemia and consequent paraplegia in extended descending aorta prosthetic substitution; it has been hypothesized that this could be due, at least in some case, to the fact that while endoprosthesis prevents intercostal branches to be physiologically perfused, cannot prevent, at least for a certain time in the initial phase, backwards blood flow into the space between endoprosthesis and aortic wall, thus generating conditions for a blood flow “steal” from perfusion of the spinal chord (Kawaharada et al, 2010).

On the other hand current data (Gopaldas et al, 2010) show that only less than 1/4 of ideal candidates to endovascular treatment (uncomplicated, non genetic, isolated, elective descending aortic aneurysms) underwent endovascular procedure, while the remaining 3/4 still underwent open surgical repair in US.

3.2 The rational

The relative slowness of aneurysm formation and progression to rupture indicates that the decrease in the strength of the arterial wall under the aneurysm formation threshold may be very gradual and limited. Consequently one can imagine that measures to increase, even moderately, the mechanical strength of the arterial wall, for example by means of a dacron fabric network, should be successful in preventing aneurysm formations and thus its complications (dissection and rupture), without requiring complete prosthetic substitution. Moreover the conclusive understanding that a destruction of the elastin fibrils network is at the basis of aneurysm formation [Gott et al, 1996], might acknowledge the re-establishment of a uniform and regular network strengthening of the vascular wall with a net prosthesis as a logic, direct correction of the primary defect. On the other hand this mechanical approach since long time is already in use in many other technology fields for prevention of deformation of elastic/floppy tubes or structures subject to inner high pressure, as for example gardening tubes, tires, rubber boat etc.

In previous animal experiments we showed that the endovascular positioning of polypropilen “net” prosthesis, if kept in contact with the inner vascular surface, is spontaneously covered by new intima and included in the aortic wall in few weeks (fig 21 and fig 22), still keeping perfusion of some intercostals vessels, even though the net meshes used in those experiments were certainly too tight to assure their long term patency.

The experimental hypothesis is based on the fact that the net prosthesis positioned and maintained in stable contact with the aortic walls (A) is spontaneously, gradually covered by the neo-intima (B), invaded by fibroblasts and thus stably associated to the aortic wall. If the net mesh is appropriately dimensioned, it may be expected that the blood flow through the collateral branches is not affected (arrows) (from Nazari et al, 1996c)



Fig. 21. The Rational. The experimental hypothesis is based on the fact that the net prosthesis positioned and maintained in stable contact with the aortic walls (A) is spontaneously, gradually covered by the neo-intima (B), invaded by fibroblasts and thus stably associated to the aortic wall. If the net mesh is appropriately dimensioned, it may be expected that the blood flow through the collateral branches is not affected (arrows) (from Nazari et al, 1996c)

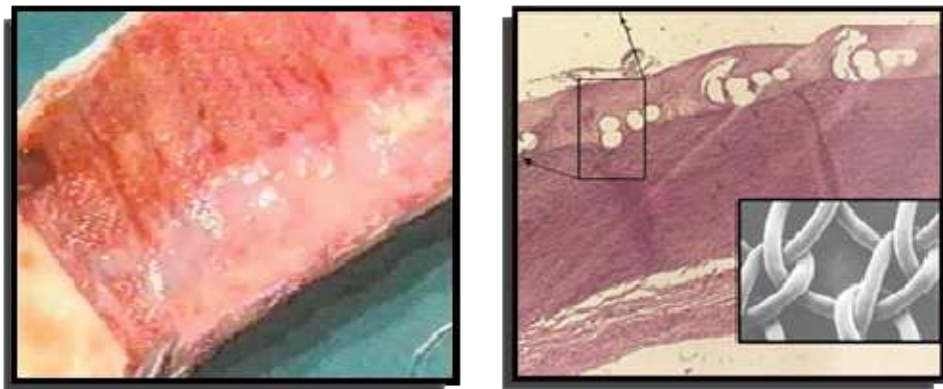

Fig. 22. Swine experimental model.

Left square. After 6 weeks the net prosthesis, a braided polypropylene fitted with a co-axial thin stainless steel coil surgically positioned in swine upper descending aorta, was found to be covered by the new intima and well attached to the aortic wall. In the lower right side of the prosthesis segment the net is no longer visible and presumably, with little more time, this smooth, normal intimal surface would extend to completely cover the whole net prosthesis (metallic coil was removed). *Right square.* Histology shows the net prosthesis completely included into the intima layer and lying in contact with the media. The square area shows the magnified polypropylene mesh net pattern. (mod from Nazari et al 1996 c) Video <http://www.fondazione-carrel.org/tsb2/tsb2.html>

The fabric framework linked to the aortic wall would then condition its significant, regular and uniform mechanical strengthening that fractionates and absorbs the centrifuge systolic stress of the bloodstream. The significant mechanical strengthening achieved in this way was measurable by comparison of compliance ($\Delta V/\Delta P$) of the treated aortic tract with that of the immediately confining segment (fig 23)

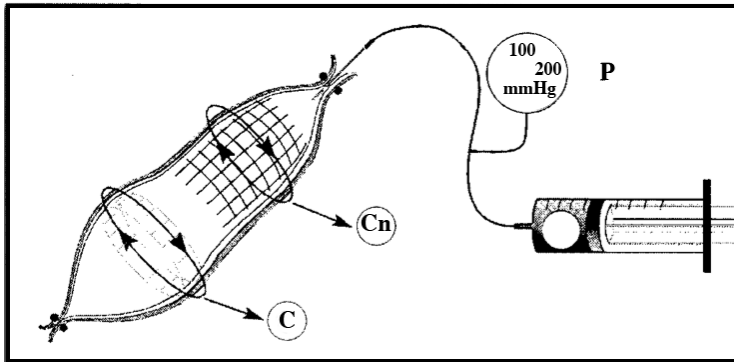

Fig. 23. Aortic wall compliance ($\Delta V/\Delta P$).

To quantify aortic wall strengthening induced by the net prosthesis its compliance ($\Delta V/\Delta P$) was compared with that of the confining segments that was found significantly higher. (from Nazari et al 1996b) Video at <http://www.fondazione-carrel.org/tsb2/tsb2.html>

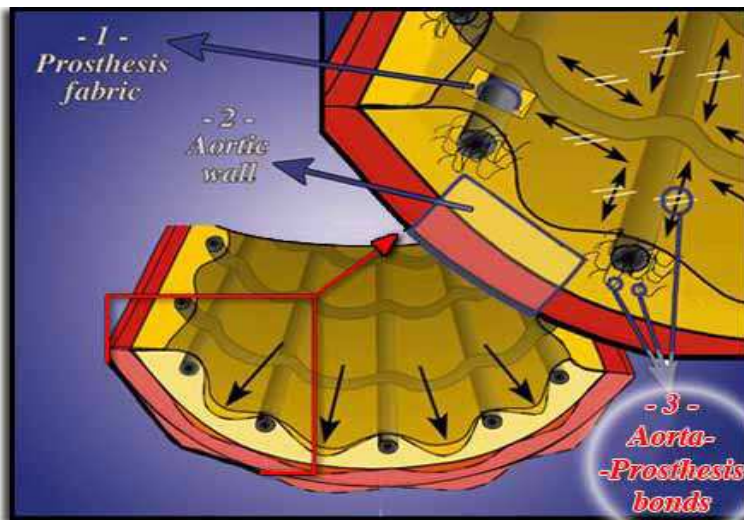

Fig. 24. Aortic wall strengthening factors.

The structural properties of the aortic wall associated to the intraluminal net prosthesis rely on three factors: **1)** the structural properties of the net prosthesis, **2)** the structural properties of the aortic wall, **3)** the strength of the bonds between the aortic wall and the net prosthesis, based substantially on fibroblastic invasion of the net fabric and its permanent integration with aortic wall. The latter is the crucial point and can be viewed as the true "functional unit" of this model. In fact if this link is sufficiently strong and stable in the time it can be hypothesized to be able to stabilize aortic wall and prevent dilatation even independently from the "net" prosthesis own diameter, which could not be further distended after that their fabric threads have been integrated into the aortic wall. (mod. from Nazari et al 1996b)

The structural properties of the aortic wall associated to the intraluminal net prosthesis rely on three factors (fig 24): 1) the structural properties of the net prosthesis, 2) the structural properties of the aortic wall, 3) the strength of the bonds between the aortic wall and the net prosthesis, based substantially on fibroblastic invasion of the net fabric and its permanent integration with aortic wall. Given the structural adequacy of the net prosthesis (polypropylene net prosthesis squared mesh 5x5 mm with a thread diameter of 0.5 mm sustaining a pressure of 300 mmHg (0.04 Nmm²) is charged at 50% of its failure tension (Nazari et al, 1996b, 1996c) and the mechanical effect of fractioning the aortic wall in the small area of the net meshes (fig 24, lower part), the important point of this model is the strength of the links biologically established between the threads of the mesh and the aortic wall tissues (point 3 in fig. 24) during the 4-6 weeks integration process.

It may be hypothesized that its strength relies mainly in the degree of integration of the net thread with the intimal layer mainly due to fibroblastic invasion and is then predictably stronger with porous material (PTFE) or multifilament braided polyester (Dacron).

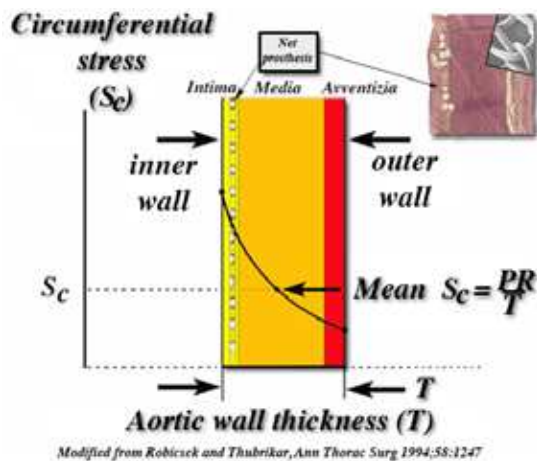

Fig. 25. Variation of the circumferential stress through the aortic wall thickness.

For a thick cylinder (thickness > 8% of the radius (R)) such as the aorta, the stress is not uniform throughout the wall; it is maximal on the inner wall, it decreases through the thickness of the wall and is minimal on the outer wall. This explains the pathogenic mechanism of dissection, where only stress to the inner part of the wall is strong enough to cause tear; moreover it adds arguments to the rationale of intraluminal positioning of the net prosthesis in order to achieve the structural strengthening just where this is most needed, i.e. where the circumferential stress is maximal. This allows for the required strengthening with optimization of the amount of prosthetic material (thinner threads) (Mod from Robicsek and Thubrikar 1994)

The latter is the crucial point of this model. In fact if this link is sufficiently strong and stable in the time, it can be hypothesized to be able to stabilize aortic wall and prevent dilatation even independently from the "net" prosthesis own diameter, which could not be further distended after that their meshes have been firmly integrated into the aortic wall (Redaelli & Fiore, 2011). The practical consequence is that the precise equivalence between diameter of the net prosthesis and aortic diameter is not necessary; the prosthesis in fact can be

significantly redundant in respect to the effective aortic diameter, thus allowing for its easier adaptability to geometrical irregularity of aneurysm wall without consequences on its efficiency in keeping stable aortic diameter. The final "functional unit" of this model for aortic wall strengthening is then the single mesh of the net integrated into the aortic wall, whose efficiency relies then on the bonds between net threads and aortic tissue.

Interestingly enough in this model the endovascular net prosthesis provides aortic wall mechanical support just where the mechanical stress is higher (Robicsek & Thubrikar, 1994) (fig. 25), and thus just where it's most needed both to prevent further dilatation, theoretically preventable also by external aortic wall wrapping (Pepper et al 2010), and to avoid partial (dissection) or total rupture, with optimization of the amount of prosthetic material. The reduced volume of the net prosthesis in comparison with current endoprosthesis ($\leq 1/6^{\text{th}}$ approximately) further greatly enhances its introduction through peripheral vessel often tortuous and restricted by atherosclerosis.

3.3 Methodology

The previous experimental work as well as structural mechanical theoretical considerations allow to predict applicability and reliability of the method in the clinical setting of preventing aneurysm formation or arresting its progression at an early stage.

The organizational plan for achieving this final goal however includes several further distinct steps.

3.3.1 Ideal "net" prosthesis prototypes setup

This part of the project includes

- the selection of the best fabric material (PTFE, multifilament polypropylene, etc) with the best chances of the strongest links with aortic wall
- identification of its appropriated dimensioning and mechanical features, including elasticity, to provide the best support to the stream pressure stress up to its extreme pathological limit (300 mm hg)
- identification of the most appropriate net prosthesis embodiment able to maintain it in permanent contact with intimal surface, which is essential to its quick and spontaneous incorporation into the aortic wall. This may include a thin nitinol wireframe associated to the main net prosthesis; a prototype for descending aorta currently in study is illustrated at fig. 26. However fluid-dynamic shapes of the net threads will be also evaluated in mechanical models with the aim to verify if it is possible to achieve conduit inner wall contact by means of pure fluid stream
- Ascending aorta and Arch require variably curved net prosthesis (fig 26, right); for these tracts however bespoke prosthesis on the individual TC scan, maybe with wider meshes for the supraortic trunks area, is an option to be considered for clinical use; bespoke prosthesis however have being already realized in a external ascending aorta wrapping protocol (Pepper et al, 2010)).
- Endovascular delivery system is also to be realized

The nitinol wireframe adds to the net further structural strengthening then greatly exceeding that required; an accurate structural mechanics computation would theoretically allow the achievement of the necessary aortic wall structural strengthening to permanently fix aortic diameter with really a very thin and wide meshes net prosthesis.

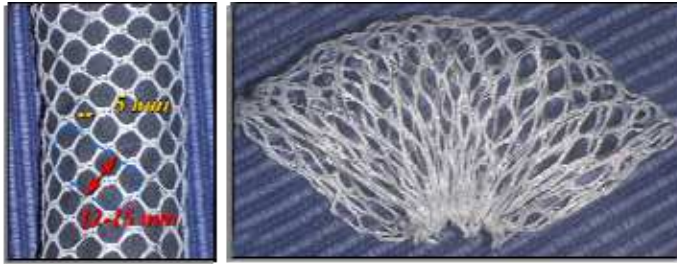

Fig. 26. "Net" prosthesis prototypes.

Possible prototypes versions were realized by 5x5mm meshes of braided fabric embodied with very thin nitinol wider helicoidal wireframe (*left*: blu lines, red arrows, 12-15 mm). Ascending aorta and arch would require curved prosthesis (*right*), maybe bespoke to the patient aortic anatomy on CT scans.

A more straight, ready, maybe oversimplified method, but still mechanically efficient, could consist in the simple substitution of the Dacron tube with a fabric net prosthesis in any of the current endovascular devices.

3.3.2 Experimental protocol

The prototypes resulting from the above project phase will undergo "in vivo" animal experiments. Ideally these experiments should include long term (≥ 12 months) evaluation in an appropriate animal (sheep) models. These may consist in prototypes positioning in the thoraco-abdominal aorta (model 1) and in the aortic arch (model 2) surgically or, possibly, as endovascular procedure if the endovascular delivery system is realized and suitable with the animal model peripheral vascular diameter. Half surviving animals could be sacrificed at 12 months and examined to verify:

- regular integration of the net prosthesis into the intimal layer, looking for site and extension of possible areas on lacking integration with aortic wall
- preserved perfusion of all collateral branches for the extent of the net prosthesis
- the real structural strengthening achieved by measuring the aortic wall compliance ($\Delta V/\Delta P$) compared to that of the confining aortic segment (Fig. 5)
- absence of complications such as migration, ulceration, perforation etc

The remaining animals could be followed indefinitely and examined in case late complication or death.

3.3.3 Preparation of clinical trial

Ideally during the experimental phase will be identified and monitored Marfan patients with still normal or initial dilatation of any tract of the aorta in order to select those to be offered/accepting the prophylactic endovascular aortic strengthening. Obviously associated risk factors, in particular familiar history of aneurism and rupture, as well as other inclusion and exclusion criteria indicated by the Marfan Associations and clinical Institution Marfan Centers, will form the basis for planning the possible future clinical trial.

Marfan diseases is a condition where pure prophylaxis of aortic aneurism would be in most cases "per se" appropriate, due to its very high incidence and rather early in the patient life; on the other hand prophylactic surgical aortic substitution is an already considered option

in occasional patients. Prophylaxis is then particularly suitable for these patients with this new method when its long term safety, efficacy, simplicity and predictably low cost are proved; the re-establishment of an artificial elastic network in fact will represent a logic, direct correction of the primary defect, i.e. fragmentation and destruction of vascular wall physiological elastin fibrils network (Gott et al 1996).

This will otherwise open interesting new perspectives in the “very early treatment” of any type of aortic aneurisms as soon as they appear, well in advance the current endovascular or surgical treatments are indicated, when the still limited aortic geometry distortion both simplifies net prosthesis positioning and integration into the aortic wall and increase its efficiency.

The final goal is then the mininvasive, low cost, full prevention of the costly and still risky endovascular or surgical treatments of overt aortic aneurysm of any nature, ideally in all aortic tracts.

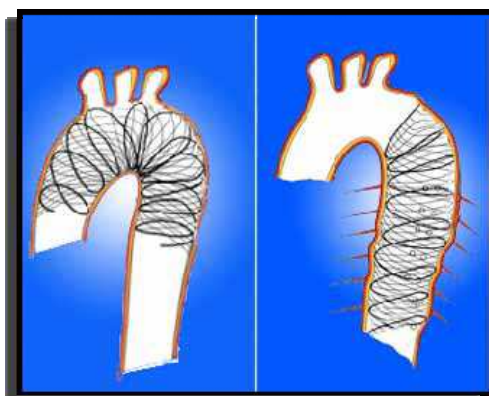

Fig. 27. Prophylactic or very early strengthening of Aortic Arch and Descending Aorta. Sketches illustrate an hypothetical application of the method in high risk aortic area as a pure prophylactic measure for example in Marfan patient. In extended descending aorta this method is the only one that may theoretically provide full prevention of spinal chord complications, not yet fully achieved neither by surgery nor by endovascular techniques. (From Nazari et al 1996b)

Last but not least this method could be the only one theoretically able to totally annul complications related to spinal chord ischemia due to critical intercostal collaterals, still a major problem not yet solved by any surgical nor endovascular technique.

4. References

- Aluffi A, Buniva P, Rescigno G & Nazari S. (2002) Improved device for sutureless aortic anastomosis applied in a case of cancer. *Tex Heart Inst J.* 29: 56–59.
- Antoniou GA, El Sakka K, Hamady M & Wolfe JH. (2010) Hybrid treatment of complex aortic arch disease with supraaortic debranching and endovascular stent graft repair. *Eur J Vasc Endovasc Surg.* 39:683-90.
- Berger RL, Romero L, Chaudhry AG & Dobnik DB.(1983) Graft replacement of the thoracic aorta with a sutureless technique. *Ann Thorac Surg.* 35:231–239.

- Brown LC, Thompson SG, Greenhalgh RM & Powell JT (2011): Incidence of cardiovascular events and death after open or endovascular repair of abdominal aortic aneurysm in the randomized EVAR trial 1. *British Journal of Surgery* 98: 935-942
- Buniva P, Rescigno G, Salvi S, Aluffi A, Berti A, Salsi F, Nazari S (2002) Sutureless expandable end prosthesis for descending aorta substitution invaded by bronchogenic cancer. Video, Proceedings Aortic Surgery Symposium VIII, New York, May 2-3, 2002
- Canaud L, Hireche K, Berthet JP et al.(2010): Endovascular repair of aortic arch lesions in high-risk patients or after previous aortic surgery: midterm results. *J Thorac Cardiovasc Surg.* 140:52-8.
- Carrel A. (1902) La technique opératoire des anastomoses vasculaires et la transplantation des viscères. *Lyon Med.* 98:859-864.
- Carrel A. (1907) The surgery of blood vessels. *Bull Johns Hopkins Hosp*;18: 18-27.
- Charnsangavej C, Wallace S, Wright KC, Carrasco CH & Gianturco C. (1985) Endovascular stent for use in aortic dissection: an in vitro experiment. *Radiology.*157:323-4.
- Chiesa R, Melissano G, Marone EM, Marrocco-Trischitta MM & Kahlberg A (2010) Aorto-oesophageal and aortobronchial fistulae following thoracic endovascular aortic repair: a national survey. *Eur J Vasc Endovasc Surg.* 39:273-9.
- Crawford ES & Crawford JL, editors (1984). *Diseases of the aorta.* Baltimore: Williams and Wilkins, 61-77.
- De Bruin JL, Baas AF, Buth J, Prinssen M, Verhoeven EL, Cuypers PW et al.; DREAM Study Group.(2010) Long-term outcome of open or endovascular repair of abdominal aortic aneurysm. *N Engl J Med* 362:1881-1889.
- Di Eusanio M, Armario A, Di Marco L, Pacini D, Savini C, Martin Suarez S, Pilato E & Di Bartolomeo R (2011) Short- and midterm results after hybrid treatment of chronic aortic dissection with the frozen elephant trunk technique. *Eur J Cardiothorac Surg* 2011 Mar 5. (Epub ahead of print)
- Geraci G, Pisello F, Li Volsi F, Facella T, Platia L, Modica G & Sciume C (2008) Secondary aortoduodenal fistula. *World J Gastroenterol.* 14:484-6.
- Gopaldas RR., Huh J, Dao TK, LeMaire SA, Chu D, Bakaeen FG & Coselli JS (2010) Superior nationwide outcomes of endovascular versus open repair for isolated descending thoracic aortic aneurysm in 11,669 patients. *J Thorac Cardiovasc Surg.* 140:1001-10
- Gott VL, Laschinger JC, Cameron DE, Dietz HC, Greene PS, Gillinov AM, Pyeritz RE, Alejo DE, Fleischer KJ, Anhalt GJ, Stone CD & McKusick VA:(1996) The Marfan syndrome and the cardiovascular surgeon. *Eur J Cardiothorac Surg.* 10:149-158
- Kawaharada N, Ito T, Koyanagi T, Harada R, et al (2010) Spinal cord protection with selective spinal perfusion during descending thoracic and thoracoabdominal aortic surgery. *Interact CardioVasc Thorac Surg.* 10:986-991
- Kolesov VI, Kolesov EV, Gurevich IY & Leosko VA.(1970) Vasosuturing apparatuses in surgery of coronary arteries. *Med Tekhnika* 6:24-8
- Kolesov VI & Kolesov EV. (1991) Twenty years' results with internal thoracic artery-coronary artery anastomosis [letter]. *J Thorac Cardiovasc Surg.* 101:360-1
- Konstantinov I E. (2004): Vasilii I. Kolesov A Surgeon to Remember. *Tex Heart Inst J.* 31: 349-358.

- Lemole GM, Strong MD, Spagna PM & Karilomicz MD(1982). Improved results for dissecting aneurysms: intraluminal sutureless prosthesis. *J Thorac Cardiovasc Surg.* 83:249-255.
- Luo CY, Lai CH, Wen JS & Lin BW (2010) Secondary aortocolic fistula: case report and review of the literature. *Ann Vasc Surg.*24:256.e5-12.
- Marone EM, Esposito G, Kahlberg A, Tshomba Y, Brioschi C, Zannini P & Chiesa R. (2007) Surgical treatment of tracheoinnominate fistula after stent- graft implantation. *J Thorac CardioVasc Surg.* 133:1641-1643.
- Nazari S, Manelli A, Gastaldo A, Rinaldo A, Barana L & Zonta A. (1990) A new vascular stapler for pulmonary artery anastomosis in experimental single lung transplantation. Video, Proceedings of the 4th Annual Meeting of the Association for Cardio-Thoracic Surgery, Naples, September 16-19, 1990
- Nazari S., Mourad Z, Luzzana F. (1994) Prosthetic substitution of the descending aorta without blood flow interruption. Proceedings of the IV Aortic Surgery Symposium, New York, April 20-22, 1994
- Nazari S, Luzzana F, Banfi C, Mourad Z, Salvi S, Gaspari A & Nazari-Coerezza F.(1996a) Expandable prosthesis for sutureless anastomosis in thoracic aorta prosthetic substitution. *Eur J Cardiothorac Surg.* 10:1003- 1009.
- Nazari S, Luzzana F, Carli F et al:(1996b) Rinforzo strutturale della parete aortica con una protesi a rete per arrestare la progressione dell'aneurisma e prevenirne la dissezione e la rottura. Sperimentazione sull'animale di una nuova modalit  terapeutica. *CHIRURGIA.* 9:412-23
- Nazari S, Luzzana F, Carli F et al (1996c) Aortic wall structural strenghtening by intraluminal net prosthesis to arrest aneurysm prograssion and to prevent dissection and rupture. Experimental assessment of a new therapeutic approach. *Eur J Cardiothor Surg.* 10:264-272
- Nazari S, Mourad Z, Banfi C, Salvi S, Visconti E, Aluffi A. (1996d) Composite graft with expandable ends for total arch replacement. Video & Poster, Proceedings Aortic Surgery Symposium V, New York, April 23-26, 1996
- Nazari S, Salvi S, Aluffi A, Visconti E, Rescigno G & Buniva P (1997) A new prosthesis for aortic arch substitution. *Ann Thorac Surg.* 64:1339-1344.
- Nazari S, Salvi S, Visconti E, Caramella F, Rossi C, Rescigno G, Banfi C & Buniva P. (1999) Descending aorta substitution using a prosthesis with expandable ends. Case report. *J Cardiovasc Surg (Torino)* 40:417-420.
- Nazari S, Thoracic Aorta Substitution in less than 2 minutes. (2006)Video, Proceedings 16th World Congress of World Society of Cardio- Thoracic Surgeons, Ottawa, August 17-20, 2006
- Nazari S. (2009) Modified Expandable Device for Easy and Realiabe Dissection Layers Approximation in Sutureless Aortic Anastomosis. Video, proceedings of The Houston Aortic Symposium, Houston, March 26-28, 2009
- Nazari S (2010) Expandable device type III for easy and reliable approximation of dissection layers in sutureless aortic anastomosis. Ex vivo experimental study. *Interact CardioVasc Thorac Surg.* 10:161-164; originally published online Nov 20, 2009; DOI: 10.1510/icvts.2009.216291

- Parodi JC, Palmaz JC & Barone HD (1991) Transfemoral intraluminal graft implantation for abdominal aortic aneurysms. *Ann Vasc Surg*. 5:491-9.
- Parodi JC. (1994) Endovascular repair of abdominal aortic aneurysms and other arterial lesions. *Surg Technol Int*. 3:431-6.
- Payr E. (1900) Beitrage zur Technik der Blutgefass und Nervennaht nebst Mittheilungentiber die Verwendung eines resorbierbaren Metalles in der Chirurgie. *Arch Klin Chir*; 62:67-93
- Pepper J, Golesworthy T, Utley M, Chan J, Ganeshalingam S, Lamperth M, Mohiaddin R & Treasure T. (2010) Manufacturing and placing a bespoke support for the Marfan aortic root: description of the method and technical results and status at one year for the first ten patients. *Interact Cardiovasc Thorac Surg*. 10:360-5. Epub 2009 Dec 11.
- Robicsek F & Thubrikar MJ (1994) Hemodynamic considerations regarding the mechanism and prevention of aortic dissection. *Ann Thorac Surg* 58:1247-1253
- Redaelli A & Fiore GB. Personal communication. Politecnico di Milano, 18 Gennaio 2011
- Rossella C, Rescigno G, Nazari S. (2008) Modified expandable device for easy, quick and blood-tight sutureless anastomosis in ascending aorta. *Proceedings of The Houston Aortic Symposium*, April 2008
- Ruby BJ & Cogbill TH (2007) Aortoduodenal fistula 5 years after endovascular abdominal aortic aneurysm repair with the Ancure stent graft. *J Vasc Surg*. 45:834-6.
- Schermerhorn ML, O'Malley AJ, Jhaveri A, Cotterill P, Pomposelli F, Landon BE. (2008) Endovascular vs. open repair of abdominal aortic aneurysms in the Medicare population. *N Engl J Med* 2008; 358: 464-474.
- Takata M, Watanabe G, Ohtake H, Ushijima T, Yamaguchi S, Kikuchi Y & Yamamoto Y (2011): Automatic aortic anastomosis with an innovative computer-controlled circular stapler for surgical treatment of aortic aneurysm. *J Thorac Cardiovasc Surg*. 141:1265-9
- Tanaka S, Kameda N, Kubo Y, Obatake N, Wakasa T, Ohsawa M & Wakasa K. (2009) Secondary aortoduodenal fistula caused on the suture line of the wrapping. *Pathology International* 59: 598-600 doi:10.1111/j.1440-1827.2009.02414.x
- Tsagakis K, Pacini, D, Di Bartolomeo R et al (2011): Arch replacement and downstream stent grafting in complex aortic dissection: first results of an international registry. *Eur J CardioThor Surg*. 39:87-94
- Tesauro B. (1967) Impiego degli adesivi plastici e delle cucitrici meccaniche in chirurgia vascolare. *Atti del 698 Congresso della Societa` Italiana di Chirurgia*, Firenze 18-20 Ottobre 1967. In: Fegiz G, editor. *Archivio ed atti della Societa` Italiana di Chirurgia*. Roma: EMES, 1:663-790.
- Tesauro B & Persico G. (1979) Valutazione critica delle suture meccaniche in chirurgia vascolare. *Atti dell'818 Congresso della Societa` Italiana di Chirurgia*, Catania 8-11 Ottobre 1979. In: Fegiz G, editor. *Archivio ed atti della Societa` Italiana di Chirurgia*, Bologna: CLUEB, 1:633- 652.
- The UK EVAR Trial Investigators, Greenhalgh RM, Brown LC, Powell JT, Thompson SG, Epstein D, Sculpher MJ. (2010) Endovascular versus open repair of abdominal aortic aneurysm. *N Engl J Med* 2010; 362: 1863-1871.

- Wright KC, Wallace S, Charnsangavej C, Carrasco CH & Gianturco C (1985) Percutaneous endovascular stents: an experimental evaluation. *Radiology*. 156:69-72.
- Yoshioka T, Wright KC, Wallace S, Lawrence DD Jr & Gianturco C.(1988) Self-expanding endovascular graft: an experimental study in dogs. *AJR Am J Roentgenol*. 151:673-6.
- Zannini G (1967) Introduzione storica. In Atti del 69° Congresso della Società Italiana di Chirurgia, Firenze 18-20 Ottobre 1967. In: Fegiz G, editor. *Archivio ed atti della Società Italiana di Chirurgia*. Roma: EMES, 1:7-32

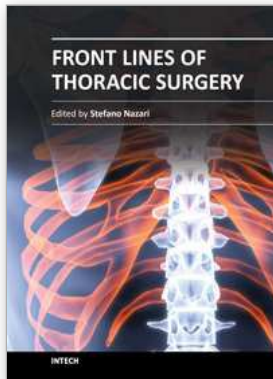

Front Lines of Thoracic Surgery

Edited by Dr. Stefano Nazari

ISBN 978-953-307-915-8

Hard cover, 412 pages

Publisher InTech

Published online 03, February, 2012

Published in print edition February, 2012

Front Lines of Thoracic Surgery collects up-to-date contributions on some of the most debated topics in today's clinical practice of cardiac, aortic, and general thoracic surgery, and anesthesia as viewed by authors personally involved in their evolution. The strong and genuine enthusiasm of the authors was clearly perceptible in all their contributions and I'm sure that will further stimulate the reader to understand their messages. Moreover, the strict adherence of the authors' original observations and findings to the evidence base proves that facts are the best guarantee of scientific value. This is not a standard textbook where the whole discipline is organically presented, but authors' contributions are simply listed in their pertaining subclasses of Thoracic Surgery. I'm sure that this original and very promising editorial format which has and free availability at its core further increases this book's value and it will be of interest to healthcare professionals and scientists dedicated to this field.

How to reference

In order to correctly reference this scholarly work, feel free to copy and paste the following:

Stefano Nazari (2012). New Approaches for Treatment and Prevention of Aortic Aneurysms, Front Lines of Thoracic Surgery, Dr. Stefano Nazari (Ed.), ISBN: 978-953-307-915-8, InTech, Available from: <http://www.intechopen.com/books/front-lines-of-thoracic-surgery/new-approaches-for-treatment-and-prevention-of-thoracic-aorta-aneurysms>

INTECH
open science | open minds

InTech Europe

University Campus STeP Ri
Slavka Krautzeka 83/A
51000 Rijeka, Croatia
Phone: +385 (51) 770 447
Fax: +385 (51) 686 166
www.intechopen.com

InTech China

Unit 405, Office Block, Hotel Equatorial Shanghai
No.65, Yan An Road (West), Shanghai, 200040, China
中国上海市延安西路65号上海国际贵都大饭店办公楼405单元
Phone: +86-21-62489820
Fax: +86-21-62489821

© 2012 The Author(s). Licensee IntechOpen. This is an open access article distributed under the terms of the [Creative Commons Attribution 3.0 License](#), which permits unrestricted use, distribution, and reproduction in any medium, provided the original work is properly cited.