

Robot Handling Fabrics Towards Sewing Using Computational Intelligence Methods

Zacharia Paraskevi

*University of Patras, Department of Mechanical Engineering & Aeronautics
Greece*

1. Introduction

In cloth making industry, the need for high flexibility in automation is really imperative due to the extensive style and material variation of the products and the fast fashion changes. The automated handling of fabric materials is one of the most challenging problems in the field of robotics, since it contains a vast potential for high productivity and cost reduction. The main difficulty to get full use of this potential is the fact that it is rather impossible to predict the behaviour of fabrics towards handling due to their low bending rigidity. Moreover, it is difficult to be modelled due to their unpredictable, non-linear and complex mechanical behaviour.

Sewing is the most important joining technology in garments and textiles manufacturing. The fact that sewing fabrics is a “sensitive” operation due to the erratic behaviour of fabrics poses barriers in the development of automated sewing systems. A solution to manipulation tasks that are afflicted with uncertainty, subjectivity, ambiguity and vagueness is an intelligent control approach. The development of intelligent control systems with vision feedback enables robots to perform skilful tasks in more realistic environments and make the research efforts for flexibility and automation really promising. Thus, industrial robots supported by machine vision and sensors can contribute towards advanced automation in apparel manufacturing.

On the other hand, sewing fabrics with the exclusive use of robots, without human intervention, is a complicated task. The stitching process is special in the sense that the error cannot be corrected after a part of the cloth has been stitched, implying that the stitching process is not reversible. This limitation implies that clothes that do not conform to the specifications are defective and should be withdrawn from the production. This imposes a great demand on precision during the sewing process. In practice, there is a predefined tolerance considered to be acceptable, as errors resulting from robot accuracy and camera resolution cannot be eliminated.

The main focus of this work lies on the design of an innovative intelligent robot controller based on visual servoing that aims to enable robots to handle flexible fabric sheets towards sewing. A great challenge is the design of a robot controller showing robustness against deformations that are likely to appear on the fabric towards robot handling. Special emphasis is given on robot handling fabrics comprised of curved edges with arbitrary curvature. This task is even harder, because up-to-date industrial robots present limitations in their movement, owing to the fact that they can only be programmed to make straight or circular motions.

2. Literature review on automated sewing systems

To the best of my knowledge, the published research work on robot handling fabrics with curved edges towards sewing is limited to few papers. A first approach to automating fabric manipulation was introduced by (Torgerson & Paul, 1988) including robotic motion control of various fabric shapes. The determination of robot motion paths is based on visual information defining the location of the fabric edges in world coordinates. However, no visual feedback was employed during the robot motion, making the method less accurate. The vision system detects the workpiece edge, extracts the boundary points, determines the parameters defining the geometry of the interior points, and computes the coordinates of the robot path points along subsequent linear and circular path segments. The error deviations between the desired seam line and the actual path line ranged between 3 and 5 mm. However, the flexibility of the method is limited owing to the fact that the path determination algorithms require a geometrical relationship between the robot end-effector and the workpiece to extract the edge parameters that are necessary for determining the robot motion. The FIGARO system (Gershon and Porat, 1988, 1986) performed handling and assembling operations using two superimposed servo control systems. The first system maintains a small tension moving the robot forward with the cloth and the second one rotates the cloth about the sewing needle to produce a seam parallel to the edges. The system performed best with shirting and worsted woven fabrics, which have a reasonable resistance in buckling. Robotic manipulation strategies have been investigated (Gershon, 1993) for handling limp materials proposing a parallel process decomposition of the robot sewing task (Gershon, 1990). A robot arm manipulates the fabric, modeled as a mass-spring-damper system, to modify its orientation and control the fabric tension during the sewing process, which was decomposed into four concurrent processes within a superposition parallel architecture.

After FIGARO system, an automated sewing system including two robots handling the fabric on the table was developed (Kudo et al., 2000). The nominal trajectories for both robots are defined through the definition of the points and are necessary for the programming of the robots. Visual information was used to improve tracking accuracy. Sewing along a curved line is achieved by translating the fabric in the sewing direction using the internal command for straight-line motion and simultaneously rotating about the needle according to the visual feedback information. The rotation angle is computed making use of the tangent of the cloth panel based on the method in reference (Gershon & Porat, 1988). The trajectory error was within the range of $\pm 0.5\text{mm}$.

A position-based visual servoing system for edge trimming of fabric embroideries by laser was proposed by (Amin-Nejad et al.). A tracking controller, decomposed into a feedforward controller in the tangential direction of the seam and a feedback controller in the normal direction, was implemented. The aim of the controller is to move the cutting beam along the seam with constant velocity and with a constant offset from it as a cutting tolerance. In the experimental results, three types of seam pattern, straight line, sinusoidal, and circular, were chosen for edge trimming. The accuracy achieved with this method was within $\pm 0.5\text{mm}$.

3. Sewing fabrics with straight edges

The present work is part of a project for the development of a robotic workcell for sewing fabrics. The project includes handling tasks (ply separation, translation, placement, folding, feeding and orientation), tension control and quality control of fabrics and stitches

(Koustoumpardis & Aspragathos, 2003; Koustoumpardis et al., 2006; Moulianitis et al., 1999; Zoumponos & Aspragathos, 2008). After the fabric has been placed at a random location on the working table, a number of sub-tasks should be performed before the sewing process starts. These preliminary sub-tasks are: the recognition of the fabric's shape, the extraction of the 'seam line', the detection of the edges targeted for sewing, planning of the stitching process and the location of the end-effector on the fabric (Koustoumparis et al., 2007). After the preprocess planning, the robot sewing process is considered and divided into three sub-tasks: the manipulation of the fabric towards the needle, the sewing of the seam segment and the rotation around the needle.

Concerning visual servoing, the developed vision system is a combination of image-based and position-based control system. The image-based analysis is used for the identification of the fabric's shape. After the image acquisition of the fabric, the features (vertices of the edges), the needle-point and the sewing line's orientation are derived from the image analysis. Besides, the position of the needle is also known in the robot coordinate system. The end-effector's position is unknown in the image coordinate system; however, the robot system gives feedback to the control system of the current end-effector's position in the robot base coordinate system. Moreover, the relation between the robot- and the image-coordinate system is known from the calibration of the camera. This approach makes the system more flexible and limits the calibration errors.

3.1 The sewing process

Initially, the fabric lies free of wrinkles at a random location on the work table. The camera captures the image of the fabric without the gripper on it in order to obtain the shape of the fabric and use it as the reference shape towards handling. The stitching process is performed on the *seam line* situated parallel to the specified fabric edges. The distance between the outer edge and the seam line, called *seam allowance*, depends on the cloth part and is defined by the apparel manufacturer. In practice, it usually ranges between 1/4 inch and 5/8 inch. After the seam edges of the fabric (dashed-line in Fig. 1) have been determined, the sewing process is ready to start. The sewing line is determined by the feeding mechanism. The sewing process can be decomposed in three separate tasks: transfer, stitching and rotation.

The movement towards the needle. After the robot touches the fabric at a proper location, the features, namely the vertices of the fabric, are extracted from the image taken from the camera. After the starting seam edge is identified, the vision system captures the distance (r) between the starting seam vertex and the sewing needle and the orientation angle (θ) formed by the starting seam segment and the sewing line (Fig. 1 (a)). The linear (u) and angular velocity (ω) of the robot end-effector are derived through the designed fuzzy decision system, described in Section 3.2. Given the time step dt and the angle φ , i.e. the orientation of r in the image coordinate system, the new position and orientation of the end-effector is computed by:

$$\begin{aligned}x' &= x + u \times \cos(\varphi) \times dt \\y' &= y + u \times \sin(\varphi) \times dt \\ \theta' &= \theta - \omega \times dt\end{aligned}\tag{1}$$

Therefore, the robot end-effector moves along the direction of r (defined by φ) and simultaneously rotates around the end-effector's z -axis, which is vertical to the table, until the angle becomes θ' (Zacharia et al., 2005). The fabric is transferred to a new position with

new orientation as a result of the movement and rotation of the end-effector, which is stuck on the fabric to avoid slipping between the gripper and the fabric. This motion stops when the seam segment reaches the needle with the desired orientation within an acceptable tolerance.

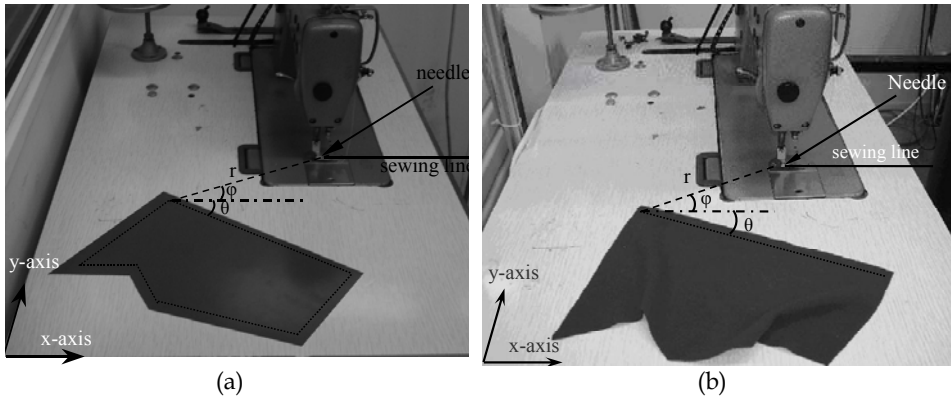

Fig. 1. Scene of the fabric lying on the work table (a) without deformations (b) with deformations

The stitching process. During sewing, the fabric is guided along the sewing line with a constant velocity, which should be the same with the velocity of the sewing machine, so that good seam quality is ensured. When the end-effector's velocity is higher than the sewing velocity, puckering will appear, whereas in the case where it is lower, low seam quality will be produced due to the tension increase. At each time step, the current image of the fabric is captured in order that the orientation error is determined. The orientation error is fed back to be corrected by rotating the fabric around the needle, while simultaneously the robot moves the fabric towards the direction of the sewing line. To circumvent the problem of uncertainty due to the distortions of the fabric's shape, fuzzy logic control is necessary. The inputs are the orientation error and its rate and the output is the rotation angle around the needle.

The rotation around the needle. When the seam segment coincides with the sewing line, the robot rotates the fabric around the needle until the next seam segment is aligned to the sewing line. It is worth noting that the end-effector is enforced to make a circular motion around the needle, since it has penetrated into the fabric. The orientation error (e_θ) of the next seam segment in relation to the sewing line and its time rate are the inputs to the fuzzy system that controls the rotation of the fabric around the needle, whereas the output is the angular velocity (ω) of the end-effector's motion around an axis perpendicular to the table at the needle-point.

3.2 The fuzzy robot control system

Since modeling the mechanical behavior of fabrics for real-time applications is rather difficult due to their low bending rigidity, an approach based on a fuzzy logic controller (FLC) is developed (Zacharia et al., 2009) considering the robustness and the fast response requirements. The block diagram for the control system is shown in Fig. 2, where the symbols in parentheses stand for the fuzzy system that controls the orientation of the end-

effector. The controller inputs are the position error (e_r) and the orientation error (e_θ), which are computed on the image, and their time rates (e'_r) and (e'_θ). The linear (u) and angular velocity (ω) of the end-effector around z-axis are the outputs.

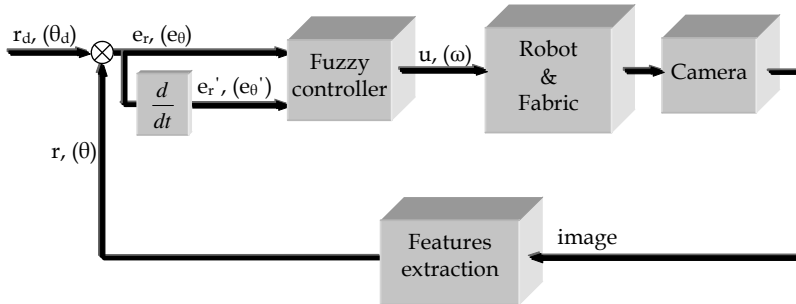

Fig. 2. The block diagram of the fuzzy logic control

The membership functions for the two inputs (Fig. 3 (a) and (b)) and the output of the system that controls the translation of the fabric towards the needle (Fig. 3 (c)) are experimentally tuned with various fabrics. Expert knowledge, often afflicted with uncertainty, is summarized in the proposition: *The larger the distance/angle and the smaller its change rate is, the faster the fabric should move/rotate.* The fuzzy associative memory (FAM) of the system that controls the translation of the fabric (Table 1) is derived after studying the behavior of the human workers towards sewing. For the rule evaluation, the “min” operator is used and for the aggregation mechanism the “max” operation is used. The centroid defuzzification method is used to determine the linear and angular velocity. Owing to space limitation, only the study for the system that controls the translation is presented.

position error rate	position error		
	SMALL	MEDIUM	LARGE
SMALL	Very Small	Medium	Very Large
MEDIUM	Very Small	Medium	Very Large
LARGE	Very Small	Small	Large

Table 1. Fuzzy Associative Memory (FAM) of the sewing system

An analytical model of the robot and the fabric is not necessary, since no geometrical characteristics are taken into account and there is no need for special mathematical computations for different fabrics. The proposed technique is feature-based, since only the features, r and u , are necessary for handling the fabric and can cope with the uncertainties that arise due to deformations. The proposed controller can handle possible deformations without changes in its structure achieving the desired accuracy on condition that the seam segment targeted for sewing is undistorted. Fig. 1 (b) shows the fabric of Fig. 1 (a), which has been deformed except for the seam segment targeted for sewing. It is clear from Fig. 1 (b) that the presence of deformations does not affect the control system, despite the fact that the shape of the fabric has significantly changed.

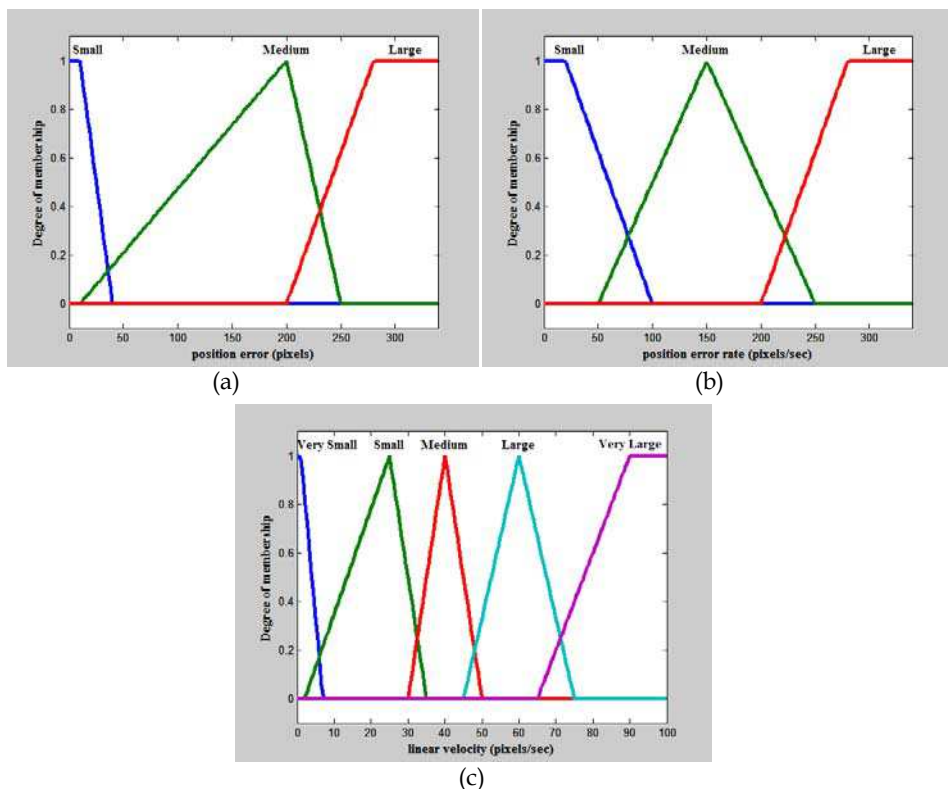

Fig. 3. The membership functions of (a) the position error (b) the position error rate (c) the linear velocity after manual tuning

4. Sewing fabrics with curved edges through a Genetic-based approach

Real fabric pieces used for cloth making consist of edges with arbitrary curvature. This fact gave an impetus to tackle the problem of robot-handling fabrics with curved edges. To robot-sew fabrics of different shapes and materials is a rather difficult task that requires system flexibility and good quality of the final product. To compensate for ensuing high machine-hour rates, a high throughput is vital if product costs are to be kept low. To enhance system flexibility and its efficiency to handle various fabrics, fuzzy logic and visual servoing control has been employed.

Curved edges pose additional difficulties in robot handling compared to straight edges, owing to the fact that up-to-date robots present limitations in their movements. The current industrial robots can only be programmed to perform straight or circular motions using internal commands. Sewing a fabric with arbitrary curvatures is a complicated task and can only be performed by approximating the curve with movements along straight-line segments (Zacharia et al., 2006). The robot makes a straight-line motion along the sewing line and a rotation around the needle-point simultaneously. This motion results in a smooth stitch that resembles the stitch produced by human operators.

4.1 Related work

In the field of pattern recognition, considerable research work has been done on the polygonal approximation of digital contours. Two main families of technique concerning the polygonal approximation of digital curves have been published: those that try to obtain an error-bounded polygonal approximation and those that search for a set of dominant points as vertices of the approximating polygon.

In the first family of methods, the main idea is to approximate a given curve with a minimal number of line segments such that the approximation error between the original curve and the corresponding line segments is less than a pre-specified tolerance. Several methods have been used for polygonal approximation, but most of them have the disadvantage that the results are dependent on the selection of the initial points and the arbitrary initial solution. To circumvent these drawbacks, nature-inspired algorithms have been proposed for polygonal approximation.

In the genetic algorithm presented in reference (Zhang & Guo, 2001), each chromosome is a binary string of fixed length. The chromosome represents a subset of the curve points, Where the i -th bit denoting the i^{th} original curve point is '1' if the corresponding curve point is taken as a vertex of the approximation polygon and '0' otherwise. The algorithm is improved based on Pareto optimal solution, and the results show that it is efficient and achieves less processing time compared to dynamic programming algorithms.

In reference (Yin, 2003), an ant colony search (ACS) algorithm for optimal polygonal approximation is developed. To apply the ACS, the underlying problem should be represented in terms of a graph. Apparently, for the polygonal approximation problem, each point on the curve should be represented as a node of the graph. A number of artificial ants are distributed on the graph and communicate with one another through the pheromone trails that are a form of the long-term memory guiding the future exploration of the graph. The authors compared the performance of the proposed method to those of genetic-based and tabu-search-based methods, and concluded that the numerical results are very encouraging.

A polygonal approximation approach of digital curves based on the particle swarm optimization (PSO) algorithm was presented by (Yin, 2004). In PSO - which belongs to the class of natural algorithms - each particle is presented as a binary vector corresponding to a candidate solution to the polygonal approximation problem. A swarm of particles are initiated and fly through the solution space for targeting the optimal solution. The experimental results manifest that their devised PSO algorithm is comparable to the genetic algorithm (GA), and it also outperforms other PSO versions in the literature for polygonal approximation.

In the second family of methods, the approximation does not depend on the starting point and is insensitive to changes of orientation and scale. A representative technique is the dominant point approach (Teh & Chin, 1989). This method focused on the determination of the region of support of every point of the curve, which is the region used in the calculation of each point's curvature. Thus, the method overcomes the problem of various scales in the curve's features. However, the Teh-Chin approach is not robust in the presence of noise. For the noise compensation, Wu proposed a modification of the method based on a dynamic determination of the region of support (Wu, 2002).

4.2 Sewing using polygonal approximation

The apparel manufacturer's requirements focus on time minimization for the accomplishment of the sewing process and satisfactory quality of seam, which is mainly based on stitch accuracy and smoothness. To fulfil these requirements, an algorithm based

on the polygonal approximation of the curved edges of the fabric is developed for robot handling fabrics towards the sewing process.

During the stitching process the robot's end-effector is commanded to make two motions simultaneously: a straight motion with constant speed (equal to the sewing machine's speed to ensure good seam quality) in the direction of the sewing line, and a rotation around the needle-point. Therefore, the final stitch is not a straight line, but a line that is yielded as a result of the combined end-effector's motion. After all the straight-line segments have been stitched, the deviation error is computed. Then, a new image is taken and the process is iterated. The stitching process stops when the whole curve has been sewn, i.e. when the last point reaches the needle.

The problem is formulated as follows: The curve section of the fabric is defined by N data points acquired by the vision system in the form of pixel coordinates in clockwise order, and can be described by a sequence of these points: $G=\{p_1, p_2, \dots, p_N\}$. Given the N data-points, find the optimal polygon that approximates the curve satisfying two criteria: the criterion for sewing time minimization and the criterion for acceptable accuracy. In this case, the time minimization is translated to the requirement for minimal length of the approximating polygon. Initially, a local search technique is developed to extract the dominant points and then a global search technique is applied taking the dominant points as inputs (Zacharia et al., 2008). The idea behind this is to filter out the initial curve points in an attempt to speed up the convergence of the algorithm. The proposed approach combines two algorithms to benefit from the advantages of each one.

The contribution of the work addressed in this Section is twofold. Firstly, a strategy for handling fabrics with curved edges towards the sewing process using a visual servoing controller is developed based on polygonal approximation. Secondly, the algorithms are further extended based on polygonal approximation that exhibited superiority in many other applications, and a new algorithm is proposed based on the dominant point detection approach and the genetic algorithm.

4.3 The proposed genetic-based approach

Genetic algorithms (GAs) (Michalewicz, 1996) have attracted attention in solving combinatorial optimization problems of high complexity because of their intrinsic parallelism and their effectiveness. The contribution of the proposed GA is a variable-length chromosome encoding scheme to reduce the computational time and memory requirement and the use of micro-GAs (Krishnakumar, 1989) as an approach for shortening the computational time. The traditional fixed length chromosomes could also be used to solve this problem, but it would lead to computational time increase, as the length of the chromosome would be too large to incorporate all the points comprising the curve. On the other hand, micro-GAs are ideally suited to optimization problems, where the emphasis is on quickly identifying a near-optimal region. In contrast to the traditional GA, the population size is small, yielding a much quicker convergence. Moreover, the micro-GA uses elitism and convergence checking with re-initialization to obtain the near-optimal solution. As a consequence, the proposed micro-GA with variable-length chromosomes can be used in a real-time application.

The evaluation mechanism: Given a maximum acceptable error ϵ_0 , find the polygonal approximation with the minimal number of vertices (corresponding to the minimum total length of the polygon), such that the polygon is distant from the curve by no more than ϵ_0 . It is worth noting that the algorithm searches in a set of N_s points that are the dominant points

defined by the dominant point detection approach. Consequently, the input for the micro-GA is the output of the dominant point detection approach.

Let $G^{**}=\{P_1, P_2, \dots, P_m\}$ be a subset of $G^*=\{P_1, P_2, \dots, P_{N_s}\}$, $G^{**} \subseteq G^*$, where $m (m < N_s)$ is the number of the vertices $P_i=(x_i, y_i)$ of the polygon that approximate the curve section captured in the current image. The function expressing the total length of a polygon with m vertices can be written as:

$$L_{total} = \sum_{i=1}^{m-1} L_i \tag{2}$$

and L_i is the length of the i_{th} edge of the polygon given by:

$$L_i = \|P_{i+1} - P_i\|^2 \tag{3}$$

The constraint that should be satisfied is expressed as the maximum deviation between the curve section and the approximating polygon section. For two points $P_i = (x_i, y_i)$ and $P_{i+1} = (x_{i+1}, y_{i+1})$ defining an edge of the polygon and a data point $p_j = (x_j, y_j)$ between P_i and P_{i+1} , the perpendicular distance of the arc point p_j to the chord $P_i P_{i+1}$ is computed by

$$\epsilon_j = \frac{|(P_{i+1} - P_i) \times (P_i - p_j)|}{|P_{i+1} - P_i|} \tag{4}$$

Consequently, the maximum deviation ϵ is found by:

$$\epsilon = \max(\epsilon_1, \epsilon_2, \dots, \epsilon_j, \dots, \epsilon_q) \tag{5}$$

where q is the number of the data points between P_i and P_{i+1} .

The fitness function is given by:

$$\text{fitness} = \begin{cases} \frac{1}{L_{total}}, & \text{if } \epsilon \leq \epsilon_0 \\ 0, & \text{otherwise} \end{cases} \tag{6}$$

where L_{total} is given by Eq.(2).

The representation mechanism: In this algorithm, variable-length chromosomes are defined to represent a polygon with m vertices approximating the curve. The maximum number of polygon vertices, defined by the user, is equal to ℓ , which is the maximum possible length of the chromosome. The encoding mechanism maps each approximating polygon to a string composed of integers is in the following form:

$$\underbrace{1 \ 10 \ 24 \ 49 \ 67 \ 92 \ 104 \ \dots \ i \ \dots \ N_s}_{m \text{ numbers}}$$

where $1 \leq i \leq N_s$, N_s is the number of the integer-coordinate data-points of curve section captured by the camera and m , where $m \leq \ell$, is the length of the chromosome representing the number of vertices of the approximated polygon. The integers i represent the rows of the matrix consisting of all the points $P_i=(x_i, y_i)$ in ascending order. Consequently, the genes of

the chromosome represent the curve data-points used to construct the polygon, i.e. the vertices of the polygon. It should also be mentioned that the first (1) and the last (m) row of the matrix are fixed for each chromosome.

Crossover: Crossover is a recombination operator and follows the reproduction. The individuals are randomly selected according to a predefined probability (crossover rate). The one-point crossover is modified, so that the produced offspring are feasible chromosomes. The cut-point lies between the first and the last gene of the parent chromosome with the minimum length. Next, the numbers at each string are reordered in order to appear in ascending order, so that the polygonal section is created by joining the successive points.

Population size: The population size depends on the nature and the complexity of the current problem. In this work, the proposed algorithm was tested for various small population sizes, so that both quick convergence and near-optimum solution are achieved. Finally, the selected population size is equal to 20.

5. Sewing fabrics with curved edges through ANFIS

One of the difficulties when applying the fuzzy approach of Section 4 is to obtain the fuzzy rules and the membership functions. In this Section, a neuro-fuzzy approach is introduced with the purpose of extracting fuzzy rules and the membership functions automatically. The proposed neuro-fuzzy approach combines the main components of soft computing (fuzzy logic, neural networks and genetic algorithms) that have shown great ability in solving complex control problems to benefit from the advantages of each one.

5.1 ANFIS framework

Fuzzy systems have the capability of translating the expert knowledge into linguistic rules inside a robust mathematical framework in order to draw conclusions and generate responses. However, a fuzzy model consisting of large number of if-then rules to map inputs to outputs is not desired due to the phenomenon of overfitting. Thus, the Takagi-Sugeno-Kang type fuzzy models (Sugeno & Kang, 1988; Takagi & Sugeno, 1985), known as TSK models, are widely used for control and modeling because of their high accuracy and relatively small models (Delgado et al., 2001; Männle, 2001).

When the system complexity is high, fuzzy modeling from input/output data is a useful way of creating FIS models. Because it is a more compact and computationally efficient representation than a Mamdani system, the Sugeno system using cluster information lends itself to the use of adaptive techniques for constructing fuzzy models with a minimum number of rules. Thus, data clustering algorithms were elaborated in order to construct FIS models from data, since they partition a collection of data into clusters based on similarity between data.

An adaptive neuro-fuzzy inference system, ANFIS, has been proposed in (Jang, 1993) to effectively deal with multivariable complex systems. ANFIS uses techniques like least squares or back propagation algorithms to determine the membership functions for a given input/output data set. These adaptive techniques can be used to customize the membership functions so that the fuzzy system best models the data. The effectiveness of using ANFIS for control and modeling has been pointed in (Jang et al., 1997; Rizzi et al., 1999).

This Section proposes an innovative approach for robot handling pieces of fabrics with curved edges towards sewing, which is based on learning. The fact that adaptive neuro-

fuzzy approaches have been successfully used for other applications in robotics (Marichal et al., 2001; Rusu et al., 2003; Hui et al., 2006) gave rise to the idea of using it for robot sewing fabrics of curved edges. The main purpose is to overcome difficulties arising from the fact that the fabric pieces have curved edges with arbitrary curvatures; thus, a learning technique is used. The proposed ANFIS based on genetic-oriented clustering combines the concepts of fuzzy logic and neural networks to form a hybrid intelligent system that enhances the ability to automatically learn and adapt. The system learns from the information obtained from the fabrics used for training and is able to respond to new fabrics, which had not been included in the training process.

5.2 Sewing tracking approach

The main scope of this Section is to provide a control system capable of dealing with different curvatures and thus, flexible to changes in fabrics' shape. To enhance system's flexibility and its efficiency to handle fabric edges with various curvatures, Artificial Intelligent techniques and visual servoing control are employed. Since there is no standardization for curved edges, a method is necessary for estimating the curve. However, searching for the equation that approximates the curve is a time-consuming procedure. In addition, such an approach would require curve estimation for each one curved edge for different fabrics.

The proposed system does not need any geometrical computations for estimating the curves, which would lead to computational burden and would, therefore, be prohibitive for using it in an on-line process. The developed control scheme is able to learn from the existed knowledge and respond to new curved edges.

Now, assume a piece of fabric with a curved edge of arbitrary curvature, as the one depicted in Fig. 4, which is guided for sewing. The camera captures an image that covers a small area in the vicinity of the sewing needle. The curved section captured in the image is approximated by an edge (AB) that joins the two endings of the curved section. Then, the distance d and the angle φ are extracted from the image. The feature d is the minimum distance between the needle-point and the straight edge that approximates the curved section. If the seam allowance is α , then the distance D , where $D=d-\alpha$, is the minimum distance between the seam line and the needle. The angle φ is defined by the straight edge that approximates the curve section and the sewing line (Zacharia, 2010).

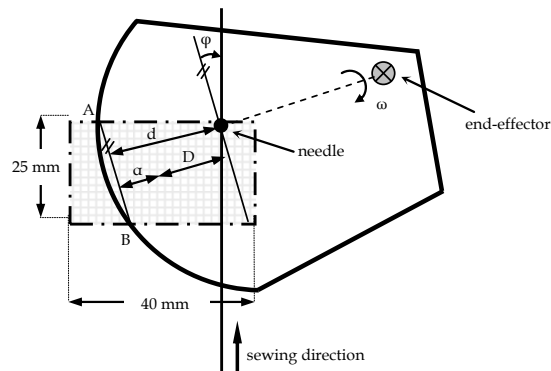

Fig. 4. Features extracted from the camera image

The position error is defined as $e_D = D - D_0$, where the desired distance is $D_0 = 0$ and the orientation error is defined as $e_\varphi = \varphi - \varphi_0$, where the desired angle is $\varphi_0 = 0$. To compensate for the seam errors (e_D and e_φ), the robot should be assigned to rotate around the needle with an angular velocity (ω) around z-axis. The angular velocity (ω) of the robot's end-effector is derived through a Sugeno-type fuzzy decision system, which takes as inputs the position error e_D and the orientation error e_φ .

The end-effector guides the fabric towards the sewing direction and the camera monitors the fabric to compensate for the seam error. The fuzzy controller, which is tuned through ANFIS, inputs the position and orientation error (e_D and e_φ) of the new fabric piece and outputs the predicted angular velocity (ω) of the robot's end-effector. Next, the robot is commanded to make a circular motion around the sewing needle by an angle θ and a translational motion in the sewing direction. The angle θ is derived by the relationship $\theta \approx \omega \cdot \Delta t$, where Δt is the sampling period.

5.3 Training using the modified ANFIS

The basic idea behind using neuro-adaptive learning techniques is that it is very simple and allows implementation of multi-input-single-output first order Sugeno-type FIS. This technique provides a method for the fuzzy modeling procedure to learn information about a data set, in order to compute the membership function parameters that best allow the associated fuzzy inference system to track the given input/output data. This learning approach takes place prior to the operation of the control system. The ANFIS methodology can be decomposed into four steps:

Data acquisition (Step 1): A number of different fabric pieces of various arbitrary curvatures are selected for experimental tests. During the sewing process, the position and orientation error in the image, as well as the end-effector's angular velocity are measured. As a result, a number of data sets, each one consisting of 3 attributes (e_D , e_φ and ω) obtained from the robot sewing process. These data sets are divided into training and checking data sets. It is worth noting that the position error (e_D), which is derived from the image, is computed in pixels and not in millimetres.

Genetic-oriented Clustering (Step 2): Clustering is used to generate a Sugeno-type fuzzy inference system that best models the data behavior using a minimum number of rules. The rules partition themselves according to the fuzzy qualities associated with each of the data clusters. The initial Sugeno-type FIS models are built by means of a genetic-oriented clustering approach using the training data set. In this approach, a Genetic Algorithm using variable-length chromosomes is applied to find the optimum number of cluster centers as well as the partitioning of the data. A comprehensive description of this algorithm can be found in (Zacharia & Aspragathos, 2008). This technique has the advantage over other clustering algorithms that the selection of the cluster centers is not limited to the data points and that it is able to escape from local optima, which is an inherent ability of Genetic Algorithms (GAs). Another advantage is the ability of automatically evolving the number of clusters due to the use of variable-length chromosomes in GA's structure. After applying the genetic-oriented clustering approach, the training data is partitioned into groups, called clusters, and as a result, simpler optimized FIS models with the minimum number of rules are obtained.

ANFIS architecture (Step 3): The purpose of this step is to optimize the initial FIS created by using the genetic-oriented clustering technique. A network-type structure similar to that of a neural network, which maps inputs through input membership functions and associated

parameters, and then through output membership functions and associated parameters to outputs can be used to interpret the input-output map. Considering a first-order Sugeno fuzzy model with two inputs x and y and one output f , a typical rule set with two fuzzy if-then rules can be expressed as

- Rule 1: *If (x is A_1) and (y is B_1) then ($f_1 = p_1x + q_1y + r_1$)*
- Rule 2: *If (x is A_2) and (y is B_2) then ($f_2 = p_2x + q_2y + r_2$)*

where x , y are inputs, A_i , B_i are membership functions and p_i , q_i , r_i are consequent parameters and i is the node number. The entire system architecture consists of five layers, namely, the fuzzy layer (Layer 1), product layer (Layer 2), normalized layer (Layer 3), consequence layer (Layer 4) and total output layer (Layer 5).

Model Validation (Step 4): The validation process is used to evaluate the model generalization capability. One problem with model validation is selecting a data set that is both representative of the data the trained model is intended to emulate, yet sufficiently distinct from the training data set so as not to render the validation process trivial. Especially in noisy measurements, it is possible that the training data set does not include all the representative features needed for the model. The idea behind using a checking data set for model validation is that after a certain point in the training, the model begins overfitting the training data set. Overfitting can be detected when the checking error starts increasing while the training error is still decreasing. In practice, the experimental data is divided into training data and checking data. The training data is used in both genetic-oriented clustering process and ANFIS training. The checking data is only used in ANFIS training to prevent the model from overfitting.

6. Experimental results

The experiments were carried out using a robotic manipulator with 6 rotational degrees of freedom (RV4A) and controlled by a PC. The robot is programmed in Melfa-Basic language in Cosirop environment, while the analysis of the visual information is performed with Matlab 7.1. The vision system consists of a Pulnix analog video camera at 768×576 pixels resolution RGB and a analog camera of the same resolution, which are fixed above the working table in a vertical position (Fig. 5). The vision is transferred to the second camera when the position error becomes less than 10 pixels (≈ 12.3 mm) and the orientation error is less than 5° . Using the second camera, the accepted position and orientation error are set equal to 10 pixels (≈ 1.389 mm) and 1° , respectively. A simple gripper has been designed, so that the arm of the robot is distant from the fabric, as shown in Fig. 5. The fabric is stuck on the gripper to avoid slipping; however, the placement of the gripper onto the fabric is out of the reach of this work.

In this work, buckling modes during robot handling are supportable on the condition that it does not appear in the segment to be sewed. However, it still remains a problem that should be avoided. Thus, the position where the gripper touches the fabric is estimated in terms of reducing the possibilities for deformation appearance, taking into account the properties of the fabric (Koustoumpardis & Aspragathos, 2003). It is worth noting that the intent of this work deals with buckling in context of achieving a successful seam tracking and not the correction strategy against folding or wrinkling problems. The experimental tests also showed that deformations are likely to appear close to the gripper position on the fabric, and not on the edge.



Fig. 5. The experimental stage

Since there is no standardization for deformations, it is difficult to be quantified. However, the greater deformation observed in buckling is about 30 mm, which is the height between the highest and the lowest point of the fabric. In some cases, fabrics were 'partially folded'. In other cases, the wrinkles induced the fabric to fold due to its own weight forming a loop at one side of the fabric. In some experiments, the fabric presented simultaneously both wrinkles, and folds.

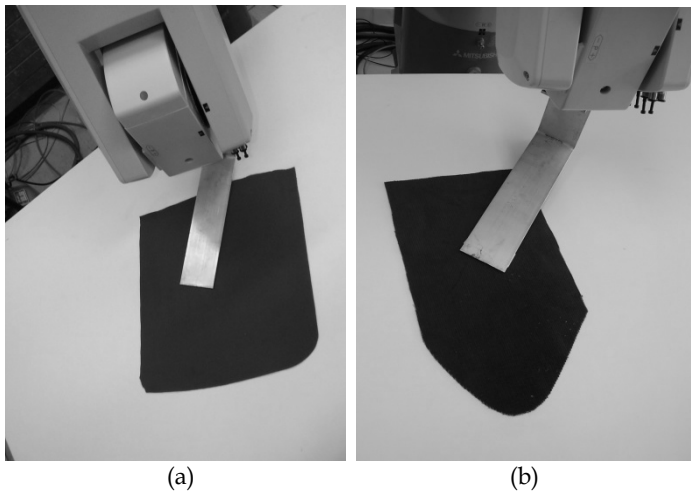

Fig. 6. Fabric A with curved edge of small curvature (a) Fabric B with curved edge of large curvature

In the experiments, a considerable number of fabric pieces of different materials, shape and colour have been used. Both simulation and experimental tests are conducted to verify the efficiency of the proposed approach. A fabric piece is indicatively presented to show the results for both simulation and experimental tests. The shape of this fabric consists of two

straight-line segments and an arbitrary curve, its colour is red and it has medium bending rigidity (Fig. 6 (a)).

Initially, simulation tests were carried out in order to approve the effectiveness of the proposed polygonal approximation based on a micro-Genetic Algorithm (micro-GA). A number of points along a section of the curved edge are captured by the camera that focuses on the area of the needle-point. The array that contains the curve data-points has dimensions 185×2 and is the input to the micro-GA. The maximum length of the chromosomes is set to 6 and the maximum acceptable deviation is arbitrarily set to 8 pixels (≈1 mm).

Fig. 7 (a) shows the optimum polygon section resulted from the micro-GA, which approximates the given data-points of the curved edge. The curve section is approximated by a polygon section consisted of three sides and each of them deviates from the corresponding arc section 6.87, 5.55 and 7.07 pixels. Increasing the maximum acceptable deviation from 8 pixels to 12 pixels, the arc section is approximated by a polygon section with three sides, as shown in Fig. 7 (b), where the maximum deviation errors between the curve and each polygon side are 4.48, 5.88 and 10.37 pixels, respectively. Decreasing the maximum acceptable deviation to 4 pixels, the arc is approximated by a polygon section with six sides, as shown in Fig. 7 (c), where the maximum deviation errors are 3.37, 2.52, 2.32, 0.88, 3.15 and 3.08 pixels. Fig. 7 (d) zooms in the first two sides of the polygon shown in Fig. 7 (c).

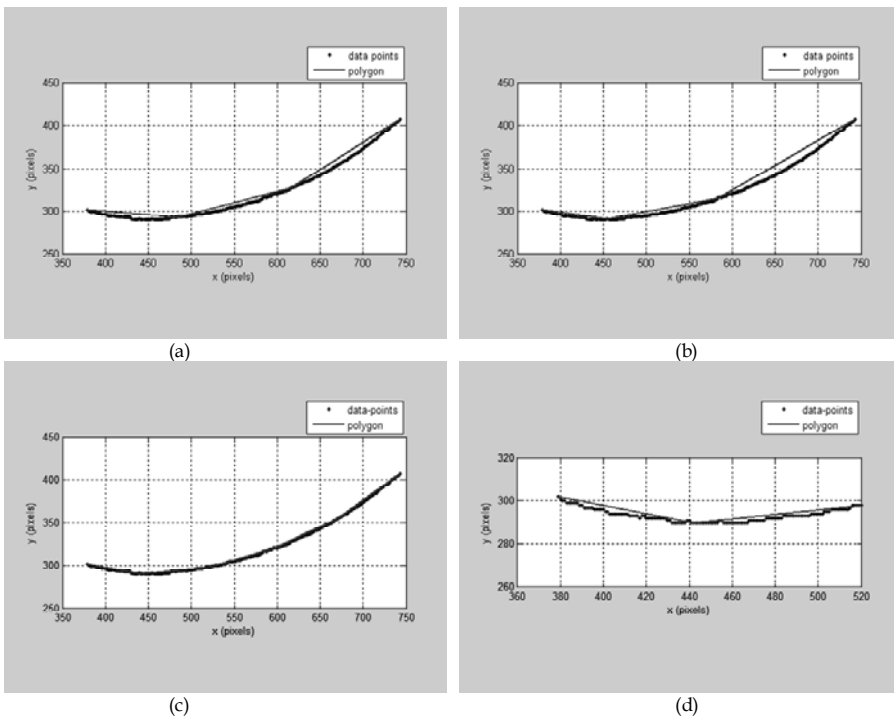

Fig. 7. Polygonal approximation with (a) $\epsilon=8$ pixels (b) $\epsilon=12$ pixels (c) $\epsilon=4$ pixels (d) detail of the approximation with $\epsilon=4$ pixels

These simulation tests demonstrate that the polygon approximation of the curve serves as a trade-off between rapidity and smoothness affected by the tolerance for imprecision. The results show that the approximation leads to a satisfactory seam approximation, while simultaneously the time for the entire process is minimized.

In practice, the sewing process is repeated many times and the deviation errors are collected and processed. The maximum acceptable deviation error for all tested cases is set to 8 pixels (≈ 1 mm). Fig. 8 (a) shows the deviation errors for Fabric A, a fabric piece with small curvature (Fig. 6 (a)) and Fig. 8 (b) shows the deviation errors for Fabric B, a fabric piece with small curvature (Fig. 6 (b)).

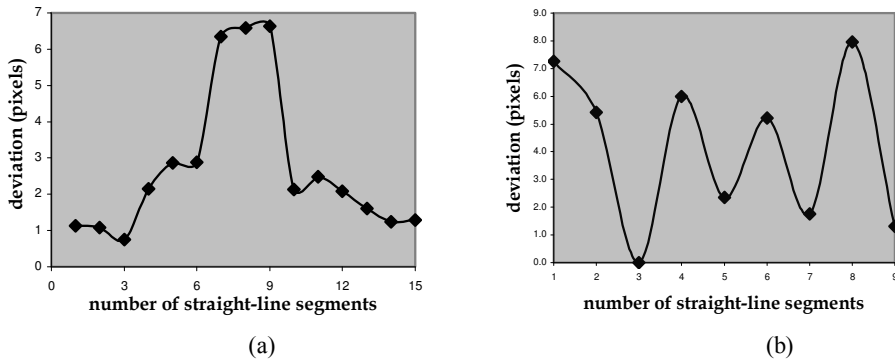

Fig. 8. Deviation between real and desired path using the micro-GA for (a) fabric A (b) fabric B

Fabric A: The proposed micro-GA is experimentally tested using the dominant points as input. The maximum deviation (in pixels) between the needle-point and polygon approximation is computed from the image captured. The sewing process for the curved edge is accomplished after 15 steps and the results are shown in Fig. 8 (a). The maximum deviation is 6.63 pixels (≈ 0.83 mm) and is lower than the maximum acceptable limit of 8 pixels. The average value for the deviation is 2.75 pixels (≈ 0.34 mm), which is really satisfactory. The steps 6-10 correspond to the part of the curve with high curvature.

Fabric B: Using the dominant points as input, the micro-GA terminates with 9 steps and the average value for the deviation is 4.14 pixels (≈ 0.52 mm). The maximum deviation for each method is depicted in Fig. 8 (b). The deviation error for this fabric piece is greater compared to the previous one, which is reasonable, since the curvature is higher.

More fabric pieces are used to test the proposed approach, but detailed results are not presented due to the space limit. Table 2 shows indicatively the total steps, as well as the average and maximum deviations for some of the tested fabrics. The task is accomplished in less steps (corresponding to lower total time) when the micro Genetic-based approach that uses the dominant points as input is applied, satisfying the predefined boundary of 1 mm.

In apparel industry, the maximum allowable deviation, which is empirically evaluated, lies in the range between 0.5-5 mm. For all tested cases, the proposed algorithm is proved to be quite robust and efficient, since the achieved deviation, which is the maximum predefined deviation set by the user, is less than 1 mm. Bearing in mind that the robot accuracy is within ± 0.03 mm, the deviations resulting from the vision- and the robot position errors are very satisfactory.

Fabric type/color	Steps	Maximum deviation (mm)	Average deviation (mm)
fleece/red	15	0.83	0.34
cotton/green	9	1.00	0.52
jeans/blue	10	0.99	0.65
baize/green	10	0.79	0.34
tweed	10	0.96	0.58

Table 2. Experimental results for the tested fabrics

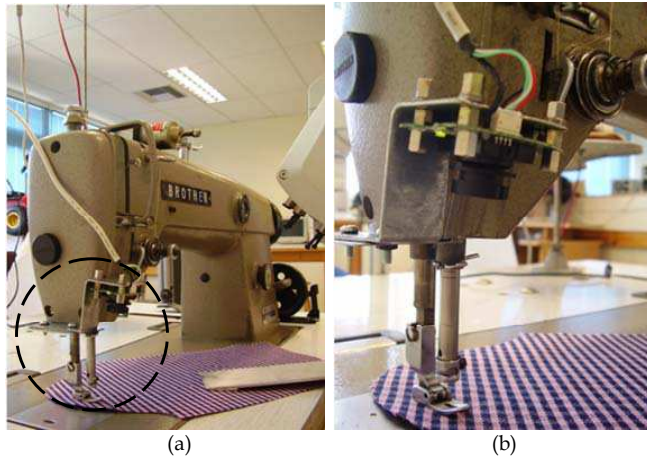

Fig. 9. (a) Robot-camera-sewing machine system (b) zoom in the camera

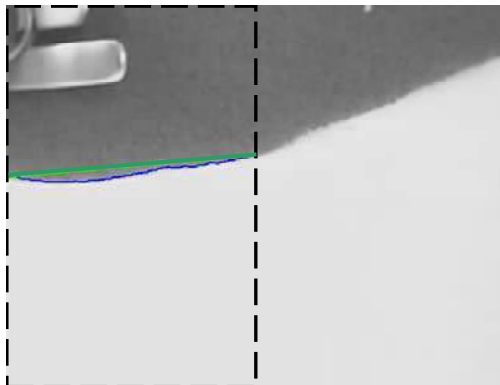

Fig. 10. Identification of a curved section

To test the ANFIS system, the robot-camera-sewing system is restructured to achieve even better accuracy (Fig. 9). Now, the vision system consists of a web camera at 480×640 pixels resolution RGB, which is mounted on the sewing machine, so that the area in the vicinity of the sewing needle is in the field of view of the web camera. The area captured by the web camera is about 40×55 mm, but the seam errors (e_D and e_ϕ) are computed in a smaller area

40×25 mm for a better approximation. Fig. 10 presents indicatively a curved section of a fabric, which is identified and approximated by a straight edge.

The proposed seam control strategy is tested using real fabric pieces of different materials, shapes and colours. Fig. 11 shows four fabric pieces with curved edges that were used for training and Fig. 12 shows three fabric pieces that were used for testing. Several experimental tests are conducted to verify the efficiency and approve the effectiveness of the proposed adaptive neuro-fuzzy approach for robot sewing fabrics of curved edges.

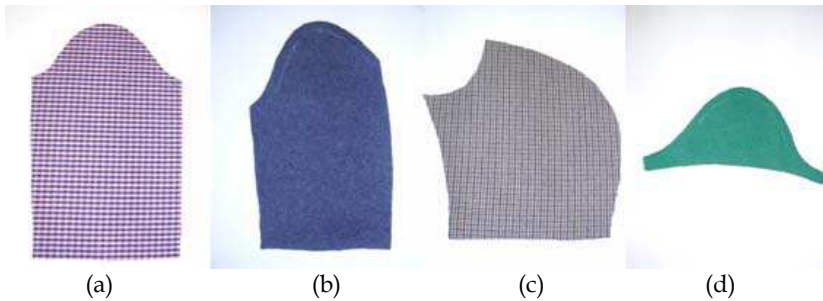

Fig. 11. (a) jacket's sleeve (b) shirt's sleeve (c) trouser's leg (d) short sleeve

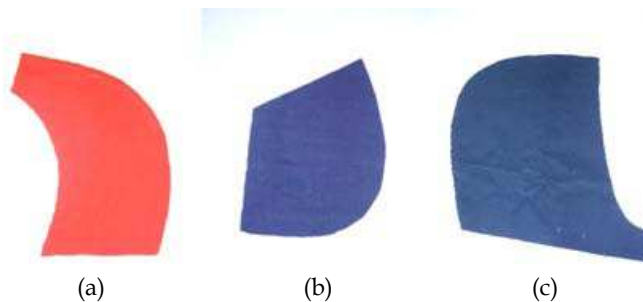

Fig. 12. (a) skirt's piece (b) pocket (c) hood

Using the fabric pieces shown in Fig. 11, a total of 350 data sets are obtained. A total of 300 data sets are selected for the purpose of training in ANFIS and the rest 50 data sets are selected for testing purposes after the training is completed in order to verify the accuracy of the predicted values.

Next, the genetic-oriented clustering method is applied to the training data set. Fig. 13 shows the training data sets and the resulting cluster centers obtained after applying the genetic-oriented clustering method. The cluster centers determine the number of the fuzzy sets and the parameters (mean values) μ of the Gaussian membership functions of the antecedent part, as well as the number of fuzzy rules of the Sugeno-type FIS. The number of the resulted clusters for $r_a=0.4$ is seven. As a result, each input variable is characterized by seven fuzzy sets with the linguistic values {Extremely Small (ES), Very Small (VS), Small (S), Medium (M), Large (L), Very Large (VL), Extremely Large (EL)}. The consequent parameters of each rule of the Sugeno-type FIS are determined by using the linear least-squares algorithm. The membership functions for the two inputs resulting from these cluster centers

are shown in Fig. 14 (a). The rule base obtained through the genetic-oriented clustering approach consists of 7 rules, shown in Table 3.

1. If (e_D is *Small*) and (e_ϕ is *Extremely Small*) then (ω is *Extremely Small*) (1)
2. If (e_D is *Very Small*) and (e_ϕ is *Small*) then (ω is *Very Small*) (1)
3. If (e_D is *Extremely Small*) and (e_ϕ is *Extremely Large*) then (ω is *Small*) (1)
4. If (e_D is *Large*) and (e_ϕ is *Very Small*) then (ω is *Medium*) (1)
5. If (e_D is *Medium*) and (e_ϕ is *Large*) then (ω is *Large*) (1)
6. If (e_D is *Very Large*) and (e_ϕ is *Medium*) then (ω is *Very Large*) (1)
7. If (e_D is *Extremely Large*) and (e_ϕ is *Very Large*) then (ω is *Extremely Large*) (1)

Table 3. Fuzzy rule base

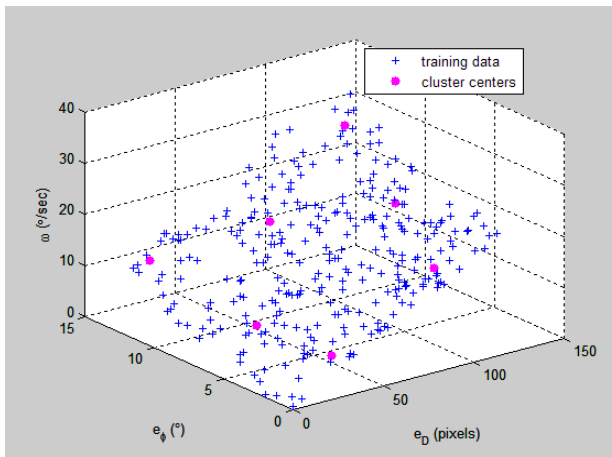

Fig. 13. Cluster centers resulting from the genetic-oriented clustering method

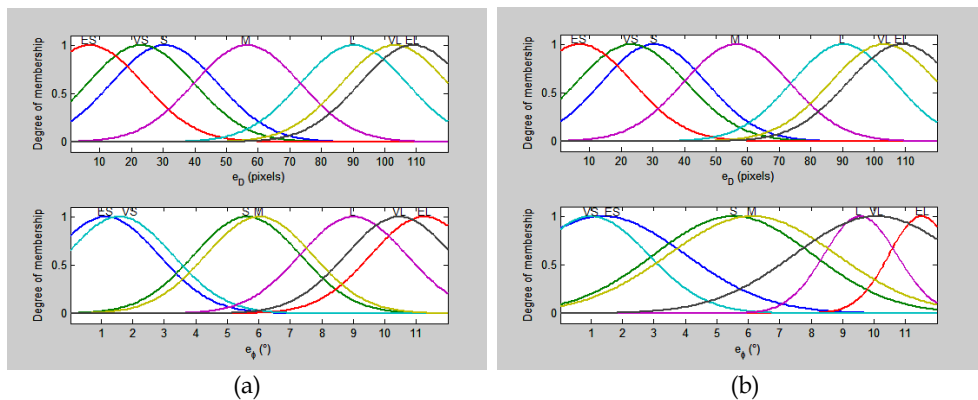

Fig. 14. The membership functions for inputs using (a) genetic-based clustering (b) ANFIS

The next step is the training process that aims at tuning the fuzzy inference system. Fig. 14 (b) shows the final Gaussian membership functions derived after training the system. In contrast to the first input, there is a considerable change in the final membership functions concerning the second input, since the supports of all fuzzy sets are broadened. The root mean squared errors of the output over 100 training epochs, which are obtained by using 300 training datasets and 50 checking data sets, are plotted in Fig. 15. It is obvious that both training and checking error gradually decrease versus the number of epochs.

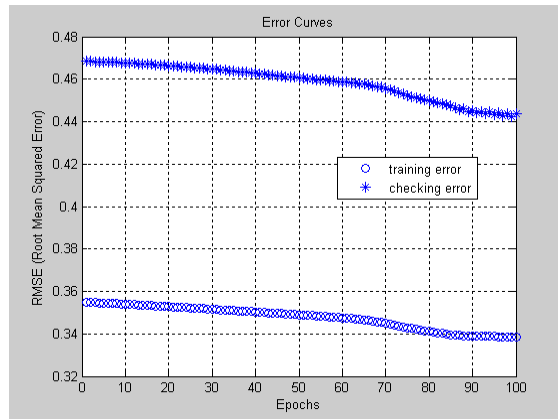

Fig. 15. ANFIS training process

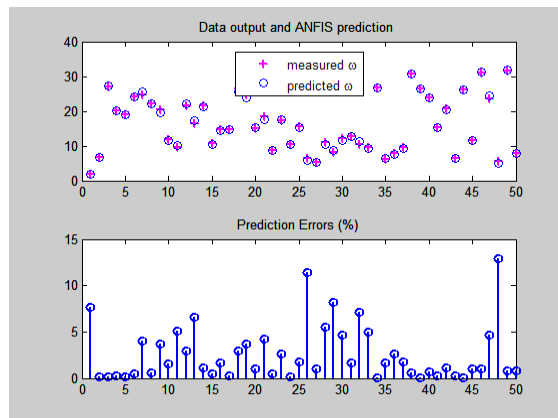

Fig. 16. Comparisons between measured & predicted angular velocity

After 50 checking data sets are entered in ANFIS, an output value can be obtained from the calculation results. This output value is the predicted value for the angular velocity of the end-effector. Fig. 16 shows measured and predicted angular velocity for the checking data, as well as the prediction error expressed as the absolute value of the percentage error between the measured and predicted angular velocity. These two diagrams demonstrate that the predicted values are close to the experimentally measured values, as many of the

data points fall very close to the predicted points, indicating good correlation. The average error of the prediction of the angular velocity is around 2.57%, which means that the accuracy is as high as 97.43%.

An interesting and important conclusion established from the results is that the proposed approach is capable of well estimating data points outside the training space using the advantages of fuzzy logic, neural networks and genetic algorithms. This conclusion reflects the model's ability to predict the output based on the input data used for training. In practice, this implies that the method is effective in robot handling fabrics with curved edges, which have not been used in the training process.

The strategy for robot-sewing fabrics with curved edges described above has the advantage of performing well regardless of the fabric's deformations. This advantage is of major importance, as fabrics are limp materials that have a tendency to distort and change their shape when handled on a work table. The fact that this approach is based on the information taken from the image that captures the fabric in the neighbourhood of the needle amplifies the system's robustness against deformations. Therefore, deformations that may appear on the fabric during robot handling do not affect the effectiveness of the stitching process.

7. Conclusion

The main focus of this work lies on the design of an innovative visual servoing manipulator controller based on Fuzzy Logic that aims to enable robots to handle flexible fabric sheets lying on a work table. Visual servoing and fuzzy logic are used in robot motion control increases the intelligence of robots and the flexibility of the system. The designed visual servoing control system can deal with a variety of fabrics that are likely to deform and can cope with possible deformations due to buckling (wrinkling, folding) towards handling without degrading its performance, on condition that the seam segment to be sewed is undistorted. The desired accuracy is achieved in approaching the needle even in cases where deformations appeared.

This work focuses on the difficult case, where fabrics consist of edges with arbitrary curvatures. The need for approximating the curved edges through straight lines arises from the fact that current industrial robots can only be programmed to make straight or circular motions. From the standpoint of apparel industry manufacturing, it is important to assure that the fabric is sewn in the minimum time, while simultaneously satisfactory accuracy and smoothness are achieved.

In our approach, the curve is approximated through small straight segments applying a micro-GA approach that uses the dominant point detection method as input. The proposed approach aims at the minimization of the execution time satisfying a predefined maximum tolerance. Based on the results, some consideration is made concerning the trade-offs between running times and the quality of the final approximation.

To alleviate the computational burden of geometrical computations, an innovative method for robot handling fabrics with curved edges towards sewing has been proposed, which is based on a novel genetic-oriented clustering method and an adaptive neuro-fuzzy inference system. This work presents the design and tune of an ANFIS network with the minimum number of fuzzy rules for modelling the complex process of robot sewing fabrics. The proposed adaptive neuro-fuzzy inference system benefits from the advantages of fuzzy logic, neural networks and genetic algorithms. This feature makes this approach a powerful

tool to deal with uncertainty embedded in the curved edges of real cloth parts and to cope with new fabric pieces that have not been used for the training process.

The experimental results show that the proposed control scheme is effective and efficient in guiding the fabric towards the sewing needle, sewing it and rotating it around the needle. After extensive experimentation, it has been proved to be rather simple, flexible and robust due to its capability to respond to any position and orientation error for a variety of fabrics that are likely to present deformations. The experimental data were obtained using the robot-camera-sewing machine system and real parts of cloths. The proposed method presented good results when applied to fabrics with curved edges of unknown curvatures, which manifest the validity of proposed approach. This method is applicable to any piece of fabric with edges of arbitrary curvature, since it has been proved to be efficient in estimating the appropriate angular velocity of fabrics that were not included in the training process. Although no direct comparison with human stitching is possible, as the equipment deployed attained differ, the achieved accuracy is really promising for future use in industrial applications.

8. Acknowledgment

The author would like to acknowledge Robotics Group of Mechanical Engineering & Aeronautics Dep., University of Patras (<http://robotics.mech.upatras.gr/www/>) for help and cooperation.

9. References

- Amin-Nejad, S.; Smith, J.-S. & Lucas, J. (2003). A visual servoing system for edge trimming of fabric embroideries by laser, *Mechatronics*, Vol.13, No.6, pp.533-551.
- Delgado, M.R.; Von Zuben, F. & Gomide, F. (2001). Hierarchical genetic fuzzy systems, *Information Sciences*, Vol.136, No.1, pp.29-52.
- Gershon, D. & Porat, I. (1986). Robotic sewing using multi-sensory feedback, *Proceedings of the 16th International Symposium of Industrial Robots*, Brussels, pp. 823-34.
- Gershon, D. & Porat, I. (1988). Visual servo control of a robotic sewing system, *Proceedings of the IEEE International Conference on Robotics and automation*, pp.1830-1835, Philadelphia, PA, USA.
- Gershon, D. (1990). Parallel process decomposition of a dynamic manipulation task: robotic sewing, *IEEE Transactions on Robotics and Automation*, Vol.6 No.3, pp. 357-366.
- Gershon, D. (1993). Strategies for robotic handling of flexible sheet material, *Mechatronics*, Vol.3 No.5, pp. 611-23.
- Hui, N.B.; Mahendar, V. & Pratihar, D.K. (2006). Time-optimal, collision-free navigation of a carlike mobile robot using neuro-fuzzy approaches, *Fuzzy Sets and Systems*, Vol.157, No.16, pp.2171-2204.
- Jang, J.-S.R. (1993). ANFIS: Adaptive network-based fuzzy inference system, *IEEE Transactions on Systems, Man and Cybernetics*, Vol.23, No.3, pp.665-685.
- Jang, J.-S.R.; Sun, C.-T. & Mizutani, E. (1997). *Neuro-Fuzzy and Soft Computing: A Computation Approach to Learning and Machine Intelligence*, Prentice Hall, Upper Saddle River.

- Koustoumpardis P.; Zacharia P. & Aspragathos N. (2007). Intelligent robotic handling of fabrics for sewing, *Industrial Robotics: Programming, Simulation and Applications*, pIV pro literature Verlag Robert Mayer-Scholz, Chapter 28, pp.559-582, February.
- Koustoumpardis, P. & Aspragathos, N. (2003). Fuzzy logic decision mechanism combined with a neuro-controller for fabric tension in robotized sewing process, *Journal of Intelligent and Robotic Systems*, Vol.36 No.1, pp.65-88.
- Koustoumpardis, P.; Zoumponos, G.; Zacharia, P.; Mariolis, I.; Chatzis, I.; Evangelidis, G. & Zampetakis, A. (2006). Handling of non-rigid materials (XROMA), application in robotic sewing, *37th International Symposium on novelties in Textiles*, pp.528-533, Ljubljana, Slovenia, June 15-17, 2006.
- Krishnakumar, K. (1989). Micro-genetic algorithms for stationary and non-stationary function optimization. *SPIE Intelligent Control and Adaptive Systems*, Vol.1196, pp.289-296.
- Kudo, M.; Nasu, Y.; Mitobe, K. & Borovac, B. (2000). Multi-arm robot control system for manipulation of flexible materials in sewing operation, *Mechatronics*, Vol.10, No.8, pp.371-402.
- Männle, M. (2001). FTSM—Fast Takagi-Sugeno Fuzzy Modeling, Institute for Computer Design and Fault Tolerance, University of Karlsruhe, Karlsruhe.
- Marichal, G.N.; Acosta, L.; Moreno, L.; Méndez, J.A.; Rodrigo, J.J. & Sigut, M. (2001). Obstacle avoidance for a mobile robot: a neuro-fuzzy approach, *Fuzzy Sets and Systems*, Vol.124, No.2, pp.171-179.
- Michalewicz, Z. (1996). *Genetic Algorithms + Data Structures = Evolution Programs*, 3rd edition, Springer-Verlag.
- Moulianitis, V.; Dentsoras, A. & Aspragathos, N. (1999). A knowledge-based system for the conceptual design of grippers for handling robots, *Artificial Intelligence for Engineering Design, Analysis and Manufacturing*, Vol.13, No.1, pp. 3-25.
- Rizzi, A.; Mascioli F.M.F. & Martinelli G. (1999). Automatic training of ANFIS networks, *IEEE International Fuzzy Systems Conference*, Seoul, Korea, Vol.3, pp.1655-1660, ISBN: 0-7803-5406-0.
- Rusu, P.; Petriu, E.M.; Whalen, T.E.; Cornell, A. & Spoelder H.J.W. (2003). Behaviour-based neuro fuzzy controller for mobile robot navigation, *IEEE Transactions on Instrumentation and Measurement*, Vol.52, No.4, pp.1335-1340.
- Sugeno, M. & Kang, G.T. (1988). Structure identification of fuzzy model, *Fuzzy Sets and Systems*, Vol.28, No.1, pp.15-33.
- Takagi, T. & Sugeno, M. (1985). Fuzzy identification of systems and its applications to modeling and control, *IEEE Transactions on Systems, Man and Cybernetics*, Vol.15, No.1, pp.116-132.
- Teh, C. H. & Chin, R. T. (1989). On the detection of dominant points in digital curves, *IEEE Transactions on Pattern Analysis and Machine Intelligence*, Vol.11, No.8, pp.859-872.
- Torgerson, E. & Paul, F.-W. (1988). Vision-guided robotic fabric manipulation for apparel manufacturing, *IEEE Control Systems Magazine*, Vol.8, No.1, pp.14-20.
- Wu, W.-Y. (2002). A dynamic method for dominant point detection, *Graphical Models*, Vol.64, No.5, pp.304-315.
- Yin, P.-Y. (2003). Ant colony search algorithms for optimal polygonal approximation of plane curves, *Pattern Recognition*, Vol.36, No.8, 1783-1797.

- Yin, P.-Y. (2004). A discrete particle swarm algorithm for optimal polygonal approximation, *Journal of Visual Communication and Image Representation*, Vol.15, No.2, pp.241–260.
- Zacharia P.Th. (2010). An adaptive neuro-fuzzy inference system for robot handling fabrics with curved edges towards sewing, *Journal of Intelligent and Robotic Systems*, Vol.58, No.3, pp.193-209.
- Zacharia, P.; Mariolis, I., Aspragathos, N. & Dermatas, E. (2005). Visual servoing of a robotic manipulator based on fuzzy logic control for handling fabric lying on a table, *I*PROMS Virtual Conference on Innovative Production Machines and Systems*, , pp. 411–416, July 4–15, 2005.
- Zacharia, P.; Mariolis, I., Aspragathos, N. & Dermatas, E. (2006). Visual servoing controller for robot handling fabrics of curved edges, *I*PROMS Virtual Conference on Innovative Production Machines and Systems*, pp. 301–306, July3–14, 2006.
- Zacharia, P.Th. & Aspragathos, N.A. (2008), Genetically oriented clustering using variable length chromosomes, *I*PROMS Virtual International Conference on Intelligent Production Machines and Systems*, pp.204-209, July 1-14, 2008.
- Zacharia, P.Th.; Mariolis, I.G.; Aspragathos, N.A. & Dermatas E.S. (2008). Robot handling fabrics with curved edges based on visual servoing and polygonal approximation, *Special Issue of Proceedings of the Institution of Mechanical Engineers, Part B, Journal of Engineering Manufacture*, Vol.222, No.10, pp. 263-1274.
- Zacharia, P.Th.; Mariolis, I.G.; Aspragathos, N.A. & Dermatas E.S. (2009). A robotic system based on fuzzy visual servoing for handling flexible sheets lying on a table, *Industrial Robot*, Vol. 36, No.5, pp.489-496.
- Zhang, H. & Guo, J. (2001). Optimal polygonal approximation of digital planar curves using meta heuristics, *Pattern Recognition*, Vol.34, No.7, pp.1429–1436.
- Zoumponos, G. & Aspragathos, N. (2008). Fuzzy logic path planning for the robotic placement of fabrics on a work table, *Robotics & Computer-integrated Manufacturing*, Vol.24, No.2, pp.174-186.

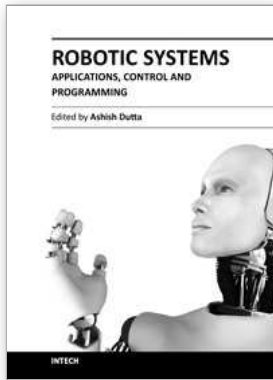

Robotic Systems - Applications, Control and Programming

Edited by Dr. Ashish Dutta

ISBN 978-953-307-941-7

Hard cover, 628 pages

Publisher InTech

Published online 03, February, 2012

Published in print edition February, 2012

This book brings together some of the latest research in robot applications, control, modeling, sensors and algorithms. Consisting of three main sections, the first section of the book has a focus on robotic surgery, rehabilitation, self-assembly, while the second section offers an insight into the area of control with discussions on exoskeleton control and robot learning among others. The third section is on vision and ultrasonic sensors which is followed by a series of chapters which include a focus on the programming of intelligent service robots and systems adaptations.

How to reference

In order to correctly reference this scholarly work, feel free to copy and paste the following:

Zacharia Paraskevi (2012). Robot Handling Fabrics Towards Sewing Using Computational Intelligence Methods, *Robotic Systems - Applications, Control and Programming*, Dr. Ashish Dutta (Ed.), ISBN: 978-953-307-941-7, InTech, Available from: <http://www.intechopen.com/books/robotic-systems-applications-control-and-programming/robot-handling-fabrics-towards-sewing-using-computational-intelligence>

INTECH

open science | open minds

InTech Europe

University Campus STeP Ri
Slavka Krautzeka 83/A
51000 Rijeka, Croatia
Phone: +385 (51) 770 447
Fax: +385 (51) 686 166
www.intechopen.com

InTech China

Unit 405, Office Block, Hotel Equatorial Shanghai
No.65, Yan An Road (West), Shanghai, 200040, China
中国上海市延安西路65号上海国际贵都大饭店办公楼405单元
Phone: +86-21-62489820
Fax: +86-21-62489821

© 2012 The Author(s). Licensee IntechOpen. This is an open access article distributed under the terms of the [Creative Commons Attribution 3.0 License](#), which permits unrestricted use, distribution, and reproduction in any medium, provided the original work is properly cited.