

# Design of Advanced Digital Systems Based on High-Speed Optical Links

J. Torres, R. García, J. Soret, J. Martos, G. Martínez, C. Reig and X. Román  
*Department of Electronic Engineering, University of Valencia, Valencia  
Spain*

## 1. Introduction

Optical fiber links offer very important benefits as EMI immunity, low losses, high bandwidth, etc, so an increasing number of communication applications are being developed and deployed. At both sides of these optical links, the optical data signal has to be converted to (or from) the electronic domain. The processing of such a high speed optical signals is not straightforward in most cases, and special considerations need to be taken into account for a proper electronic design.

In this chapter the main considerations for the design of digital electronic systems based on optical links are going to be presented. In the first section, the optical fiber links components are described, emphasizing the main advantages of optical links for digital data transmission and discussing how high speed optical links are handled in the electronic domain.

In the second section, the fundamentals of Printed Circuit Board (PCB) design will be reviewed, including trace design and routing, multilayer PCBs, electromagnetic interferences and clock signal management.

The pre and post-layout studies required for a proper design will be described in the third section, illustrating the explanation with some considerations about real designs for electronic experiments using high speed optical links.

## 2. High speed optical link components

In this section the main components of high-speed optical links are identified and described. These components are, from optical to electronic domain, fiber optic as transmission medium, high-speed optical transceivers, electronic serializers/deserializers and digital signal processors, typically Field Programmable Gate Arrays (FPGAs). The main characteristics of each component will be identified, and their impact on the total system will be discussed.

### 2.1 Optical fiber link

The main advantages of optical fiber data links are those inherited from the optical nature of the transmission medium. These advantages and drawbacks of optical fibers for data communication are summarized in Table 1.

Advantages	Drawbacks
Immunity to EMI Free from electrical short-circuits and ground loops. Do not produce sparks. Suitable for explosive environment Secure from external monitoring Low loss, can reach large distances without signal regeneration. Large bandwidth, multiplexing capability Small size and light weight Inexpensive	Unsuitable for electrical power transmission Fragile when handling Not easy to reconnect when broken

Table 1. Advantages and drawbacks of optical fiber for data communication.

From the perspective of high speed digital data transmission systems, the immunity to electromagnetic interferences (EMI) is greatly appreciated. In modern electronic systems it is often necessary to run bundles of wires over considerable distances. These wires can act as antennas, so the electromagnetic fields surrounding the wires can generate by induction undesired electrical signal that degrades the transmitted data information. These electromagnetic fields may be, for instance, stray fields from adjacent wires, radio waves present in the environment, or even gamma radiation released during high energy nuclear experiments. Optical fibers have inherent immunity to most forms of EMI, since no metallic wires are present. So, the optical fiber links ability of operating under severe EMI conditions is extremely important for a great number of applications, especially in defense, health and telecommunication sectors.

The second most important advantage of optical fiber links for high speed data transmission is their extremely low-losses (0.2 dB/Km @ 1550 nm) and their very high bandwidth. Moreover, these low losses are relatively independent of frequency, while those of competitive high speed data links increase rapidly with frequency. New generation of Wavelength Division Multiplexing (WDM) systems operating at 40 Gbps per channel can reach more than 2 Tbps along distances longer than 1000 Km without signal regeneration. However, WDM technology and optical equipment in C-band (1550 nm) is relatively expensive, and optical transceivers typically used in digital data transmission electronic systems offer much lower data rates, up to 10 GHz, and a reach of a few hundreds of meters.

## 2.2 Optical transceivers

Optical transceivers are the interfaces between optic and electronic worlds. They perform the optical data transmission and reception, so they integrate a semiconductor laser, an optical photo-detector, an optical modulator, and all the required electronic circuitry for proper signal conditioning, as the laser driver, a limiting amplifier for reception, etc. They can work at different wavelengths (typically 850 nm or 1330 nm) depending on the kind of optic fiber used in the high speed optical data link. In Figure 1 it is shown a commercial Small Form Factor (SFF) LC Optical Transceiver from CS Electronics. This optical transceiver works up to 1.25 Gbps at a wavelength of 850 nm over multimode fiber, and can reach 550 meters without optical regeneration.

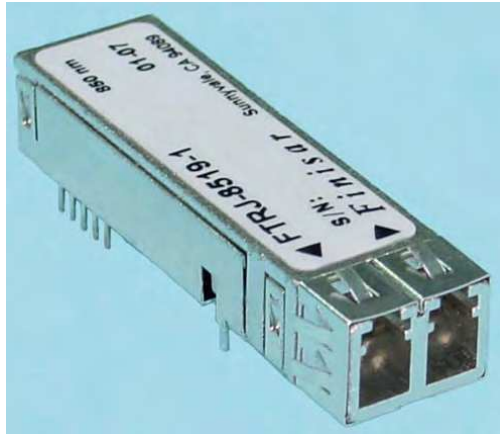

Fig. 1. Image of a comercial SFF optical transceiver.

In order to achieve faster switching and to increase immunity to EMI, crosstalk and noise, high-speed data links work over differential signals. In the case of high speed optical data links, both the electrical input and output signals are typically LVPECL signals (Low-voltage positive emitter-coupled logic). LVPECL is a power optimized version of PECL (uses 3.3 V instead of 5V supply), and both are differential signalling systems mainly used in high speed and clock distribution systems. This technology achieve high speed data rates by using an overdriven BJT differential amplifier with single-ended input, whose emitter current is limited to avoid the slow saturation region of the transistor operation. In Figure 2, a block diagram of a generic optical transceiver is shown.

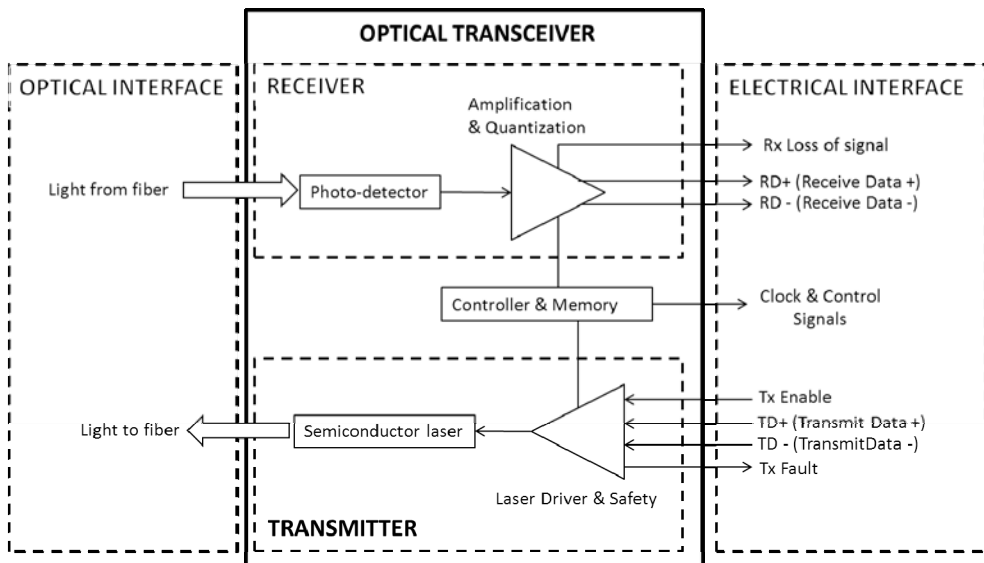

Fig. 2. Transceiver functional diagram.

### 2.3 Electronic components for signal conditioning

As mentioned before, optical links can reach quite high data rates, up to 10 Gbps, that can not be easily handled by the electronic circuitry. Usually, the serial data received by the optical data link is split into several electronic data channels, each of them working at a lower data rate, so they can be properly processed by the electronic components and devices. When transmitting, several electronic data channels are combined onto a single data channel at a high data rate and then is optically transmitted. This aggregation/disaggregation process is performed by electronic serializer/deserializer devices. A serializer receives data information from  $N$  inputs at a given data rate and combine them into a single data channel at a data rate  $N$  times faster. When working as deserializer the process is the opposite. The deserializer receives a single data chunk and breaks it into  $N$  data channels at a data rate  $N$  times slower. So the PCB and the electronic circuitry do not have to operate at the high data rates provided by the optical link.

To serialize data at high speeds, the serial clock rate must be an exact multiple of the clock for the parallel data, so most of electronic designs for high speed optical links use a PLL to multiply a reference clock running at the desired parallel rate to the required serial rate. Moreover, when serial data are received, the optical transceiver must use the same serial clock that serialized the data to deserialize it. At high line rates, providing the serial clock with a separate wire is very impractical because even the slightest difference in length between the data line and the clock line can cause significant clock skew. Instead, optical transceivers recover the clock signal from the data directly, using transitions in the data to adjust the rate of their local serial clock so it is locked to the rate used by the other optical transceiver. Systems using Clock Data Recovery (CDR) can operate over much longer distances at higher speeds than their non-CDR counterparts. However, if transmitted data has too few transitions, the receiving optical transceiver can be unable to apply CDR techniques, so the electronic implementation of encoding schemes is required, as 8B/10B, in which each octet of data is mapped to a 10 bit sequence, or 64B/66B, in which data are grouped into sets of 64 bits, scrambled, then prepended with a 2 bit header.

Additionally, most systems require some form of error detection and correction, as encoding-based error detection or Cyclic Redundancy Checks (CRCs). All this electronic signal conditioning hardware requires quite complex design tasks in order to properly connect the data received/transmitted by the high speed optical link and the processing unit. A simplified block diagram of an optical data link is shown in the figure below.

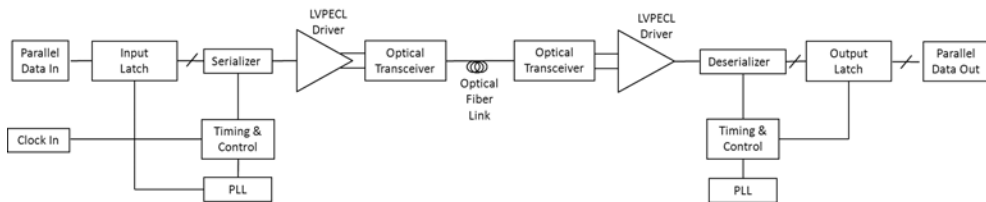

Fig. 3. Optical data link electronic blocks.

### 2.4 High speed digital data processing

The information carried by the data signals has to be generated and processed. To handle the huge amount of information transmitted by the high speed optical links parallel

processing is required, so FPGAs are used. A FPGA is an integrated circuit designed to be configured by the designer after manufacturing. FPGAs contain programmable logic components called "logic blocks", and a hierarchy of reconfigurable interconnects that allow the blocks to be "wired together", so many logic gates that can be inter-wired in many different configurations. Logic blocks can be configured to perform a huge amount of complex combinational functions. In most FPGAs, the logic blocks also include memory elements, which may be simple flip-flops or more complete blocks of memory.

A FPGA can also include multipliers, so it can be used for digital signal processing functions. Once the FPGA internal circuits have been hardware interconnected to perform a given functionality, the FPGA can perform parallel data processing at a very high speed, in the order of hundreds of MHz. So that is the reason for its wide use together with high speed data links.

Moreover, very impressive advances have been done in recent years related to FPGAs configuration capabilities. Nowadays it is possible to implement inside the FPGA a great variety of electronic building blocks and peripherals, for instance, 32-bits hardware microprocessors as MicroBlaze® from Xilinx. These advances include the implementation of MultiGigabit Transceivers (MGT) inside the FPGA. These transceivers performs all the electronic signal conditioning described in section 2.3, so the optical transceiver can be connected almost directly to the FPGA input/output ports. These MGTs manage all the aspects of communication with optical transceivers, as signal integrity, serialization/deserialization, terminations and coupling, line rates, encoding, clock correction, latencies, etc. So the FPGA embedded MGTs are a great improvement for high speed optical links because they simplify the electronic hardware design and reduce the project development costs. Figure 4 shows a building block of the typical MGT functionality.

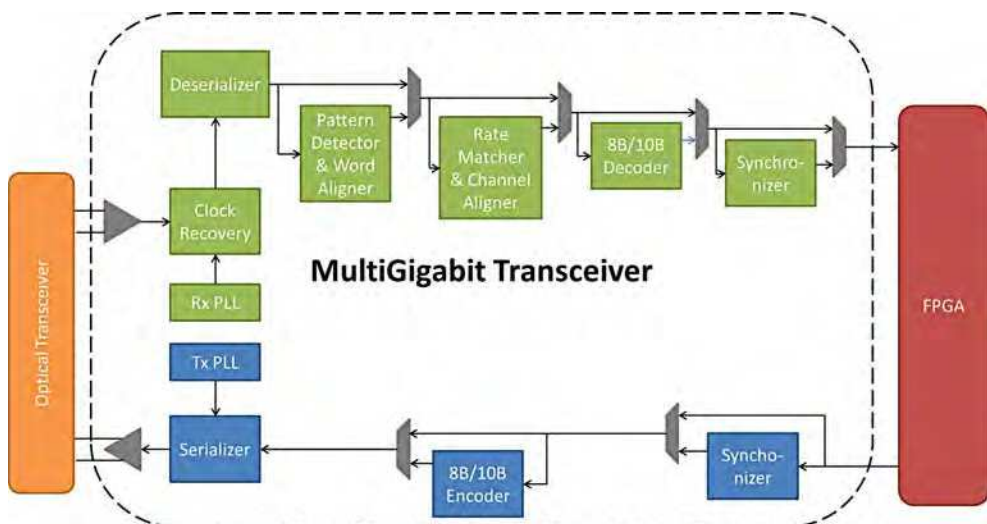

Fig. 4. MGT building block configuration.

### 3. Optical links design considerations

Optical fiber links are typically used for high-speed data transmissions. In such scenarios, several specific issues need to be taken into account. In this section, the most common problems in high-speed PCB design will be enumerated and briefly described. Some suggestions will be also given in order to minimize them. The key points to be considered are the transmission lines, crosstalk, differential traces, decoupling and power system, EMI, clock signals and other specific considerations.

#### 3.1 Transmission lines

Lossy transmission lines are common on printed circuit boards. Signals travelling at high frequencies through narrow strips are affected by the skin effect and the dielectric losses, producing signal distortion. In a basic model, transmission lines can be described as formed by a network of inductors, capacitors and resistances, as it is shown in Figure 5. At high frequency, these effects appear, causing reflections and attenuations of the signal.

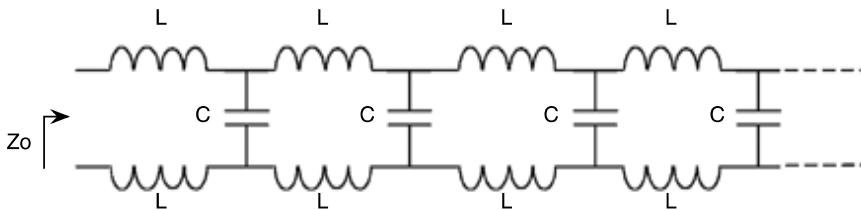

Fig. 5. Distributed parameters transmission line model.

In this sense, the characteristic impedance of a transmission line needs to be introduced as its fundamental parameter. It is defined by the following expression:

$$Z_0 = \sqrt{L/C}$$

In order to reduce the reflections, the characteristic impedance ( $Z_0$ ) of the line should be matched to the source impedance ( $Z_s$ ) as well as to the load impedance ( $Z_L$ ). This matching procedure can be carried out by using several types of matching networks:

- Single Parallel Termination.
- Thevenin Parallel Termination.
- Active Parallel Termination.
- Series-RC Parallel Termination.
- Series Termination.
- Differential Pair Termination.
- On-Chip Termination.
- Diode Termination.

A common problem in high-speed PCB design is the formation of undesired stubs. These stubs are non-terminated transmission line segments that generate impedance mismatching, and then, undesired reflexions. Stubs can appear from single non-terminated lines, pins, unfinished IC's or non-terminated segments acting as antennas, as illustrated in Figure 6. In

order to avoid unexpected stubs, the length or the strips must be reduced at maximum and all the unused pins should be connected to ground or power.

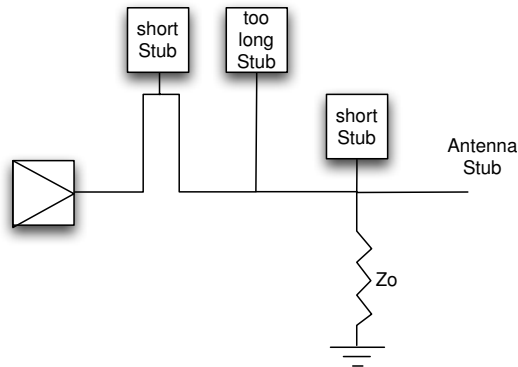

Fig. 6. Stubs examples.

### 3.2 Crosstalk and differential traces

Coupling between signals appears due to induced voltage from one line to another one. The magnetic coupling is produced by the mutual inductance, while the electric coupling is represented by mutual capacitances. This is represented in Figure 7. The undesirable energy coupled between lines is called crosstalk. Switching signals travelling in the same direction and driving the same current are in even mode. Otherwise they are in odd mode.

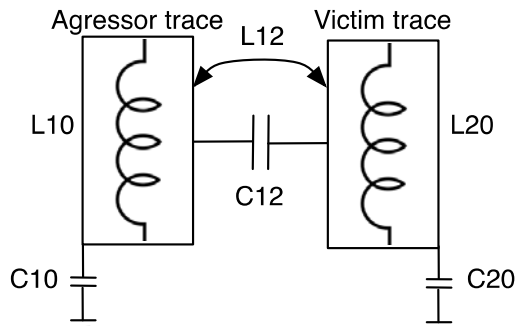

Fig. 7. Crosstalk between traces.

For reducing this effect a number of considerations are listed:

- Use, when possible, strip-lines. They are strips placed between planes, acting as shielding.
- Use, when possible, proper stack-up, by placing the traces as close as possible from their reference planes. This will help to uncoupling nearby signals and will couple it to the reference plane.
- Separate tracks as far as possible. Use the rule: the distance between the middle of traces must be four times the trace width.

- Use terminations to reduce the crosstalk.
- Minimize the signal return loops. If it exists a significant coupling between signals of contiguous layers, both should be orthogonal to each.

Another very important consideration in order to reduce crosstalk is using differential routing techniques (see Figure 8) since, in this way, ground noise related problems are avoided by providing high noise margins. In addition, the inductance influences are cancelled. Due the differential signals have the same length and they are opposite, there is not signal return through ground. Switching times can be more accurate if these kinds of signals are used instead of single-ended signal.

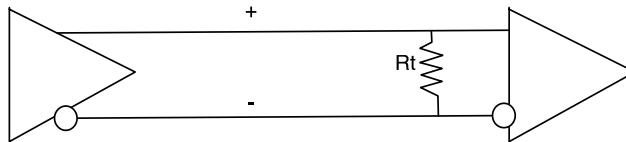

Fig. 8. Differential signal.

The key point when dealing with this kind of signals is setting the lines with the same distance in order to keep the signals in phase. Otherwise, the power integrity should be affected. It is possible to give a number of recommendations regarding the design of this kind of lines:

- The traces must have the same length. This is because the delay must be minimum. Otherwise, it could generate serious EMI problems due to the appearance of common mode currents. Another problem is caused by the induced current on the plane, acting as crosstalk.
- Keep the loop area minimum. The traces must be routed as close as possible, even eliminating the planes that are below of differential traces and removing induced loops.
- When dealing with differential traces very close to each other, terminations for reducing coupling should be used. For selecting the appropriate termination, impedance calculations can be required.
- The separation between lines must be constant along them. Try to avoid layer changes, so routing in the same layer, and try to avoid using traces between two lines forming a differential pair.
- Try to avoid the use of vias. They introduce losses and an impedance steps. If we need to use them, in transitions, place them next to each other for maintaining the differential impedance ratio.

### 3.3 Decoupling and power systems

It is indispensable to know which is the current return of a high-speed signal. An effect, called ground bounce, will produce to cause a reference level increase. The effect is caused by the short switching times. They cause high transients current and discharge load capacitances. Load capacitance, inductance of the connectors and the number of switching are the predominant factors to increase the effect. For this reason, capacitors should be placed near devices and parasitic inductances that contribute to the ground bounce. This effect is shown in Figure 9.



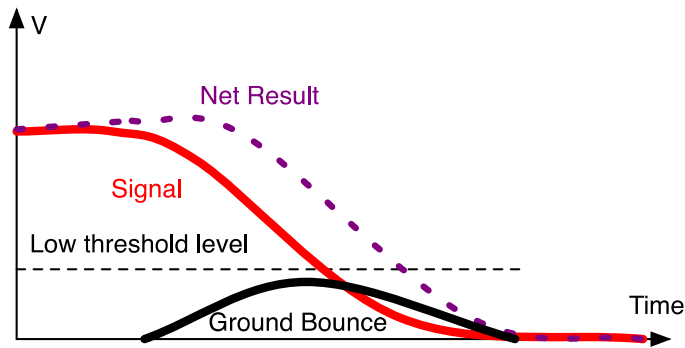

Fig. 9. Ground bounce effect over signal.

The uncoupling of power supplies provides benefits on power integrity, signal integrity and highly reduces EMI.

Small capacitors usually display better performance at high frequency regimes, but they also usually display higher inductances than bigger ones. Each capacitor has a recommended frequency band usage, described by its equivalent series resistance (ESR) and the quality factor (Q). To reduce its inductance, the capacitor should be placed as close as possible to the power source. It is recommended to connect it directly to the power and reference plane, avoiding any surrounding traces around it. The distance should not be more than quarter of wavelength.

In the frequency response of a capacitor there is a point called resonance point where the value of the impedance of the equivalent LC circuit is zero, as shown in Figure 10. From this point, the capacitor behaves like an inductor rather than a capacitor. The use of multiple capacitors in parallel does not change the resonance frequency but increases the capacitance effect, so reducing the individual inductance and the ESR.

The impedance response in power systems can be improved by the increasing of the number of capacitors and by considering capacitors with moderate ESR.

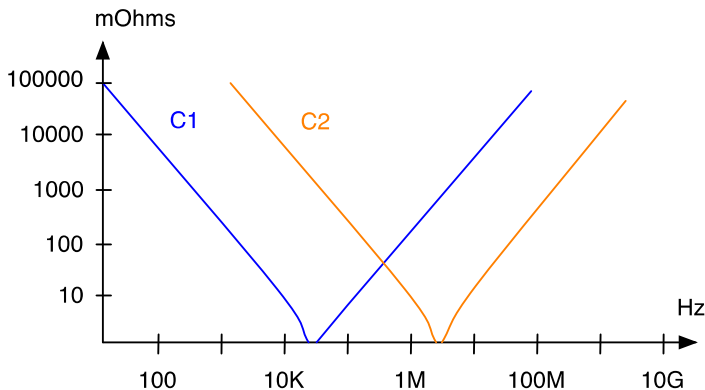

Fig. 10. Frequency response of the inductance of capacitors in parallel.

Other considerations that we should follow are:

- Eliminate connectors when possible.
- Use multilayer PCBs.
- Connect the capacitor pad in the plane through big vias to minimize the inductance and so helping the current flow.
- The traces travelling from power pins to planes must be wide and short in order to reduce the serial inductance, so decreasing the ground bounce.
- Connect each ground pin or via in the plane individually.
- The signal returns that go through connectors must have ground connections with the same potential. For this, the use of several returns (ground) for each one or two signals is necessary.
- Using antipads reduces coupling between the connector and the ground or power plane.

For isolating the high frequency noise, local filtering is recommended. Ferrites, requiring a big size capacitor to keep the output impedance in a reasonable level, are usually used.

Another point is which considerations take into account when using analog and digital sections in power systems. Variations in voltage gradients can be produced, due to the high frequency of returning currents or to the current that flows through the planes from regulated sources. These variations produce the charge and discharge of the bypass and planar capacitors of the circuit, therefore generating noise. To avoid the noise generated for another circuit sections different power supplies distributed in different regions of the circuit can be used. It can be used different voltage power distributed in the same plane. If each power section requires its own distribution plane, then they should have their own reference plane. All reasons to use planes go in the same direction: noise control.

Some of the rules regarding the use of planes are the following:

- Planes must be routed separately, in star. When multiples islands of power supply are routed in the board, they must be connected to a single point through 0-ohm resistors or ferrites. Often, the analog ground is joined to the digital ground, in this way.
- Do not allow sections of analog power to be placed above or below a region of digital plane. The components must be efficiently placed and grouped with their planes without overlap with other circuits (Figure 11).
- Be careful when uncoupling. Do not bypass erroneous references that may cause noise coupling between planes.
- Do not track traces if its current return has a discontinuity or gap. They will have a big loop and EMI problems can appear.
- If the power plane shares analog and digital supply, both sections must be separated. Then, the components should be placed in their respective planes.
- Each high-speed line must be referenced with its contiguous plane, for reducing loop, controlling the impedance and the crosstalk.

The layer stack is very important for reducing loops and having the control of the capacitance between planes as well as having EMI control. A good design is characterized by having each trace referenced to nearby planes and each power supply, providing a capacitance between planes. A good layer stack example is shown in Figure 12.

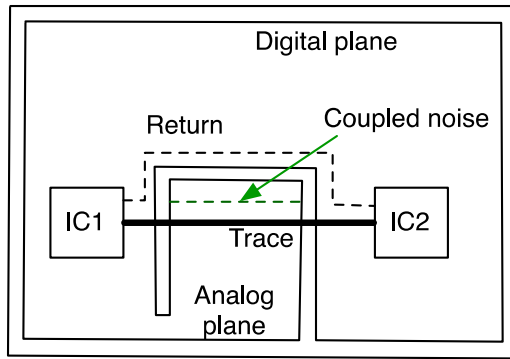

Fig. 11. Trace overlapping a not related plane.

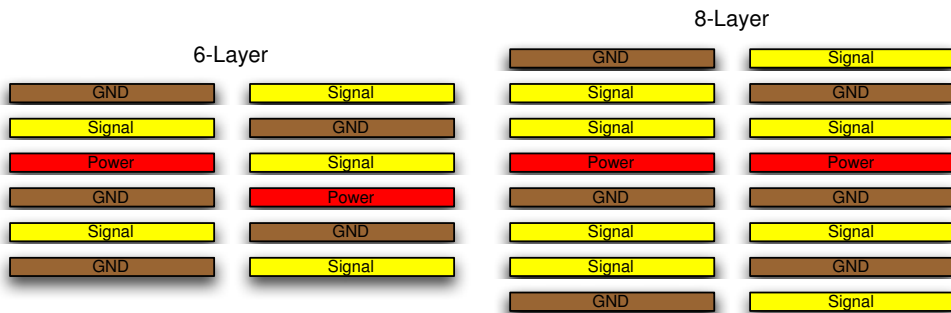

Fig. 12. Good stack layer for 6 and 8 layers.

As it can be seen, it is always preferred a layer stack where the signal layers are placed between two planes. If using many signal layers is necessary, two signal layers can be contiguously placed, although they should be orthogonally routed, in order to avoid couplings.

### 3.4 Electromagnetic Interferences (EMI)

Electromagnetic interferences are directly proportional to the change in current or voltage as a function of the time and the serial inductance of the circuit. PCBs always generate EMI, so a number of considerations for minimizing them should be taken into account.

- Place each signal layer between ground plane and power plane. Inductance is directly proportional to the distance. The shorter distance, the lower inductance.
- Select low inductance components, like surface mount devices (SMD).
- Reduce return paths by using solid ground planes. Keep the signal and the return as close as possible each to other. Remember that current return travels through the minimum impedance path.
- Place capacitors near connectors or devices.
- The use of strip lines adds an extra control on EMI.
- Avoid the use of stubs. They can behave like antennas.

One of the main sources of EMI is the current loop. The other is common mode problems. The differential mode is the mode where the signals travel forming a path and a return in opposite direction. When signals travel in the same direction, both signal and return, is called common mode. This occurs because the ground is not a perfect driver and there is an undesired associated inductance. This effect is illustrated in Figure 13.

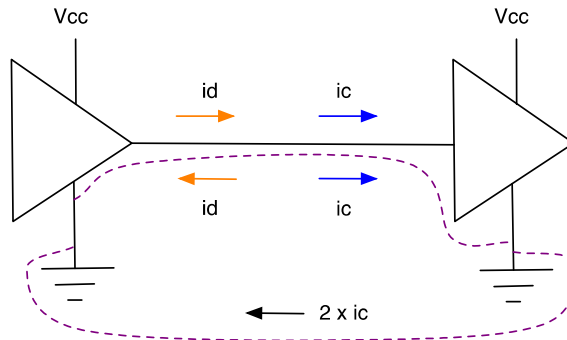

Fig. 13. Common and differential mode.

The main considerations in order to reduce this effect are the following:

- Keep a solid reference and continuous plane for each line. Trace the critical lines as striplines.
- Reduce presence of stubs.
- Ensure that exists a good capacitive coupling between planes.

### 3.5 Clock transmission line

We have mentioned differential lines but we have not introduced single-ended lines connecting a source with load or receiver. They are used in point-to-point routing, signal clock routing, low-speed lines and non-critical I/O lines. Signal clock routing is the most remarkable point in single-ended lines. The following considerations are given to improve signal integrity in clock signals:

- Keep lines as straight as possible. Use rounded shapes instead of sharp angled ones.
- Do not use multiple signal layers for clock signals.
- Do not use vias in clock lines. They change the impedance and they cause reflexions.
- Place a ground plane next to the outer layer to minimize the noise. If you use inner layers for routing a clock trace, form a sandwich with both layers.
- Use terminations to minimize reflexions.
- Use point-to-point traces.

The clock signals can be routed in several ways. If a daisy chain routing is used, undesired stubs or short traces can appear, so degrading the signal quality and producing reflexions. When considering a star routing, the clock signal arrives to all devices at the same time, so lines must have the same length. Each load must be identical for minimizing signal integrity problems. To design traces with the same length, serpentine techniques for time adjusting are used. Several types of clock signal routing are illustrated in Figure 14.

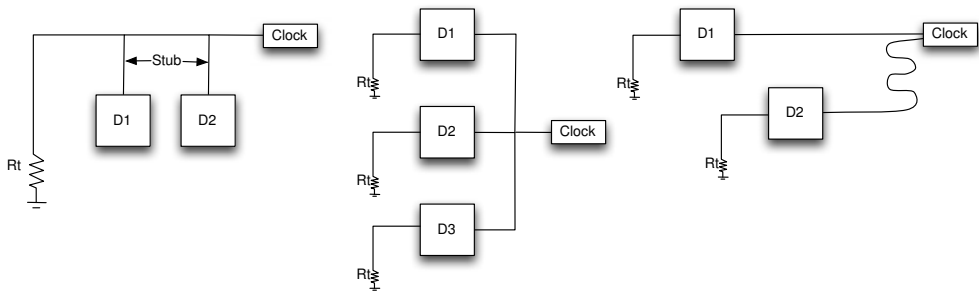

Fig. 14. Types of clock signal routing.

### 3.6 Other considerations

In high-speed designs other considerations are taken into account, depending on the amount of information needed to be sent.

For example, at data rates of 622 Mbps and higher, the skin effect is extremely important. This could cause signal attenuations over long distances. The result is a low pass filter with attenuation, which increases with frequency. For this reason, the traces should be wider.

On the other hand, connectors and vias cause impedance discontinuities. In order to reduce them, specific connectors with shielding features with many ground connections must be used.

High-performance cables are also very important to have a good bandwidth and for minimizing attenuation losses.

When working at 2.5 Gbps and beyond, the problems become substantially more difficult to eliminate. There are many copper and dielectric losses. It is needed to pay attention to every consideration for PCB and layout design. A backplane thickness of less than 0.200 inches gives the best result. Vias used for interconnection between layers create line discontinuities. These routed layers should be as few as possible and thus limiting the number of vias, so the vias are shorter, minimizing line discontinuities. Buried vias can be used to reduce this problem in thicker boards.

The material used in boards is very important. FR4 dielectric commonly used has significant losses above 2 Gbps. For this reason, low-loss dielectric PCB material can be used such as Rogers 4350, GETEK or ARLON.

## 4. Signal integrity studies

Digital system design has therefore moved deep into the Multi-GHz range, with signal rise and fall-times of the order of 100ps or less. It is a well-known fact that Signal Integrity (SI) simulations become necessary when system designs break the 50-100MHz barrier, and are virtually mandatory in the GHz range. SI simulations are used to ensure the quality and accurate timing of electrical signals. The benefits of SI analysis early in the design cycle are well established, as it allows the identification and resolution of SI problems like overshoot, ringing, crosstalk, delay mismatches, etc. before the first prototype is built.

## 4.1 Pre-layout studies

The pre-layout simulations are required at the earliest stages of the PCB design. In this stage the designer evaluates several topologies and selects the one that fulfils all the specifications such as size, component number and performance. In addition, the results of these simulations help to set crucial parameters for the transmission structure, such as trace width, trace spacing, maximum trace length, and critical component placement. It is important to understand these simulations are intended for selecting the components and topologies as well as for fine tuning of the signal path. The results analysis is used to set the rules that will be incorporated into the layout.

As an example, and taking into account the design considerations described in the previous section, a real design is going to be studied. The main elements in this design are:

- SFP Optical Connector with two receiver channels (1)
- Transmitter/Receiver Chip Set (2)
- FPGA (3)

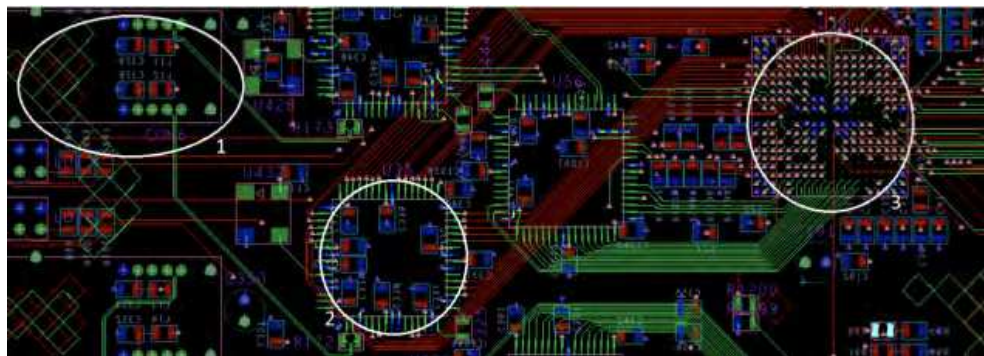

Fig. 15. Elements of Advanced Digital Systems based on High-Speed Optical Links in PCB.

The optical connector has a differential output (LVPECL), routed to the entrance of Transmitter/Receiver Chip Set. These transmission lines are the most critical of the study because is a point-to-point serial data transmission with a very high bit rate.

Another point to be taken into account is the connection between data acquired in the Transmitter/Receiver Chip Set and the FPGA. In this case, the importance of the study is not based in data frequency. We must avoid the data bus crosstalk.

### 4.1.1 Differential lines

This signal has a critical jitter and the topology, geometry, length, and termination impedance must be carefully studied. In this case, it is observed the differential line without being routed.



Fig. 16. Unrouted differential lines.

The topology is extracted according to the manufacturer's datasheet optical connector.

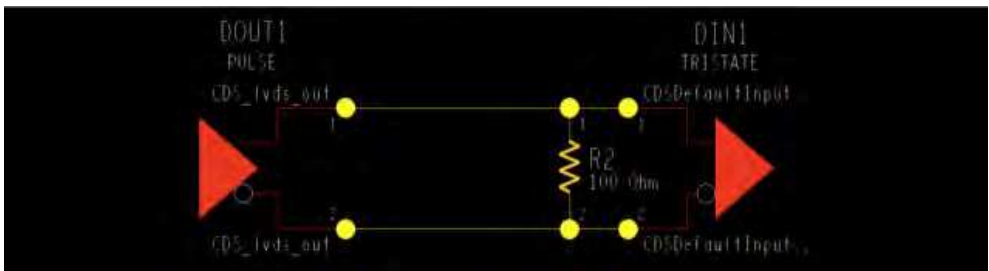

Fig. 17. Extracted topology.

An ideal study without transmission line is performed. The simulation for this case is:

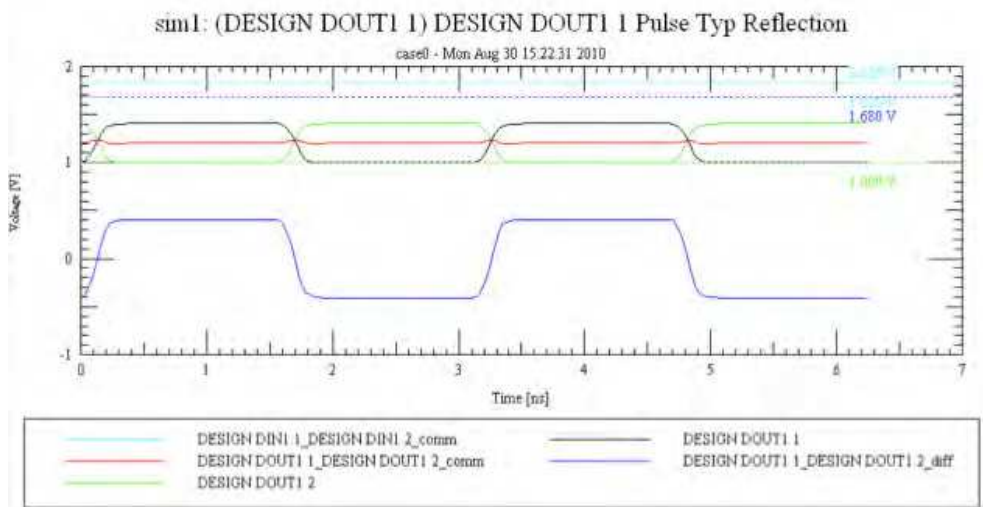

Fig. 18. Waveforms for differential lines.

In black and green color RX+ and RX- signals are observed and in blue color the resulting differential signal is presented. The voltage values obtained are the same that the manufacturer recommendations.

The next step, seeing the topology is correct, it would add a transmission line and observe the maximum length that could have the routing. In the next section another types of line will be studied.

### 4.1.2 Parallel data bus

In this case, the connection between the transmitter/receiver chip set and the FPGA is studied. Its speed of transmission is not comparable with that of the differential line. Even so, the maximum length must be checked and a termination may be needed.

First, a study of a single line to detect maximum length and optimal termination has to be performed. The study was performed for a bus of 32 lines at 80 MHz.

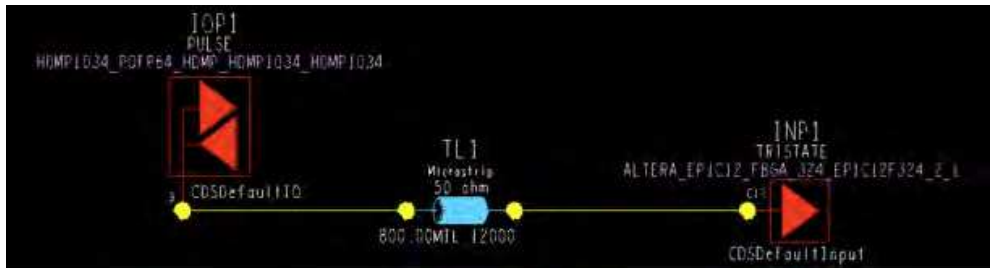

Fig. 19. Topology of single-ended line.

The waveforms for each length (800, 5000, 9000 y 12000 mils) are as follows:

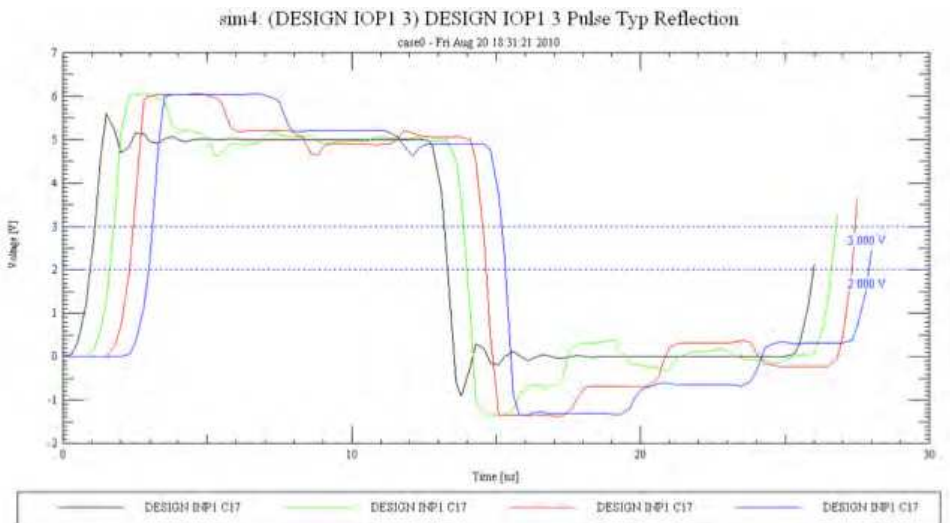

Fig. 20. Waveform for single-ended line.



The waveforms 800, 5000, 9000 y 12000 mils in black, green, red and blue provide a delay to the length, which increases to approximately 2.14 ns in the worst case. This shows a mismatched line. Also the waveforms will degrade depending on the length of the track due to the increasing influence of the reflections, since an overshoot and ringing growing.

The worst case above (12000 mils) but with a termination is now studied. The topology is:

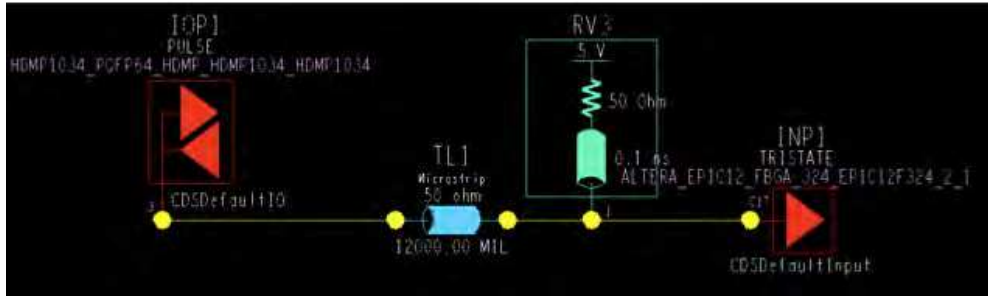

Fig. 21. Topology of single-ended line with active termination.

The results are:

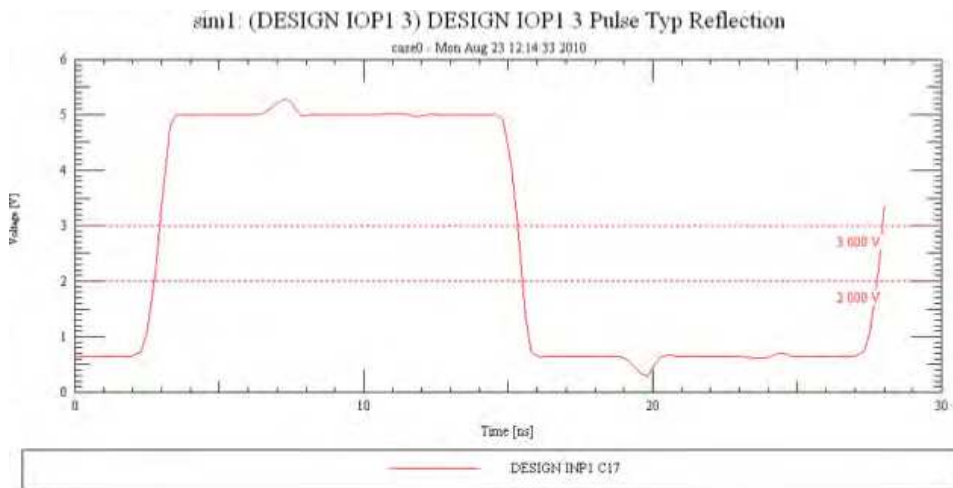

Fig. 22. Waveform of single-ended line with active termination.

Which greatly improves the previous case:

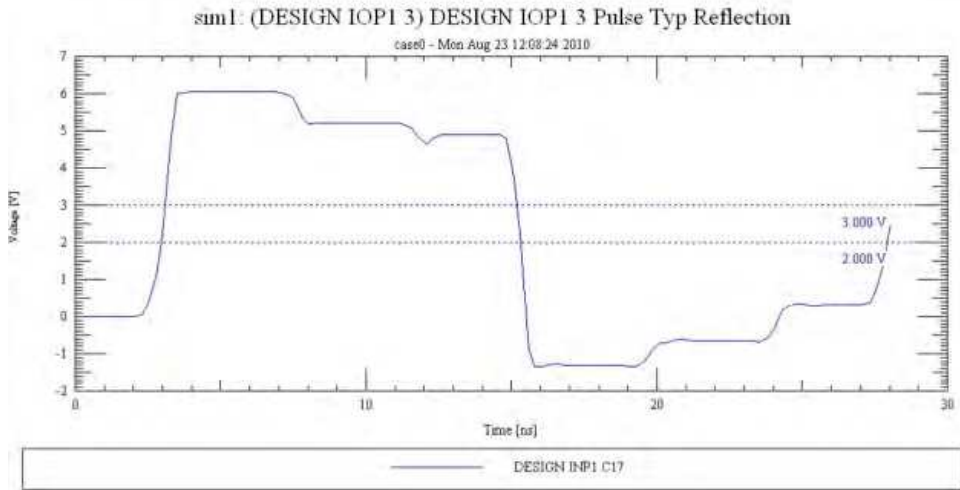

Fig. 23. Waveform of single-ended line without termination.

Working with a data bus is essential to examine the crosstalk between the lines. The topology studied is as follows:

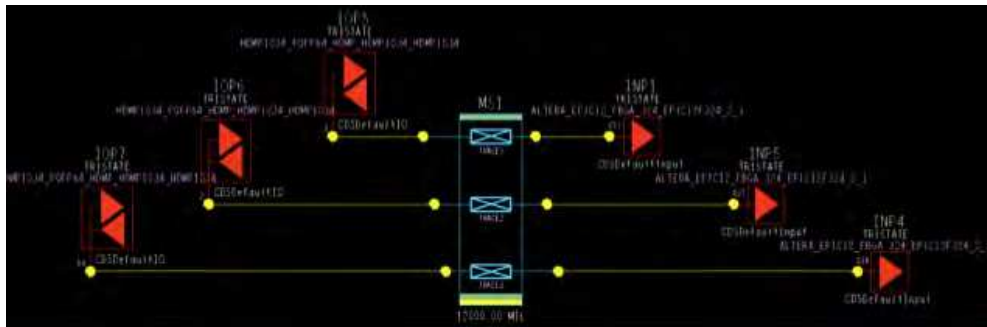

Fig. 24. Topology of three parallel lines.

Where there are three bus lines, taking the top and bottom as aggressors and the middle line as victim.

The results for high steady state are:

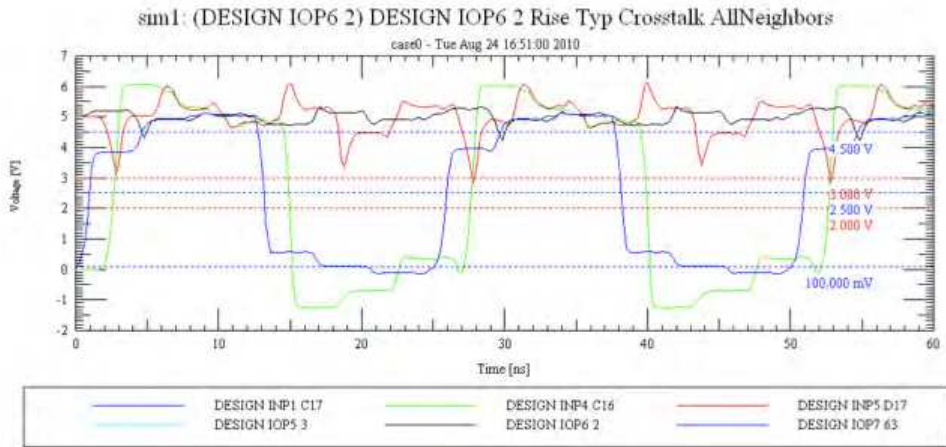

Fig. 25. Waveforms of three parallel lines.

In blue and green color, we have waveforms of the FPGA inputs, that correspond to the aggressor signal. The red one is the receiver input that flowing by the victim trace, and the black one is the output driver of the victim trace. In this case a crosstalk about 2149mV is obtained and the simulation does not pass the test (the victim signal is in an undefined logic state, below 3V).

In the previous section is commented that the solution is adapting the transmission lines using terminations. If an active termination is added to the lines and then the simulation is made in each line, the result is as follows.

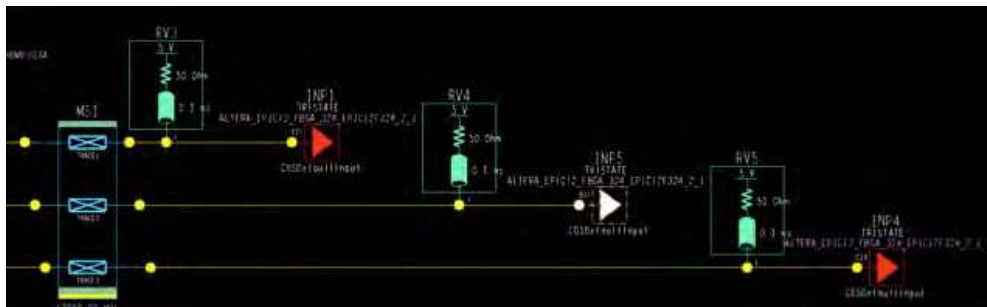

Fig. 26. Topology of three parallel lines with active termination.

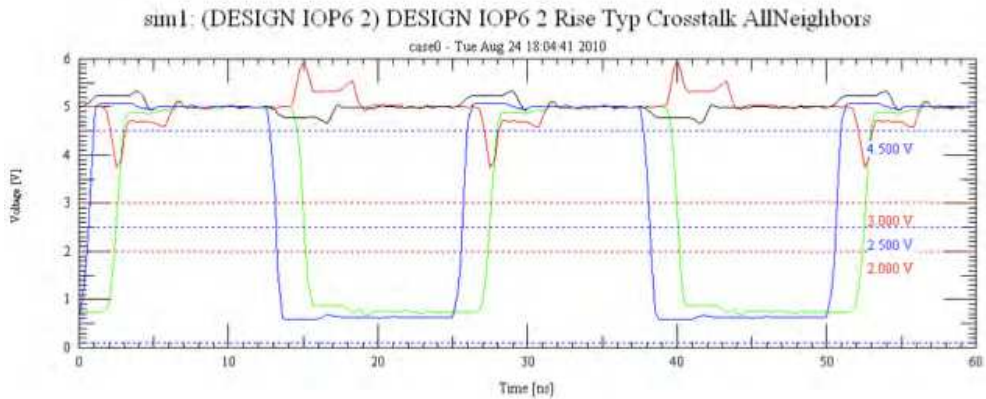

Fig. 27. Waveforms of three parallel lines with active termination (high level).

It can be observed a clear improvement in the crosstalk level, keeping the victim signal inside the permitted high level range. However, at low level it is shown a crosstalk of 1421 that causes the victim signal introduces in the forbidden region for low level, and this can cause errors.

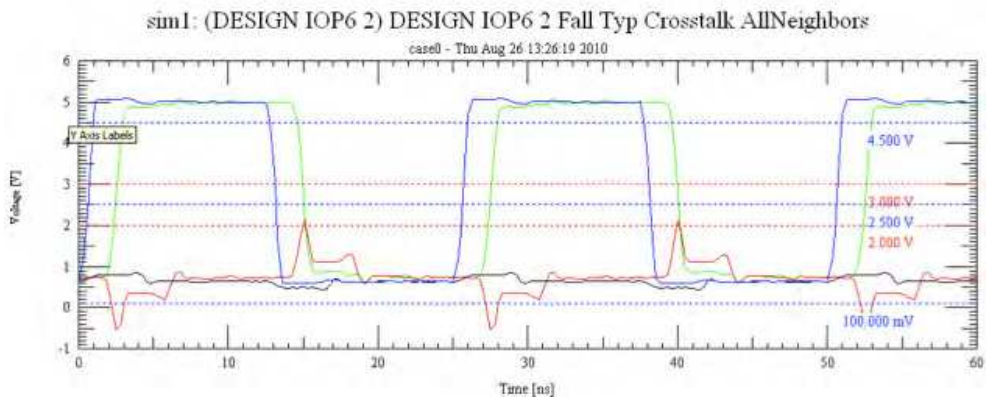

Fig. 28. Waveforms of three parallel lines with active termination (low level).

Then, the initial solution of placing an active termination is not suitable. As theory says, we should test a serial termination and check what happen.

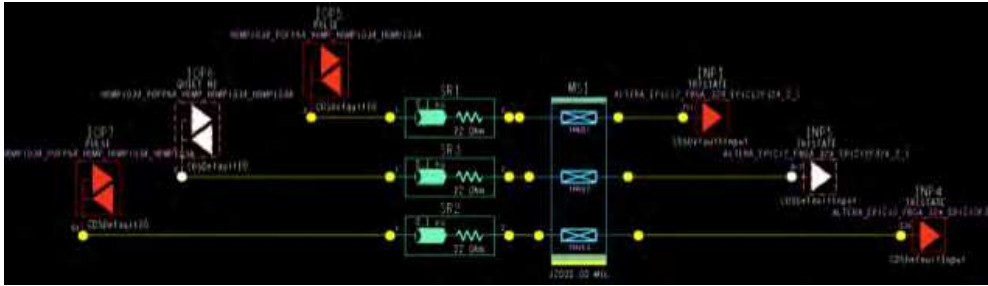

Fig. 29. Topology of three parallel lines with serial termination.

In this case, crosstalk level keeps the victim signal within the permissible limits either in/for high level (figure 30) or low level (figure 31). The values are 1365 mV for high level and 1514 mV for low level.

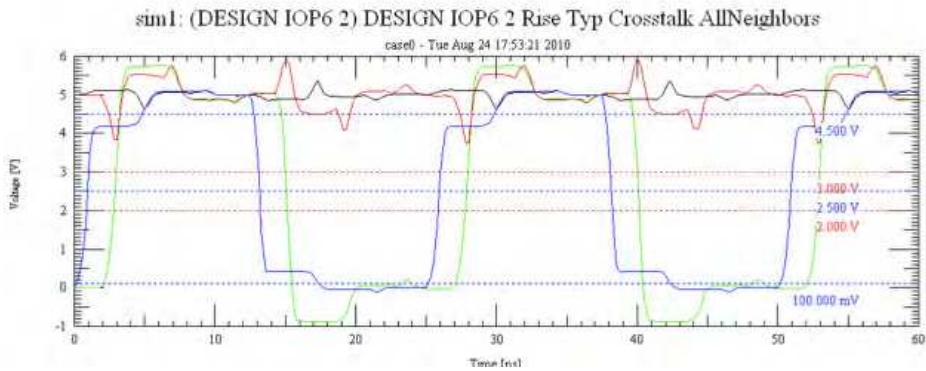

Fig. 30. Waveforms of three parallel lines with serial termination (high level).

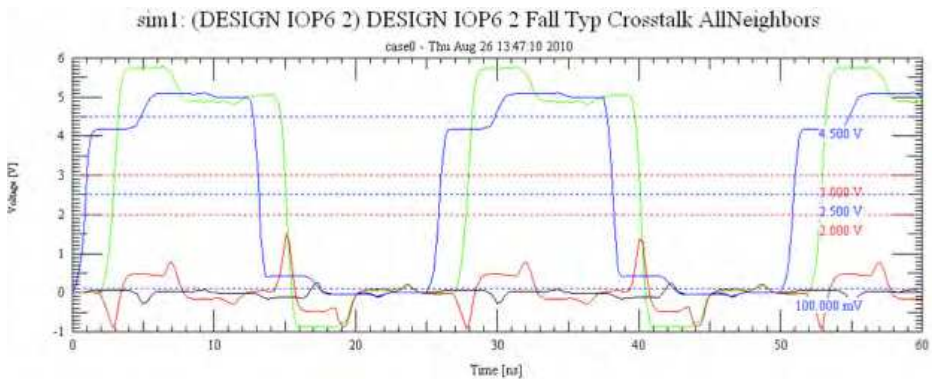

Fig. 31. Waveforms of three parallel lines with serial termination (low level).

### 4.2 Post-layout studies

When the layout is complete, a post-layout simulation is performed on the critical sections of the board to ensure there are no major signal integrity problems. Based on the results of the post-layout simulation, any changes required are incorporated in the layout and the layout is released to the fabrication house for board manufacturing. The post-layout simulation process requires the layout of all active layers on the board as well as the physical properties of the dielectric and metal layers. The post-layout simulations use the physical properties supplied by the fabrication house that may differ from those published.

#### 4.2.1 Differential lines

Taking the pre-layout studies conducted on the differential lines and after to route them with the defined conditions, we extract the real topology that will be sent to the manufacturer for verification.

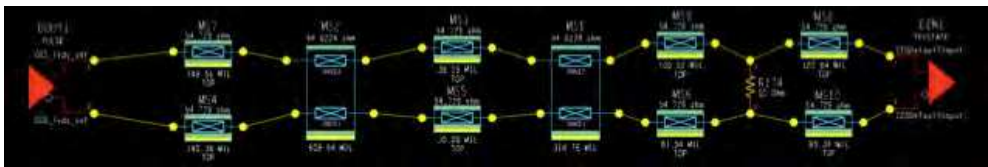

Fig. 32. Real topology of differential lines.

We can see that actual results match those obtained in the ideal simulation (Figure 18):

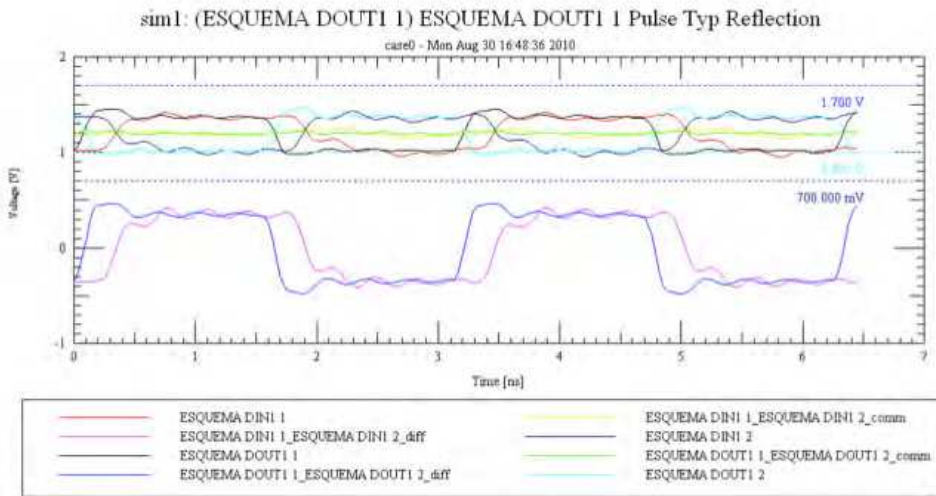

Fig. 33. Real waveforms of differential lines.



### 4.2.2 Parallel data bus

In this case, as in the above, we extract the real topology. We studied a serial termination in bus line.

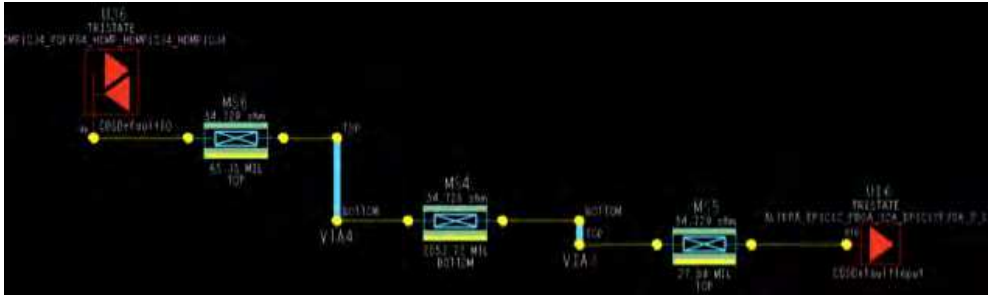

Fig. 34. Real topology of parallel data bus.

The results are as expected, we see that the data sent between the transmitter/receiver chip set and the FPGA function properly at the selected frequency and the distance routed.

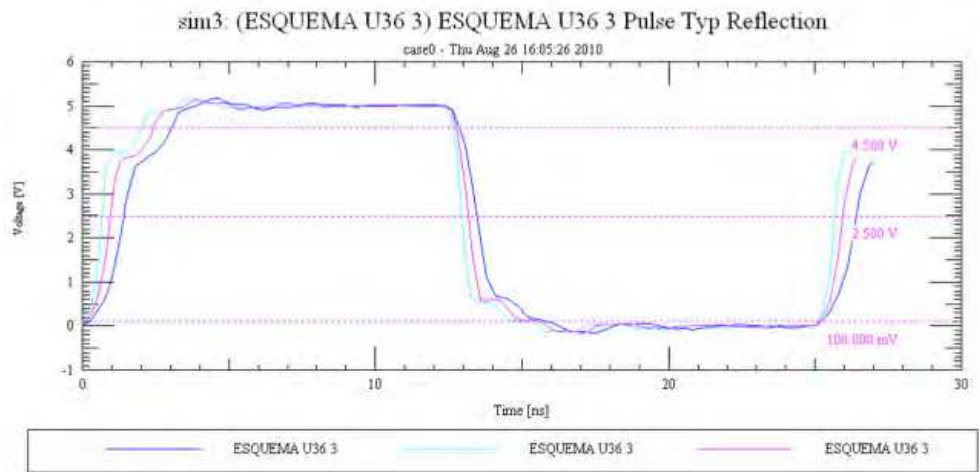

Fig. 35. Real waveforms of parallel data bus.

## 5. Conclusions

The wide range of applications of optical fibers has been continuously supported by their friendly integration with classic electronics. Being the optical transceiver the key element in such hybrid systems, their design is not straightforward, and need to take into account a good number of particularities.

In this chapter the main handicaps when developing electronics specifically for high-speed fiber optic communications have been highlighted. Some of these issues fully lay in the field

of electronic engineering. Other aspects, and due to the high frequency involved in such systems, need some additional analysis. In this sense, the electromagnetic theory, as used for wave propagation in dielectric materials, has to be applied to the electric transmission lines present in some cases.

Being experiments the common analysis tools in hybrid opto-electronic systems, some simulation tools can be sometimes used for fixing specific problems like cross-talking. These numerical tools are of particular interest for proper routing design in PCBs.

After all, these systems have demonstrated their applicability in a huge number of scenarios including communications, medicine, nuclear research, etc.

## 6. References

- [1] Douglas Brooks, "Signal Integrity Issues and Printed Circuit Board Design", Prentice Hall PTR, 2003. ISBN: 0-131-41884-X
- [2] Stephen C. Thierauf, "High-Speed Circuit Board Signal Integrity", Artech House Inc., 2004, ISBN: 1-58053-131-8
- [3] Mark. I. Montrose, "Printed Circuit Board Design Techniques for EMC", Wiley-Interscience-IEEE, 2000, ISBN: 0-7803-5376-5
- [4] Lattice Semi, "High-Speed PCB Design Considerations", Technical Note TB1033, 2011.
- [5] Altera, "High-Speed Board Layout Guidelines", Application Note 224, 2009.
- [6] Sackinger, E., "Broadband circuits for optical fiber communication", Wiley, 2005. ISBN: 9780471712336
- [7] Cox, C.H., "Analog optical links: Theory and practice", Cambridge University Press, 2004. ISBN: 0-521-62163-1
- [8] Muller, P., Leblebici, Y., "CMOS Multichannel Single-Chip Receivers for Multi-Gigabit Optical Data Communications (Analog circuits and signal processing)", Springer, 2010. ISBN: 978-90-481-7473-7
- [9] ATLAS Trigger and DAQ steering group, "Trigger and Daq Interfaces with FE systems: Requirement document. Version 2.0", DAQ-NO-103, 1998.
- [10] Dowell, M. Pearce, "ATLAS front-end read-out link requirements", ATLAS internal note, ATLAS-ELEC-1, July 1998
- [11] J. Torres, "Estudio, diseño e implementación del módulo de preprocesado de datos del Sistema Read Out Driver para el calorímetro TileCal del experimento ATLAS/LHC del CERN", Tesis Doctoral, Servicio de Publicaciones de la Universidad de Valencia, Junio 2005.
- [12] J. Torres et al, "Signal integrity studies at optical multiplexer board for tilecal system", 2007 IOP Publishing Ltd and SISSA.
- [13] Lynne Green, "Signal Integrity", IEEE Circuits and Devices, November 1999.
- [14] Jim Lipman, "Models make the difference in high-speed pc-board design", Electronic Design News, 15th April 1999.



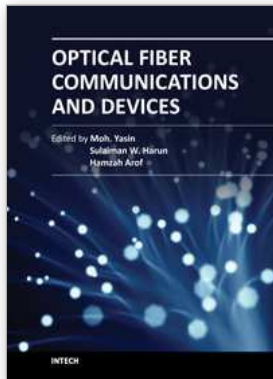

## **Optical Fiber Communications and Devices**

Edited by Dr Moh. Yasin

ISBN 978-953-307-954-7

Hard cover, 380 pages

**Publisher** InTech

**Published online** 01, February, 2012

**Published in print edition** February, 2012

This book is a collection of works dealing with the important technologies and mathematical concepts behind today's optical fiber communications and devices. It features 17 selected topics such as architecture and topologies of optical networks, secure optical communication, PONs, LANs, and WANs and thus provides an overall view of current research trends and technology on these topics. The book compiles worldwide contributions from many prominent universities and research centers, bringing together leading academics and scientists in the field of photonics and optical communications. This compendium is an invaluable reference edited by three scientists with a wide knowledge of the field and the community. Researchers and practitioners working in photonics and optical communications will find this book a valuable resource.

### **How to reference**

In order to correctly reference this scholarly work, feel free to copy and paste the following:

J. Torres, R. García, J. Soret, J. Martos, G. Martínez, C. Reig and X. Román (2012). Design of Advanced Digital Systems Based on High-Speed Optical Links, Optical Fiber Communications and Devices, Dr Moh. Yasin (Ed.), ISBN: 978-953-307-954-7, InTech, Available from: <http://www.intechopen.com/books/optical-fiber-communications-and-devices/design-of-advanced-digital-systems-based-on-high-speed-optical-links>

**INTECH**  
open science | open minds

### **InTech Europe**

University Campus STeP Ri  
Slavka Krautzeka 83/A  
51000 Rijeka, Croatia  
Phone: +385 (51) 770 447  
Fax: +385 (51) 686 166  
[www.intechopen.com](http://www.intechopen.com)

### **InTech China**

Unit 405, Office Block, Hotel Equatorial Shanghai  
No.65, Yan An Road (West), Shanghai, 200040, China  
中国上海市延安西路65号上海国际贵都大饭店办公楼405单元  
Phone: +86-21-62489820  
Fax: +86-21-62489821

© 2012 The Author(s). Licensee IntechOpen. This is an open access article distributed under the terms of the [Creative Commons Attribution 3.0 License](#), which permits unrestricted use, distribution, and reproduction in any medium, provided the original work is properly cited.