

Optical Fiber Birefringence Effects – Sources, Utilization and Methods of Suppression

Petr Drexler and Pavel Fiala

*Department of Theoretical and Experimental Engineering,
Brno University of Technology,
Czech Republic*

1. Introduction

The application area of optical fibers is quite extensive. Telecommunication applications were the primary field of fibers employment. The related area is the utilization of optical fibers for control purposes, which benefits from principal galvanic isolation between the transmitting and receiving part of the system. A minimal sensitivity of light propagation inside the fiber to electromagnetic field of common magnitudes allows use the fiber in systems with high level of electromagnetic disturbance. Regarding the physical aspects of light propagation in fibers, they find utilization possibility in physical quantities sensors. It is possible to modulate the phase and state of polarization of the wave inside fiber optical medium by means of external physical quantity. The interaction is described by electro-optical, magnet-optical and elasto-optical effects.

In order to achieve high data transmission rates in field of telecommunication applications the single-mode fibers are used exclusively. Similarly, single-mode fibers are used in the case of intrinsic fiber optic sensors. Intrinsic fiber optic sensors exploit the fiber itself to external quantity sensing and the fiber serves to signal transmission also. The reason of single-mode fiber utilization is the presence of basic waveguide mode – single wave with single phase and single polarization characteristic.

In spite of the fiber utilization advantages we have to take into account undesirable effects, which are present in real non-ideal optical fiber. In telecommunication and sensor application field the presence of inherent and induced birefringence is crucial. The presence of birefringence may cause an undesirable state of polarization change. In the case of high-speed data transmission on long distances the polarization mode dispersion may occur. Due to this effect the light pulses are broadened. This may result in inter-symbol interference. In the case of sensor application, when the state of polarization is a carrier quantity, the possibility of output characteristic distortion and sensors sensitivity decreasing may occur.

It's advantageous to consider fiber sensor application for purposes of birefringence origin and influence description, since the presence of linear and circular birefringence together is watched often. While the inherent circular birefringence is negligible in common single-mode fibers, the inherent and induced linear birefringence may be present in considerable rate. The inherent linear birefringence is mostly undesirable effect, when we exclude utilization in polarization maintaining fibers. Whereas, the induced linear

birefringence may be utilized for sensing purposes, e.g. for mechanical stress or pressure sensing. Similarly, induced circular birefringence is a principle effect for group of polarimetric sensors, e.g. polarimetric current sensor.

For the suppression of unwanted linear birefringence influence, inherent and induced also, several approaches and methods have been developed and published. They are often based on different principles. However, they differ in view of their properties and suitability for various applications.

The goal of this chapter is to present basic effects, which lead to occurrence of linear and circular birefringence in single-mode fibers. The methods, which may be used in order to suppress unwanted birefringence, will be presented also. Since the main manifestation of birefringence effects is the transformation of the polarization state of transmitted light, a brief recapitulation of basic polarization states and their illustrative visualizations are given. In following subchapters various mechanisms, which induce birefringence will be introduced together with corresponding relations and comprehensible illustrations. In the last descriptive subchapter the most significant methods for unwanted linear birefringence are presented with their properties and references to related literature.

2. Light polarization

The electromagnetic wave polarization represents how varies orientation, pertinently projection magnitude, of electric field component in a plane which is perpendicular to propagation direction. The polarization character of the wave may be described by means of the magnetic field component also. However, the interaction of matter with light wave is done mainly via the electric field component. Then the electric field intensity vector E is used for polarization states description usually. The general polarization state of the wave is the elliptical one. The special cases are the circular birefringence and linear birefringence.

Consider an electromagnetic wave which is described by electric field intensity vector E and which propagates in direction of z axis. The wave may be represented as a superposition of two partial waves with mutually orthogonal linear polarizations and with the same frequency

$$\mathbf{E} = \mathbf{E}_x + \mathbf{E}_y, \quad (1)$$

where xyz is orthogonal coordinate system and E_x, E_y are vectors of electrical field intensity, which are aligned in x axis direction and y axis direction. It should be noted, that we consider the same frequency of both waves in all of the following analysis. In case of linear polarizations the electric field intensity vectors E_x, E_y swing along a straight line. These two vectors may be assigned to two degenerated modes of the single-mode fiber, which is a dielectric circular waveguide. In a lossless medium hold for field components magnitude relations

$$\begin{aligned} E_x(z, t) &= E_{0,x} \cos(kz - \omega t + \phi_x), \\ E_y(z, t) &= E_{0,y} \cos(kz - \omega t + \phi_y), \end{aligned} \quad (2)$$

where $E_{0,x}, E_{0,y}$ are wave amplitudes, ω is angular frequency of the waves, t is time and ϕ_x, ϕ_y are phases of the wave, k is magnitude of the wave vector. Amplitudes ratio of $E_{0,x}$ and $E_{0,y}$ and phase difference $\Delta\phi = \phi_x - \phi_y$ determine the state of the polarization of the resulting wave.

In case when $E_{0,x} = E_{0,y}$ and $\Delta\phi = 0$ the orthogonal waves are in phase with the same amplitude. We obtain a linearly polarized wave by their superposition. Its plane of polarization is in 45° to y axis (or -45° to x axis) as shown in Fig. 1. In Fig. 1 and following figures k represents the wave vector.

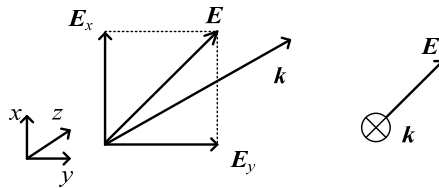

Fig. 1. Superposition of in-phase wave equal in amplitude results in linear polarized wave.

In case when $E_{0,x} = E_{0,y}$ and $\Delta\phi = \pm\pi/2$ the resultant wave has a circular polarization. The end point of E vector of circular polarized wave traces a circle. We differ between right-handed and left-handed circular polarized wave depending on the phase difference $\Delta\phi$ polarity, plus or minus. An illustration of right-handed circular polarized wave is shown in Fig. 2.

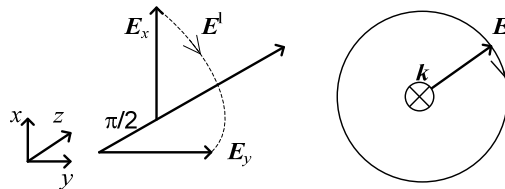

Fig. 2. Right-handed circular polarized wave.

When $\Delta\phi \neq 0, \pm\pi/2$ or $E_{0,x} \neq E_{0,y}$, we obtain an elliptically polarized wave, right-handed or left-handed, in dependence on phase difference $\Delta\phi$ polarity. The end point of E vector of elliptically polarized wave traces an ellipse. The case of left-handed elliptically polarized wave is shown in Fig. 3

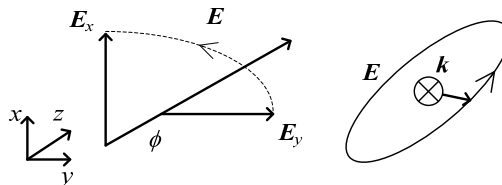

Fig. 3. Left-handed elliptically polarized wave.

As the light wave propagates in homogenous isotropic medium, its velocity remains constant independently on the propagation direction. The propagation velocity is given by the refractive index of the medium n . Refractive index is a ratio of wave velocity in vacuum c and wave phase velocity v_p in the medium, $n = c/v_p$. However, medium may be of

anisotropic character. This means, that the propagation velocity depends on the propagation direction, pertinently polarization. This effect is observed in birefringent materials. In common birefringent materials the optical properties are described by means of index ellipsoid, which is shown in Fig. 4. When linearly polarized wave travels in z axis direction and it is polarized in y axis direction, the wave phase velocity is given by refractive index n_y . When the same wave will be polarized in x axis direction, the phase velocity will be given by refractive index n_x . Since $n_y > n_x$, the first wave will travel slower.

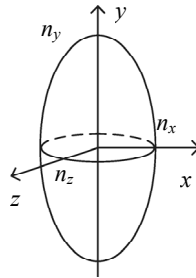

Fig. 4. Index ellipsoid example of birefringent material.

The velocity of wave polarized between y and x axis directions will be given by refractive index, which magnitude lies on ellipse in xy plane. When a light wave travels in birefringent medium of such type described above, it may occur a phase shift between its orthogonal components, which are described by relation (2). This occurs due to different propagation velocities of the components. The resulting state of polarization depends on total phase difference $\Delta\phi$, which is a function of propagation length in birefringent medium also. An example of state of polarization change from linear to elliptical by birefringent medium crossing is shown in Fig. 5.

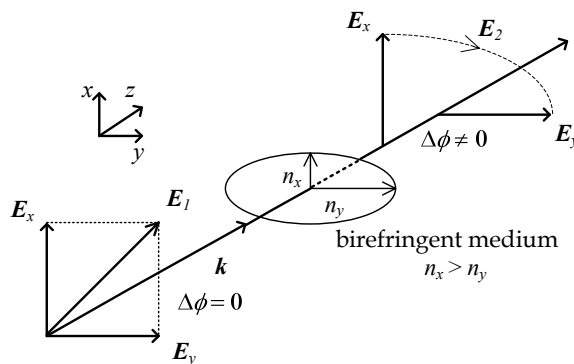

Fig. 5. State of polarization change in birefringent medium.

3. Linear birefringence in optical fiber

In previous section a polarization state of wave has been explained as a superposition result of two partial waves with certain phase shift and certain amplitude ratio. The similar

concept may be used for description of polarization state transformation in single-mode optical fiber. As has been mentioned above, two degenerate modes HE_{11}^x and HE_{11}^y may exist in the fiber with circular core cross-section. The superposition of the two modes, which are orthogonal, results in the wave propagating in the fiber. And, the phase shift of these two modes determines the polarization state of the wave in the fiber. A deeper analysis of mode theory of fibers is out of the scope of this chapter and may be found in relevant literature (Iizuka, 2002).

The phase velocities of two orthogonal modes in the fiber $v_{f,x}$ and $v_{f,y}$ are given by magnitudes of wave numbers β_x and β_y of the modes

$$v_{f,x} = \frac{2\pi f}{\beta_x}, \quad (3)$$

$$v_{f,y} = \frac{2\pi f}{\beta_y}, \quad (4)$$

where f is the frequency of the wave. An ideal single-mode fiber with circular core cross-section along its length, made from homogenous isotropic material, will exhibit the same refractive index n for both of the modes. The wave numbers β_x and β_y will be equal also. The modes will propagate with the same phase speed v_f . At this condition the modes remain degenerate and the resulting polarization state will be preserved. A non-ideal fiber has not a constant circular core cross-section along its length or it exhibits anisotropy due to bending or other mechanical stress. As a consequence, the loss of modes degeneracy occurs. The fiber will behave as a birefringent medium with different refractive indices n_x and n_y and different phase velocities $v_{f,x}$ and $v_{f,y}$. In case of constant core cross-section and constant anisotropy, we can designate β_y as a wave number for a fast mode and β_x for a slow mode. Corresponding axes x and y may be designated as a fast axis and a slow axis of the fiber.

If a linear polarized wave is coupled into the birefringent fiber with gradually varying core cross-section or varying anisotropy, it is not possible to designate one mode as a fast one and second as a slow one. The mode phase shift $\Delta\phi$, which determines the output polarization state, is dependent on average wave number magnitudes and on the fiber length

$$\Delta\phi = (\overline{\beta_x} - \overline{\beta_y})l_v. \quad (5)$$

The output polarization state will not be stable, when one would manipulate with the fiber or when the ambient temperature fluctuates. Since the wave number will be changing. This fact complicates the utilization of single-mode fibers in application with defined polarization state, as the fiber lasers or fiber sensors. Further, photodetectors, which are used in the field of fiber optic telecommunication, are not sensitive to polarization state. However, owing to the fiber birefringence, the phase shift of partial modes, pertaining to individual pulses, occurs. This effect causes a broadening of the impulses resulting in inter-symbol interferences.

The fiber birefringence rate is characterized by beat length l_b . It is possible to deduce from (5), that the state of polarization will transform periodically, as shows Fig. 6. Linear polarization of the wave with the polarization plane at angle 45° to x axis gradually

transforms across right-handed elliptical polarization to right-handed circular polarization. It transforms further across right-handed elliptical and linear polarization perpendicular to the original one. Then it transforms across left-handed elliptical and left-handed circular to perpendicular left-handed elliptical polarization and finally to original linear polarization. At this point, the total phase shift of the modes is $\Delta\phi = 2\pi$ and the corresponding fiber length is the fiber beat length l_b .

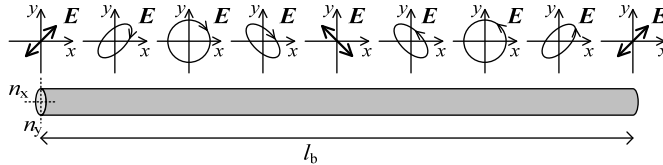

Fig. 6. Periodical transformation of the state of polarization in fiber with beat length l_b .

$$l_b = \frac{2\pi}{\beta_x - \beta_y} = \frac{\lambda}{n_{x,\text{eff}} - n_{y,\text{eff}}} = \frac{\lambda}{\Delta n_{\text{eff}}}, \tag{6}$$

where $n_{x,\text{eff}}$ and $n_{y,\text{eff}}$ are effective refractive indices in x axis and in y axis, Δn_{eff} is the difference of effective refractive indices and λ is light wavelength.

3.1 Linear birefringence owing to elliptical fiber core cross-section

As mentioned above, the linear birefringence may be of latent or induced nature. The main cause of latent linear birefringence in real fiber is the manufacture imperfection. The cross-section of the fiber core is not ideally circular but slightly elliptical, as shown in Fig. 7.

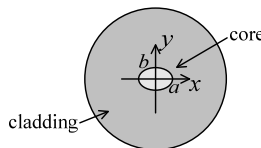

Fig. 7. Elliptical cross-section of the non-ideal fiber core.

Let the major axis of the ellipse representing core cross-section lies in the x axis direction and the minor axis lies in the y axis direction. The wave number of the mode, which propagates in x axis direction, will be of a larger magnitude than the wave number of the y axis mode. The difference of effective refractive indices Δn_{eff} is determined by the ellipticity ratio a/b . In case of small ellipticity rate, when $a \approx b$, holds the relation

$$\Delta n_{\text{eff}} = 0.2 \left(\frac{a}{b} - 1 \right) (\Delta n)^2, \tag{7}$$

where $\Delta n = n_{\text{co}} - n_{\text{cl}}$ is the difference of core refractive index n_{co} and cladding refractive index n_{cl} . For specific phase shift of the modes it may be derived from (7) a relation

$$\Delta\phi = \frac{0.4\pi}{\lambda} \left(\frac{a}{b} - 1 \right) (\Delta n)^2. \tag{8}$$

In order to attain a large beat length the fiber core should approach the circular cross-section as much as possible. It may be derived by means of (6) and (8) a demand for relative deviation from ideal circularity

$$\left(\frac{a}{b} - 1\right) \cdot 100\% = \frac{\lambda}{0.2l_b(n_{co} - n_{cl})^2} \cdot 100. \quad (9)$$

For typical single-mode fiber with $n_c = 1.48$, $n_{cl} = 1.46$ and operating wavelength $\lambda = 633$ nm the required deviation from ideal circularity achieves 0.016%. This demand is very hard to accomplish in fiber manufacture. The common fibers maintain the polarization state close to the initial only a few meters along.

3.2 Inner mechanical stress induced linear birefringence

The fiber core ellipticity is not a single source of fiber birefringence imposed by the manufacture. A second important source, which may take effect, is the presence of inner mechanical stress on the core. This may be caused by non-homogeneity of cladding density in area close to the core. In order to simplify the analysis we can consider an elliptical density distribution owing to imperfect technology process of fiber drawing from hot preform. The far area of the cladding influences the inner area by centripetal pressure after the fiber cooled down. Since the core-close area has a non-homogenous density, the pressures on core, p_x and p_y , will act non-uniformly as illustrates Fig. 8.

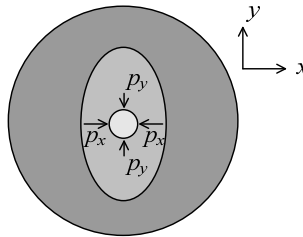

Fig. 8. Non-uniform stress on fiber core owing to imperfect inner structure.

Due to the photo-elastic effect, which causes pressure dependent anisotropy, the fiber core becomes a birefringent medium. Then, the difference of effective refractive indices in x axis and y axis is

$$\Delta n_{\text{eff}} = \frac{C_f}{1 - \nu_c} \Delta \nu \Delta T \frac{\frac{p_x}{p_y} - 1}{\frac{p_x}{p_y} - 1}, \quad (10)$$

where ν_c is Poisson constant of the core, $\Delta \nu$ is difference of expansion coefficients of outer and inner cladding areas, ΔT is difference between softening temperature of the cladding and the ambient temperature. Coefficient C_f is characteristic for given fiber, given by

$$C_f = \frac{1}{2} \left(\frac{n_{co} - n_{cl}}{2} \right)^3 (r_{11} - r_{12})(1 - \nu_{co}), \quad (11)$$

where r_{11} , r_{12} are components of photo-elastic tensor matrix of the fiber material. Photo-elastic matrix description is above the scope of this chapter and may be found in (Huard, 1997). For specific phase shift of the modes it may be derived from (10) a relation

$$\Delta\phi = \frac{2\pi}{\lambda} \frac{C_f}{1 - \nu_c} \Delta v \Delta T \frac{p_x/p_y - 1}{p_x/p_y - 1} \quad (12)$$

The influence of inner stress induced linear birefringence is weak in compare to birefringence owing to elliptical core cross-section in common single-mode fibers. However, the inner stress induced linear birefringence may be imposed intentionally in case of polarization maintaining (PM) fibers manufacture.

3.3 Outer mechanical stress induced linear birefringence

Linear birefringence in single mode fiber may be induced by outer influence also. It is caused by outer mechanical stress (pressure or tensile force) on fiber cladding. Cladding transfers the mechanical stress on the core and similar effect described above uprises. In practice, an action of force in one dominant direction appears usually. It induces origin of two axis of symmetry, x and y , with two refractive indices n_x and n_y again.

One of the possible effects causing linear birefringence is fiber bending, which is illustrated in Fig. 9. A fiber with cladding diameter d_{cl} is bended with diameter R . The fiber axis is equal to y axis direction. The pressure imposed on core in x axis increase refractive index n_x in compare to n_y due to the photo-elastic effect. In this configuration, the slow mode propagates in the bending plane xy and the fast mode propagates in plane yz .

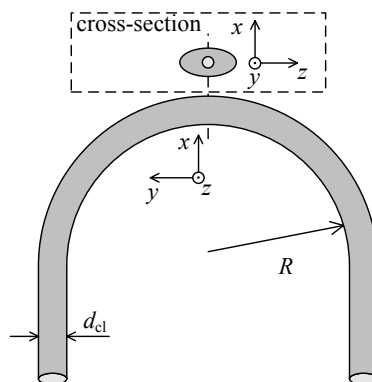

Fig. 9. Geometric relation of fiber bending causing induced linear birefringence.

The difference of effective refractive indices in x axis and y axis will be (Huard, 1997)

$$\Delta n_{\text{eff}} = \frac{1}{2} C_f \frac{d_{cl}^2}{R^2} + 2\zeta C_f \frac{d_{cl}}{R} \quad (13)$$

and related specific phase shift of the modes is expressed as

$$\Delta\phi = \frac{2\pi}{\lambda} \left[\frac{1}{2} C_f \frac{d_{cl}^2}{R^2} + 2\zeta C_f \frac{d_{cl}}{R} \right], \quad (14)$$

where C_f is fiber coefficient given by (11), ζ is the rate of axis deformation caused by longitudinal tensile force. The terms on the right side of relations (13) and (14) represent a situation when an additive tensile force acts on the fiber. This may occur when the fiber is bended over a solid, as a coil core. If the fiber is bended without the additive tensile force relations (13) and (14) are simplified. Then, the resultant relation for specific phase shift is

$$\Delta\phi = \frac{\pi}{\lambda} C_f \frac{d_{cl}^2}{R^2}. \quad (15)$$

Relation (15) may be substituted by relation, where the fiber coefficient C_f is replaced by the product of Young module of the fiber material E_c and photo-elastic coefficient of the fiber core \mathfrak{R} (Ulrich et al., 1980)

$$\Delta\phi = \frac{\pi}{\lambda} E_c \mathfrak{R} \frac{d_{cl}^2}{R^2}. \quad (16)$$

As in previous cases, it may be derived from (16) a relation for specific phase shift of the modes

$$\Delta\phi_{1z} = \frac{2\pi^2}{\lambda} E_c \mathfrak{R} \frac{d_{cl}^2}{R}. \quad (17)$$

When a one fiber turn with radius $R = 8$ cm would be formed from a typical single-mode fiber with $E_c = 7.45 \cdot 10^9$ Pa, $\mathfrak{R} = -3.34 \cdot 10^{-11}$ Pa $^{-1}$ (Namihiro, 1983) and $d_{cl} = 125$ μ m, the phase shift at wavelength $\lambda = 633$ nm achieves $\Delta\phi \approx -\pi/2$. In this case, for example linear polarization will be transformed into the circular. The original polarization state will be lost. A second significant effect, which induces linear birefringence in the fiber is a lateral pressure, which is illustrated in Fig. 10.

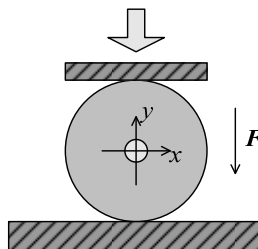

Fig. 10. Imposing a lateral pressure force on the fiber.

Induced anisotropy in the fiber is a result of photo-elastic effect, which is induced by compressing fiber between two planar solid slabs. If we consider F_m as a force acting on unit length, the phase difference of the fiber modes will be (Huard, 1997)

$$\Delta\phi = \frac{2\pi}{\lambda} C_f \frac{4F_m}{\pi d_{cl} E_c}. \quad (18)$$

The fast mode will propagate along the x axis and the slow one along the y axis. Lateral pressure induced birefringence may occur by fiber assembly in to optical components, such as connectors.

At the close of this chapter, there should be mentioned another way to induce the fiber linear birefringence. It may be imposed by electro-optical effect in the fiber core. However, the fiber core is made from amorphous material and the electro-optic effect is of a very weak character (Wagner et al., 1992).

4. Circular birefringence in optical fiber

In the case of circular birefringence analysis we introduce a concept of chiral birefringent medium. It exhibits two refractive indices n^r and n^l for right-handed and left-handed circular polarized waves. Counter rotating waves, which propagate in this medium, travel with different phase velocities and they gain a phase shift. Both of the circular polarized waves we may decompose on two linear polarized waves with equal amplitudes and with $\pi/2$ or $-\pi/2$ phase shift. Thus, the right-handed circular polarized wave propagating in z axis direction is a superposition of two orthogonal linear polarized waves described by components E_x^r and E_y^r . For their magnitudes holds

$$\begin{aligned} E_x^r(z,t) &= \frac{E_0}{2} \cos\left(\beta^r z - \omega t - \frac{\pi}{2}\right), \\ E_y^r(z,t) &= \frac{E_0}{2} \cos(\beta^r z - \omega t), \end{aligned} \quad (19)$$

where β^r is wave number of right-handed circular polarized wave. Likewise, for left-handed circular polarized wave components holds

$$\begin{aligned} E_x^l(z,t) &= \frac{E_0}{2} \cos\left(\beta^l z - \omega t + \frac{\pi}{2}\right), \\ E_y^l(z,t) &= \frac{E_0}{2} \cos(\beta^l z - \omega t), \end{aligned} \quad (20)$$

where β^l is wave number of left-handed circular polarized wave. Wave numbers of waves propagating in fiber core are given as

$$\beta^r = \frac{2\pi}{\lambda} n_j^r, \quad \beta^l = \frac{2\pi}{\lambda} n_j^l. \quad (21)$$

Due to the magnitude difference of refractive indices n_j^r and n_j^l in circular birefringent fiber core, the counter rotating waves travel with different phase velocities and they gain a phase shift

$$\Delta\phi = (\beta^r - \beta^l) l_f = \frac{2\pi}{\lambda} (\beta_j^r - \beta_j^l) l_f = \sigma_c l_f, \quad (22)$$

where σ_c is specific rotation of fiber core and l_f is fiber length.

When we superpose two circular polarized waves, which were described above, we obtain a linear polarized wave with a certain orientation of polarization plane. The change of polarization plane rotation angle $\Delta\alpha$ is equal to the phase shift $\Delta\phi$ from (22), $\Delta\alpha = \Delta\phi$.

It may be concluded, that the presence of circular birefringence in the fiber results in polarization plane rotation. When the fiber is free from linear birefringence and we couple a linear polarized wave into the fiber, we obtain a linear polarized wave with rotated polarization plane at the output. The angle of plane rotation is due to the circular birefringence rate and the fiber length.

In contrast to linear birefringence, circular birefringence of latent origin is negligible in common single-mode fiber. Nevertheless, it is possible to impose it in manufacturing process or induced it by outer influence. This can be attained by suitable applied mechanical stress or by magnetic field applying in the direction of fiber axis.

4.1 Outer mechanical stress induced circular birefringence

If a fiber section with length l_f is exposed to torsion with specific torsion rate τ

$$\tau = \frac{\delta}{l_f}, \quad (23)$$

where δ is torsion angle as shown in Fig. 11, a shear stress is imposed in plane perpendicular to fiber axis.

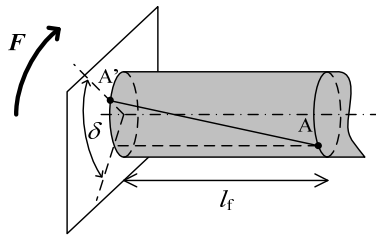

Fig. 11. A fiber section with length l_f exposed to torsion with angle δ .

Imposed shear stress results in fiber core anisotropy owing to photo-elastic effect. In order to describe optical properties of anisotropic fiber core, it is useful to exploit tensor matrix of dielectric constant $\boldsymbol{\varepsilon}$ (Saleh & Teich, 1991)

$$\boldsymbol{\varepsilon} = \boldsymbol{\varepsilon}_t + \Delta\boldsymbol{\varepsilon}_t = \begin{bmatrix} \varepsilon & 0 & 0 \\ 0 & \varepsilon & 0 \\ 0 & 0 & \varepsilon \end{bmatrix} + \begin{bmatrix} 0 & -g\tau y & 0 \\ g\tau y & 0 & -g\tau x \\ 0 & g\tau x & 0 \end{bmatrix} = \begin{bmatrix} \varepsilon & -g\tau y & 0 \\ g\tau y & \varepsilon & -g\tau x \\ 0 & g\tau x & \varepsilon \end{bmatrix}, \quad (24)$$

where $\boldsymbol{\varepsilon}_t$ is dielectric constant tensor of original medium and $\Delta\boldsymbol{\varepsilon}_t$ is tensor of torsion contribution. Coordinates x, y in matrix $\Delta\boldsymbol{\varepsilon}_t$ belongs to point A' in shear stress plane, where is the dielectric constant expressed and for coefficient g holds

$$g = r_{44}n_c^4 = (r_{11} - r_{12})n_c^4, \quad (25)$$

where r_{11} , r_{12} and r_{44} are components of photo-elastic matrix of the fiber core material. For further analysis, it is advantageous to exploit a Jones calculus (Jones, 1941) to characterize the influence of torsion modified medium on the polarization state of the wave. The relations of photo-elastic coefficients of the medium and Jones matrix of the medium are

beyond the scope of this chapter and may be found for example in (Iizuka, 2002). The Jones matrix of the torsion modified medium is in the form

$$T_c = \begin{bmatrix} 0 & -jg\tau \\ jg\tau & 0 \end{bmatrix}, \quad (26)$$

where j is imaginary unit. Jones matrix T_c describes the polarizing properties of circular birefringent medium. If we multiply matrix T_c with Jones vector J_1 of linear polarized wave, we obtain vector J_2 with imaginary components. Both of the components represent left-handed and right-handed circular polarized waves.

$$J_2 = T_c \cdot J_1 = \frac{1}{\sqrt{2}} \begin{bmatrix} 0 & -jg\tau \\ jg\tau & 0 \end{bmatrix} \cdot \begin{bmatrix} 1 \\ 1 \end{bmatrix} = \frac{1}{\sqrt{2}} \begin{bmatrix} -jg\tau \\ jg\tau \end{bmatrix}. \quad (27)$$

The phase shift of circular polarized waves $\Delta\phi$ and corresponding polarization rotation angle $\Delta\alpha$ is proportional to the torsion rate τ . Then, a twisted single mode fiber with length l_f acts as a polarization rotator with rotation angle

$$\Delta\alpha = g\tau l_f. \quad (28)$$

4.2 Magnetic field induced circular birefringence

The second source of fiber circular birefringence is magneto-optical effect. Between three types of magneto-optical effect (Cotton-Mouton, Kerr, Faraday) (Craig & Chang, 2003), the Faraday effect is significant for silica fiber. It induces circular birefringence owing to magnetic field action in direction along the fiber axis. Analogous to fiber torsion, the Faraday magneto-optical effect modifies the dielectric constant tensor

$$\varepsilon = \varepsilon_i + \Delta\varepsilon_{mo} = \begin{bmatrix} \varepsilon & 0 & 0 \\ 0 & \varepsilon & 0 \\ 0 & 0 & \varepsilon \end{bmatrix} + \begin{bmatrix} 0 & -j\eta B & 0 \\ j\eta B & 0 & 0 \\ 0 & 0 & 0 \end{bmatrix} = \begin{bmatrix} \varepsilon & -j\eta B & 0 \\ j\eta B & \varepsilon & 0 \\ 0 & 0 & \varepsilon \end{bmatrix}, \quad (29)$$

where $\Delta\varepsilon_{mo}$ is tensor of magneto-optical effect contribution, B is the magnitude of flux density of the external magnetic field, η is coefficient, which is proportional to magneto-optic specific rotation coefficient (Huard, 1997). Again, dielectric constant tensor (29) describes a birefringent medium, where right-handed and left-handed circular polarized waves travel with different velocities. Here, the resulting phase shift of the waves is proportional to magnitude of magnetic flux density and the length of birefringent medium.

In order to explain the origin of Faraday magneto-optical effect, it is possible to model the effect as an electron oscillator movement in magnetic field (Waynant & Ediger, 2000). The effect itself results from interaction of outer magnetic field with oscillating electron, which is excited by the electric field of the light wave. Electrons represent harmonic oscillators. For them equations of forced oscillations hold. In the presence of external magnetic field with flux density B , parallel to wave propagation direction, for the electron oscillator holds

$$m_e \frac{d^2 u}{dt^2} + \kappa u = -eE - e \left[\frac{du}{dt} \times B \right], \quad (30)$$

where m_e is electron mass, e is electron charge, \mathbf{u} is vector, which determines the electron displacement, $\kappa\mathbf{u}$ is quasi-elastic force preserving electron in equilibrium position, \mathbf{E} is electric field vector of propagating wave. Electric field of the wave polarizes the medium

$$\mathbf{P} = -N_e e \mathbf{u}, \quad (31)$$

where N_e is the count of electrons in volume unit, which are deflected by the electric field of the wave. Substituting equation (31) into (30) we get

$$\frac{d^2 \mathbf{P}}{dt^2} + \frac{e}{m_e} \left[\frac{d\mathbf{P}}{dt} \times \mathbf{B} \right] + \omega_0^2 \mathbf{P} = \frac{N_e e^2}{m_e} \mathbf{E}, \quad (32)$$

where ω_0 is frequency of the electron oscillator. Equation (32) represents the system of two simultaneous differential equations. We obtain two terms by their solution. One for the right-handed, second for the left-handed circular polarized wave in the medium (Born & Wolf, 1999)

$$\begin{aligned} E^r &= E_0^r e^{j\omega t}, \\ E^l &= E_0^l e^{j\omega t}, \end{aligned} \quad (33)$$

where ω is frequency of circular polarized waves. The macroscopic relation for the medium polarization due to the electric field of circular polarized waves is in the form

$$\begin{aligned} P^r &= \varepsilon_0 \chi^r E^r, \\ P^l &= \varepsilon_0 \chi^l E^l, \end{aligned} \quad (34)$$

where χ^r and χ^l are dielectric susceptibilities for right-handed and left-handed circular polarized waves and ε_0 is dielectric constant of vacuum. Refractive index of the medium is related to dielectric susceptibility

$$n^2 = \varepsilon_r = 1 + \chi, \quad (35)$$

where ε_r is relative dielectric constant of the medium. Substituting equations (34) into system (32) and by utilization of relation (35), we obtain relations for refractive indices of right-handed and left-handed circular polarized waves

$$\begin{aligned} (n_c^r)^2 &= 1 + \frac{N_e e^2}{\varepsilon_0 m_e} \cdot \frac{1}{\omega_0^2 - \omega^2 + \frac{e}{m_e} B \omega}, \\ (n_c^l)^2 &= 1 + \frac{N_e e^2}{\varepsilon_0 m_e} \cdot \frac{1}{\omega_0^2 - \omega^2 - \frac{e}{m_e} B \omega}. \end{aligned} \quad (36)$$

When we take into account certain simplifications, we can differentiate equations (36) and we can derive relation for polarization plane rotation in dependence on the outer magnetic field flux density B and on the interaction length l_f (fiber length in magnetic field)

$$\Delta\alpha = \Delta\phi = \frac{\pi N_e}{\epsilon_0 \lambda n_c} \frac{e^3}{m_e^2} \frac{\omega}{(\omega_0^2 - \omega^2)^2} B l_f = V B l_f, \quad (37)$$

where λ is wavelength of the wave, $\bar{n}_c = (n_c^r + n_c^i)/2$ is the mean refractive index, ω is angular frequency of the wave, V is Verdet constant, which characterizes magneto-optic properties of medium. It is obvious, that Verdet constant depends on the wavelength.

The right part of equation (37) is the basic relation for Faraday magneto-optic effect. The effect is non-reciprocal. The polarization rotation direction depends on the mutual orientation of magnetic flux density B and the wave propagation direction. The polarization of wave propagating in the direction of B experiences a rotation $\Delta\alpha$. The polarization of wave propagating in the opposite direction to B experiences a rotation $-(\Delta\alpha)$. This non-reciprocal character is important for example for polarization mode conjugation as will be shown later. The illustration of polarization plane rotation in fiber section due to Faraday magneto-optic effect is shown in Fig. 12.

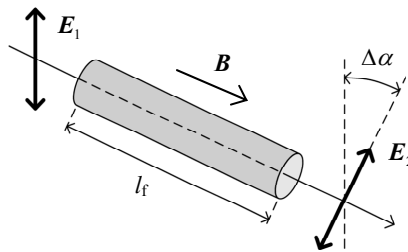

Fig. 12. Polarization plane rotation in fiber section due to Faraday magneto-optic effect.

5. Superposition of linear and circular birefringence in fiber

Both types of birefringence, linear and circular, may appear in single mode fiber. Both of them may be of latent or induced origin. The total phase shift of modes in fiber, determining the output polarization, is given by their geometrical average

$$\Delta\phi = \sqrt{\phi_c^2 + \left(\frac{\phi_l}{2}\right)^2}, \quad (38)$$

where ϕ_c is mode phase shift caused by circular birefringence and ϕ_l is mode phase shift caused by linear birefringence (Ripka, 2001). Generally, the polarization state of the output wave will be elliptical due to the linear birefringence and the orientation of axes of the polarization ellipse will rotate due to the circular birefringence. The analysis of the optical system with fiber, which exhibits both types of birefringence, may be performed by means of Jones calculus. Jones matrix of the fiber will be in the form (Tabor & Chen, 1968)

$$T_f = \begin{bmatrix} \cos \Delta\phi + j \frac{\phi_l}{2} \frac{\sin \Delta\phi}{\Delta\phi} & -\phi_c \frac{\sin \Delta\phi}{\Delta\phi} \\ \phi_c \frac{\sin \Delta\phi}{\Delta\phi} & \cos \Delta\phi - j \frac{\phi_l}{2} \frac{\sin \Delta\phi}{\Delta\phi} \end{bmatrix}, \quad (39)$$

where $\Delta\phi$ results from (38). By means of (39), it is possible to study transformation of polarization state of the wave, which passed through the fiber. Generally, in presence of both types of birefringence, the fiber behaves as phase retarder and polarization rotator simultaneously.

6. Techniques for unwanted fiber birefringence suppression

In previous chapters, it has been explained how the birefringence affects the polarization state of the wave in fiber. The transformation of polarization state is often unwanted, if we intend to use it as a carrier quantity.

It is important to suppress the polarization mode dispersion in telecommunication applications, in order to avoid pulses broadening. It is caused by linear birefringence. Important is also to avoid the unwanted birefringence in polarimetric sensors applications. It has to be ensured, that the polarization state will be modified by sensing quantity only. Polarimetric fiber optic sensor may be divided into two groups. Sensors of mechanical quantities (strain, pressure, vibrations) utilize induced linear birefringence. Sensors of magnetic field utilize induced circular birefringence. Since the inherent circular birefringence of common fibers is insignificant, the key parameter is the rate of linear birefringence.

The facts mentioned above place demands for methods for unwanted linear birefringence suppression. Following subchapters present a brief overview of the most significant selected methods, which are used to meet this requirement. The methods differ in view of its principle, efficiency or usability in various applications.

6.1 Polarization maintaining fibers

Polarization maintaining (PM) fibers have a specific inner structure, which allows maintaining polarization of the wave on long distances. In general view, polarization maintaining fibers may be divided in two groups. The first represents polarization maintaining fibers with low birefringence (PM LB). PM LB fiber approaches the concept of ideal fiber with constant circular cross-section and with very low linear birefringence. As has been mentioned above, these fibers are difficult to manufacture. Moreover, the manipulation (as bending or compressing) with fiber induces linear birefringence due to photo-elastic effect. In the second group belong polarization maintaining fibers with high birefringence (PM HB). A strong linear birefringence is imposed in the fiber by means of internal mechanical strain, which results in the loss of degeneracy of hybrid fiber modes HE_{11} . Therefore, the beat length of PM HB fibers is only a few millimeters. Hybrid modes propagate in fiber along the major and minor axis of ellipse, whose ellipticity is given by the ratio of mode wave numbers β_x and β_y . If the light wave, for example with linear polarization, is coupled into the fiber with polarization plane in direction of one of the axes, the both orthogonal wave modes will experience equal wave numbers and the equal refractive indices. The wave will propagate along the fiber without the polarization state transformation (Kaminow & Ramaswamy, 1979). The sensitivity on bending and temperature fluctuations is greatly reduced. Nevertheless, the insensitive polarization state preserving is ensured only for one certain polarization plane orientation, when both wave modes experience same refractive indices.

The principle of PM HB fibers manufacturing consists in implementing of stress components in the fiber cladding. Stress components impose symmetrical defined pressure force on

circular fiber core. Stress components are implemented by doping of designated cladding areas with atoms of certain elements, typically boron atoms. In this way, areas with different thermal expansion coefficient are formed. After the drawn fiber cools down, the doped areas cause inner strain, which acts on the fiber core. Doped areas may have variety of shapes as shown in Fig. 13. The influence of fiber latent linear birefringence is strongly exceeded by the imposed birefringence, which temperature and bending dependence is very weak.

In order to characterize the properties of PM HB fibers the polarization crosstalk CT is defined (Noda et al., 1986). Polarization crosstalk, defined by relation (40), is given by logarithmic ratio of optical power of excited mode P_x and optical power of coupled mode P_y . The polarization crosstalk is typically lower than -40 dB for fiber length of 100 meters (Senior, 2009).

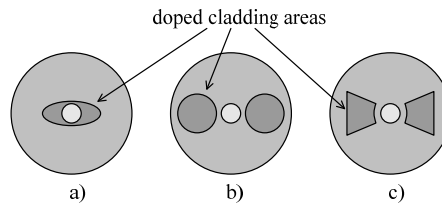

Fig. 13. Various profiles of PM HB fibers: a) elliptical, b) PANDA type, c) Bow-Tie type.

$$CT = 10 \log \frac{P_y}{P_x}. \quad (40)$$

In the following chapters, fibers with intended polarization preserving properties are discussed. Although they exploit different principles, they may be considered as a special type of PM LB or PM HB fibers, as will be mentioned.

6.2 Fibers with high circular birefringence

The demands of telecommunication applications for polarization state preserving in fiber may be satisfactory covered by PM fibers. Since, PM fiber allows preservation of state polarization only for one certain polarization plane orientation, they are not well suited for applications in polarimetric fiber sensors. The polarization plane rotates due to the sensing quantity magnitude in case of these sensors. Therefore, the different fiber modifications were studied.

6.2.1 Twisted fibers

One of the approaches is fiber twisting, which may impose a strong circular birefringence in the core. If the rate of induced circular birefringence will be much greater than the rate of linear birefringence, relation (38) may be modified

$$\Delta\phi = \sqrt{\phi_c^2 + \left(\frac{\phi_l}{2}\right)^2} \stackrel{\phi_c \gg \phi_l}{\cong} \sqrt{\phi_c^2} = \phi_c. \quad (41)$$

The influence of circular birefringence will dominate and the linear birefringence may be neglected. Since the effect of linear birefringence is canceled, twisted fibers belong to group

of PM LB fibers. Twisted fiber will behave as polarization plane rotator, which preserves the polarization state of the wave. The polarization plane rotation is proportional to specific rotation of the fiber core and σ_c and l_f is fiber length

$$\Delta\alpha = \sigma_c l_f. \quad (42)$$

If this principle would be utilized in polarimetric fiber sensor application, the polarization rotation due to sensed physical quantity will be additive to inherent polarization rotation of the fiber.

The circular birefringence in fiber core is possible to impose by fiber twisting in a plane, which is perpendicular to fiber longitudinal axis. The rate of circular birefringence corresponds to photo-elastic properties of the core, core refractive index, fiber length and specific torsion rate (relation (23)). In order to minimize the influence of linear birefringence, the specific torsion rate should be maximized. However, this is limited by torsion limit of the fiber. When exceeds, the fiber may be broken.

The disadvantage of the twisted fiber utilization in fiber sensing applications is the temperature dependence of twisting imposed circular birefringence, due to temperature dependence of core anisotropy. The next issue is the fabrication difficulty of small fiber coils for magnetic field sensing around conductors. The bending induced linear birefringence achieves a higher magnitude for small fiber coils. Therefore, the large torsion rate of the fiber has to be used and it may exceed the torsion limit. The approximate torsion limit of common single mode fiber is 100 turns per 1 meter (Payne et al., 1982). Taking into account this limit, it is possible to fabricate fiber coils with minimal diameter of 15 cm (Laming & Payne, 1989).

6.2.2 Spun low- and high-birefringent fibers

The more sophisticated approach to linear birefringence suppression was development of spun fibers. Spun fiber fabrication consists in twisting of melted preform during fiber drawing. During the fiber drawing, all fiber imperfections, as deviation from circularity and other non-uniformities, are spread out in all directions. Therefore, phase retardations, which experience propagating modes, cancel each other out. Since the twisted preform is melted, no stress induced anisotropy is present in the core after the fiber cools down. Simultaneously, the fiber is free from temperature dependency effects. Hence, the spun fiber behaves as an ideal fiber with circular cross-section core, which retain any polarization state of coupled wave, from the input to the output. In principle, spun fibers belong to group of PM LB fibers. We designate them as low-birefringent spun fibers (spun LB). Spun LB fiber exhibits only a negligible latent circular birefringence, due to limited viscosity of the preform during the drawing. The principle of spun LB fiber implies their main disadvantage, which is the sensitivity on fiber bending. This results in stress induced linear birefringence and the limitation for small radius fiber coil fabrication remains (Payne et al., 1982).

A similar concept of spun LB fiber represents highly birefringent spun fibers (Spun HB). Spun HB fibers are manufactured by rotating of melted preform also. However, the preform is prepared as for classical PM HB fiber, e.g. Bow-Tie (Laming & Payne, 1989). Spun HB fiber transforms the input linear polarization on to the elliptical. By carefully chosen rotation rate of the preform in relation to the fiber linear birefringence rate, it is possible to attain quasi-circular birefringence with negligible residual linear birefringence (Payne et al., 1982). Generally, we may consider spun HB fibers as a type of PM HB fiber group. The advantage of spun HB fibers is considerable immunity to rising of linear birefringence by fiber bending

or compressing. Since the quasi-circular birefringence in the fiber originates from twisting of stress components, the temperature dependence of anisotropy is indispensable. Therefore temperature compensation has to be used in applications utilizing spun HB fibers. On the present, spun HB fibers for telecommunication and sensing application are available for wavelengths from 600 nm to 1600 nm, with attenuation in order of ones of dB·km⁻¹. They may be wind on fiber coils with radius above 20 mm.

In connection with recent advances in microstructured fibers research, new possibilities of spun fiber fabrication emerge. The concept of microstructured fiber allows designing and producing of fibers with specific parameters on selected wavelength, single mode or multi mode character, polarization transformation properties and others. A development of microstructured spun fiber with six air chambers around the core and attenuation below 5 dB·km⁻¹ is reported in (Nikitov et al., 2009). The possibility of circular polarization transmission has been achieved by rotating of the microstructured preform, together with magneto-optic properties preservation. The fiber coils with diameter above 2.5 mm can be fabricated for current sensing application.

6.3 Annealed fibers

Drawback of twisted fibers and spun HB fibers, which is anisotropy temperature dependence, limits their applicability mainly in polarimetric current sensor applications. A method for suppression of temperature dependence of anisotropy together with the suppression of bending induced linear birefringence has been proposed and experimentally studied (Stone, 1988; Rose et al., 1996). The method utilizes annealing of fabricated fiber coil. The procedure consists in temperature treatment of the fiber coil, which is installed in ceramic labyrinth. The coil is then heated up with approximate temperature-time gradient $\Delta T/\Delta t = 8 \cdot 10^{-2} \text{ }^\circ\text{C}\cdot\text{s}^{-1}$. When 850 °C is reached, the temperature is maintained for roughly 24 hours. Then, the slow cooling follows with approximate gradient $\Delta T/\Delta t = -3 \cdot 10^{-3} \text{ }^\circ\text{C}\cdot\text{s}^{-1}$. Annealed fiber coil is then transferred into protective case, which is filled with low-viscosity gel in order to damp the vibrations. The annealing procedure leads to removing of bending induced stress on the fiber and the linear birefringence is greatly suppressed. Prior to the annealing procedure, the fiber jacket and buffer has to be removed, because its oxidation at the temperatures 500 - 600 °C would damage the fiber. Since the fiber jacket and buffer act as fiber strength element, their removal is difficult and fiber rupture impends. The outer layers removal is facilitated by etching in organic solvent. The oxidation proceeds then without the negative influence on the fiber cladding (Rose et al., 1996).

Due to considerable temperature stability, the annealing method is used for fabrication of fiber current sensors, which are installed in outdoor environment on high voltage systems. The need for reliable galvanic isolation and accuracy predominates the technological difficulties in fiber coil fabrication. The annealing procedure has to be carefully performed and it has to be handled a technology of fiber coil isolation from vibrations. Since the fiber strength outer layers have been removed, the fiber coils have increased sensitivity to vibrations. For outdoor installations on high voltage system an annealed fiber sensors with sensitivity variation smaller than 0.2 %, dynamic range of 80 dB and temperature range 20-80 °C were developed (Higuera-Lopez, 2002).

6.4 Reciprocal compensation of linear birefringence

In combination with fibers, which were described above and with common single mode fibers also, another perspective approach for linear birefringence suppression may be

exploited. The approach is based on reciprocity of linear birefringence. Beyond this, the circular birefringence is of non-reciprocal character, which gives usability especially in polarimetric current fiber sensors. Utilizing this fact, a compensation of linear birefringence may be performed on sensor output signal level in case of counter-propagating of two light waves in fiber. Second possibility consists in compensation of modes phase shift on fiber level in case of back-propagating of light wave with ortho-conjugated polarization.

6.4.1 Compensation on sensor output signal level

Since the linear birefringence is of reciprocal character, its influence on polarization state of the wave in fiber is not dependent on the propagation direction. The wave will experience the same polarization state transformation with the same orientation, no matter the propagation direction. Conversely, the magnetic field induced circular birefringence is non-reciprocal. When the wave will propagate in one direction, it will gain a polarization rotation. When the wave will propagate in opposite direction, it will gain rotation in opposite direction. The total rotation will be the double of the rotation in one direction.

Setups, which exploit the reciprocity of linear birefringence, have been demonstrated as polarimetric current sensors. An example of the sensor setup is shown in Fig. 14 (Claus & Fang, 1996).

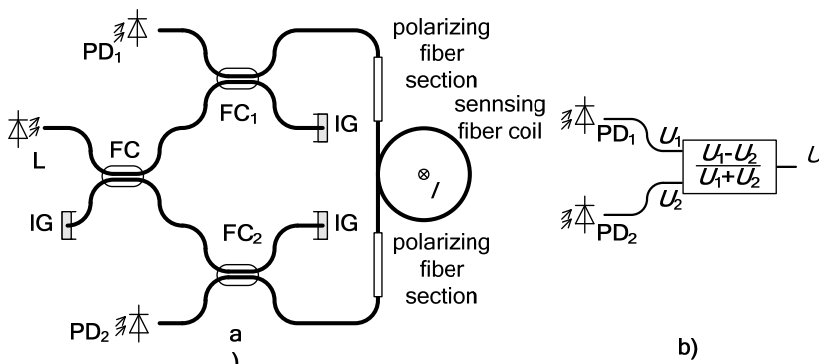

Fig. 14. Sensor setup with compensation on output signal level a), signal processing b).

In Fig. 14a), the signal from laser source L is divided into two channels by means of fiber coupler FC . After passing FC_1 and FC_2 , the two optical signals propagate in opposite direction through the polarizing parts and the sensing part of the fiber. The unused coupler outputs are led into immersion gel to avoid reflections. The optical signals are sensed by photodetectors PD_1 , PD_2 . For output voltage signals of the detectors we can deduce

$$\begin{aligned} U_1 &= R_{U,1} \cdot FC_1 \cdot T_{ov}^- \cdot FC_2 \cdot FC \cdot P_o, \\ U_2 &= R_{U,2} \cdot FC_2 \cdot T_{ov}^+ \cdot FC_1 \cdot FC \cdot P_o, \end{aligned} \quad (43)$$

where P_o is the input optical power. FC , FC_1 , FC_2 are split ratio of coupler FC , FC_1 , FC_2 , T_{ov}^+ and T_{ov}^- are polarizing transfer functions of the fiber path in one and in second direction, $R_{U,1}$, $R_{U,2}$ are responsivities of photodetectors. For correct operation, it must hold $FC = FC_1 = FC_2 = 0,5$ and $R_{U,1} = R_{U,2} = R_U$. Relation (43) transforms into

$$\begin{aligned} U_1 &= R_U \cdot FC^3 \cdot T_{ov}^-, \\ U_2 &= R_U \cdot FC^3 \cdot T_{ov}^+. \end{aligned} \quad (44)$$

In signal processing block, as shown in Fig. 14b), the normalized difference is computed

$$U = \frac{U_1 - U_2}{U_1 + U_2} = \frac{R_U \cdot FC^3 \cdot (T_{ov}^- - T_{ov}^+)}{R_U \cdot FC^3 \cdot (T_{ov}^- + T_{ov}^+)} = \frac{T_{ov}^- - T_{ov}^+}{T_{ov}^- + T_{ov}^+}. \quad (45)$$

Considering the presence of reciprocal linear birefringence only, the equality $T_{ov}^+ = T_{ov}^-$ holds. The output signal according to (45) will be zero. Since the magnetic field induced circular birefringence is non-reciprocal, the equality of polarizing transfer functions will not hold. Hence, the system will be responsive on varying rotation due to induced circular birefringence. Sensor utilizing above described principle dispose of considerable temperature stability and vibration insensitivity. More detailed description and sensor properties may be found in (Fang et al., 1994; Wilsch et al., 1996).

6.4.2 Orthogonal conjugation compensation

The reciprocity of undesirable birefringences in optical fiber may be used for their compensation exploiting the polarization ortho-conjugation of the wave modes. The method involves the back-propagation of light wave with conjugated modes through the same section of birefringent fiber.

As it has been stated above, imposing stress on fiber (pressure, bending) leads to origin of linear birefringent fiber core with two refractive indices, one lying in x axis direction - n_x and second lying in y axis direction - n_y . We may designate the axis as the fast fiber axis, with lower refractive index, and the slow fiber axis, with higher refractive index. However, the orientation of the fast and slow axes system towards the geometrical coordinate system of the fiber changes along, in dependence on the bending or pressure force orientation. The modes propagating with different refractive indices gain a phase shift to each other, which results in wave polarization transformation. Since the instantaneous magnitudes of refractive indices in fast and slow axis may vary due to rate of bending or compressing, the resulting phase difference relies on average magnitudes of the refractive indices in both axes.

In order to restore the original polarization state, the wave at the output of the birefringent fiber has to be reflected and coupled back in the fiber together with modes conjugation. To accomplish this, Faraday polarization rotator and flat mirror is exploited, as shown in Fig. 15. The whole device is called ortho-conjugation reflector (OCR) or often Faraday

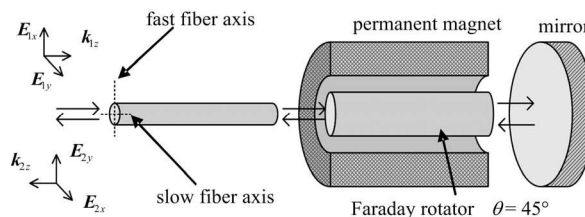

Fig. 15. Principle of Faraday rotation mirror.

rotation mirror (FRM). It consists of Faraday rotator, mounted inside a permanent magnet, flat mirror and collimator (for fiber optic application). The magnetic field magnitude, rotator dimension and its assembly is properly adjusted, that a light wave polarization is rotated with angle 45° while passing the rotator. Mirror allows reflection in perpendicular direction and collimator serves for fiber coupling.

Consider a birefringent fiber with a fast axis and a slow axis, Fig. 15. The modes of light wave, which travels in fiber, gain a phase shift. The mode in slow axis is retarded, while the mode in fast axis travels faster. At the fiber output, the wave is collimated to rotator. It rotates the wave polarization with angle $\theta/2 = 45^\circ$ during a single pass. Then the wave is reflected back. After the second rotator pass, the rotation angle is $\theta = 90^\circ$ due to the rotation non-reciprocity. The wave is coupled back into the fiber. Now, the wave propagates in fiber in backward direction. The wave mode, which traveled previously along the fast axis, travels now along the slow axis. Conversely, the mode, which traveled previously along the slow axis, travels now along the fast axis. The total phase shift of the modes is equalized and the original polarization state is restored. It should be mentioned, although the difference of average refractive indices will no be constant in time (for example by fiber manipulation), the final phase shift will remain zero thanks to reciprocal compensation. The temperature stability of the method is considerable also. However, this is true only when the temperature of FRM is stable, since the Verdet constant of rotator in FRM is temperature dependent.

Though the principle is not applicable for telecommunication purposes, it may be utilized in applications, where the polarization state preservation is desirable. This is often required in erbium-doped fiber amplifiers or tunable fiber lasers. Fiber optic sensors are another field of application. In case of fiber interferometers a polarization state of waves incoming from reference arm and sensing arm has to be preserved in order to interfere. Therefore, FRMs are used in both arms of interferometer. Fiber optic current sensors are another example of usage of FRM (Drexler & Fiala, 2008). Fiber current sensors exploit polarization rotation of the guided wave due to the magnet field actuation. Since the circular birefringence owing to Faraday magneto-optic effect is of non-reciprocal character, it will not be compensated during the backward propagation. Moreover, the polarization rotation will be double, which improves the sensitivity of the sensor. The example of fiber optic polarimetric current sensor utilizing FRM is shown in Fig. 16 (Drexler & Fiala, 2009). Laser beam from laser source L is collimated by means of collimator C and linear polarized by means of polarizer P. Beam passes a non-polarizing beam splitter NBS and it is collimated

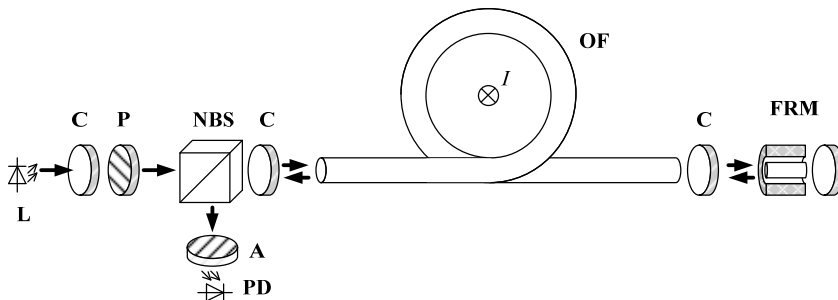

Fig. 16. Fiber optic polarimetric current sensor utilizing Faraday rotation mirror.

into the fiber by collimator C. The beam propagates through the magnetic field sensing fiber OF and exits the fiber. Collimator C collimates the beam into the FRM and collimates backward beam back into the fiber. The beam travels the fiber in opposite direction. After the collimation, part of the beam is deflected by beam splitter NBS. It passes the analyzer A and hits the photodetector PD. The output linear polarization state is perpendicular to the input linear polarization state. When magnetic field acts on the sensing part of the fiber, the polarization plane rotates. The polarization modulation is converted on intensity modulation by means of analyzer A.

In spite of the advantages of the FRM application, several drawbacks limits its usage. One of the drawbacks is temperature dependence of rotator Verdet constant (Santoyo-Mendoza & Barmenkov, 2003). Therefore the FRM unit has to be temperature stabilized. Simultaneously, it has to be shielded from outer magnetic field. Indispensable is the cost of this solution also owing to precise fabrication and adjusting of the FRM. Commercially available are FRMs in compact fiber pigtailed housing for longer wavelengths (1310 nm, 1550 nm). There are also available FRMs for shorter wavelengths (633 nm). However, they are bulky, because of the need of more powerful magnet.

7. Conclusion

Due to their unique properties, single mode fibers have found a huge application potential in various fields of industry and science. They are massively exploited in telecommunication technology, control and sensor systems, industrial laser systems and they represent an unsubstitutable tool for advanced science. The requirements for specific fiber properties differ for various applications. In lot of them, a transmission of light wave with preserving of state of polarization is demanded, which is often a weak point of common fibers. However, this drawback is possible to overcome with a suitable approach, depending on demands of particular application.

In order to evaluate the possibility of polarization state distortion, various influences have to be conceived. It is also very advantageous to be able to quantify them. According to this demand, the intention of the first part of the contribution is to specify the fundamental effects, which lead to fiber birefringence. The basic relations, which allow estimating the birefringence rate are presented also.

Once the fiber birefringence occurs, in lot of cases arises a need to suppress its undesirable consequences. A various approaches, which may be utilized, are the point of the interest of the second part of the contribution. The principles of the most significant methods are described. Their advantages and disadvantages are presented also. The suitability of a selected method is given by the application requirements. They differ in cost, complexity, temperature and mechanical stability and others. Because of the limited extent of this contribution, all of the methods properties and details could not be presented. Nonetheless, the chapter may be a convenient starting point for orientation in this field and details may be found in cited reference sources.

8. Acknowledgement

The contribution has been prepared with support of research project GA102/09/0314 of the Czech Science Foundation and project FEKT-S-10-13 of the Grant Agency of Brno University of Technology.

9. References

- Born, M. & Wolf, E. (1999). *Principles of Optics*, Cambridge University Press, ISBN 978-0521642224, Cambridge
- Claus, R. O. & Fang, X. (1996). Optimal Design of IRIS-Based Polarimetric Intrinsic Optic Current Sensor. *Journal of Lightwave Technology*, Vol. 14, No. 7, pp. (1664-1673), ISSN 0733-8724
- Craig, A. E. & Chang, K. (Ed(s)). (2003). *Handbook of Optical Components and Engineering*, John Wiley & Sons, ISBN 0-471-39055-0, New Jersey
- Drexler, P. & Fiala, P. (2008). Utilization of Faraday mirror in fiber optic current sensors. *Radioengineering*, Vol. 17, No. 4, pp. (101-107), ISSN 1210-2512.
- Drexler, P. & Fiala, P. (2009). Suppression of polarimetric birefringence effect in optical fiber and its application for pulsed current sensing, *Proceedings of 2009 Waveform Diversity & Design Conference*, ISBN 978-1-4244-2971- 4, USA: Orlando, 2009
- Fang, X., Wang, A., May, R. G. & Claus, R. O. (1994). A Reciprocal-Compensated Fiber Optic Current Sensor. *Journal of Lightwave Technology*, Vol. 12, No. 10, pp. (1882-1890), ISSN 0733-8724
- Higuera-Lopez, J. M. (2002). *Handbook of Optical Fiber Sensing Technology*, John Wiley & Sons, ISBN 978-0-471-82053-6, New York
- Huard, S. (1997). *Polarization of Light*, John Wiley & Sons, ISBN 2-225-85327-X, Paris
- Iizuka, K. (2002). *Elements of Photonics, Volume II*, John Wiley & Sons, ISBN 0-471-83938-8, Toronto
- Jones, R. C. (1941). New calculus for the treatment of optical systems. *Journal of the Optical Society of America*, Vol. 31, No. 7, ISSN 1862-6254
- Kaminow, I. P. and Ramaswamy, V. (1979). Single-polarization optical fibers: slab model. *Applied Physics Letters*, No. 34, pp. (268-270), ISSN 0003-6951
- Laming, R. I. & Payne, D. N. (1989). Electric current sensors employing spun highly birefringent optical fibers. *Journal of Lightwave Technology*, Vol. 7, No. 12, pp. (2084-2094), ISSN 0733-8724
- Namihira, Y. (1983). Opto-elastic constants in single-mode optical fibers. *Journal of Lightwave Technology*, Vol. 3, No. 5, pp. (1078-1083), ISSN 0733-8724
- Nikitov, S., Chamorovskiy, Y., Starostin, N., Ryabko, M., Morshnev, S., Morshnev, V. & Vorob'ev, I. (2009). Microstructured optical fibers for the fiber optics sensors, *Proceedings of International Conference on Materials for Advanced Technologies*, Singapore, June 2009
- Noda, J., Okamoto, K. & Sasaki, J. (1986). Polarization-maintaining fibers and their applications. *Journal of Lightwave Technology*, Vol. 4, No. 8. pp. (1071-1089), ISSN 0733-8724
- Payne, D. N., Barlow, A. J. & Hansen, J. J. R. (1982). Development of Low- and High-Birefringence Optical Fibers. *IEEE Transaction on Microwave Theory and Techniques*, Vol. 30, No. 4, pp. (323-334), ISSN 0018-9480
- Ripka, P. (Ed(s)). (2001). *Magnetic sensors and magnetometers*, Artech House, ISBN 1-58053-057-5, London
- Rose, A., Ren, Z. F. & Day, G. W. (1996). Twisting and annealing optical fiber for current sensors. *Journal of Lightwave Technology*, Vol. 14, No. 11, pp. (2492-2498), ISSN 0733-8724

- Saleh, B. A. & Teich, M. C. (1991). *Fundamentals of Photonics*, John Wiley & Sons, ISBN 978-0471839651, New York
- Santoyo-Mendoza, F. & Barmenkov, Y. O. (2003). Faraday plasma current sensor with compensation for reciprocal birefringence induced mechanical perturbations. *Journal of Applied Research and Technology*, Vol. 1, No. 2, pp. (157-163), ISSN 1665-6423
- Senior, J. M., (2009). *Optical Fiber Communication: Principles and Practice*, Pearson Education, ISBN 978-0-13-032681
- Stone, J. (1988). Stress-optic effect, birefringence, and reduction of birefringence by annealing in fiber Fabry-Perot interferometers. *Journal of Lightwave Technology*, Vol. 6, No. 7, pp. (1245-1248), ISSN 0733-8724
- Tabor, W. J. & Chen, F. S. (1968). Electromagnetic Propagation Through Materials Processing both Faraday Rotation and Birefringence: Experiments with Ytterbium Orthoferrite. *Journal of Applied Physics*, Vol. 10, pp. (2760-2765), ISSN 0021-8979
- Ulrich, R., Rashleigh, S. C. & Eickhoff, W. (1980). Bending-induced birefringence in single-mode fibers. *Optical Letters*, Vol. 5, No. 5, pp. (273 - 275), ISSN 1539-4794
- Wagner, E., Dändliker, R. & Spenner, K. (Ed(s)). (1992). *Sensors, a comprehensive survey, Volume 6 - Optical Sensors*, VCH, ISBN 3-527-26772-7, Weinheim
- Waynant, R. & Ediger, M. (2000). *Electro-Optics Handbook*, McGraw-Hill Professional, ISBN 978-0-07-068716-5, New York
- Wilsch, M., Menke, P. & Bosselman, T. (1996). Magneto-optic current transformers for applications in power industry, *Proceedings of 2nd Congress of Optical Sensor Technology OPTO 1996*, Germany: Leipzig, 1996

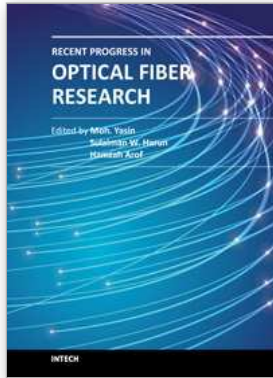

Recent Progress in Optical Fiber Research

Edited by Dr Moh. Yasin

ISBN 978-953-307-823-6

Hard cover, 450 pages

Publisher InTech

Published online 25, January, 2012

Published in print edition January, 2012

This book presents a comprehensive account of the recent progress in optical fiber research. It consists of four sections with 20 chapters covering the topics of nonlinear and polarisation effects in optical fibers, photonic crystal fibers and new applications for optical fibers. Section 1 reviews nonlinear effects in optical fibers in terms of theoretical analysis, experiments and applications. Section 2 presents polarization mode dispersion, chromatic dispersion and polarization dependent losses in optical fibers, fiber birefringence effects and spun fibers. Section 3 and 4 cover the topics of photonic crystal fibers and a new trend of optical fiber applications. Edited by three scientists with wide knowledge and experience in the field of fiber optics and photonics, the book brings together leading academics and practitioners in a comprehensive and incisive treatment of the subject. This is an essential point of reference for researchers working and teaching in optical fiber technologies, and for industrial users who need to be aware of current developments in optical fiber research areas.

How to reference

In order to correctly reference this scholarly work, feel free to copy and paste the following:

Petr Drexler and Pavel Fiala (2012). Optical Fiber Birefringence Effects – Sources, Utilization and Methods of Suppression, *Recent Progress in Optical Fiber Research*, Dr Moh. Yasin (Ed.), ISBN: 978-953-307-823-6, InTech, Available from: <http://www.intechopen.com/books/recent-progress-in-optical-fiber-research/optical-fiber-birefringence-effects-sources-utilization-and-methods-of-suppression>

INTECH
open science | open minds

InTech Europe

University Campus STeP Ri
Slavka Krautzeka 83/A
51000 Rijeka, Croatia
Phone: +385 (51) 770 447
Fax: +385 (51) 686 166
www.intechopen.com

InTech China

Unit 405, Office Block, Hotel Equatorial Shanghai
No.65, Yan An Road (West), Shanghai, 200040, China
中国上海市延安西路65号上海国际贵都大饭店办公楼405单元
Phone: +86-21-62489820
Fax: +86-21-62489821

© 2012 The Author(s). Licensee IntechOpen. This is an open access article distributed under the terms of the [Creative Commons Attribution 3.0 License](#), which permits unrestricted use, distribution, and reproduction in any medium, provided the original work is properly cited.