

The Phenomenon of Wireless Energy Transfer: Experiments and Philosophy

Héctor Vázquez-Leal, Agustín Gallardo-Del-Angel,
Roberto Castañeda-Sheissa
and Francisco Javier González-Martínez
University of Veracruz
Electronic Instrumentation and Atmospheric Sciences School
México

1. Introduction

There is a basic law in thermodynamics; the law of conservation of energy, which states that *energy may neither be created nor destroyed just can be transformed*. Nature is an expert using this physics fundamental law favouring life and evolution of species all around the planet, it can be said that we are accustomed to live under this law that we do not pay attention to its existence and how it influence our lives.

Since the origin of the human kind, man has been using nature's energy in his benefit. When the fire was discovered by man, the first thing he tried was to transfer it where found to his shelter. Later on, man learned to gather and transport fuels like mineral charcoal, vegetable charcoal, among others, which then would be transformed into heat or light. In fact, energy transportation became so important for developing communities that when the electrical energy was invented, the biggest and sophisticated energy network ever known by the human kind was quickly built, that is, the electrical grid. Such distribution grid pushed great advances in science oriented to optimize the efficiency on driving such energy. Nevertheless, is common to lose around 30% of energy due to several reasons. Nowadays, there are some daily life applications that could use an energy transport form without cables, some of them could be:

- Medical implants. The advance in biomedical science has allowed to create biomedical implants like: pacemakers, cochlear implants, subcutaneous drug supplier, among others.
- Charge mobile devices, electrical cars, unmanned aircraft, to name a few.
- Home appliances like irons, vacuum cleaners, televisions, etc.

Such potential applications promote the interest to use a wireless energy transfer. Nevertheless, nature has always been a step beyond us, doing energy distribution and transformation since a long while without the need of copper cables. The biggest wireless transfer source known is solar energy; nature uses sunlight to drive the photosynthesis process, generating this way nutrients that later on will become the motor for the food chain and life. At present, several ways to turn sunlight into electrical power have been invented,

among them, the photo-voltaic cells are the most popular. However, collecting solar energy is just the first step, the distribution of this energy is the other part of the problem, that is, the new objective is to wirelessly transfer point to point the energy.

This new technological tendency towards wireless energy is not as new as one might think. It is already known that the true inventor of the radio was Nikola Tesla, therefore, makes sense to think this scientist inferred, if it was possible to transfer information using an electromagnetic field, it would be also possible to transfer power using the same transmission medium or vice versa. Thus, in the early 19-th century this prominent inventor and scientist performed experiments (Tesla (1914)) regarding the wireless energy transfer achieving astonishing results by his age. It has been said that Tesla's experiments achieved to light lamps several kilometres away. Nevertheless, due to the dangerous nature of the experiments, low efficiency on power transfer, and mainly by the depletion of financial resources, Tesla abandoned experimentation, leaving his legacy in the form of a patent that was never commercially exploited.

Electromagnetic radiation has been typically used for the wireless transmission of information. However, information travels on electromagnetic waves which are a form of energy. Therefore, in theory it is possible to transmit energy similarly like the used to transfer information (voice and data). In particular, it is possible to transfer in a directional way great powers using microwaves (Glaser (1973)). Although the method is efficient, it has disadvantages: requires a line of sight and it is a dangerous mechanism for living beings. Thus, the wireless energy transfer using the phenomenon of electromagnetic resonance has become in a viable option, at least for short distances, since it has high efficiency for power transfer. The authors of (Karalis et al. (2008); Kurs (2007)) claim that resonant coupling do not affect human health.

At present, energy has been transferred wirelessly using such diverse physical mechanisms like:

- Laser. The laser beam is coherent light beam capable to transport very high energies, this makes it in an efficient mechanism to send energy point to point in a line of sight. NASA (NASA (2003)) introduced in 2003 a remote-controlled aircraft wirelessly energized by a laser beam and a photovoltaic cell infra-red sensitive acting as the energy collector. In fact, NASA is proposing such scheme to power satellites and wireless energy transfer where none other mechanism is viable (NASA (2003)).
- Piezoelectric principle (Hu et al. (2008)). It has been demonstrated the feasibility to wirelessly transfer energy using piezoelectric transducers capable to emit and collect vibratory waves.
- Radio waves and Microwaves. In (Glaser (1973)) is shown how to transmit high power energy through long distances using Microwaves. Also, there is a whole research field for rectennas (J. A. G. Akkermans & Visser (2005); Mohammad Ali & Dougal (2005); Ren & Chang (2006); Shams & Ali (2007)) which are antennas capable to collect energy from radio waves.
- Inductive coupling (Basset et al. (2007); Gao (2007); Low et al. (2009); Mansor et al. (2008)). The inductive coupling works under the resonant coupling effect between coils of two LC circuits. The maximum efficiency is only achieved when transmitter and receiver are placed very close from each other.

- "Strong" electromagnetic resonance. In (Karalis et al. (2008); Kurs (2007)) was introduced the method of wireless energy transfer, which use the "strong" electromagnetic resonance phenomenon, achieving energy transfer efficiently at several dozens of centimetres.

Transferring great quantities of power using magnetic field creates, inevitably, unrest about the harmful effects that it could cause to human health. Therefore, the next section will address this concern.

2. Electromagnetic waves and health

Since the discovering of electromagnetic waves a technological race began to take advantage of transferring information wirelessly. This technological race started with Morse code transmission, but quickly came radio, television, cellular phones and the digital versions for all the mentioned previously. Adding to the mentioned before, in the last decade arrived an endless amount of mobile devices capable to communicate wirelessly; these kind of devices are used massively around the globe. As a result, it is common that an average person is subjected to magnetic fields in frequencies going from Megahertz up to the Gigahertz. Therefore, the concerns of the population about health effects due to be exposed to all the electromagnetic radiation generated by our society every day. Besides, added to the debate, is the concern for the wireless energy transfer mechanisms working with electromagnetic signals.

Several studies have been completed (Breckenkamp et al. (2009); Habash et al. (2009)) about the effects of electromagnetic waves, in particular for cellular phones, verifying that just at the upper international security levels some effects to genes are noticed. In (Peter A. Valberg & Repacholi (2007)) is assured that it is not yet possible to determine health effects either on short or long terms due by the exposition to electromagnetic waves like the ones emitted by broadcasting stations and cellular networks. Nevertheless, in (Valborg Baste & Moe (2008)) a study was performed to 10,497 marines from the Royal Norwegian Navy; the result for the ones who worked within 10 meters of broadcasting stations or radars, was an increase on infertility and a higher birth rate of women than men. This increase of infertility agrees with other study (Irgens A & M (1999)) that determined that the semen quality decay in men which by employment reasons (electricians, welders, technicians, etc.) are exposed to constant electromagnetic radiation including microwaves. These studies conclude that some effects on the human being, in fact occur, mainly at high frequencies.

3. Acoustic and electrical resonance

The mechanical resonance or acoustic is well known on physics and consists in applying to an object a vibratory periodic action with a vibratory period that match the maximum absorption energy rate of the object. That frequency is known as resonant frequency. This effect may be destructive for some rigid materials like when a glass breaks when a tenor sings or, in extreme cases, even a bridge or a building may collapse due to resonance; whether it is caused by the wind or an earthquake.

Resonance is a well known phenomenon in mechanics but it is also present in electricity; is known as electrical resonance or inductive resonance. Such phenomenon can be used to transfer wireless energy with two main advantages: maximum absorption rate is guaranteed

and it can work in low frequencies (less dangerous to humans). When two objects have the same resonant frequency, they can be coupled in a resonant way causing one object to transfer energy (in an efficient way) to the other. This principle can be exploited to transmit energy from one point to another by means of an electromagnetic field. Next, three wireless energy transfer mechanisms are described:

1. **Inductive coupling (Mansor et al. (2008))** is a resonant coupling that takes place between coils of two LC circuits with the same resonant frequency, transferring energy from one coil to the other as it can be seen in figure 1(a). The disadvantage of this technique is that efficiency is lost as fast as coils are separated.
2. **Self resonant coupling (Karalis et al. (2008))**. The self resonance occur in a natural way for all coils (L), although the frequency

$$f_r = 1/(2\pi\sqrt{LC_p}),$$

is usually too high because the parasitic capacitance (C_p) value is too low. Nevertheless, in (Karalis et al. (2008)) was shown that it is possible to achieve good efficiency with a scheme like the one shown in figure 1(b). For the coupling to surpass the 40% reported in Karalis et al. (2008) the radius (r) for the coil must be much lower than wavelength (λ) of the resonant frequency and the optimum separation (d) for a good coupling should be such $r \ll d \ll \lambda$, in such a way that the coupling is proportional to (Urzhumov & Smith (2011))

$$\frac{r}{\lambda} \frac{r^3}{d^3}.$$

There are two fundamental differences for the simple inductive coupling in figure 1(a), those are: the capacitance of the LC circuit is parasitic, not discrete, and now coils (T y R) are coupled to two one spire coils L_S and L_L , those act as the emitter source and receiver coils, respectively. The coil's self resonant frequency depends of its parasitic capacitance, that is the reason the frequency is very high (around the GHz range). Therefore, to achieve lower self resonance frequency ($< 10\text{Mhz}$) it is necessary to use thick and spaced copper wire to create higher parasitic capacitance, reducing the self resonance frequency down to the megahertz range. In fact, in Karalis et al. (2008) and Kurs (2007) is reported an experiment using cable with 3 cm. radius. The efficiency on the power transfer with respect to the distance has an inverse relationship to the radius of the coil, that is why the experiments reported in Karalis et al. (2008) and Kurs (2007) coils have 30 cm. radius.

3. In figure 1(c), the coupling scheme shown can be named as **modified resonant inductive coupling**, this is a modification for the strong resonant coupling (see figure 1(b)). The modification consists in exchange the parasitic capacitance C_p for a discrete capacitance C . Thus, the need for large and thick cable is eliminated.

4. Experimentation

Triangular and circular coils are going to be employed in order to establish an inductive resonant coupling as shown in figure 1(a) and figure 3.

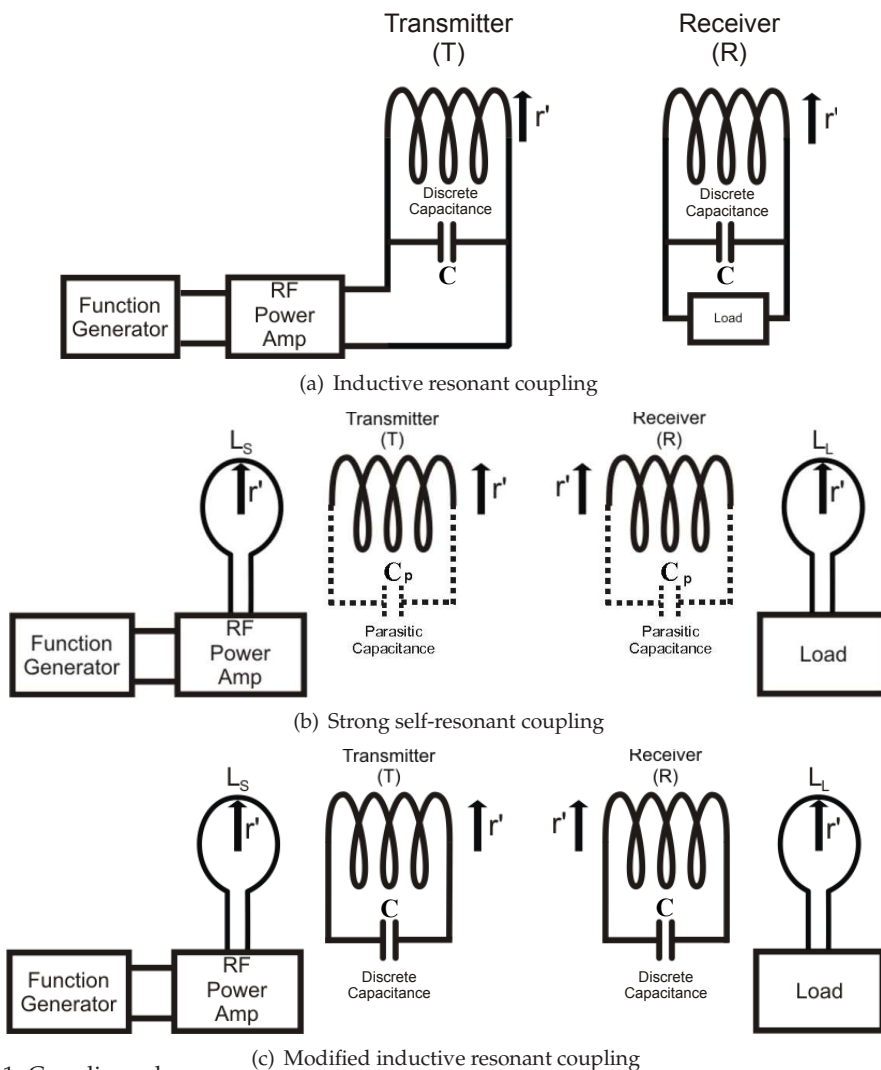

Fig. 1. Coupling schemes

4.1 Inductive resonant coupling at low frequency

This experiment was designed (J.A. Ricaño-Herrera et al. (2010)) to visualize the radiation pattern and the efficiency of an inductive resonant coupling. First, the generating coil was kept in a fixed position while the receiver coil (R) revolves around the generating coil (T), at a fixed distance and with constant angular displacement completing 360 degrees (see figure 2(a)). The experiment shows that the produced energy by the transmitter coil T propagates at 90° in front of the generating coil and at 90° behind the same coil. In another stage of the experiment, two coils were placed in parallel and concentric at a distance of zero centimeters, then they were moved away. The results are shown in figure 2(b). It can be seen from figure

2(c) that the maximum efficiency for voltage gain is around the 50% (at zero centimeters). The result is logical after observing the radiation pattern shown in figure 2(b), because a radiation back lobe is wasted. Figure 2(c) shows, beyond the 8 cm. distance, the voltage gain for the system falls below the 5% value. The back lobe could be reused using a reflecting surface for the magnetic field.

4.2 Comparison between circular and triangular coils at medium frequencies

The phenomenon is well known in mechanics is also present in electricity and is called electrical resonance or inductive resonance

Differences between circular and triangular coils are related to the geometry of the coil, frequency response and radiation pattern. However, these differences produce similar results. The difference in the geometry of coils cause subtle changes in the inductance altering its resonant frequency. Figure 4 was obtained by a S parameter analyser showing several resonant frequencies for the circular and triangular coils. From this figure, the first resonant frequencies can be observed in the range of 21 MHz to 26 MHz for both kind of coils. It is important to recall that just two circular or two triangular coils were used in all experiments to complete the system (figure 1(a) and figure 3).

To determine the working frequency, each pair of coils were tested with a RF generator and a spectrum analyser. Figure 5 shows the frequency sweep for circular coils and figure 6 presents the frequency sweep for triangular coils. The working frequency can be observed between 21 MHz and 27 MHz. This range of frequencies is due to imperfections of coils and not being identical.

Once working frequencies were found for each pair of (circular and triangular) coils, we are ready to initiate the energy transfer experiment. In this experiment, the RF generator was connected to one circular or triangular coil (called Transmitter coil); the spectrum analyser was connected to the other circular or triangular coil (called Receiver coil). Initially, both coils were separated 0 centimetres. After that, one coil was displaced up to 25 centimetres in steps of 1 centimetre. Figure 7 shows the received power for circular and triangular coils in the range from 0 centimetres to 25 centimetres. The frequency distribution (for four distances) is shown in figure 8. In this figure it can be observed that the amplitude, bandwidth and spectral density decrease.

The normalized efficiency for the receiver coil was calculated considering that the maximum power will be always close to 0 centimetres. In this scheme, the efficiency is proportional to the received power (see figure 7 and figure 9). Figure 9 shows the efficiency for circular and triangular coils.

From figures 4, 5, and 6 can be seen that for the same coil system (circular or triangular), several resonance frequencies were obtained, which can be used to transfer power efficiently simultaneously.

The graphical form of the spatial distribution of energy was measured. The radiation pattern for circular and triangular coils is shown in figure 10. It is interesting to observe that, at low frequency figure 7 shows the efficiency decaying as distance increases. This can be explained observing figure 10, it shows for both cases a deformed radiation pattern with respect to the low frequency pattern (see figure 2(b)); at low frequencies the radiation pattern is uniform and has 2 lobes centred on the x axis. Nevertheless, at medium frequencies, the radiation pattern is deformed and has four lobes not centred at x axis. Such lobes are uniformly spaced at 90° from each other, starting at 45° from x axis. This phenomenon explains the fast decay of the

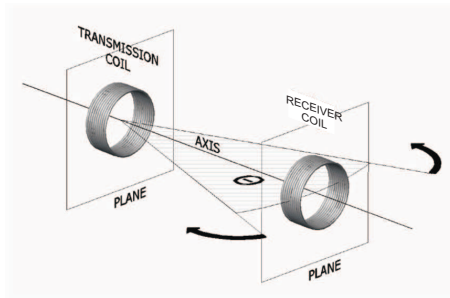

(a) Experimental process for the revolving coil

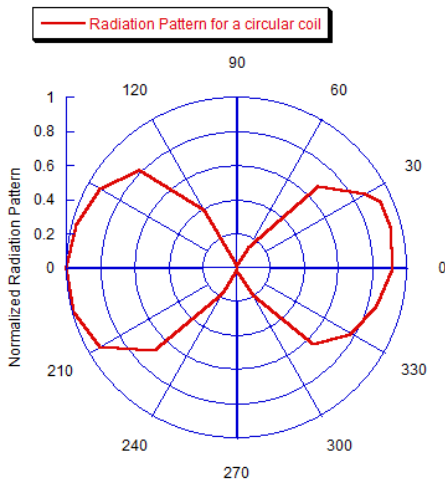

(b) Radiation pattern

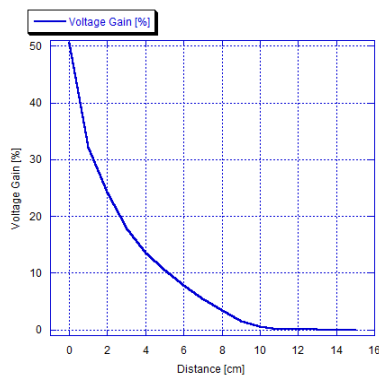

(c) Voltage gain of the system with respect to the voltage ratio

Fig. 2. Generator coil radiation pattern at low frequency (1.4 MHz).

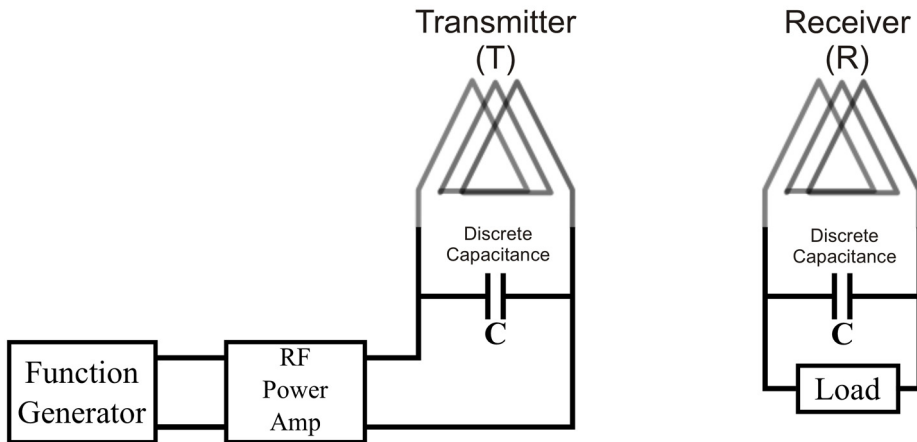

Fig. 3. Triangular coil experiment.

efficiency with respect to the distance shown in figure 7, since coils were placed in a coaxial location, this induced an inefficient coupling, which can be improved turning the emitter coil (A) -45° to make one lobe match the coaxial axis. Also, it is necessary a future research of the radiation pattern shape at higher frequencies, since this work showed the radiation pattern varies as frequency changes for the inductive resonant coupling to achieve more efficiency. This work showed experiments with the coupling scheme shown in figure 1(a) (two coils), which is different from the scheme shown in figure 1(c) (four coils); in scheme 1(c), the single coil L_s generates a radiation pattern, which is coupled to coil T. Coils T and R in this scheme work as lenses concentrating the energy and improving directivity from coil L_s to coil L_l . Analysis at different frequencies of the radiation pattern could show changes in directivity and the existence of several useful resonating frequencies for the strong coupling resonance (figure 1(c)).

5. Philosophy

The wireless energy with: high power ($>100W$), reaching longer distance ($>10m$), having good efficiency ($>70\%$), without health concerns, and low cost is a dream that keeps the attention of researchers around the planet. Nevertheless, in order to make a dream come true it is necessary innovating ideas or even radical ones, to provide the answer for the big questions opposed to achieve the goal. Therefore, innovation is required on the following directions:

- Coils with different geometries. Coils employed on the reported experiments with spirals are circular and triangular. Nevertheless, new geometries (hexagonal, multiform) can be used and thus modify the radiation pattern, this modification on the pattern seeks the increase of: directionality, distance and/or efficiency. With completely different coils, like hexagonal, multiform, highly non-linear radiation patterns could be generated like the ones shown in figure 11.
- Using new materials to improve efficiency. For instance, from the self-resonance coils in experiment 2, it can be achieved using a coil-capacitor device. This coil could be designed

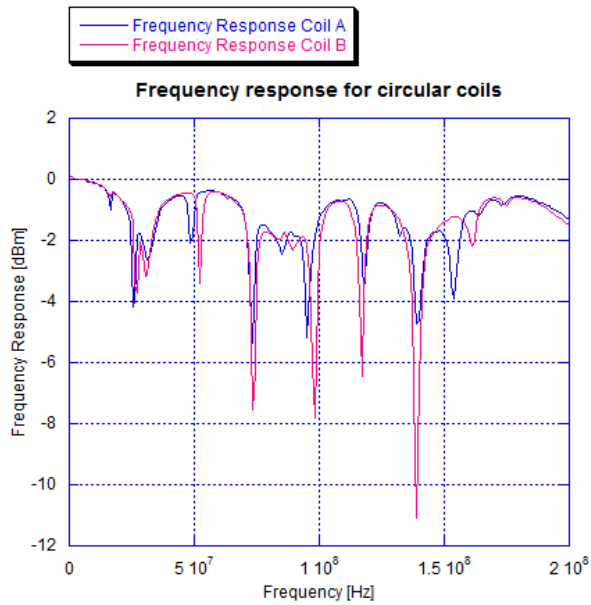

(a)

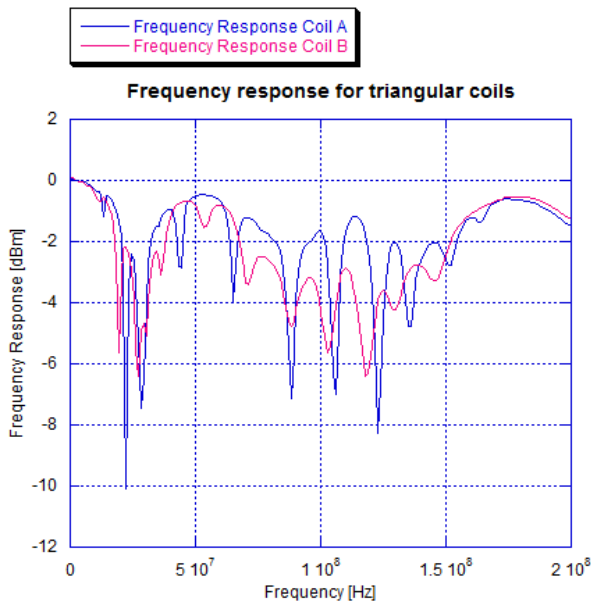

(b)

Fig. 4. Resonant frequencies for (a) circular and (b) triangular coils for frequencies lower than 200 MHz.

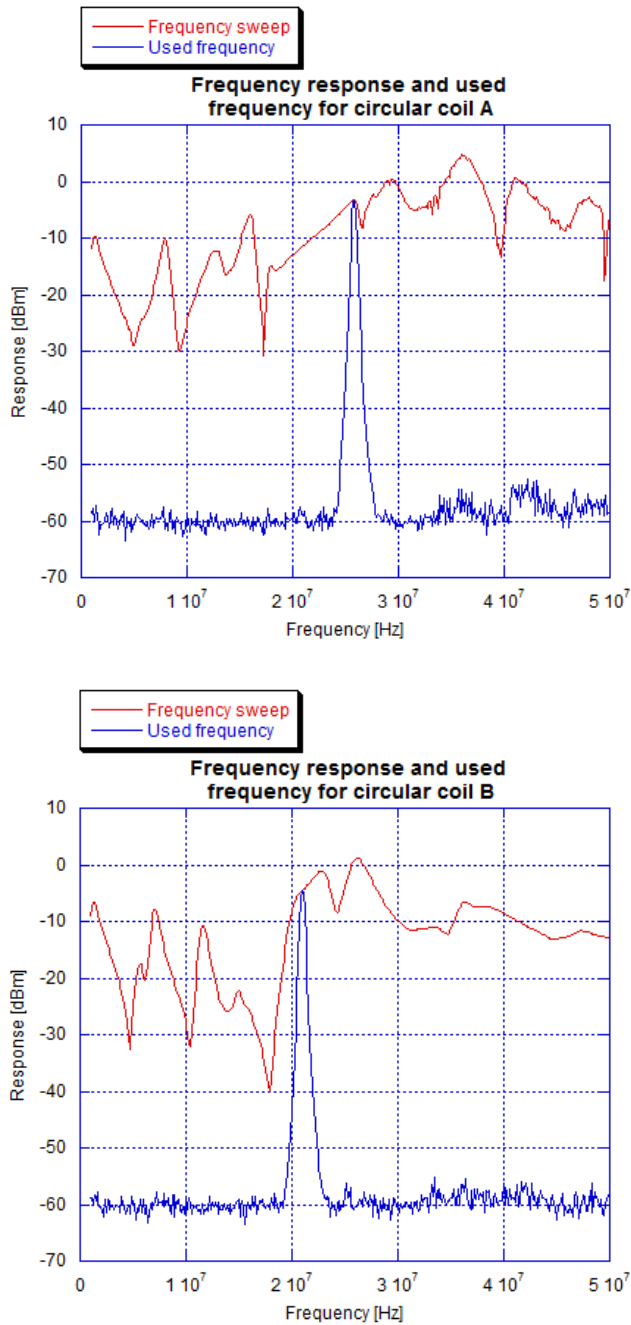

Fig. 5. Frequency sweep and working frequency for a pair of circular coils.

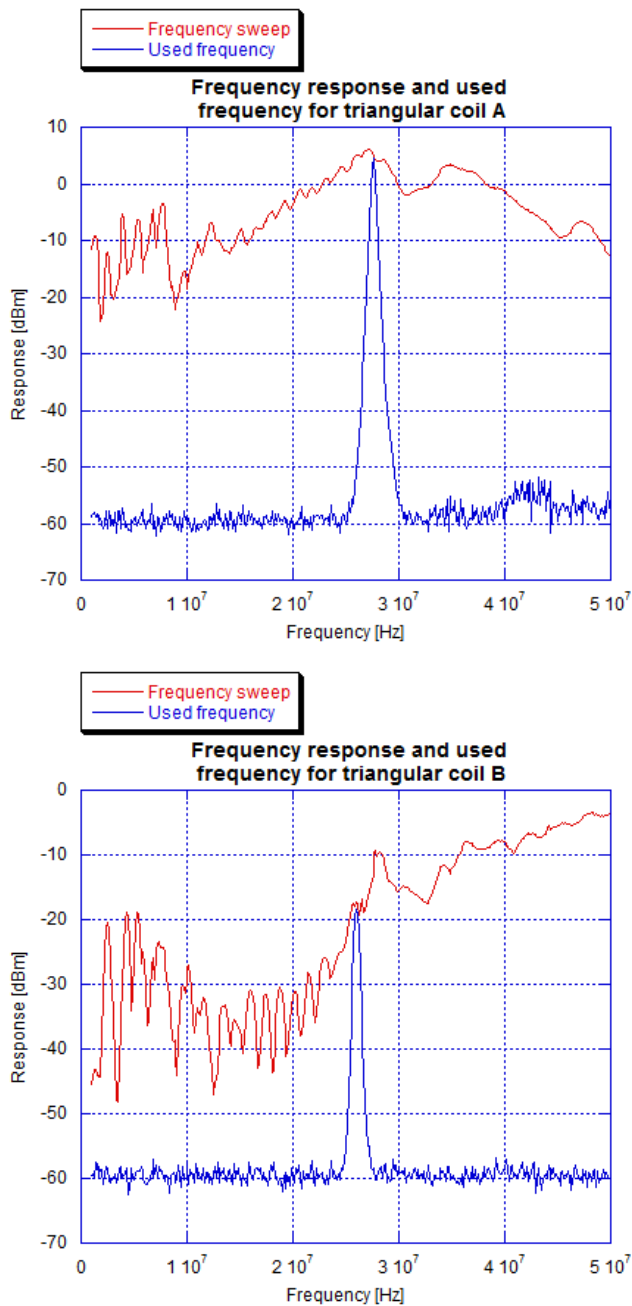
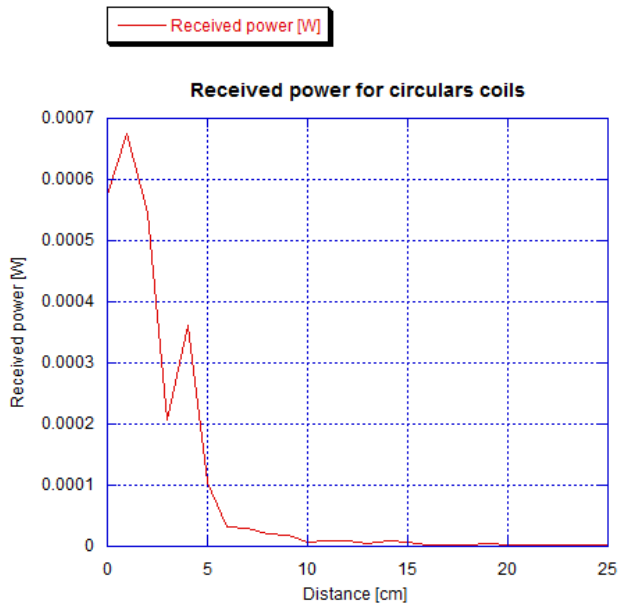
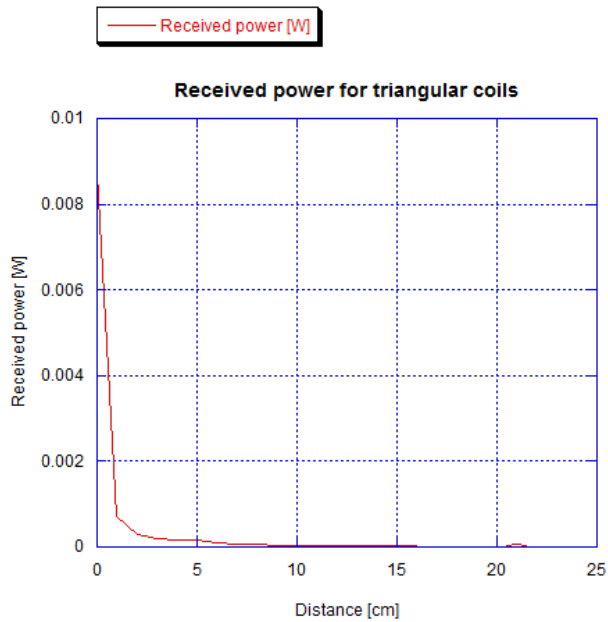

Fig. 6. Frequency sweep and working frequency for a pair of triangular coils.



(a)



(b)

Fig. 7. Received power for (a) circular and (b) triangular coils.

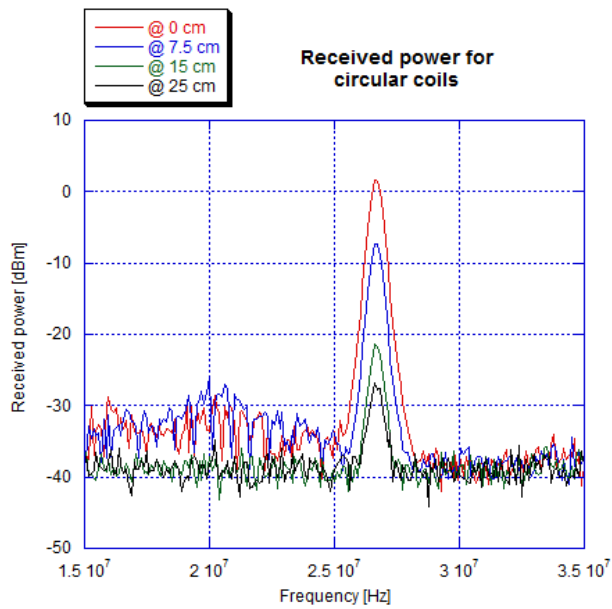

(a)

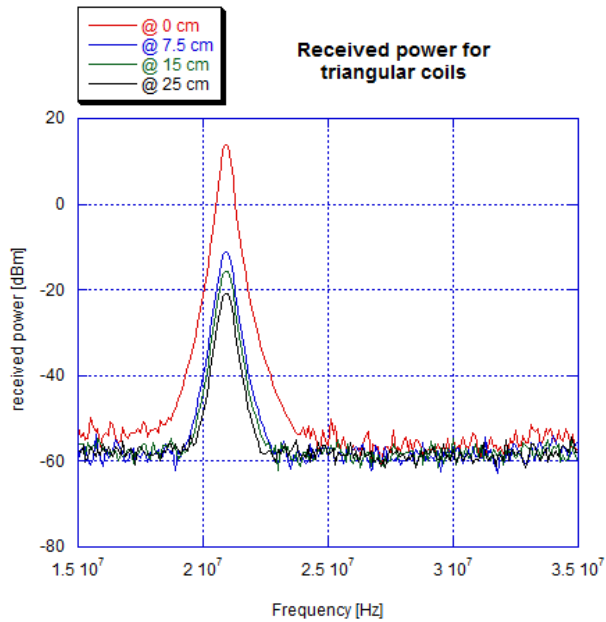

(b)

Fig. 8. Received power for different distances. (a) Circular and (b) triangular coils.

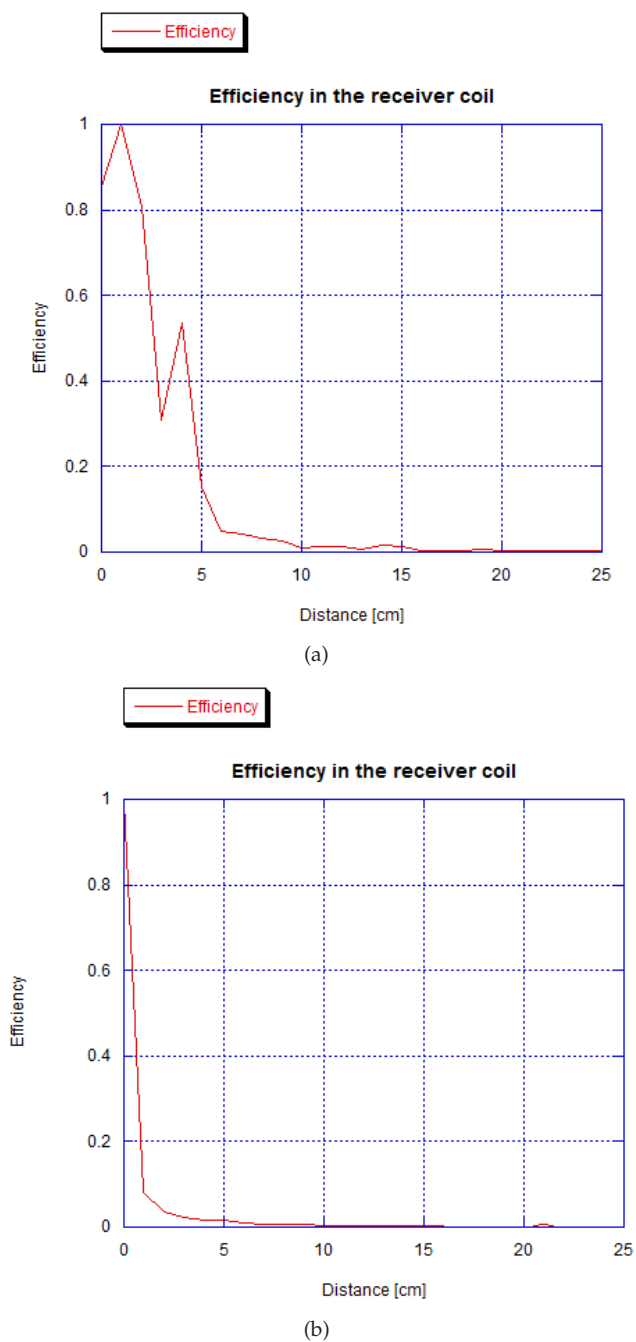

Fig. 9. Normalized efficiency for (a) circular and (b) triangular coils.

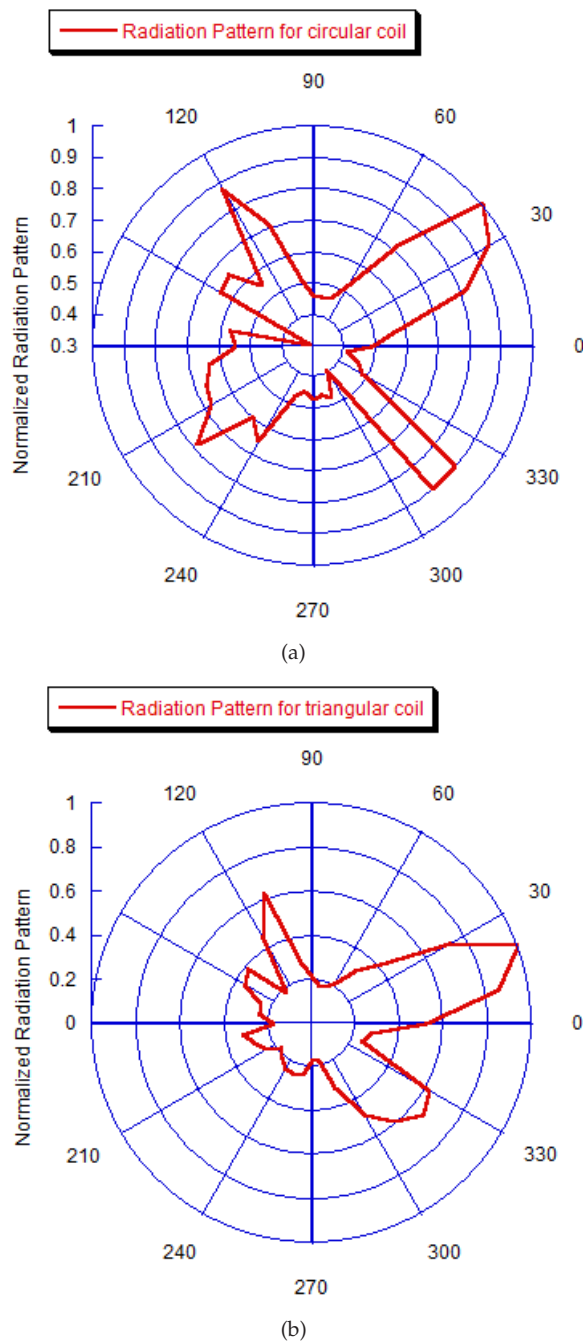

Fig. 10. Radiation pattern for (a) circular and (b) triangular coils.

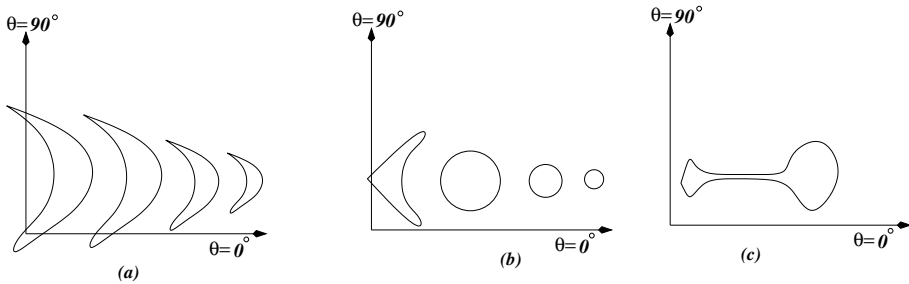

Fig. 11. New radiation patterns.

in such a way that between each spire a dielectric material is placed to create parasitic capacitance along all the coil spires. Therefore, parasitic capacitance will be big enough to achieve self-resonance on the order of MHz. The advantage of this coil-capacitor is that no longer thick coils and spaced spires will be needed.

- In (Urzhumov & Smith (2011) was demonstrated that using metamaterials could improve performance of coupled resonant systems in near field. They proposed a power relay system based on a near-field metamaterial superlens. This is the first step toward optimization of the resonant coupling phenomenon in near field, the next will be the design of coils implemented with metamaterials looking to affect directionality or efficiency.
- Inductive coupled multi-resonant systems. Using amorphous or multiform coils could generate multiple resonant frequencies that could be employed in the transfer of energy using more than one resonant frequency, this will depend on their emitting pattern and efficiency extent. Another possible application for multi-resonant systems is transmission of energy and information at the same time using different channels. For instance, using the information channel to establish the permission for the energy transfer and features like power levels.
- A waveguide designed for the transmitter coil and a reflecting stage in order to use the back lobe of the radiation pattern, may help to improve efficiency of the power transfer.

6. Conclusion

In this work several experiments were performed showing differences and similarities between circular and triangular coils for wireless energy transfer by means of the inductive resonant coupling phenomenon. In particular, showed that the radiation pattern is different for low and middle frequencies. As for low frequencies, two lobes aligned to the x axis were found; for middle frequencies four lobes uniformly spaced but unaligned to the x axis were located. This characteristic deserves deeper study to determine the possibility to use it in order to direct the energy transfer modifying just the resonance frequency. Besides, it was found that the number and position of the resonance frequencies for circular and triangular coils are not similar. This phenomenon could be used to transmit energy or information simultaneously by such resonance frequencies. Also, the efficiency decays exponentially with distance for both geometries, nevertheless, this could be improved taking the advantage of the deforming phenomenon for the radiation pattern at different frequencies.

7. References

- Basset, P., Andreas Kaiser, B. L., Collard, D. & Buchaillet, L. (2007). Complete system for wireless powering and remote control of electrostatic actuators by inductive coupling, *IEEE/ASME Transactions on Mechatronics* 12(1).
- Breckenkamp, J., Gabriele Berg-Beckhoff, E. M., Schuz, J., Schlehofer, B., Warendorft, J. & Blettner, M. (2009). Feasibility of a cohort study on health risks caused by occupational exposure to radiofrequency electromagnetic fields, *BioMed Central Environmental Health*.
- Gao, J. (2007). Traveling magnetic field for homogeneous wireless power transmission, *IEEE Transactions on Power Delivery* 22(1).
- Glaser, P. E. (1973). Method and apparatus for converting solar radiation to electrical power, *U.S.A Patent*.
- Habash, R. W., Elwood, J. M., Krewski, D., Lotz, W. G., McNamee, J. P. & Prato, F. S. (2009). Recent advances in research on radiofrequency fields and health: 2004-2007, *Journal of Toxicology and Environmental Health, Part B* pp. 250–288.
- Hu, H., Hu, Y., Chen, C. & Wang, J. (2008). A system of two piezoelectric transducers and a storage circuit for wireless energy transmission through a thin metal wall, *IEEE Transactions on Ultrasonics, Ferroelectrics, and Frequency Control* 55(10).
- Irgens A, K. K. & M, U. (1999). The effect of male occupational exposure in infertile couples in norway, *J Occup Environ Med.* 41: 1116–20.
- J. A. G. Akkermans, M. C. van Beurden, G. D. & Visser, H. (2005). Analytical models for low-power rectenna design, *IEEE Antennas and Wireless Propagation Letters* 4.
- J.A. Ricaño-Herrera, H. Rodríguez-Torres, H. Vázquez-Leal & A. Gallardo-del-Angel (2010). Experiment about wireless energy transfer, *International Congress on instrumentation and Applied Sciences, CCADET, Cancun, Q.R., Mexico*, pp. 1–10.
- Karalis, A., Joannopoulos, J. & Soljacic, M. (2008). Efficient wireless non-radiative mid-range energy transfer, *Elsevier Annals of Physics* (323): 34–48.
- Kurs, A. (2007). Power transfer through strongly coupled resonances, *Massachusetts Institute of Technology, Master of Science in Physics Thesis*.
- Low, Z. N., Chinga, R. A., Tseng, R. & Lin, J. (2009). Design and test of a high-power high-efficiency loosely coupled planar wireless power transfer system, *IEEE Transactions on Industrial Electronics* 56(5).
- Mansor, H., Halim, M., Mashor, M. & Rahim, M. (2008). Application on wireless power transmission for biomedical implantable organ, *Springer-Verlag Biomed 2008 proceedings 21* pp. 40–43.
- Mohammad Ali, G. Y. & Dougal, R. (2005). A new circularly polarized rectenna for wireless power transmission and data communication, *IEEE Antennas and Wireless Propagation Letters* 4.
- NASA (2003). Beamed laser power for uavs, *Dryden Flight Research Center*.
- Peter A. Valberg, T. E. v. D. & Repacholi, M. H. (2007). Workgroup report: Base stations and wireless network radiofrequency (rf) exposures and health consequences, *Environmental Health Perspectives* 115(3).
- Ren, Y.-J. & Chang, K. (2006). 5.8-ghz circularly polarized dual-diode rectenna and rectenna array for microwave power transmission, *IEEE Transactions on Microwave Theory and Techniques* 54(4).

- Shams, K. M. Z. & Ali, M. (2007). Wireless power transmission to a buried sensor in concrete, *IEEE Sensors Journal* 7(12).
- Tesla, N. (1914). Apparatus for transmitting electrical energy, *USA Patent 1119732* .
- Urzhumov, Y. & Smith, D. R. (2011). Metamaterial-enhanced coupling between magnetic dipoles for efficient wireless power transfer, *Phys. Rev. B* 83(20): 205114–10.
- Valborg Baste, T. R. & Moe, B. E. (2008). Radiofrequency electromagnetic fields; male infertility and sex ratio of offspring, *Springer, European Journal of Environmental Epidemiology* pp. 369–377.

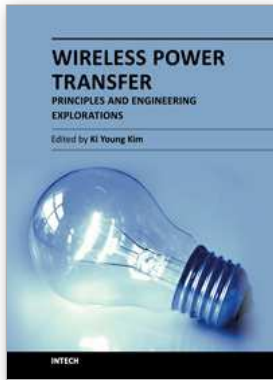

Wireless Power Transfer - Principles and Engineering Explorations

Edited by Dr. Ki Young Kim

ISBN 978-953-307-874-8

Hard cover, 272 pages

Publisher InTech

Published online 25, January, 2012

Published in print edition January, 2012

The title of this book, *Wireless Power Transfer: Principles and Engineering Explorations*, encompasses theory and engineering technology, which are of interest for diverse classes of wireless power transfer. This book is a collection of contemporary research and developments in the area of wireless power transfer technology. It consists of 13 chapters that focus on interesting topics of wireless power links, and several system issues in which analytical methodologies, numerical simulation techniques, measurement techniques and methods, and applicable examples are investigated.

How to reference

In order to correctly reference this scholarly work, feel free to copy and paste the following:

Héctor Vázquez-Leal, Agustín Gallardo-Del-Angel, Roberto Castañeda-Sheissa and Francisco Javier González-Martínez (2012). The Phenomenon of Wireless Energy Transfer: Experiments and Philosophy, *Wireless Power Transfer - Principles and Engineering Explorations*, Dr. Ki Young Kim (Ed.), ISBN: 978-953-307-874-8, InTech, Available from: <http://www.intechopen.com/books/wireless-power-transfer-principles-and-engineering-explorations/the-phenomenon-of-wireless-energy-transfer-experiments-and-philosophy>

INTECH

open science | open minds

InTech Europe

University Campus STeP Ri
Slavka Krautzeka 83/A
51000 Rijeka, Croatia
Phone: +385 (51) 770 447
Fax: +385 (51) 686 166
www.intechopen.com

InTech China

Unit 405, Office Block, Hotel Equatorial Shanghai
No.65, Yan An Road (West), Shanghai, 200040, China
中国上海市延安西路65号上海国际贵都大饭店办公楼405单元
Phone: +86-21-62489820
Fax: +86-21-62489821

© 2012 The Author(s). Licensee IntechOpen. This is an open access article distributed under the terms of the [Creative Commons Attribution 3.0 License](#), which permits unrestricted use, distribution, and reproduction in any medium, provided the original work is properly cited.