

# A Review on Technologies for Reducing CO<sub>2</sub> Emission from Coal Fired Power Plants

S. Moazzem, M.G. Rasul and M.M.K. Khan

*School of Engineering and Built Environment, Faculty of Sciences, Engineering and Health, Central Queensland University, Rockhampton, Queensland Australia*

## 1. Introduction

In recent years, global warming has been a major issue due to continuous growth of greenhouse gas emissions from different sources. It has been estimated that the global average temperature will rise between 1.4 -5.8 °C by the year 2100 (Williams, 2002). The contributors to greenhouse effects are carbon dioxide (CO<sub>2</sub>), chlorofluorocarbons (CFCs), methane (CH<sub>4</sub>), and nitrous oxide (N<sub>2</sub>O). The contribution of each gas to the greenhouse effects is CO<sub>2</sub>- 55%, CFCs - 24%, CH<sub>4</sub> - 15%, and N<sub>2</sub>O - 6% (Demirbas, 2008). Carbon dioxide (CO<sub>2</sub>), a major greenhouse gas which is mainly blamed for global warming occupies a large volume of the total emissions. Figure 1 shows the trend of CO<sub>2</sub> emissions over the years (Demirbas, 2005).

Different industrial processes such as power plants, oil refineries, fertiliser, cement and steel plants are the main contributors of CO<sub>2</sub> emissions. Fossil fuels such as coal, oil and natural gas are the main energy sources of power generation and will continue to generate power due to the large reserves and affordability. It is expected that coal utilisation in power generation will continue to increase in this century too. Demirbas (2005) reported that about 98% of CO<sub>2</sub> emissions result from fossil fuel combustion, and 30%–40% of world CO<sub>2</sub> emissions are generated by coal combustion among all the fossil fuels.

The coal fired power plants generate the majority of the electricity and produce the highest rate of CO<sub>2</sub> per kilowatt hour (Department of Energy and Environmental Protection Agency, Washington DC, 2000). Table 1 shows the CO<sub>2</sub> emissions and power generation from various sources. It can be seen from Table 1 that the coal-fired power plants are responsible for a large percentage of CO<sub>2</sub> emission among other process plants around the world, including Australia. About 46% of the world's power generation is estimated to be from coal combustion, including 50%, 89% and 81% of the electricity generated in the United States, China and India respectively (Parker *et. al.*, 2008). It is estimated that combustion of coal for power generation will be responsible for about 41% of the world's CO<sub>2</sub> emissions by 2025. Table 2 shows the world wide large stationary sources of CO<sub>2</sub> emissions and Figure 2 shows the stationary sources of CO<sub>2</sub> in Australia.

In Australia 75% of the total electricity is produced from coal fired power plants, so coal fired power plants have a great impact on the Australian economy (ESAA, 2003; ABS, 2001). In Australia, power plants contribute about 64% of the total CO<sub>2</sub> emissions generated from stationary sources (AGO, 2006).

Technology	CO <sub>2</sub> Emissions (Kg/MWh)
Pulverised Coal-fired subcritical	850
PC-fired supercritical	800
IGCC	670
NGCC	370
Nuclear	0

Table 1. CO<sub>2</sub> Emissions from Various Power Generation Technologies (Narula *et al.*, 2002)

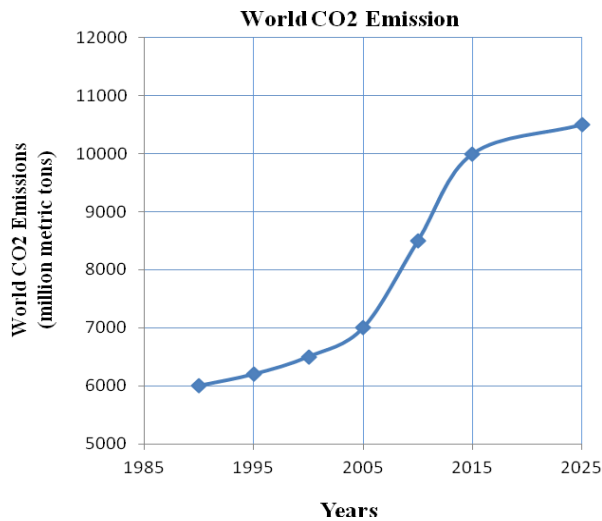

Fig. 1. World CO<sub>2</sub> emissions between 1990 and 2020 (Demirbas, 2005)

Process	Number of sources	Emissions ( MtCO <sub>2</sub> yr <sup>-2</sup> )
Fossil Fuels		
Power	4,942	10,539
Cement production	1,175	932
Refineries	638	798
Iron and steel industry	269	646
Petrochemical industry	470	379
Oil and gas processing	N/A	50
Other sources	90	33
Biomass		
Bioethical and bio energy	3,03	91
Total	7,887	13,466

Table 2. The world wide large stationary sources of CO<sub>2</sub> with emissions (IPCC, 2005)

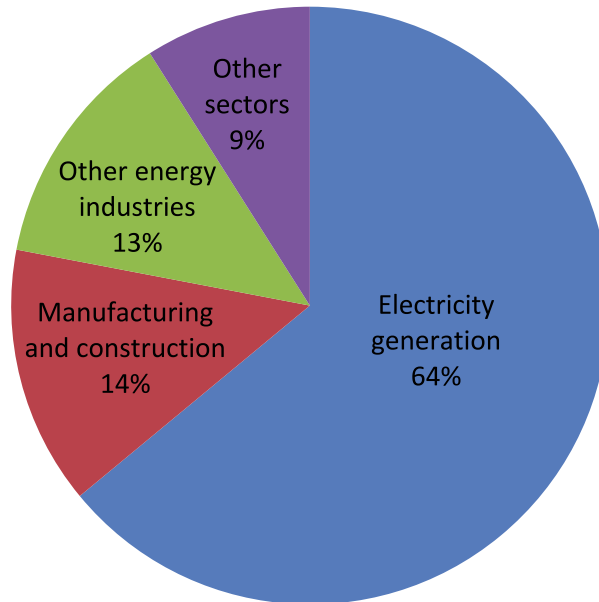

Fig. 2. Stationary sources of CO<sub>2</sub> in Australia (AGO, 2006)

Continued use of coal to produce electricity makes it very important to undertake a study on coal fired power plants with the aim of reducing the hazardous emissions of CO<sub>2</sub> as well as sulphur oxides (SO<sub>x</sub>), nitrogen oxides (NO<sub>x</sub>) and other particulates to help maintain a sustainable environment. As such, it is of great importance to reduce CO<sub>2</sub> in the atmosphere by reducing emissions from power plants.

There are many technologies available to reduce the emissions of sulphur oxides (SO<sub>x</sub>), nitrogen oxides (NO<sub>x</sub>) and other particulates, but very little consideration has been given to the reduction of CO<sub>2</sub> emissions (Coal Industry Advisory Board, 1994). Therefore further study on how to reduce CO<sub>2</sub> emissions from a coal fired power plant is currently an important field of research. Clearly this study on different existing CO<sub>2</sub> emission reduction technologies is needed to identify some measures that could be used for the successful reduction of CO<sub>2</sub> emissions from a typical coal-fired power plant. This chapter aims to identify an appropriate technology of CO<sub>2</sub> emission reduction to maintain sustainable environment.

## 2. Introduction to coal fired power plant

Electricity can be produced by various sources such as fossil fuels, nuclear fission, renewable sources etc. Figure 3 shows a typical schematic diagram of electricity production from burning coal. A typical pulverized coal (PC) combustion power plant is equipped with three units, boiler block, generator block and flue gas clean up block. The boiler block is the main unit where coal is burned with air to generate high pressure steam; the generator block contains the steam turbine/electric generator set, condenser and cooling water; and the third block is the flue gas clean-up unit which removes particulate matter (PM) and other pollutants from the flue gas to control emissions. This third unit carries out Selective Catalytic Reduction (SCR) for NO<sub>x</sub> (Nitrogen Oxide) removal, electrostatic precipitation

(ESP) for particulate matter removal, and wet flue gas desulphurisation (FGD) or wet lime scrubbing to remove SO<sub>x</sub> and mercury. The level of emission control of this unit is 95% – 99% depending on the type of coal used (World Coal Institute, 2010). Narula illustrated that, due to the addition of CO<sub>2</sub> amine scrubbers at the back end of the power plant to reduce CO<sub>2</sub> emissions, the net plant output decreases by about 25 percent from 2 x 400 to 600 MW, and the plant heat rate increases to 13,250 kJ/kWh from 9,800 kJ/kWh, and the capital cost of the plant increases by about 77% (Narula *et al.*, 2002).

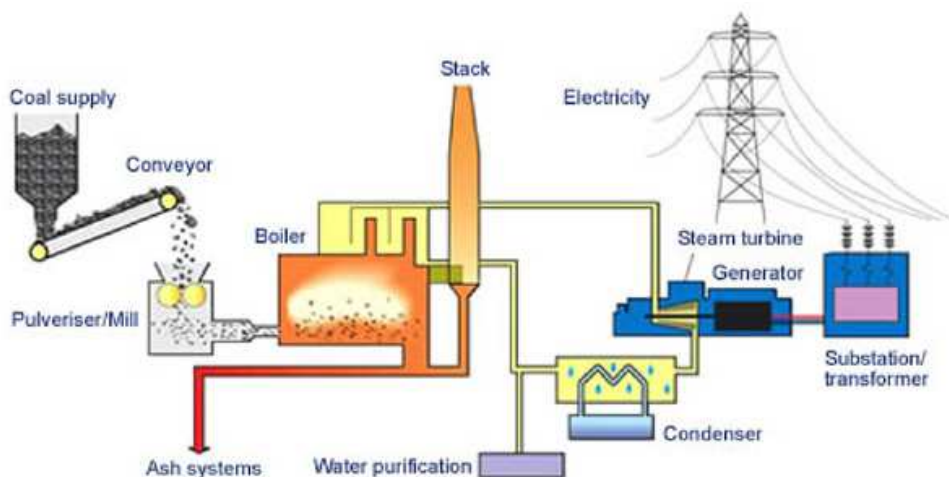

Fig. 3. Diagram of electricity generation from coal (World Coal Institute, 2010)

### 3. Carbon Capture and Storage (CCS) technologies

To prevent major climate change, CO<sub>2</sub> concentration in the atmosphere should be reduced by either CO<sub>2</sub> up-take from the atmosphere biologically or reducing the CO<sub>2</sub> emissions from the sources. There are some approaches available for reduction of CO<sub>2</sub> emissions from stationary sources such as reduction of the consumption of energy generated using fossil fuels, increase in energy generation by non-fossil fuel sources such as solar, wind, biomass, and nuclear energy and using carbon capture and storage (CCS) technology for large scale production. In CCS-technologies, CO<sub>2</sub> is separated from the flue gas from any source and used in other processes or stored in a safe place, such as underground storage and ocean storage. In this study, only reducing/capturing CO<sub>2</sub> from flue gas will be considered among the three phases (capture, transport, storage) of CCS technology.

The idea of separating and storing CO<sub>2</sub> for mitigation of its emissions to the atmosphere was first proposed in 1977 (Marchetti, 1977). Since then a lot of research work has been done on the possible mitigation options. Nowadays there are many CO<sub>2</sub> capture technologies available; some of these technologies are commercially established and some are under development. Mainly there are three pathways (illustrated in Figure 4) to reduce CO<sub>2</sub> emissions, these being post or after combustion, pre or before combustion and oxy-fuel combustion with CO<sub>2</sub>. In pre-combustion processes, CO<sub>2</sub> and other pollutants such as NO<sub>x</sub> and SO<sub>x</sub> are removed through gasification before combustion (Kreutz *et al.*, 2002; Williams,

2003). On the other hand, CO<sub>2</sub> is removed after combustion in post combustion technology. In oxy-fuel combustion, CO<sub>2</sub> is separated during combustion generating a flue gas stream containing mainly CO<sub>2</sub> and H<sub>2</sub>O. This technique is simple and comprises mainly compression and cooling steps and no extra solvents are required (IPCC, 2005). This technology is mainly used in glass, aluminium and steel furnaces to remove CO<sub>2</sub>, but in power generation it is still an emerging technology and some large scale pilot plants are planned or under way.

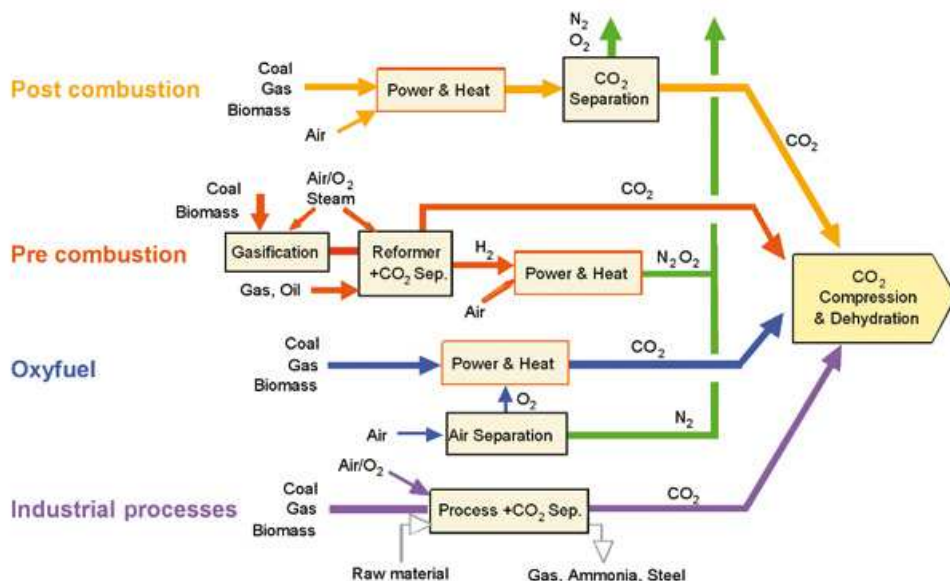

Fig. 4. CO<sub>2</sub> capture technologies (IPCC, 2005)

### 3.1 Pre-combustion CO<sub>2</sub> capture

This process removes the CO<sub>2</sub> from any industrial sources prior to combustion of fuel like coal, oil or gas to produce energy. In the pre-combustion process, fuel is first converted into synthesis gas containing hydrogen and carbon monoxide (CO). This CO reacts with water and produces CO<sub>2</sub>, and finally this CO<sub>2</sub> is separated from the hydrogen and compressed for transportation and storage. Then the remaining hydrogen is combusted to produce energy. About 90%-95% of CO<sub>2</sub> emissions can be reduced by this technology. Pre-combustion technologies are shown in Figures 5. This technology is currently used in oil refineries, but has limited use in power plants. Integrated Gasification Combined Cycle (IGCC) and Fluidized Bed Combustion (FBC) technology are involved in pre-combustion CO<sub>2</sub> capture. Currently, Integrated Gasification Combined-Cycle (IGCC) technology is used to produce electricity and reduce emissions from power plants.

Carbon is captured using IGCC technology before combustion using low pressure with a physical solvent (e.g., Selexol and Rectisol processes), or a chemical solvent (e.g., methyl diethanolamine (MDEA)). In this process, fossil fuel is first converted into CO<sub>2</sub> and Hydrogen gas (H<sub>2</sub>). Then, the H<sub>2</sub> and the CO<sub>2</sub> gas are separated from each other and electricity is produced by the combustion of Hydrogen-rich gas. About 90% of the CO<sub>2</sub> can

be removed from a power plant by pre-combustion CO<sub>2</sub> capture using IGCC technology, though pre-combustion technology is mainly applicable for new power plants, not being economic for existing plants. It was found that currently four commercial IGCC plants (each plant has capacity of 250 MW) are operated worldwide. Power plant efficiency is reduced from 38.4% (without CO<sub>2</sub> capture) to 31.2% (with CO<sub>2</sub> capture) by introducing IGCC technology to reduce emissions (MIT study, Future of coal, 2007).

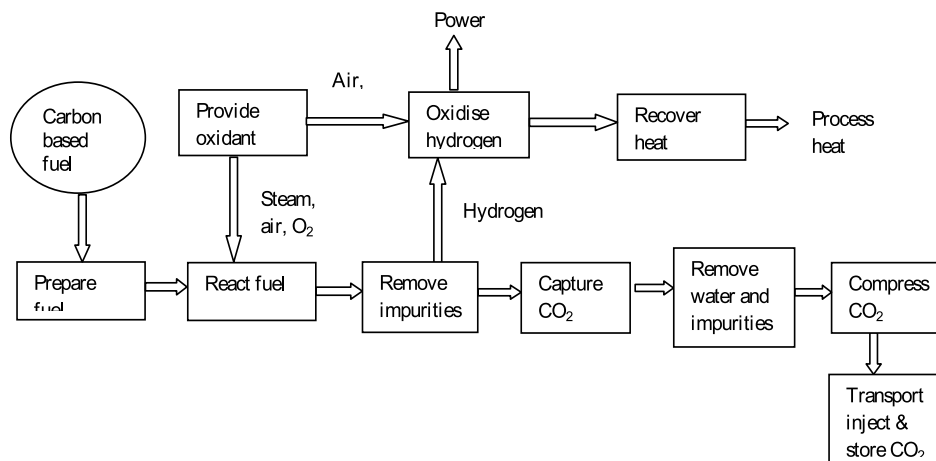

Fig. 5. Simplified illustration (redrawn) of Pre-Combustion CO<sub>2</sub> Capture (Scottish carbon capture and storage, 2010)

### 3.2 During combustion CO<sub>2</sub> capture or oxy-fuel combustion technology

During combustion CO<sub>2</sub> capture involves combustion of the coal with oxygen (nearly pure oxygen >95%) instead of air. A flue gas is produced consisting mainly of highly concentrated CO<sub>2</sub> and water vapour. These two components of flue gas are easily separated through a cooling process. The water is then condensed and a CO<sub>2</sub> rich gas-stream is formed. This oxy-fuel process can remove up to 100 % CO<sub>2</sub> from the flue gas. The oxy-fuel process is illustrated in Figures 6. The main problem of this technology is that separating oxygen from the air causes energy penalty to the power plant. CCS consumes significant amount of energy. This additional energy is supplied from the power generation cycle causing less amount of energy (electricity) output available or demanding additional amount of energy (as input) to generate same amount of energy (electricity) output. This (energy consumed by CCS) is termed as energy penalty and it ultimately raises the cost of power generation. Chemical looping combustion technology which is under development can potentially remove this problem by more easily separating oxygen from the air.

The Vattenfall Project (30MW pilot plant) in Germany and the Callide Oxyfuel Project in Queensland, Australia are the largest oxy-fuel demonstration projects under development. It was estimated by MIT that, after installation of oxy-fuel technology, power plant efficiency will be reduced by 23% for new construction and 31%-40% for retrofitting in an existing plant (MIT study, Future of coal, 2007).

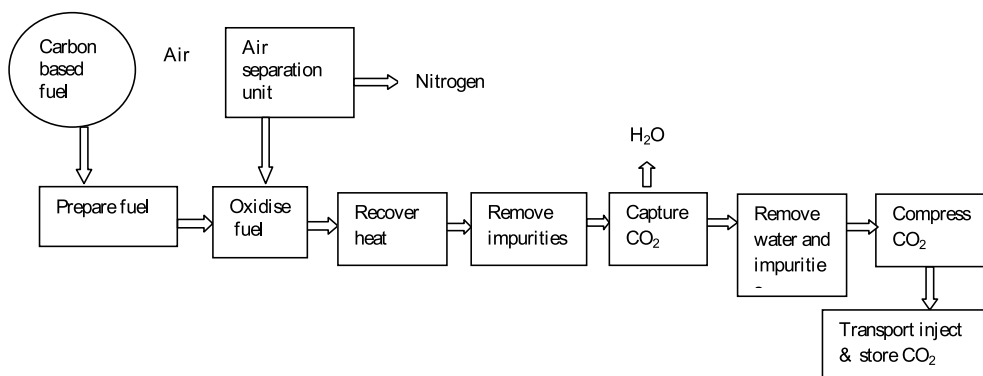

Fig. 6. Simplified illustration (redrawn) of Oxy-Fuel CO<sub>2</sub> Capture (Scottish carbon capture and storage, 2010)

### 3.3 Post-combustion CO<sub>2</sub> capture

Post-combustion CO<sub>2</sub> capture for power plants takes place after combustion of air and fuel to generate electricity, and immediately before the resulting exhaust gas enters the stack. The advantage of post-combustion CO<sub>2</sub> capture technology is that it can be retrofitted to existing plants without major modifications; only the necessary capturing equipment is required to be installed. A simplified illustration of post combustion CO<sub>2</sub> capture is shown in Figure 7. Several post combustion CO<sub>2</sub> capture methods are available. The most common post combustion method is chemical absorption with amine solvents. Other post combustion CO<sub>2</sub> capture technologies are membranes, the PSA (pressure swing adsorption) process and mineral carbonation processes. These are described below.

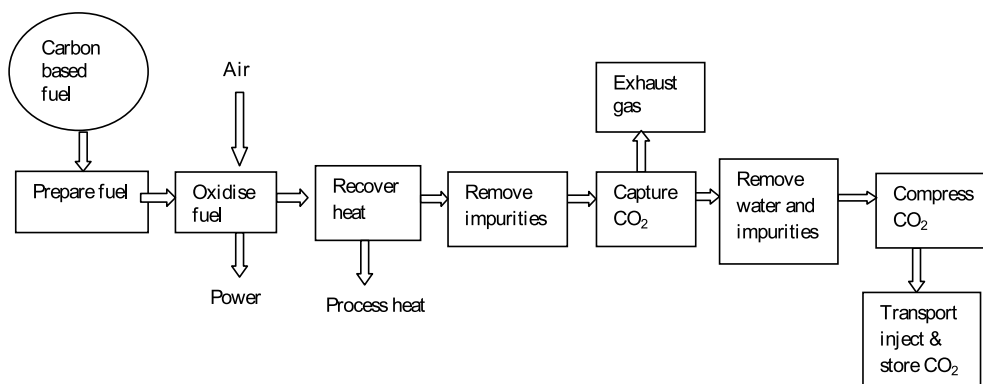

Fig. 7. Simplified illustration (redrawn) of Post Combustion CO<sub>2</sub> Capture (Scottish carbon capture and storage, 2010)

#### 3.3.1 Absorption technology

Up to date the most available and proven capture technology for industrial application is the chemical absorption process using amines (monoethanolamine (MEA)). In this process,

exhaust gases containing  $\text{CO}_2$  pass through an absorber where  $\text{CO}_2$  binds with the MEA solution, and then  $\text{CO}_2$ -rich MEA is pumped to a stripper for regeneration of the solvent and separation of  $\text{CO}_2$  from the MEA. In chemical absorption processes, a chemical bond is formed between gaseous  $\text{CO}_2$  and alkaline solvents and, due to this bond formation, chemical absorption processes are kinetically faster. Many commercial electricity generation plants use a chemical absorption process for  $\text{CO}_2$  recovery (IEA-GHG, 2000). When  $\text{CO}_2$  partial pressure is less than 3.5 bar, then a chemical absorption process is preferred (GPSA, 2004). Figure 8 shows a representation of the chemical absorption process. Flue gas containing  $\text{CO}_2$  is cooled down before entering into the absorber which maintains a temperature range of 40-60° C. In the absorber, flue gas contacts with the absorbing solvent and binds with the absorber. Then the lean flue gas leaves the top of the absorber and rich solvent loaded with  $\text{CO}_2$  leaves the bottom of the absorber and is pumped to the regenerator to recover the solvent through a heat exchanger. In the regeneration section, rich solvent is heated to release  $\text{CO}_2$  from the top of the regenerator and finally  $\text{CO}_2$  is compressed for storage. The lean solvent free of  $\text{CO}_2$  is reused in the absorber (IPCC, 2005).

A physical absorption process is carried out by the weak binding of  $\text{CO}_2$  and the solvent at high pressure. Physical absorption is mainly considered for high  $\text{CO}_2$  concentrations (higher than 15%) and high partial pressures. The physical absorption process is still in the preliminary stages of development. Rectisol, Purisol, Selexol, and Fluor solvents are used for physical absorption, and MDEA, KS-1, KS-2, KS-3, MEA, Amine Guard are used in chemical absorption (International Energy Agency, 2004). Less energy is required for solvent regeneration in the physical absorption process compared to chemical absorption.

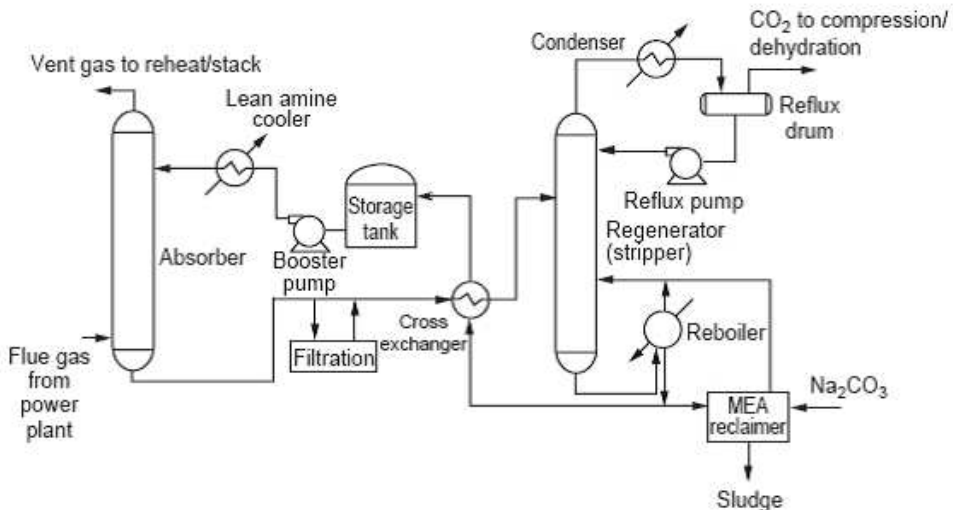

Fig. 8. Amine Chemical Absorption Process (Herzog & Golomb, 2004).

Generally, alkaline solvents such as alkanolamines, hot potassium carbonate, and ammonia are commercially used for  $\text{CO}_2$  recovery. Besides these, amine solvents such as monoethanolamine (MEA), diethanolamine (DEA) and methyl diethanolamine (MDEA) are used in chemical absorption processes. But MEA is the most suitable solvent due to having



some favourable characteristics such as high solubility in water, high biodegradability, high selectivity, fast reaction kinetics, high affinity of CO<sub>2</sub> and being easier to regenerate (DOW, 2005; IPCC, 2005). Hindered-amine solvent KS-1, developed by Mitsubishi Heavy Industries, has lower energy consumption for regeneration (Mimura *et al.*, 1997). Recovery of CO<sub>2</sub> is typically 85% to 95% and CO<sub>2</sub> purity is approximately 99.5% with amines solvents (IPCC 2005). Recently, it has been estimated by MIT that efficiency losses of 25%-28% for new construction and 36%-42% for retrofitting on an existing plant apply as a result of the installation of MEA CO<sub>2</sub> capture technology. In addition, degradation of the amine in the absorber through overheating above 205°F or through oxidation from various causes are other major drawbacks. Flue gas desulphurisation (FGD) or selective catalytic reduction (SCR) devices are required to be installed with the MEA process for removing these drawbacks (Parker *et al.*, 2008). In the chemical absorption process, solvent choice, solvent cooling, heating, regeneration, absorption, pumping and the compression of the purified CO<sub>2</sub> all are energy consuming and costly processes which reduce the overall efficiency of the plant. The absorption column and regeneration unit are both expensive to operate and a high capital investment (Goldthorpe *et al.*, 1992). Therefore, research and developments are needed to improve the energy efficiency, especially in the absorption and regeneration aspects of this technology as well as cooling and heating issues for effective integration of chemical absorption processes into power plants. In addition, choice of solvent is a major factor. The key factors for selection of solvent are heat of absorption/regeneration, CO<sub>2</sub> absorption rate, CO<sub>2</sub> absorption capacity, resistance to degradation and impurities, corrosion, and volatility (Cullinane *et al.*, 2002). The chemical absorption method using MEA is a very expensive and energy intensive process. Binding between CO<sub>2</sub> and solvent molecules is strong and this offers effective removal of most of the CO<sub>2</sub>. But due to this strong binding, high regeneration energy is required to regenerate the solvent.

A chilled ammonia solvent chemical absorption process has been developed in which the flue gas temperature is reduced from about 54.4 °C to 1.6-15 °C before entering the absorber to mitigate oxidation problems. This chilled ammonia process lowers the flue gas temperature which minimises the flue gas volume entering the absorber by condensation of residual water in the gas; this also causes some pollutants in the flue gas to drop out, reducing the need for other upstream control processing, (Parker *et al.*, 2008).

Another ammonia based process designated ECO<sub>2</sub> is being developed by Powerspan. In this process in which does not involve chilling, the higher temperature flue gas is used to increase the CO<sub>2</sub> absorption rate in the absorber to remove CO<sub>2</sub> from flue gas (Powerspan, 2008; Ryan and Donald, 2008). The operation of two commercial demonstration projects of Powerspan's process will start between 2011 and 2012 using a flue gas slipstream equivalent to a 120MW unit from Basin Electric's Antelope Valley Station in North Dakota and a flue gas slipstream equivalent to a 125 MW unit at NRG's W.A. Parish plant in Texas respectively (Parker *et al.*, 2008).

### 3.3.2 Membrane technology

In membrane process gas absorption membranes are used as contacting devices between a gaseous feed stream and a liquid solvent stream. Figure 9 shows a schematic diagram of the membrane process. In this process a membrane module is placed in a thermo water bath to maintain a constant temperature. The feed gas mixture enters the membrane module when the valve of the mixed gas cylinder is turned on to the desired flow rate, and the mixed-gas stream fed into the fibre lumen of the end of the membrane module at a slightly lower pressure than that of the liquid side to prevent dispersion of gas bubbles into the liquid.

The feed gas mixture is prepared in a gas preparation system to a given concentration based on the partial pressure principle, and the absorbents are prepared in the feed tank with deionizer water to a given concentration. The liquid absorbent is introduced by a gear pump from the solution tank to the shell side of the module. Flow of gas steam and liquid absorbent is measured by flow meter. Then CO<sub>2</sub> of the gas mixture is diffused through the membrane pores into the liquid in the shell side and is absorbed by the absorbent. CO<sub>2</sub> permeation through the membrane depends on the difference in partial pressure of the feed side and the permeate side (liquid side) which is known as the pressure ratio (Ho, 2007). Then the liquid absorbent loaded with CO<sub>2</sub> entered into another solution tank, and the treated gas steam is released from the other end of the module (Lu *et al.*, 2009). Selection of solvent and membrane material is very important. In the membrane process, aqueous solutions of propylene carbonate, diethanolamine (DEA), methyldiethanolamine (MDEA) and piperazine (PZ) are used as an aqueous solution. Mainly polymeric membranes, facilitated transport membranes, molecular sieves membranes and palladium based alloy membranes are used in the separation of CO<sub>2</sub> (Feron, 1992).

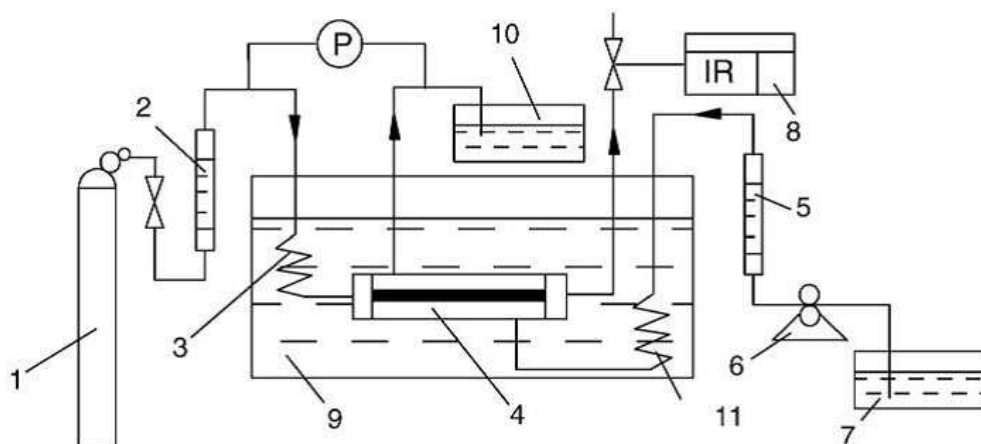

[1 – Mixed-gas cylinder, 2, 5 – flowmeters, 3, 11 – preheater, 4 – membrane contactor, 6 – gear pump, 7, 10 – solution tank, 8 – IR gas analyser, 9 – thermo water bath]

Fig. 9. Schematic diagram of membrane process (Lu *et al.*, 2009)

Aqueous solutions of activated methyldiethanolamine (MDEA) in a PP (polypropylene) hollow fibre membrane contractor showed a better performance in separating CO<sub>2</sub> by the membrane process compared with propylene carbonate with the same membrane contractor (Dindore *et al.*, 2004; Lu *et al.*, 2005). The solvent has low heat of absorption as it requires less energy during regeneration. Another way of improving the chemical absorption process is to ensure that there is maximum interaction between the solvent and the CO<sub>2</sub> (Fei, 2004; Fei and Song, 2005). Other process configurations such as efficient and economic design of absorber, stripper and condenser may be used to improve the process efficiency. Mass transfer coefficient is a very important parameter for the membrane gas process. Mass transfer mainly comprises three steps, diffusion of mixed gas component to the membrane wall, diffusion of the membrane liquid through the pores and finally, dissolution into the liquid absorbent.

Higher operational temperatures and flow rates can enhance the mass transfer coefficient in the absorption membrane process. It also has been observed that a composite amino-acid-based solution (0.75 kmol/m<sup>3</sup> GLY salt) + piperazine (PZ) (0.25 kmol/m<sup>3</sup>) shows better performance than a single amino-acid salt solution, (1.0 kmol/m<sup>3</sup> glycine salt, GLY). CO<sub>2</sub> recovery efficiency of this process is approximately 90% (Lu *et al.*, 2009). The membrane process is a highly energy intensive and costly process because of high equipment cost and the high pressure differential required for this process (Herzog *et al.*, 1991). So technology integration is a major issue to improve the membrane materials, their pore size, selectivity and permeability, and a suitable combination of membrane and liquid solvent has the potential for improvement of the economic aspects of this process. An idea of a hybrid configuration with the membrane process has been proposed (Bhide *et al.*, 1998), where a membrane is used with an existing chemical absorption plant at the front side to remove the bulk of the CO<sub>2</sub> and then an aqueous solution of diethanolamine (DEA) is used to remove the remaining CO<sub>2</sub>.

### 3.3.3 PSA (Pressure Swing Adsorption) technology

The diagram of the Pressure Swing Adsorption (PSA) system is shown in Figure 10. The basic principle of the PSA cycle was described by Skarstrom (1960). In the PSA process, high pressure mixed feed gas is fed into the absorber. Then gas with a high affinity to the adsorbent is absorbed, and the gas with lower affinity passes through the bed and accumulates at another closed end. When the absorber bed is saturated with high affinity gas, then the outlet valve of the absorber bed is opened and low affinity gas is withdrawn. The pressure of the adsorber bed is reduced as a result, and the absorbed gas is released from the adsorber bed. Finally, the evacuation of the absorbed gas is completed by pumping from the adsorber bed. This step may include the purging of the adsorber bed with low affinity gas (Skarstrom, 1960; Ho, 2007)

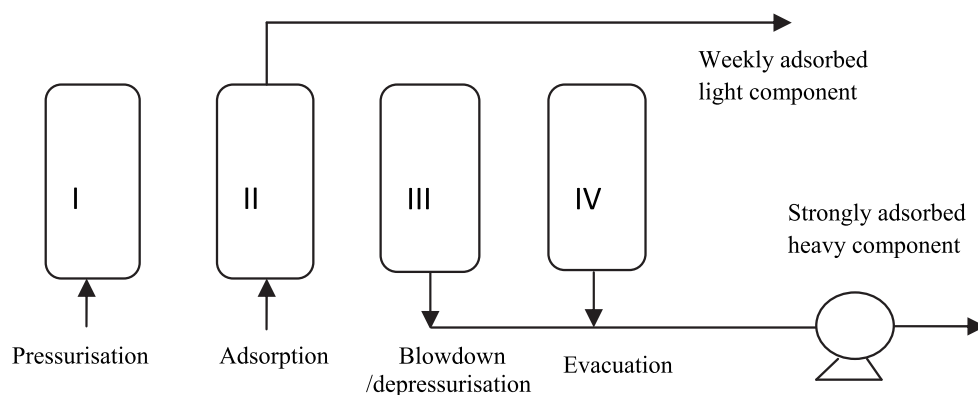

Fig. 10. Schematic diagram of PSA process (Skarstrom, 1960; Ho, 2007)

In Pressure Swing Adsorption (PSA) systems, one of the most important parameters is the choice of the adsorbent for gas adsorption. Adsorbents with high surface areas such as zeolite, molecular sieves and activated carbon have been widely analysed for their CO<sub>2</sub>

separation effectiveness. It has been evaluated that zeolite 13X is a better adsorbent for  $\text{CO}_2$  as it has higher working capacity, lower purge requirements and higher equilibrium selectivity than activated carbon (Chue *et al.*, 1995). In PSA processes, mainly zeolite 13X is used as the adsorbent. Currently it is used in steel and lime industries to reduce  $\text{CO}_2$  from flue steams.

### 3.3.4 Mineral carbonation technology

In mineral carbonation  $\text{CO}_2$  comes from different sources react with calcium (Ca) or magnesium (Mg) based natural silicate minerals and form naturally stable solid carbonated product. The storage capacity of this carbonated product is very large compared to other storage options. The carbonated products are stored at an environmentally suitable location or reuse in another industrial process such as mine reclamation and construction, also can be reused and disposal for land filling. It was found from literature that mineral carbonation technology is still in the research and development stage and further research is required to demonstrate and implement this process in power plant (IPCC, 2005). Carbonation of metal oxide bearing minerals with atmospheric  $\text{CO}_2$  is a natural process that occurs spontaneously at low partial pressure and at ambient temperature, though this natural process is relatively slows. Based on this natural process subsequent researches are continuing to accelerate the reaction process to introduce this technology in an industrial scale. The idea of  $\text{CO}_2$  sequestration by mineral carbonation is relatively new. It was first proposed in 1990 (Seifritz, 1990) and the first published study on this idea was 1995 by Lackner (Lackner *et al.*, 1995). In this process gaseous  $\text{CO}_2$  is converted into geologically stable carbonates. Figure 11 shows the schematic diagram of the carbonation process.

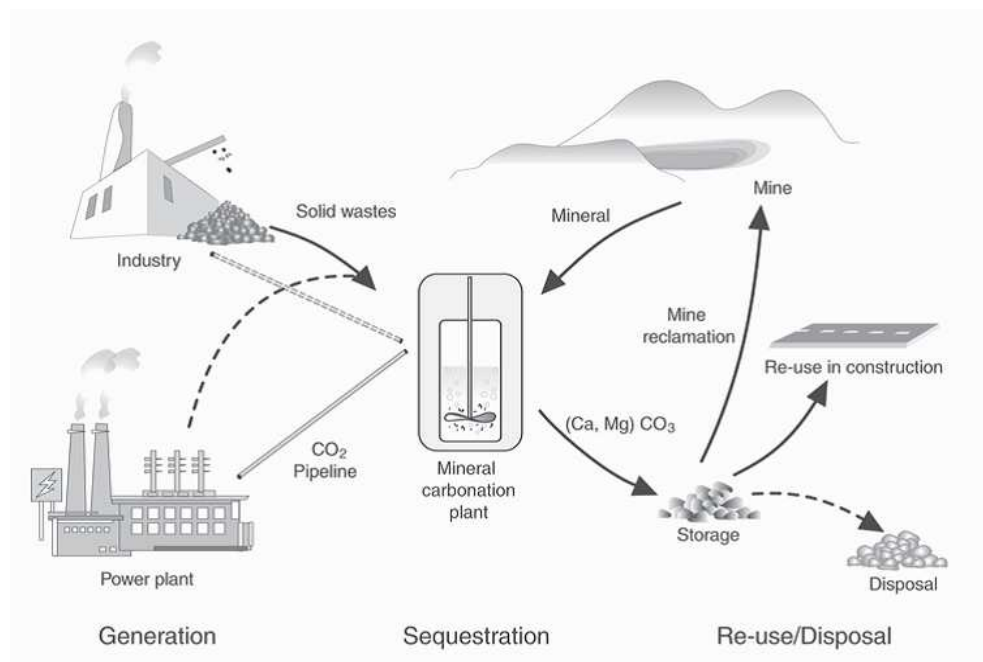

Fig. 11. Schematic drawing of a mineral  $\text{CO}_2$  sequestration process (Kojima *et al.*, 1997).

The simple chemical equation of this process is demonstrated below (Lackner *et al.*, 1995),

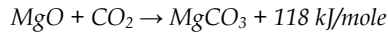
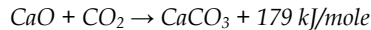

Figure 12 shows the flow diagram of mineral carbonation process with serpentine and olivine. In this diagram carbonation is carried out after different pre-treatment options such as crushing, grinding, magnetic separation and heat treatment. Size reduction of the mineral particle by crushing and grinding is essential to get a specific particle size for carbonation reaction. Iron ore ( $\text{Fe}_3\text{O}_4$ ) and  $\text{H}_2\text{O}$  are separated from the mineral through magnetic separation step and heat treatment step respectively. Then this pre-treated mineral mix with water to form slurry. Carbonation reaction of this mineral slurry with compressed  $\text{CO}_2$  is carried out in a carbonation reactor. After carbonation  $\text{CO}_2$  and  $\text{H}_2\text{O}$  is recycled back to the reactor and carbonated product and by product is separated.

In recent years a lot of researches have been performed related to the different pathways of carbonation technology that can significantly reduce the emissions of  $\text{CO}_2$  into the atmosphere from any carbon burning processes.

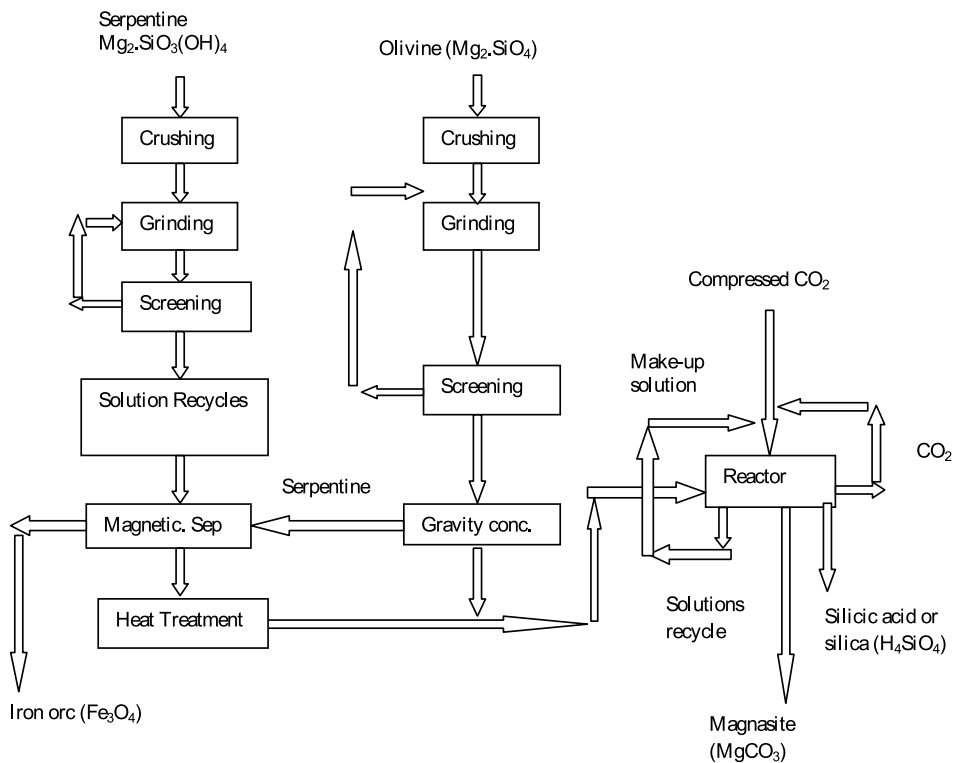

Fig. 12. Process flow diagram (redrawn) of carbonation process for magnesium silicate (O'Connor *et al.*, 2001)

Currently CO<sub>2</sub> capture processes are commercially used in the petroleum and petrochemical industries, but integration of CO<sub>2</sub> capture, transport and storage has not been demonstrated in a power plant yet, though several research and development programs have been demonstrated worldwide for power plants (IPCC, 2005). The status of different CCS technologies is given in Table 3.

CCS Component	CCS Technology	Research Phase	Demonstration phase	Economically feasible under specific conditions	Mature market
Capture	Post combustion			X	
	Pre combustion			X	
	Oxy-fuel combustion		X		
	Industrial separation (natural gas processing, ammonia production)				X
Transportation	Pipe line				X
	Shipping			X	
Geologic storage	Enhanced oil recovery (EOR)				X
	Gas or oil fields			X	
	Saline formations			X	
	Enhanced coal based methane recovery (ECBM)		X		
Ocean storage	Direct injection (dissolution type)	X			
	Direct injection (lake type)	X			
Mineral carbonation	Natural silicate minerals	X			
	Waste materials		X		
Industrial uses of CO <sub>2</sub>					X

Table 3. Status of CO<sub>2</sub> capture and storage technology (IPCC, 2005)

It is clearly seen from Table 3 that mineral carbonation is still in research and development phase. Further study is essential. More in-depth review on mineral carbonation is presented in the following section.

## 4. Details of carbonation technologies

### 4.1 Routes or pathways of carbonation reaction

The carbonation reaction is carried out in two ways: direct routes and indirect routes. In direct routes carbonation takes place in a single step process, a gas-solid or a gas-liquid-solid

process, and in indirect routes extraction of Ca/Mg occurs from the mineral and then carbonation takes place in an another step where silicates are directly carbonated in an aqueous medium at elevated temperature and CO<sub>2</sub> pressure (Huijgen, 2007). The detailed of pathways of carbonation reaction are described below.

#### 4.1.1 Direct carbonation

##### 4.1.1.1 Direct gas solid carbonation routes or dry carbonation

This process route with Ca/Mg-Silicates has some advantage for its direct reaction, simple process design, exothermic energy generated by the carbonation reaction that can be utilized in another process and no extra solvent is required to enhance the reaction (Lackner *et al.*, 1995; Huijgen, 2007). Figure 13 shows the direct gas solid carbonation process flowchart. Basic chemical reaction of this process is given below,

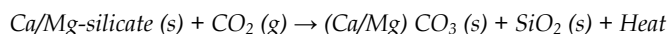

for instance in the case of olivine:

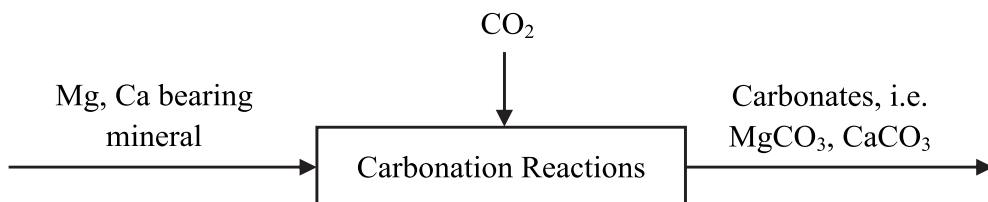
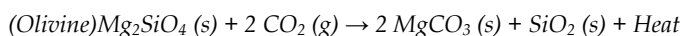

Fig. 13. Direct gas-solid carbonation process flowchart

Direct dry carbonation process occurs quite slowly at room temperatures and process can be accelerated by increasing the temperature to a certain degree (Lackner *et al.*, 1995). (Prigiobbe *et al.*, 2009) conducted carbonation tests of CO<sub>2</sub> with calcium rich fly-ash and found that the maximum conversions are occurred at 400°C temperatures or above 400°C. It was found from the test that the quickest carbonation ( $t_{50\%} = 31$  seconds) is occurred at 400°C with CO<sub>2</sub> occupying 50% of the flue gas and the maximum conversion (78.9%) occurred at 450°C with CO<sub>2</sub> occupying 10% of the flue gas. Though this process can result in high exothermic heat effect, but it is very energy-consuming due to the activation process of the mineral by heat treatment to enhance the carbonation rate significantly (Zevenhoven & Kohlmann, 2002). The reactant feed stocks are required to grind sufficiently to increase the surface area before carbonation reaction to ensure the effectiveness of the direct carbonation route.

##### 4.1.1.2 Direct carbonation: Direct aqueous carbonation

According to the principle of carbonation process in natural weathering, the presence of water can enhance the carbonation reaction rate. Direct aqueous carbonation route has been developed based on the natural process of carbonation, as natural carbonation process is

enhanced in presence of water (O'Connor *et al.*, 2000). Figure 14 shows the flow chart of direct aqueous carbonation process. The most attractive and promising route of carbonation is direct aqueous carbonation. A few solvents, such as sodium hydrogen carbonate ( $\text{NaHCO}_3$ ), sodium chloride ( $\text{NaCl}$ ), mg-acetate and water can be used as reaction medium to enhance the carbonation process. The purpose of this additive is to increase the dissolution and carbonation rate (Krevor, 2009; O'Connor *et al.*, 2005). This solvent can increase the carbonation process than direct dry carbonation process.

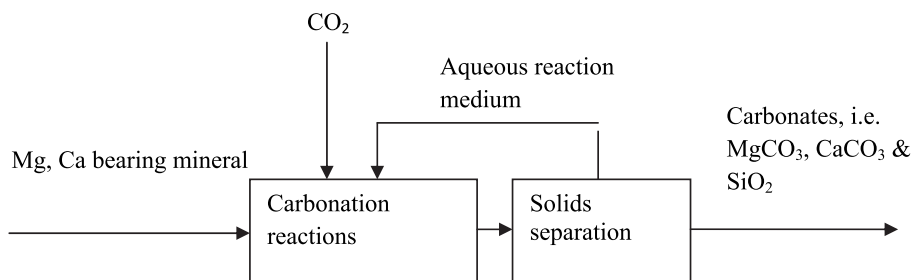
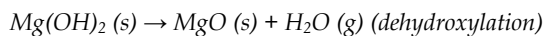

Fig. 14. Flow chart of direct aqueous carbonation process

Carbonation reaction can be increased by increasing the specific surface area, reducing  $(\text{Ca}, \text{Mg})^{2+}$ -activity in solution and removing the  $\text{SiO}_2$ -layer. Addition of  $\text{NaCl}$ ,  $\text{NaHCO}_3$ , and  $(\text{Na}/\text{K})\text{NO}_3$  can reduce the  $(\text{Ca}, \text{Mg})^{2+}$ -activity in solution and increase the ionic strength. Addition of  $\text{HCl}$ , acetic acid, and citric acid can increase the reaction rate. In the case of serpentine, orthophosphoric acid, oxalic acid and EDTA can also increase the reaction rate (Park *et al.*, 2003).

#### 4.1.2 Indirect carbonation: Cg/Mg-hydroxides carbonation or aqueous acid carbonation

The Cg/Mg -Hydroxides Carbonation or Indirect Carbonation or Aqueous Acid Carbonation essentially uses an aqueous solution to extract the magnesium and calcium content from the mineral prior to the actual carbonation process and the original mineral is split into smaller components, as a result carbonation take places at a much faster and favorable rate (Lackner *et al.*, 1995). Figure 15 shows the flowchart of aqueous acid carbonation process. Carbonation of Ca/Mg-Hydroxides or Indirect carbonation is considered as a feasible and faster process than carbonation of Ca/Mg-silicates, but high temperature and high  $\text{CO}_2$  pressure are required for optimum conversion of mineral. It has been observed that  $500^\circ\text{C}$  and 340 bar  $\text{CO}_2$  is required for  $\text{Mg}(\text{OH})_2$  carbonation for 100% conversion within two hour (Lackner *et al.*, 1997). The chemical reaction of the carbonation of  $\text{Mg}(\text{OH})_2$  is shown below,



The activation energy of the combined carbonation and dehydroxylation reaction are 304 kJ/mol and the optimum temperature for the reaction is  $375^\circ\text{C}$  which is thermodynamically



favourable (Butt *et al.*, 1996; Huijgen, 2007). Though, Ca/Mg-hydroxides are not available in nature, but Ca/Mg-hydroxides can be found by the conversion of Ca/Mg-Silicates using extraction agent (Lackner, 1995; Huijgen, 2007).

Depending on the mineral and characteristics of the overall process, various acids, bases or water such as hydrochloric acid, caustic soda, sulphuric acid or steam can be added at various stages to extract the Ca/Mg components from the magnesium/calcium bearing mineral. Due to the losses of the extraction agent throughout the process hydrochloric acid is perhaps a preferred choice due to its relatively low cost. Recovery of the extraction agent at the end of the extraction process is essential for the overall feasibility of aqueous acid carbonation process (Lackner *et al.*, 1995). Literature indicates that several extraction agents can be used to extract Ca/ Mg component from mineral such as, HCl, molten salt (MgCl<sub>2</sub>.3.5H<sub>2</sub>O) and acetic acid.

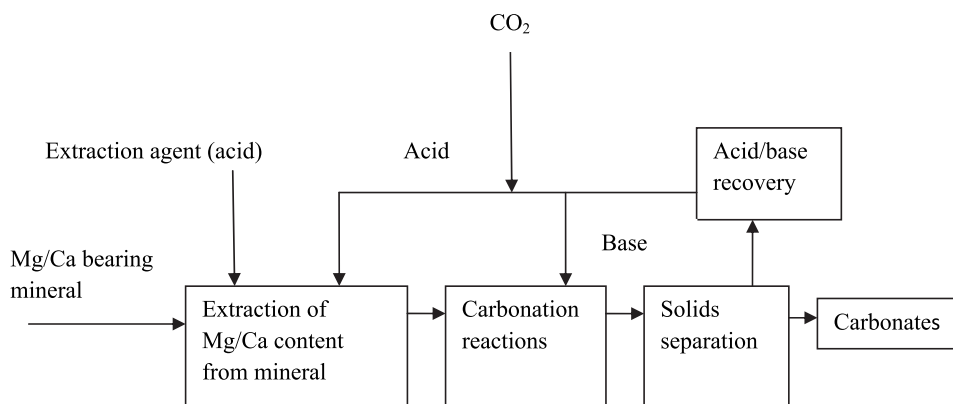

Fig. 15. Flowchart of aqueous acid carbonation process

#### 4.2 Materials for carbonation

Mineral CO<sub>2</sub> sequestration requires large amounts of Ca/Mg minerals for large-scale sequestration of CO<sub>2</sub> from flue gases. For example 1 kg of CO<sub>2</sub> may require 2 kg (or more) of serpentine for the carbonation reaction, which may cause a significant environmental impact due to the disposal problem (Sipila *et al.*, 2007). About 10,000 tons of CO<sub>2</sub>/day is produced from a single 500 MW power station. To sequester this large amount of CO<sub>2</sub> through the carbonation process, approximately 23,000 tons/day of magnesium silicate ore is required (Lackner *et al.*, 1995). Different types of materials can be used for the carbonation process such as mineral rocks and industrial residues. Calcium and magnesium oxides and hydroxides are the ideal materials for carbonation, but they are not available in nature. Alkaline mineral materials are available and abundant in natural silicate rocks around the world that contain high amounts of magnesium, calcium and also low amounts of iron, sodium and potassium.

Table 4 shows the composition of some selected rocks and pure minerals and their potential CO<sub>2</sub> sequestration capacity. Industrial residues such as slag from steel production, fly ash from coal combustion, de-inking ash from recycling of paper and municipal residue can also be used for mineral carbonation to minimise CO<sub>2</sub> emissions (IPCC, 2005; Johnson, 2000).

These industrial residues are a valuable source of Ca/Mg, therefore industrial residues can be applied to carbonation processes to minimise CO<sub>2</sub> emissions. This has a great

Rock mineral	MgO[wt%]	CaO[wt%]	RCO <sub>2</sub> [kg/kg] <sup>a</sup>
Serpentine	~40	~0	~2.3
Serpentine, Mg <sub>3</sub> Si <sub>2</sub> O <sub>5</sub> (OH) <sub>4</sub>	48.6		1.9
Dunite	49.5	0.3	1.8
Olivine, Mg <sub>2</sub> SiO <sub>4</sub>	57.3		1.6
Wollastonite	0.8	43.7	2.9
Wollastonite, CaSiO <sub>3</sub>		48.3	2.6
Talc	34.7	0.0	2.6
Talc: Mg <sub>3</sub> Si <sub>4</sub> O <sub>10</sub> (OH) <sub>2</sub>	31.9		2.9
Basalt	6.2	9.4	7.1

a, RCO<sub>2</sub> = mass ratio of rock to CO<sub>2</sub> required for CO<sub>2</sub> sequestration

Table 4. Composition of some selected rocks and pure minerals and their potential CO<sub>2</sub> sequestration capacity (Huijgen, 2007)

environmental benefit, as these residues are disposed of easily and cost effectively by reusing them in carbonation technology. Table 5 shows different studies on carbonation of industrial residues, described below. Industrial residues have some potential benefit compared to mineral materials as they are readily available and cheap, and also utilising these residues in carbonation processes has a positive impact on the environment. Besides this, due to chemical instability, industrial residues are highly reactive in nature.

Residue	Details of carbonation process	T [°C]	P <sub>CO2</sub> [bar]	d [mm]
Blast furnace slag		25	3	NA <sup>a</sup>
Cement-immobilised slag	Supercritical CO <sub>2</sub>	50	250	
Coal fly ash	Aqueous route <sup>b</sup>	185	115	NA
Coal fly ash	20% moisture	25	2.8	<0.25
De-inking ash		25	3	NA
FBC coal ash	Aqueous route <sup>b</sup>	155	75	NA
FGD coal ash	Aqueous route <sup>b</sup>	185	115	NA
MSWI ash		25	3	NA
MSWI bottom ash	Water content: moisture.	20	60(l)	<10
		40	150(sc)	
		50	250(sc)	
OPC cement		25	3	NA
Portland cement pastes	W/c: 0.6	59	97	NA
Pulverised fuel ash	Water:solid 0.1 - 0.2	25	3	NA
Spent oil shale	20% moisture	25	2.8	<0.25
Stainless steel slag		25	3	NA
Waste Dravo-Lime	Aqueous route <sup>b</sup>	185	115	NA

<sup>a</sup> Not available. <sup>b</sup> Additives used: 0.5M Na<sub>2</sub>CO<sub>3</sub> / 0.5M NaHCO<sub>3</sub> / 1.0M NaCl.

Table 5. Different studies on carbonation of residues with process condition (Huijgen, 2007)

### 4.3 Pre-treatment before carbonation

Mineral carbonation requires some pre-processing of minerals such as grinding, heat treatment and magnetite separation, and also the CO<sub>2</sub> pressure should be similar to the pressure of the pipeline if CO<sub>2</sub> is piped to the disposal site (O'Connor *et al.*, 2001). Before carbonation, CO<sub>2</sub> is preheated typically between 100°C and 150°C, especially for aqueous carbonation processes where the carbonation occurs between 300°C to 500°C (Butt *et al.*, 1996). Mineral treatment with steam or acid or a combination of these can be applied to increase the specific surface area of a mineral to improve the carbonation rate (O'Connor *et al.*, 2001). Carbonation has been successfully performed after such activation, heat treatment, grinding and magnetite separation.

Mineral and carbonation reaction	T <sub>deh</sub> k	T <sub>max</sub> K	ΔH kJ/mole	ΔQ kJ/mole
Calcium Oxide CaO + CO <sub>2</sub> → CaCO <sub>3</sub>	-	1161	-167	87
Magnesium Oxide MgO + CO <sub>2</sub> → MgCO <sub>3</sub>	-	680	-115	34
Calcium Hydroxide Ca(OH) <sub>2</sub> + CO <sub>2</sub> → CaCO <sub>3</sub> + H <sub>2</sub> O	791	1161	-68	114
Magnesium Hydroxide Mg(OH) <sub>2</sub> + CO <sub>2</sub> → MgCO <sub>3</sub> + H <sub>2</sub> O	538	680	-37	46
Wollastonite CaSiO <sub>3</sub> + CO <sub>2</sub> → CaCO <sub>3</sub> + SiO <sub>2</sub>	-	554	-87	37
Clinoenstatite (Pyroxene) MgSiO <sub>3</sub> + CO <sub>2</sub> → MgCO <sub>3</sub> + SiO <sub>2</sub>	-	474	-81	23
Forsterite (Olivine) 1/2Mg <sub>2</sub> SiO <sub>4</sub> + CO <sub>2</sub> → MgCO <sub>3</sub> + 1/2SiO <sub>2</sub>	-	515	-88	24
Diopside (Pyroxene) 1/2CaMg(SiO <sub>3</sub> ) <sub>2</sub> + CO <sub>2</sub> → 1/2CaCO <sub>3</sub> + 1/2MgCO <sub>3</sub> + SiO <sub>2</sub>	-	437	-71	19
Grossular (Garnet) 1/3Ca <sub>3</sub> Al <sub>2</sub> Si <sub>3</sub> O <sub>12</sub> + CO <sub>2</sub> → CaCO <sub>3</sub> + 1/3Al <sub>2</sub> O <sub>3</sub> + SiO <sub>2</sub>	-	465	-65	28
Anorthite (Feldspar) CaAl <sub>2</sub> Si <sub>2</sub> O <sub>8</sub> + CO <sub>2</sub> → CaCO <sub>3</sub> + Al <sub>2</sub> O <sub>3</sub> + 2SiO <sub>2</sub>	-	438	-81	39
Anorthite Glass CaAl <sub>2</sub> Si <sub>2</sub> O <sub>8</sub> + CO <sub>2</sub> → CaCO <sub>3</sub> + Al <sub>2</sub> O <sub>3</sub> + 2SiO <sub>2</sub>	-	691	-148	121
Pyrope (Garnet) 1/3Mg <sub>3</sub> Al <sub>2</sub> Si <sub>3</sub> O <sub>12</sub> + CO <sub>2</sub> → MgCO <sub>3</sub> + 1/3 Al <sub>2</sub> O <sub>3</sub> + SiO <sub>2</sub>	-	533	-92	40
Talc 1/3Mg <sub>3</sub> Si <sub>4</sub> O <sub>10</sub> (OH) <sub>2</sub> + CO <sub>2</sub> → MgCO <sub>3</sub> + 4/3SiO <sub>2</sub> + 1/3H <sub>2</sub> O	712	474	-44	64
Tremolite (Amphibole) 1/7Ca <sub>2</sub> Mg <sub>5</sub> Si <sub>8</sub> O <sub>22</sub> (OH) <sub>2</sub> + CO <sub>2</sub> → 2/7 CaCO <sub>3</sub> + 5/7MgCO <sub>3</sub> + 8/7 SiO <sub>2</sub> + 1/7H <sub>2</sub> O	839	437	-37	72
Chrysotile (Serpentine) 1/3Mg <sub>3</sub> Si <sub>2</sub> O <sub>5</sub> (OH) <sub>4</sub> + CO <sub>2</sub> → MgCO <sub>3</sub> + 2/3SiO <sub>2</sub> + 3H <sub>2</sub> O	808	680	-35	78

[NOTES:

T<sub>max</sub>, is the maximum carbonation temperature for PCO<sub>2</sub> = 1 bar.

T<sub>deh</sub> refers to the dehydroxylation temperature,

The enthalpy of reaction, ΔH(T<sub>max</sub>), is normalised to one mole of CO<sub>2</sub>

The heat ΔQ is the energy required to heat the original mineral and CO<sub>2</sub> to the higher of T<sub>max</sub> and T<sub>deh</sub>, normalised to one mole of CO<sub>2</sub>.

The initial temperature is assumed to be 298K.] (Lackner *et al.*, 1995)

Table 6. Thermodynamic properties of carbonation reactions (Lackner *et al.*, 1995)

Particle size is a vital factor for determining carbonation reaction rates, as carbonation reactions are mainly surface controlled. Particles with coarser sizes can be used, but smaller particle sizes are preferred for carbonation reaction. Particle sizes < 37 microns are preferred for optimum reaction. Particle size can be reduced through grinding and crushing. An increase from 10 to 90% carbonation conversion can be achieved by reducing the particle size from 106-150  $\mu\text{m}$  to <37  $\mu\text{m}$  (O'Connor *et al.*, 2000).

Before carbonation heat treatment is required to remove chemically bound water and activates the mineral for carbonation process. It was roughly estimated that the optimum energy requirements for heat treatment is 200 kWh/ton for serpentine at 600- 650°C it was found that the specific surface area of antigorite is increased from 8.5 to 18.7  $\text{m}^2/\text{g}$  by heat treatment to accelerated the reaction(O'Connor *et al.*, 2001). Heat treat process generates steam which is also a potential recoverable energy. Magnetic separation step is mainly used for serpentine to remove the magnetite ( $\text{Fe}_3\text{O}_4$ ) that is remaining naturally with the serpentine. Magnetic is a useful by-product.

The natural process of mineral carbonation is very slow at ambient temperatures. It has been evaluated that carbonation reaction rates can be increased by increasing the temperature and pressure (Lackner *et al.*, 1995; Zevenhoven & Kohlmann, 2002). The maximum allowable carbonation temperature should be maintained during carbonation reaction according to the nature of the mineral and the  $\text{CO}_2$  pressure. Above this temperature, carbonation reactions are not thermodynamically feasible. Table 6 shows the thermodynamic properties of various carbonation reactions.

As carbonation reaction is exothermic, carbonated product can be obtained at low temperature. Above 900°C for calcium carbonate and above 300°C for magnesium carbonate with  $\text{CO}_2$  partial pressure of one bar the carbonation reaction can be reversed that is called calcinations (IPCC 2005; Nikulshina *et al.*, 2007).

#### 4.4 Energy consumption and exothermic nature of carbonation processes

Carbonation processes require energy intensive preparation of the solid reactants including pre-treatment, mining, transportation, grinding and activation to achieve the required conversion, and power plant efficiency can be reduced by this. Power plants' efficiency can be reduced by up to 20 percent for  $\text{CO}_2$  capturing processes (Plasynski and Chen, 2000), though chemical reaction of the mineral carbonation process is exothermic. If suitable energy recovery options are implemented, then operating efficiency of those power plants will be raised using the exothermic energy and energy recovered from the product. The wet carbonation of the natural silicate olivine causes a 30-50% energy penalty on the power plant, and to implement a CCS system in such power plants, 60-180% more energy is required to reduce  $\text{CO}_2$  emission while maintaining equivalent power output (IPCC, 2005). It is estimated that efficiency is reduced 27% by implementing mineral  $\text{CO}_2$  sequestration technology in power plants and 75% of the total efficiency reduction is caused by grinding. Energy cost can be reduced by using the exothermic nature of the reaction and also utilising the by-products of the carbonation reaction. Furthermore, reuse of the resulting products could enhance the economic return (Huijgen, 2007).

It was estimated that total costs of  $\text{CO}_2$  capture by mineral carbonation are about 90-120 €/ton $\text{CO}_2$  which is very high for large scale  $\text{CO}_2$  capture by mineral carbonation technology,

though it was observed that costs can be reduced using the exothermic nature of the carbonation reaction and also utilising the valuable by-product of mineral mining such as magnesium, silicon, chromium, nickel and manganese and the reusing of carbonated product (Huijgen & Comans, 2003). Some possibilities for energy integration by exothermic reaction of carbonation technology have been identified using Aspen Plus modelling software. These are listed in Table 7 below (Brent and Petrie, 2008)

Energy Sinks	Energy Sources
Mineral comminution energy CO <sub>2</sub> compression duty Serpentine activation Carbonation reagent slurry preheating	Compressed CO <sub>2</sub> product stream Dehydroxylation reaction products Carbonation reaction products

Table 7. Possible Energy sinks and energy sources (Brent and Petrie, 2008)

## 5. CCS projects in Australia

Currently, several carbon capture and storage (CCS) projects are running around across the world including Australia. Some CCS projects in Australia are detailed below,

### 5.1 Zero Gen Project

Stanwell Corporation (owned by the Queensland Government) proposes to build a 100 MW Integrated Gasification Combined Cycle (IGCC) plant with capture technology adjacent to the existing Stanwell Power Station, 29 kilometres west of Rockhampton. The ZeroGen project will integrate IGCC technologies with Carbon Capture and Storage (CCS) to produce low-emission base load electricity. The project will convert pulverised coal into a synthesis gas (consisting mainly of hydrogen and carbon monoxide) through the IGCC process with a mixture of oxygen enriched air and steam under pressure. The “syngas” then undergoes a shift conversion in a gasifier where the carbon monoxide is converted to hydrogen and carbon dioxide. The CO<sub>2</sub> is then separated from the shifted “syngas” and produces a clean, low-carbon, high-hydrogen fuel to produce electricity. The estimated project cost is A\$4.3 billion. It is expected that this will have the potential to capture up to 90% of CO<sub>2</sub> emissions for full sequestration. Japan-based Mitsubishi Corporation (MC) and Mitsubishi Heavy Industries (MHI) will provide IGCC and carbon capture technology for the power plant. The proposed plant will be operational in 2015 (Zero Gen Project, 2008).

### 5.2 Callide Oxyfuel Project

The Callide Oxyfuel Project is located at Biloela in Queensland and aims to capture carbon using oxyfuel combustion, combined with carbon storage. In this technology, coal is combusted in a boiler with oxygen and then exhaust gases have been recycled instead of regular air. The project is lead by CS Energy Ltd with international partners IHI Corporation (Japan), J-Power (Japan), Mitsui & Company (Japan), Schlumberger Oilfields Australia and Xstrata Coal. Financial support for this project is provided by the Australian Coal Association and the Commonwealth, Queensland and Japanese governments. Stage one of the project involves the conversion of a generator to apply oxyfuel combustion and the capture of CO<sub>2</sub>. Stage two of the project will see the ‘transport, injection and storage of liquefied CO<sub>2</sub> in deep geological formations’. The Callide Oxyfuel project will retrofit the 30

MW generators at the Callide “A” pulverised coal power station near Biloela in Queensland to allow oxyfuel combustion (Callide Oxyfuel Project, 2008).

### 5.3 Delta-Munmorah Post Combustion Capture (PCC) Project

Delta-Munmorah PCC Project, run by the CSIRO with Delta Electricity, is based on post-combustion (where CO<sub>2</sub> is captured after combustion) CO<sub>2</sub> capture at an ammonia based pilot plant built at the Munmorah Power Station on the New South Wales Central Coast. This pilot plant research project began in February 2009 and will continue until 2013. This project is also supported by the Australian Government (National Research Flagships, CSIRO, 2009).

### 5.4 Wandoan Power Project

The Wandoan Power Project will integrate Gasification Combined Cycle (IGCC) pre-combustion carbon capture and storage technologies. In IGCC process fossil fuel is first converted into CO<sub>2</sub> and Hydrogen gas (H<sub>2</sub>). Then CO<sub>2</sub> gas is separated and electricity is produced by the combustion of Hydrogen-rich gas. This project is led by GE energy, with partners Stanwell Corporation and Xstrata Coal. This project is located near Wandoan in Queensland’s Surat Basin and will build a 400MW IGCC power plant with carbon capture and storage capacity of 90% of CO<sub>2</sub> emissions (Flagship Project: Wandoan Project).

### 5.5 Project on mineral carbonation at NSW

Recently a joint venture project between Green Mag Group and the University of Newcastle, Australia has been established with an aim to set a carbonation plant at Newcastle, Australia using serpentine that is abundant in Australia. In this study, the efficacy and prospect of carbonation technology (Mineral carbonation project for NSW) will be investigated and evaluated.

## 6. Comparison of CCS technologies

As mentioned earlier, there are many CO<sub>2</sub> capture technologies available to mitigate CO<sub>2</sub> emissions such as chemical absorption, pressure swing adsorption (PSA), gas separation membranes and cryogenic separation. It can be noted that implementation of any CCS technology will introduce extra cost and energy penalty. So cost and energy penalty should be considered before implementation of CCS technology in power plant. Different technologies are compared with their advantages and disadvantages in Table 8.

Technology	Advantage	Disadvantage
Chemical Absorption Technology	<ul style="list-style-type: none"> <li>• Technically mature</li> <li>• Suitable for low concentration of gas stream</li> <li>• Solvent can be regenerated</li> <li>• Purity of the CO<sub>2</sub> stream up to 95%</li> </ul>	<ul style="list-style-type: none"> <li>• High energy is required for solvent regeneration and also high capital cost associated with absorber and stripper section</li> <li>• Large amount of solvent is required to capture CO<sub>2</sub></li> <li>• Up to 20% to 30% energy is required for CO<sub>2</sub> capture process through chemical</li> </ul>

Technology	Advantage	Disadvantage
		<p>absorption out of the total output energy of a 500 MW power plant</p> <ul style="list-style-type: none"> <li>• Absorption capacity of solvent is limited</li> </ul>
Physical Absorption Technology	<ul style="list-style-type: none"> <li>• Technically mature and common processing equipment is used</li> <li>• Less energy is required to regenerate the solvent compared to chemical absorption</li> <li>• Flue gas containing NO<sub>x</sub>, O<sub>2</sub> and CO can pass through the physical absorption process as they do not degrade the solvent due to their low solubility in the physical solvent</li> </ul>	<ul style="list-style-type: none"> <li>• Physical solvent is costly</li> <li>• Suitable only for high pressure gas streams</li> <li>• High capital cost due to absorber, stripper and solvent</li> </ul>
Membrane Technology	<ul style="list-style-type: none"> <li>• Suited to high pressure gas streams with low concentrations</li> </ul>	<ul style="list-style-type: none"> <li>• Technically immature</li> <li>• Energy intensive</li> <li>• High equipment cost due to compressors, membrane housing, membrane filters</li> <li>• High pressure differential is required between two phase</li> </ul>
Adsorption Process	<ul style="list-style-type: none"> <li>• Suitable for low concentration streams</li> </ul>	<ul style="list-style-type: none"> <li>• High energy consumption and high capital cost for adsorbed bed and sorbents</li> <li>• Low efficient</li> </ul>
Low Temperature Systems	<ul style="list-style-type: none"> <li>• Most suitable for binary gas streams</li> <li>• CO<sub>2</sub> product is ready for transport as CO<sub>2</sub> is separated in liquid form so there is no requirement for compression before transport</li> <li>• Separated CO<sub>2</sub> stream purity relatively high</li> </ul>	<ul style="list-style-type: none"> <li>• Energy and cost intensive due to refrigeration and distillation units</li> <li>• Efficiency affected by other gas components in flue stream</li> <li>• Traces elements of flue gases (such as methane or water vapour) should be required to be removed before cryogenic separation (Ho, 2007)</li> </ul>
Mineral Carbonation Technology	<ul style="list-style-type: none"> <li>• Availability of feedstock</li> <li>• Exothermic nature</li> <li>• Valuable by-product</li> </ul>	<ul style="list-style-type: none"> <li>• Energy consuming process, especially for pre-treatment</li> </ul>

(Ho, 2007).

Table 8. Comparison of different CO<sub>2</sub> capture technologies

After a careful consideration of the advantages and disadvantages of existing CO<sub>2</sub> removal technologies, it can be said that mineral carbonation technology is a potentially viable CO<sub>2</sub> reduction technology for a power plant, mainly due to its exothermic nature which can be integrated with other energy consuming requirements of the plant provided a suitable energy recovery process is applied in the power plant. This technology is relatively new and promising, and still in the research phase. So further research on carbonation technology is required because of the following advantages compared to other technologies:

- Carbonated products are environmentally safe and stable over geological time frames.
- Raw materials for mineral carbonation exist in vast quantities across the world.
- Carbonation processes are exothermic.
- Carbonation reactions produce value-added carbonated products which have some valuable uses such as mine reclamation, construction or other prospective applications.
- Carbonation reaction and mining of mineral produce some valuable by products such as chromium, nickel, magnesium, silicon, and manganese which have valuable market use.
- This mitigation option is feasible where underground reservoirs and ocean storage of CO<sub>2</sub> is not possible.

## 7. Conclusions

It can be concluded that the improvement of cost and energy penalty associated by carbonation technology can be achieved through integration of exothermic energy produced from the carbonation reaction, energy recovered from product of carbonation reaction for self sustaining system and utilizing the carbonated product and by-product. Another prospect of this technology is utilizing the industrial waste as a feed stock to make this process less expensive. Any other CCS technologies have not these promising prospects. There are studies available on acceleration of the carbonation processes related to the reaction kinetics, but there is very limited information related to the integration of the carbonation processes into power plants, and the performance of the power plants associated with this process. To integrate carbonation processes into coal fired power plants, research should be done to assess the performance of these processes to introduce this technology at an affordable rate with reduced energy penalties to power plants. The outcome of the study may contribute to the savings of process energy, hence decreasing processing costs and increasing capital gain.

## 8. References

- ABS, (2001). Energy and greenhouse gas emissions accounts, Australia, Australian Bureau of Statistics, Canberra, Report No. 4604.
- AGO, (2006). National Greenhouse Gas Inventory, Australian Greenhouse Office, Canberra. (Available at [www.greenhouseoffice.gov.au](http://www.greenhouseoffice.gov.au))
- Bhide, B. D., Voskericyan, A. and Stern, S. A. (1998). Hybrid processes for the removal of acid gases from natural gases, *Journal of Membrane Science*, (140), 27-49.
- Brent, G. F. and Petrie, J.G. (2008). CO<sub>2</sub> sequestration by mineral carbonation in the Australian context, Chemeca 2008: Towards a Sustainable Australasia.



- Butt, D.P., Lackner, K.S., Wendt, C.H., Conzone, S.D., Kung, H., Lu, Y.-C. & Bremser, J.K. (1996). Kinetics of thermal dehydroxylation and carbonation of magnesium hydroxide, *Journal of American Ceramic Society* 79(7), 1892-1898.
- Callide oxy fuel project, viewed at 18 July, 2010.  
<http://www.callideoxyfuel.com/Why/OxyfuelTechnology/tabid/72/Default.aspx>
- Coal Industry Advisory Board. (1994). Industry attitudes to combined cycle clean coal technologies survey of current status, Organization for Economic Co-operation and Development / International Energy Agency, France.
- Chue, K. T., Kim, J. N., Yoo, Y. J., Cho, S. H. and Yang, R. T. (1995). Comparison of activated carbon and zeolite 13X for CO<sub>2</sub> recovery from flue gas by pressure swing adsorption, *Industrial & Engineering Chemistry Research*, 34 (2), 591-598.
- Cullinane, J.T., Oyeneke, B.A., Lu, J, Rochelle, G. T. (2002). Carbon Dioxide Capture by Absorption with Potassium Carbonate, NETL funded project, University of Texas at Austin.
- Demirbas, A. (2005). Potential applications of renewable energy sources, biomass combustion problems in boiler power systems and combustion related environmental issues. *Progress in Energy and Combustion Science*, Volume 31, Issue 2, 2005, Pages 171-192.
- Demirbas, A. (2008). Carbon Dioxide Emissions and Carbonation Sensors Turkey, *Energy Sources*, Part A, 30:70-78.
- Dindore, V. Y., Brilman, D.W.F., Feron, G.F.H. and Versteeg, G.F. (2004). CO<sub>2</sub> absorption at elevated pressures using a hollow fiber membrane contactor, *Sep. Purif. Technol.* 40, 133-145
- DOW, (2005) Speciality Alkanolamines: Product information, The Dow Chemical Company (Herzog & Golomb, 2004).
- Department of Energy and Environmental Protection Agency, Washington DC, (2000).
- ESAA, (2003). *Electricity Australia 2003*, Electricity Supply Association of Australia, Sydney.
- Flagship Project: Wandoan Project, viewed at 18 July, 2010,  
[http://www.newgencoal.com.au/active-projects\\_flagship-projects.aspx?view=13](http://www.newgencoal.com.au/active-projects_flagship-projects.aspx?view=13)
- Fei, W. (2004). Plum Flower Mini Ring – A highly efficient packing for CO<sub>2</sub> capture and separation, In *Proceedings of the Separations Technology VI: New Perspectives on Very Large- Scale Operations*, Fraser Island.
- Fei, W. Y. and Song, X. Y. (2005) Comparison of packings for absorption with high liquid loading, *AIChE Spring National Meeting, Conference Proceedings; AIChE Spring National Meeting, Conference Proceedings*, 1817.
- Feron, P. H. M. (1992). CO<sub>2</sub> capture: The characterisation of gas separation/removal membrane systems applied to the treatment of flue gases arising from power generation using fossil fuel, Cheltenham, IEA/92/08, IEA Greenhouse Gas R & D Programme.
- Goldthorpe S. H., Cross, P. J. I., and Davison J. E. (1992). System Studies on CO<sub>2</sub> abatement from Power Plants; *Energy Conversion Management*. Volume 33, Issues 5-8, pp 459-466.
- GPSA, (2004). *Engineering Data Handbook*, Gas Processors Suppliers Association, Tulsa.  
<http://www.geos.ed.ac.uk/scs/capture/postcombustion.html>
- Ho, M.T. (2007). Techno-economic modeling of CO<sub>2</sub> captures systems for Australian industrial sources, PhD Thesis.

- Herzog, H., Golomb, D. and Zemba, S. (1991). Feasibility, modeling and economics of sequestering power plant CO<sub>2</sub> emissions in the deep ocean, *Environmental Progress*, 10(1), 64-74.
- Huijgen, W.J.J & Comans, R.N.J. (2003), Carbon dioxide sequestration by mineral carbonation, Literature Review, ECN-C--03-016.
- Huijgen, W. J. J. (2007). Carbon Dioxide Sequestration by Mineral Carbonation, PhD Thesis.
- IPCC, (2005). Carbon Dioxide Capture and Storage, Cambridge University Press, UK. pp 431.
- International energy agency, (2004). Prospects for CO<sub>2</sub> capture and storage, OECD/IEA.
- International Energy Agency - Greenhouse Gas R&D Programme (IEA-GHG), (2000). CO<sub>2</sub> storage as carbonate minerals, prepared by CSMA Consultants Ltd, PH3/17, Cheltenham, United Kingdom
- Johnson, D.C. (2000). A solution for carbon dioxide overload, *SCI Lect. Pap. Ser.* 108 (2000), pp. 1-10.).
- Kojima, T., Nagamine, A., Ueno, N. & Uemiya, S. (1997). Absorption and fixation of carbon dioxide by rock weathering, *Energy Conversion and Management*, 38, S461-466.
- Krevor, SC & Lackner, K.S. (2009). Enhancing process kinetics for mineral carbon sequestration, *Energy procedia*, vol.1, pp. 4867-4871.
- Kreutz, T.G., Williams, R.H., Socolow, R.H., Chiesa, P., and Lozza, G. (2002). Production of Hydrogen and Electricity from Coal with CO<sub>2</sub> Capture, Proceedings of the 6th International Conference on Greenhouse Gas Control Technologies (GHGT6), J. Gale and Y. Kaya (editors), Kyoto, Japan.
- Lackner, K.S., Wendt, C.H., Butt, D.P. Joyce, E.L. & Sharp, D.H. (1995). Carbon dioxide disposal in carbonate minerals, *Energy* 20(11), 1153-1170.
- Lackner, K.S., Butt, D.P. & Wendt, C.H.. (1997). Progress on binding CO<sub>2</sub> in mineral substrates, *Energy Conversion and Management*, 38, S259-264.
- Lu, J. G., Zheng, Y.F. and Cheng, M. D.(2009). Membrane contactor for CO<sub>2</sub> absorption applying amino-acid salt solutions, *Desalination* 249, 498-502.
- Lu, J. G., Wang, L. J., Sun, X..Y., Li, J. S., and Liu, X. D. (2005). Absorption of CO<sub>2</sub> into aqueous solutions of methyldiethanolamine and activated methyldiethanolamine from a gas mixture in a hollow fiber contactor, *Ind. Eng. Chem. Res.* 44, 9230-9238.
- Leci, C. L. (1996). Financial implications on power generation costs resulting from the parasitic effect of CO<sub>2</sub> capture using liquid scrubbing technology from power station flue gases, *Energy Conversion and Management*, 37 (6-8), 915-921.
- Mimura, T., Simayoshi, H., Suda, T., Iijima, M. and Mituoka, S. (1997) Development of energy saving technology for flue gas carbon dioxide recovery in power plant by chemical absorption method and steam system, *Energy Conversion and Management*, 38 (Supplement 1), S57-S62.
- MIT, (2007). The Future of Coal, p. 35.
- Marchetti, C. (1977). On geo engineering and the CO<sub>2</sub> problem, *Climatic Change*, 1, 59-68.
- Mineral carbonation project for NSW <http://www.sustainabilitymatters.net.au/articles/41409-Mineral-carbonation-project-for-NSW>
- National research flagships, CSIRO, 2009, Post-combustion capture at Munmorah <http://www.de.com.au/Sustainability/Greenhouse/Carbon-Capture-Research-Project/Carbon-Capture-Research-Project/default.aspx>, Viewed at 15July, 2010.

- Nikulshina, V., Galvez, E. and Steinfeld. (2007) A kinetic analysis of the carbonation reactions for the capture of CO<sub>2</sub> from air via the Ca(OH)<sub>2</sub>-CaCO<sub>3</sub>-CaO solar thermo chemical cycle, *Chem. Eng. J.* 129, pp. 75-83.
- Narula, R.G., Wen, H. and Himes, K. (2002). Incremental cost of CO<sub>2</sub> reduction in power plants, Proceedings of IGTI ASME TURBO EXPO.
- O'Connor, W.K., Dahlin, D.C., Nilsen, D.N., Rush, G.E., Walters, P. R. and Turner, P.C. (2001). Carbon Dioxide Sequestration by Direct Mineral Carbonation: Results from Recent Studies and Current Status, presented at the First National Conference on Carbon Sequestration, Washington, DC.
- O'Connor, W.K., Dahlin, D.C., Nilsen, D.N., Walters, R.P. & Turner, P.C. (2000) Carbon dioxide sequestration by direct mineral carbonation with carbonic acid, 25th International Technical Conference on Coal Utilization and Fuel Systems, Clearwater, FL, USA.
- O'Connor, W.K., Dahlin, D.C., Rush, G.E., Gerdemann, S.J., Penner, L.R. & Nilsen, D.N. (2005) Aqueous mineral carbonation: mineral availability, pretreatment, reaction parameters and process studies, DOE/ARC-TR-04-002, Albany Research Center, Albany, OR, USA.
- Plasynski, S.I. and Chen, Z.Y. (2000). Review of carbon capture technology and some improvement opportunities, American Chemical Society, 220 (2000) U391-U391.
- Park, A.-H.A., Jadhav, R. & Fan, L.-S. (2003) CO<sub>2</sub> mineral sequestration: chemically enhanced aqueous carbonation of serpentine, *Canadian Journal of Chemical Engineering* 81(3), 885-890.
- Parker, L., Folger, P. and Stine, D.D. (2008) Capturing CO<sub>2</sub> from Coal-Fired Power Plants: Challenges for a Comprehensive Strategy, CRS report for congress.
- Prigobbe, V., Poletini, A. and Baciocchi, R.. (2009), Gas-solid carbonation kinetics of Air Pollution Control residues for CO<sub>2</sub> storage, *Chemical Engineering Journal*, Volume 148, Issues 2-3, Pages 270-278.
- Powerspan Corp. (2008). Carbon Capture Technology for Existing and New Coal-Fired Power Plants.
- Ryan M. D. and Donald S. S. (2008), An Introduction to CO<sub>2</sub> Capture and Sequestration Technology, *Utility Engineering*, p. 7.
- Sipila, J, Teir, S and Zevenhoven, R..(2007). Carbon dioxide sequestration by mineral carbonation Literature review update, 2005-2007, report VT 2008-1.
- Seifritz, W. (1990), CO<sub>2</sub> disposal by means of silicate, *Nature*, vol. 345, pp. 48.
- Skarstrom, C. W. (1960). Method and apparatus for fractionating gaseous mixtures by adsorption, Patent. No. 2944627, US.
- Scottish carbon capture and storage, viewed at 18 July, 2010  
<http://www.geos.ed.ac.uk/scs/capture/precombustion.html>
- Scottish carbon capture and storage, viewed at 18 July, 2010  
<http://www.geos.ed.ac.uk/scs/capture/oxyfuel.html>
- Scottish carbon capture and storage, viewed at 18 July, 2010  
<http://www.geos.ed.ac.uk/scs/capture/postcombustion.html>
- World coal institute, <http://www.worldcoal.org/coal/uses-of-coal/coal-electricity>, viewed at 20 July, 2010.

- Williams, M., (2002). Climate change: information kit, Geneva: the United Nations Environment Programme (UNEP) and the United Nations Framework Convention on Climate Change (UNFCCC).
- Williams, R.H. (2003). Decarburization of Fossil Fuels for the Production of Fuels and Electricity, presented at the Canadian Clean Coal Technology Roadmap Workshop, Calgary, Alberta.
- Zevenhoven, R. & Kohlmann, J. (2002). CO<sub>2</sub> sequestration by magnesium silicate mineral carbonation in Finland, *Recovery, Recycling & Re-integration*, Geneva, Switzerland.
- Zero Gen Project, <http://www.zerogen.com.au/factsheets.aspx>, viewed at 18 July, 2010.

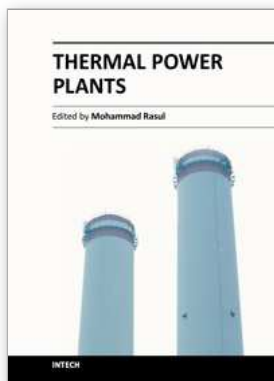

## **Thermal Power Plants**

Edited by Dr. Mohammad Rasul

ISBN 978-953-307-952-3

Hard cover, 266 pages

**Publisher** InTech

**Published online** 13, January, 2012

**Published in print edition** January, 2012

Thermal power plants are one of the most important process industries for engineering professionals. Over the past few decades, the power sector has been facing a number of critical issues. However, the most fundamental challenge is meeting the growing power demand in sustainable and efficient ways. Practicing power plant engineers not only look after operation and maintenance of the plant, but also look after a range of activities, including research and development, starting from power generation, to environmental assessment of power plants. The book *Thermal Power Plants* covers features, operational issues, advantages, and limitations of power plants, as well as benefits of renewable power generation. It also introduces thermal performance analysis, fuel combustion issues, performance monitoring and modelling, plants health monitoring, including component fault diagnosis and prognosis, functional analysis, economics of plant operation and maintenance, and environmental aspects. This book addresses several issues related to both coal fired and gas turbine power plants. The book is suitable for both undergraduate and research for higher degree students, and of course, for practicing power plant engineers.

### **How to reference**

In order to correctly reference this scholarly work, feel free to copy and paste the following:

S. Moazzem, M.G. Rasul and M.M.K. Khan (2012). A Review on Technologies for Reducing CO<sub>2</sub> Emission from Coal Fired Power Plants, *Thermal Power Plants*, Dr. Mohammad Rasul (Ed.), ISBN: 978-953-307-952-3, InTech, Available from: <http://www.intechopen.com/books/thermal-power-plants/a-review-on-technologies-for-reducing-co2-emission-from-coal-fired-power-plants>

**INTECH**  
open science | open minds

### **InTech Europe**

University Campus STeP Ri  
Slavka Krautzeka 83/A  
51000 Rijeka, Croatia  
Phone: +385 (51) 770 447  
Fax: +385 (51) 686 166  
[www.intechopen.com](http://www.intechopen.com)

### **InTech China**

Unit 405, Office Block, Hotel Equatorial Shanghai  
No.65, Yan An Road (West), Shanghai, 200040, China  
中国上海市延安西路65号上海国际贵都大饭店办公楼405单元  
Phone: +86-21-62489820  
Fax: +86-21-62489821

© 2012 The Author(s). Licensee IntechOpen. This is an open access article distributed under the terms of the [Creative Commons Attribution 3.0 License](#), which permits unrestricted use, distribution, and reproduction in any medium, provided the original work is properly cited.