

Robust Adaptive Position/Force Control of Mobile Manipulators

Tatsuo Narikiyo and Michihiro Kawanishi
*Toyota Technological Institute
Japan*

1. Introduction

A mobile manipulator is a class of mobile robot on which the multi-link manipulator is mounted. This system is expected to play an important role both in the production process of factory and in the medical care system of welfare business. To come up to this expectation, a mobile manipulator is required to simultaneously track to both the desired position trajectory and force trajectory. However, these tracking performances are subject to nonholonomic and holonomic constraints. Furthermore, mobile manipulators possess complex and strongly coupled dynamics of mobile bases and manipulators. Then, there are very few studies on the problems of stabilization position/force control for mobile manipulators.

In (Chang & Chen, 2002; Oya et al., 2003; Su et al., 1999), position and force control methods for mobile robot without manipulators have been addressed. Since in these studies holonomic constraints representing the interaction between end-effector of the manipulator and environment have not been considered, those approaches could not be applied to the position/force control problems of the mobile manipulators. In (Dong, 2002; Li et al., 2007; 2008), adaptive and robust control approaches have been applied to the position/force control problems of the mobile manipulators. In these approaches, since the chained form transforms are required, synthesis methods of the control torques and adaptation laws of these approaches are too complicated to apply. On the other hand, we have derived the stabilizing controllers for a class of mobile manipulators (Narikiyo et al., 2008). In (Narikiyo et al., 2008) we have proposed robust adaptive control scheme for the system with dynamic uncertainties and external disturbances directly from the reduced order dynamics subject to both the holonomic and nonholonomic constraints. Furthermore, in (Narikiyo et al., 2009) we have developed this control scheme to control the system with both kinematic and dynamic uncertainties. In these studies usefulness of these control schemes have been demonstrated by numerical examples. However, proof of the closed loop stability has not been completed under an inadequate assumption (Narikiyo et al., 2009).

In this study we complete the proof and relax the assumptions of (Narikiyo et al., 2009). Then we implement these control schemes (Narikiyo et al., 2008; 2009) experimentally and apply to the prototype shown in Fig.1 to demonstrate the effectiveness of these proposed control schemes. It is also guaranteed theoretically that the tracking position and force errors to the desired trajectories are asymptotically converged to zero by the proposed control schemes.

2. Modeling of mobile manipulator



Fig. 1. Mobile manipulator

Fig.1 shows the prototype of mobile manipulator employed in experiments. Let $q_B \in R^n$, $q_M \in R^m$ and $q = [q_B^T \ q_M^T]^T \in R^{n+m}$ be the generalized coordinates of the mobile base, manipulator and whole system, respectively. Then the equations of nonholonomic constraints imposed on the mobile base are written as

$$J_B(q_B)\dot{q}_B = 0, \tag{1}$$

where $q_B = [q_{B1}^T \ q_{B2}^T]^T$ and $J_B(q_B) = [J_{B1} \ J_{B2}] \in R^{(n-k) \times n}$, $\det J_{B1} \neq 0$. The equations of holonomic constraints imposed on the manipulator are given by

$$\Phi(q) = 0, \tag{2}$$

where $\Phi(q) \in R^{m-h}$. Let $J_M(q) = \partial\Phi/\partial q \in R^{(m-h) \times (n+m)}$, $\text{rank} J_M = m - h$. Then (2) can be rewritten as

$$J_M(q)\dot{q} = 0. \tag{3}$$

Furthermore, let

$$J_M(q) = \left[\frac{\partial\Phi}{\partial q_B} \quad \frac{\partial\Phi}{\partial q_{M1}} \quad \frac{\partial\Phi}{\partial q_{M2}} \right] = [J_{M0} \ J_{M1} \ J_{M2}],$$

$q_M = [q_{M1}^T \ q_{M2}^T]^T$, $q_{M1} \in R^h$, $q_{M2} \in R^{m-h}$ and $\det J_{M2} \neq 0$. Then the equations of motion of the mobile manipulator is written as

$$M(q)\ddot{q} + C(q, \dot{q})\dot{q} + G(q) + d(q, t) = J^T(q)\lambda + B(q)\tau, \tag{4}$$

$$J(q)\dot{q} = 0, \tag{5}$$

where

$$M(q) = \begin{bmatrix} M_{11}(q) & M_{12}(q) \\ M_{21}(q) & M_{22}(q) \end{bmatrix}, G(q) = \begin{bmatrix} G_{11}(q) \\ G_{21}(q) \end{bmatrix}, C(q, \dot{q}) = \begin{bmatrix} C_{11}(q, \dot{q}) \\ C_{21}(q, \dot{q}) \end{bmatrix},$$

$$B(q) = \begin{bmatrix} B_{11}(q_B) & 0 \\ 0 & I_m \end{bmatrix}, d(q, t) = \begin{bmatrix} d_{11}(q, t) \\ d_{21}(q, t) \end{bmatrix},$$

$$J(q) = \begin{bmatrix} J_B & 0 & 0 \\ J_{M0} & J_{M1} & J_{M2} \end{bmatrix}, \tau = \begin{bmatrix} \tau_B \\ \tau_M \end{bmatrix}, \lambda = \begin{bmatrix} \lambda_B \\ \lambda_M \end{bmatrix}.$$

Indices $\{i, j = 1, 2\}$ correspond to decompositions of q_B, q_M . $d(t)$ denotes uncertain disturbance. For $\lambda = [\lambda_B^T \ \lambda_M^T]^T$, $\lambda_B \in R^{n-k}$ denote reaction forces acted on the wheels from the floor and $\lambda_M \in R^{m-h}$ denote reaction forces acted on the end-effector from the environment. The equation (4) has following properties(Slotine & Li, 1991).

Property 1: $\dot{M} - 2C$ is skew symmetric.

Property 2: For any ξ

$$M(q)\ddot{\xi} + C(q, \dot{q})\dot{\xi} + G(q) = Y(q, \dot{q}, \xi, \dot{\xi})p_0,$$

where $p_0 \in R^{s_0}$ denotes unknown parameter vector and $Y \in R^{(n+m) \times s_0}$ is called regressor matrix whose elements consist of known functions.

Let $f_B(q_B) = [f_1(q_B), \dots, f_k(q_B)]$ be the bases of null space of $J_B(q_B)$, then there exists $\eta = [\eta_1, \dots, \eta_k]^T$ such that (1) is equivalent to

$$\dot{q}_B = f_B(q_B)\eta. \tag{6}$$

Using the suitable selection of $f_B(q_B)$, η can be specified to be equal to forward linear velocity u and angular velocity ω of the mobile base, that is, $k = 2$ and $\eta = [\eta_1 \ \eta_2]^T = [u \ \omega]^T$, without loss of generality. Since η corresponds to angular velocity of wheels v_B , there exists φ such that $v_B = \varphi\eta$. Therefore (6) is rewritten as

$$\dot{q}_B = S_B(q_B)v_B, \tag{7}$$

where

$$S_B(q_B) = f_B(q_B)\varphi^{-1} = \begin{bmatrix} -J_{B1}^{-1}J_{B2} \\ I_k \end{bmatrix}.$$

Furthermore, let

$$S(q_B) = \text{Blockdiag} \{S_B(q_B), I_m\} \in R^{(n+m) \times (k+m)},$$

$$v = \left[v_B^T, \dot{q}_{M1}^T, - \left\{ J_{M2}^{-1} \left(J_{M0}f_B\varphi^{-1}v_B + J_{M1}\dot{q}_{M1} \right) \right\}^T \right]^T \in R^{k+m},$$

then we have

$$\dot{q} = S(q_B)v. \tag{8}$$

Differentiating (8), substituting it into (4) and multiplying both sides by $S^T(q_B)$ from the left, we have(Yamamoto & Yun, 1996)

$$M_1(q)\dot{v} + C_1(q, \dot{q})v + G_1(q) + d_1(q, t) = B_1(q)\tau + \bar{J}_M^T(q)\lambda_M, \tag{9}$$

where

$$M_1(q) = S^T(q_B)M(q)S(q_B),$$

$$C_1(q, \dot{q}) = S^T(q_B) \{M(q)\dot{S}(q_B) + C(q, \dot{q})S(q_B)\},$$

$$G_1(q) = S^T(q_B)G(q), d_1(q, t) = S^T(q_B)d(q, t),$$

$$B_1(q) = S^T(q_B)B(q), \bar{J}_M = \left[J_{M0}f_B\varphi^{-1} \ J_{M1} \ J_{M2} \right].$$

It is well known that Property 1 and 2 are invariant under changes of coordinates(Murray et al., 1993). Then (9) has following properties similarly to (4).

Property 3: $\dot{M}_1 - 2C_1$ is skew-symmetric.

Property 4: For any $\bar{\xi}$

$$M_1(q)\ddot{\bar{\xi}} + C_1(q, \dot{q})\dot{\bar{\xi}} + G_1(q) = Y_1(q, \dot{q}, \bar{\xi}, \dot{\bar{\xi}})p_1,$$

where $p_1 \in R^{s_1}$ denotes unknown parameter vector and $Y_1 \in R^{(k+m) \times s_1}$ is called the regressor matrix whose elements consist of known functions. Furthermore, kinematic uncertainties of the system give the following properties (Cheah et al., 2003; Fukao et al., 2000).

Property 5: $S_B(q_B)v_B$ in (7) can be written as

$$S_B(q_B)v_B = \sum_{i=1}^k \left(\sigma_{i0}(q_B) + \sum_{j=1}^{h_i} \theta_{ij} \sigma_{ij}(q_B) \right) v_{Bi}.$$

Property 6: $\bar{J}_M^T(q)\lambda_M$ in (9) can be written as

$$\bar{J}_M^T(q)\lambda_M = Z_1(q, \lambda_M)\psi,$$

where θ_{ij} is unknown parameter which consists of unknown parameters of mobile base, and σ_{ij} is known functions which consists of the coordinate q_B , ($i = 1, \dots, k, j = 1, \dots, h_i$). $\psi \in R^c$ is unknown parameter vector of the whole system and $Z_1(q, \lambda_M) \in R^{(k+m) \times c}$ is known matrix function of the position/force coordinate q and λ_M , respectively.

Following assumptions are required to synthesize the control scheme.

Assump.1: There are no unknown parameters in $B_1(q)$ and $\det B_1(q) \neq 0$ for all q . d_1 and its derivative are bounded and $\|d_1\| \leq D$. Where D is unknown.

Assump.2: $J_B, J_M, J_{B1}^{-1}, J_{M2}^{-1} \in L_\infty$ and these matrices are all continuously differentiable with respect to q and kinematic parameters, and these derivatives are bounded.

3. Hybrid position/force control scheme

Let q^* be the desired position trajectory, then there exist desired velocity input $v^* = [v_1^*, \dots, v_k^*, v_M^{*T}]^T$ such that

$$\dot{q}^* = S(q_B^*)v^*. \tag{10}$$

Since $[v_1^*, \dots, v_k^*]^T$ are desired velocities of the mobile base, we can set $[v_1^* \ v_2^*]^T = \varphi[u^* \ \omega^*]^T$ and $k = 2$ without loss of generality. Where desired forward linear velocity u^* and desired angular velocity ω^* of the mobile base. Using the relations such as $v_{M1}^* = \dot{q}_{M1}^*$ and $v_{M2}^* = \dot{q}_{M2}^*$, $v_{M2}^*(= \dot{q}_{M2}^*)$ can be determined by v_{M1}^* and u^*, ω^* . For these values following assumptions are required.

Assump.3: $q^*, u^*, \omega^*, \dot{q}^*, \dot{u}^*, \dot{\omega}^*, \ddot{q}^*, \ddot{u}^*, \ddot{\omega}^*$ and \ddot{q}^* are bounded globally. And $u^* \neq 0$.

3.1 Reference robot

To specify error dynamics of trajectory tracking system we introduce the reference robot shown in Fig.1. Trajectory error e_B for base coordinates $q_B = [x \ y \ \phi]^T$, trajectory error e_{M1} for manipulator coordinates q_{M1} and trajectory error $\tilde{\lambda}_M$ for constrained forces are given

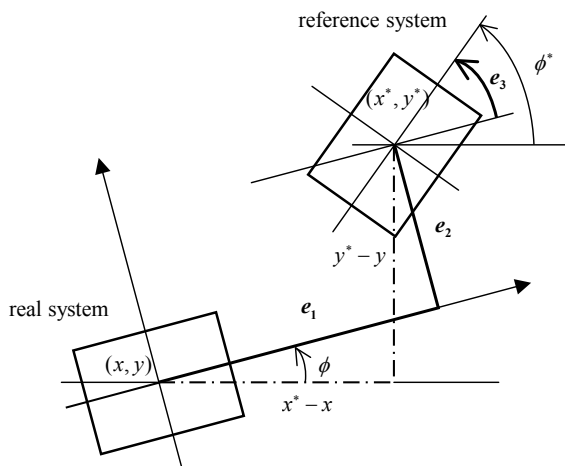

Fig. 2. Reference robot and tracking errors by

$$e_B = \begin{bmatrix} e_1 \\ e_2 \\ e_3 \end{bmatrix} = \begin{bmatrix} (x^* - x) \cos \phi + (y^* - y) \sin \phi \\ -(x^* - x) \sin \phi + (y^* - y) \cos \phi \\ \phi^* - \phi \end{bmatrix}$$

$$e_{M1} = q_{M1}^* - q_{M1}, \quad \tilde{\lambda}_M = \lambda_M - \lambda_M^* \tag{11}$$

Using the results in (Fukao et al., 2000), desired velocity inputs $v_c = [v_{Bc}^T \ v_{M1c}^T \ v_{M2c}^T]^T$ for trajectory tracking are written as the following.

$$v_{Bc} = \varphi u_{Bc}, \quad u_{Bc} = \begin{bmatrix} u_c \\ \omega_c \end{bmatrix}$$

$$= \begin{bmatrix} u^* \cos e_3 + K_1 e_1 \\ \omega^* + u^* K_2 e_2 + K_3 \sin e_3 \end{bmatrix}$$

$$v_{M1c} = \dot{q}_{M1}^* + K_{M1} e_{M1}$$

$$v_{M2c} = -J_{M2}^{-1} (J_{M0} f_B \varphi^{-1} v_{Bc} + J_{M1} v_{M1c}) \tag{12}$$

Where $K_i > 0, i = 1, 2, 3$ and K_{M1} are arbitrarily assigned. For the system (7) the following Lemma is shown in (Fukao et al., 2000).

Lemma 1. *If $v_B = v_{Bc}$ is applied to (7), then the first derivatives of trajectory error coordinates are given by the following equations.*

$$\begin{aligned} \dot{e}_1 &= -K_1 e_1 + (\omega^* + u^* K_2 e_2 + K_3 \sin e_3) e_2 \\ \dot{e}_2 &= -(\omega^* + u^* K_2 e_2 + K_3 \sin e_3) e_1 + u^* \sin e_3 \\ \dot{e}_3 &= -u^* K_2 e_2 - K_3 \sin e_3 \end{aligned} \tag{13}$$

Then, $\lim_{t \rightarrow \infty} e_B = 0$.

However, since Lemma1 has not considered kinematic parameter uncertainties, v_{Bc} cannot be applied to our problem. Therefore, we give the following assumption similar manner to (Fukao et al., 2000).

Assump.4: There exist velocity inputs and adaptive laws:

$$\begin{aligned} v_B &= v_{Bc}(q_B, q_B^*, \hat{a}) \\ \dot{\hat{a}}_i &= T_i(q_B, q_B^*, \hat{a}) \end{aligned} \tag{14}$$

such that the closed loop system of (7) is stable at q_B^* . Furthermore, there exists Lyapunov function $V_1(q_B, q_B^*, \tilde{a})$ such that the time derivative of V_1 along the closed loop system of (7) with (14) is negative semi-definite. Where \hat{a} is the estimate of an unknown parameter vector $a = [a_1, \dots, a_k]^T$, which is composed of θ_{ij} , and $\tilde{a} = \hat{a} - a$ is the estimated error.

3.2 Control laws for the system with both kinematic and dynamic uncertainties

In this section we propose the robust and adaptive position/force control scheme of the mobile manipulators with both the kinematic and dynamic uncertainties. To begin with, we introduce filter coordinates in a similar way to (Yuan, 1997) as follows. For any constant α_1 we set $\beta_M \in R^m$ as

$$\dot{\beta}_M = -\alpha_1 \beta_M - \alpha_1 \left[\hat{J}_{M1} \hat{J}_{M2} \right]^T \tilde{\lambda}_M, \tag{15}$$

where $\hat{J}_M(q, \hat{\psi})$ denotes the Jacobian matrix which is replaced ψ with estimate $\hat{\psi}$ and

$$\begin{aligned} \hat{J}_M(q, \hat{\psi}) &= \left[\hat{J}_{M0}(q, \hat{\psi}) f_B(q_B) \hat{\phi}^{-1} \hat{J}_{M1}(q, \hat{\psi}) \hat{J}_{M2}(q, \hat{\psi}) \right] \\ &= \left[\hat{J}_{M0}(q, \hat{\psi}) \hat{J}_{M1}(q, \hat{\psi}) \hat{J}_{M2}(q, \hat{\psi}) \right]. \end{aligned}$$

Secondly, we set

$$\begin{aligned} \tilde{v} &= v - v_c, \beta = [0_k^T \ \beta_M^T]^T, \tilde{v} = R\tilde{s}, \delta = \tilde{v} + \beta, \\ \chi &= v_c - \beta, \tilde{s} = [\tilde{v}_B^T \ \tilde{v}_{M1}^T]^T, e = [e_B^T \ e_M^T]^T, \end{aligned} \tag{16}$$

where

$$R = \begin{bmatrix} I_k & 0 \\ 0 & I_l \\ -\hat{J}_{M2}^{-1} \hat{J}_{M0} & -\hat{J}_{M2}^{-1} \hat{J}_{M1} \end{bmatrix}.$$

Finally we introduce variable $\rho(t)$ which satisfies following conditions (Li et al., 2008).

- (1) $\rho(t) > 0, \forall t \in [0, \infty)$
- (2) $\lim_{t \rightarrow \infty} \rho(t) = 0$
- (3) $\lim_{t \rightarrow \infty} \int_0^t \rho(\tau) d\tau = \rho_0 < \infty$

Under assumptions from Assump.1 to Assump.4, following theorem is derived.

Theorem 1. Applying the following control law and adaptive laws to the mobile manipulator (4) and (5),

$$\begin{aligned} \tau &= B_1^{-1} \left[-K_d \delta - F + Y_1(q, \dot{q}, \chi, \dot{\chi}) \hat{p}_1 - \left(\frac{\partial V_1}{\partial q} \hat{S}(q_B, \hat{\theta}) \right)^T \right. \\ &\quad \left. + \alpha_2 \hat{J}_M^T(q, \hat{\psi} \tilde{\lambda}_M) - Z_1(q, \lambda_M) \hat{\psi} \right] \\ \dot{\hat{p}}_1 &= -\Gamma_1 Y_1^T(q, \dot{q}, \chi, \dot{\chi}) \delta \\ \dot{\hat{\psi}} &= \Gamma_2 Z_1^T(q, \lambda_M) \delta \\ \dot{\hat{a}}_i &= T_i(q_B, q_B^*, \hat{a}) \\ \dot{\hat{\theta}}_i &= \Lambda_i \left(\frac{\partial V_1}{\partial q} \sigma_i \right)^T \tilde{v}_i \\ \dot{D} &= \gamma \|\delta\| \end{aligned} \tag{17}$$

then all internal signals are bounded and

$$\lim_{t \rightarrow \infty} e = 0, \lim_{t \rightarrow \infty} \tilde{\lambda}_M = 0, \tag{18}$$

where $\hat{\theta}_i$ is estimate of θ_i , $\sigma_i = [\sigma_{i1}, \dots, \sigma_{ih_i}]$, $1 \leq i \leq k$, and $K_d, \Gamma_1, \Gamma_2, \Lambda_i$ are positive definite matrix with appropriate dimensions, α_2 is arbitrary constant and

$$F(t) = \frac{\delta \dot{D}^2}{\|\delta\| \dot{D} + \rho(t)}.$$

Letting parameter estimation errors be $\tilde{p} = \hat{p} - p$ and $\tilde{D} = \hat{D} - D$, closed loop system can be written as follows.

$$\begin{aligned} M_1 \dot{\delta} &= -(C_1 + K_d) \delta + Y_1(q, \dot{q}, \chi, \dot{\chi}) \tilde{p}_1 - \left(\frac{\partial V_1}{\partial q} \hat{S}(q_B, \hat{\theta}) \right)^T \\ &\quad + \alpha_2 \hat{J}_M^T \tilde{\lambda}_M - Z_1 \tilde{\psi} - (F + d_1) \end{aligned} \tag{19}$$

Proof of this theorem is shown by the following Lemmas.

Lemma 2. For the closed loop system, $\delta, \beta \in L_2$, and $\tilde{v}, \hat{p}, e_{M1}, \dot{e}_{M1}, v_c, \chi, q, \dot{q}, \hat{\theta}, \hat{\psi}, \hat{a}, \dot{D} \in L_\infty$.

(Proof)

We set V_2 as

$$\begin{aligned} V_2 &= V_1 + \frac{1}{2} \delta^T M_1 \delta + \frac{1}{2} \alpha_2 \alpha_1^{-1} \beta^T \beta + \frac{1}{2} \tilde{p}_1^T \Gamma^{-1} \tilde{p}_1 \\ &\quad + \frac{1}{2} \sum_{i=1}^k \tilde{\theta}_i^T \Lambda_i^{-1} \tilde{\theta}_i + \frac{1}{2} \tilde{\psi}^T \Gamma_2^{-1} \tilde{\psi} + \frac{1}{2\gamma} \tilde{D}^2. \end{aligned} \tag{20}$$

Differentiating V_2 along (19), we have

$$\begin{aligned} \dot{V}_2 &= \frac{\partial V_1}{\partial q} S(q_B)(v_c + \tilde{v}) + \frac{\partial V_1}{\partial q^*} S(q_B^*) v^* + \sum_{i=1}^g \frac{\partial V_1}{\partial \hat{a}_i} T_i - \delta^T K_d \delta \\ &\quad - \frac{\partial V_1}{\partial q} \hat{S}(q_B) \tilde{v} - \alpha_2 \beta^T \beta + \sum_{i=1}^k \tilde{\theta}_i^T \Lambda_i^{-1} \dot{\tilde{\theta}}_i - \delta^T (F + d_1) + \frac{\tilde{D} \dot{\tilde{D}}}{\gamma}. \end{aligned}$$

In this computation, we used the relations $\frac{\partial V_1}{\partial q} \hat{S} \beta = 0$ and:

$$\begin{aligned} \hat{J}_M R &= \begin{bmatrix} \hat{J}_{M0} & \hat{J}_{M1} & \hat{J}_{M2} \end{bmatrix} \begin{bmatrix} I_k & 0 \\ 0 & I_l \\ -\hat{J}_{M2}^{-1} \hat{J}_{M0} & -\hat{J}_{M2}^{-1} \hat{J}_{M1} \end{bmatrix} \\ &= \begin{bmatrix} 0_{(m-l) \times k} & 0_{(m-l) \times l} \end{bmatrix}. \end{aligned}$$

Furthermore, by using the relation

$$\begin{aligned} \frac{\partial V_1}{\partial q} \hat{S}(q_B) \tilde{v} &= \frac{\partial V_1}{\partial q} (\hat{S} - S) \tilde{v} = \frac{\partial V_1}{\partial q} \left[\sum_{i=1}^k \left(\sigma_{i0}(q_B) + \sum_{j=1}^{l_i} \hat{\theta}_{ij} \sigma_{ij}(q_B) \right) \right. \\ &\quad \left. - \sum_{i=1}^k \left(\sigma_{i0}(q_B) + \sum_{j=1}^{l_i} \theta_{ij} \sigma_{ij}(q_B) \right) \right] v_{Bi} = \frac{\partial V_1}{\partial q} \sum_{i=1}^k \sigma_i \tilde{\theta}_i \tilde{v}_i \end{aligned}$$

we have

$$\dot{V}_2 = \dot{V}_1^{v_B=v_{BC}} - \delta^T K_d \delta - \alpha_2 \beta^T \beta - \delta^T (F + d_1) + \frac{\tilde{D} \dot{D}}{\gamma}, \tag{21}$$

where

$$\dot{V}_1^{v_B=v_{BC}} = \frac{\partial V_1}{\partial q} S(q_B) v_c + \frac{\partial V_1}{\partial q^*} S(q_B^*) v^* + \sum_{i=1}^g \frac{\partial V_1}{\partial \hat{a}_i} T_i \leq 0.$$

Last inequality sign \leq is given by Assump.4. From the definition of $F(t)$ and adaptive law of \hat{D} following inequality is derived.

$$\begin{aligned} -\delta^T (F + d_1) + \frac{\tilde{D} \dot{D}}{\gamma} &= -\delta^T \frac{\delta \hat{D}^2}{\|\delta\| \hat{D} + \rho(t)} - \delta^T d_1 + \frac{\tilde{D} \dot{D}}{\gamma} - \frac{D \dot{D}}{\gamma} \\ &< -\frac{\|\delta\|^2 \hat{D}^2}{\|\delta\| \hat{D} + \rho(t)} + \|\delta\| D + \frac{\tilde{D} \dot{D}}{\gamma} - \frac{D \dot{D}}{\gamma} \\ &= -\frac{\|\delta\|^2 \hat{D}^2}{\|\delta\| \hat{D} + \rho(t)} + \frac{\hat{D}(\gamma \|\delta\|)}{\gamma} + \frac{D}{\gamma} (\gamma \|\delta\| - \dot{D}) \\ &= \frac{\rho(t) \|\delta\| \hat{D}}{\|\delta\| \hat{D} + \rho(t)} < \rho(t) \end{aligned}$$

These inequalities lead the right hand of (32) to

$$\dot{V}_2 < -\delta^T K_d \delta - \alpha_2 \beta^T \beta + \rho(t). \tag{22}$$

Integrating both sides of this inequality and using definition of $\rho(t)$, we have

$$V_2(t) - V_2(0) < -\int_0^t \delta^T K_d \delta d\tau - \alpha_2 \int_0^t \beta^T \beta d\tau + \rho_0 < \infty. \tag{23}$$

This shows

$$V_2(t) < V_2(0) + \rho_0 < \infty. \tag{24}$$

Therefore, $V_2(t)$ is bounded, that is, $q_B, \tilde{a}, \delta, \beta, \tilde{p}_1, \tilde{D}, \tilde{\theta}, \tilde{\psi} \in L_\infty$, and $\delta, \beta \in L_2$. From definition of variable \tilde{v} , we have $\tilde{v} \in L_\infty$. Since unknown parameters are constant and bounded, $\hat{p}, \hat{D}, \hat{a}, \hat{\theta}, \hat{\psi} \in L_\infty$. From (12) and definitions of ν and ν_c , $\tilde{v}_{M1} = -\dot{e}_{M1} - K_{M1}e_{M1} \in L_\infty$. Then $e_{M1}, \dot{e}_{M1} \in L_\infty$. From (12), Assump.3 and Assump.4, we have $\nu_c, \chi \in L_\infty$. From Assump.2 and Assump.3, we have $q_M, \dot{q}_M \in L_\infty$. Similarly from $\tilde{v}, \nu_c \in L_\infty$ and Assump.2, we have $\dot{q}_B, \dot{e}_B \in L_\infty$. Therefore $q, \dot{q} \in L_\infty$.

Lemma 3. Let $\hat{M}_1 = M_1(\hat{p}_1)$ and

$$\Delta(\psi, \hat{\psi}) = \bar{J}_M^T \left(\hat{J}_M \hat{J}_M^T \right)^{-1} \hat{J}_M + \left(\hat{J}_M^T \right)^\dagger - I_{k+m},$$

where $\left(\hat{J}_M^T \right)^\dagger$ is left annihilator of \hat{J}_M^T . If there exist α_1 and α_2 such that

$$\{ \alpha_1 \hat{M}_1 \text{Blockdiag}(0_k, I_m) + \alpha_2 I_{k+m} + \Delta(\psi, \hat{\psi}) \}$$

is nonsingular, then $\tilde{\lambda}_M \in L_\infty$.

(Proof)

Substituting (15) and (16) into (19), we have

$$\begin{aligned} & \{ \alpha_1 \hat{M}_1 \text{Blockdiag}(0_k, I_m) + \alpha_2 I_{k+m} + \Delta(\psi, \hat{\psi}) \} \hat{J}_M^T \tilde{\lambda}_M \\ &= M_1(R\tilde{s} + \hat{R}\tilde{s}) + (C_1 + K_d)\delta - Y_1(q, \dot{q}, \chi, \dot{\chi} + \dot{\beta})\tilde{p}_1 - \alpha_1 \hat{M}_1\beta \\ &+ \left(\frac{\partial V_1}{\partial q} \hat{S}(q_B, \hat{\theta}) \right)^T + \Delta(\psi, \hat{\psi}) \hat{J}_M^T \lambda_M^* + (F + d_1). \end{aligned} \tag{25}$$

In this calculation, following relations are used.

$$\begin{aligned} Y_1(q, \dot{q}, \chi, \dot{\chi})\tilde{p}_1 &= Y_1(q, \dot{q}, \chi, \dot{\chi} + \dot{\beta})\tilde{p}_1 - \{ \hat{M}_1(q) - M_1(q) \} \dot{\beta} \\ Z_1\tilde{\psi} &= \left(\hat{J}_M^T - \bar{J}_M^T \right) \tilde{\lambda}_M + \left(\hat{J}_M^T - \bar{J}_M^T \right) \lambda_M^* \\ &= -\Delta(\psi, \hat{\psi}) \hat{J}_M^T \tilde{\lambda}_M - \Delta(\psi, \hat{\psi}) \hat{J}_M^T \lambda_M^* \end{aligned}$$

Multiplying (25) by $\hat{J}_M M_1^{-1}$ from left, we have

$$\begin{aligned} & \hat{J}_M M_1^{-1} \{ \alpha_1 \hat{M}_1 \text{Blockdiag}(0_k, I_m) + \alpha_2 I_{k+m} + \Delta(\psi, \hat{\psi}) \} \\ & \times \hat{J}_M^T \tilde{\lambda}_M = \hat{J}_M \left[\hat{R}\tilde{s} + M_1^{-1} \{ (C_1 + K_d)\delta \right. \\ & \left. - Y_1(q, \dot{q}, \chi, \dot{\chi} + \dot{\beta})\tilde{p}_1 + \alpha_1 \hat{M}_1\beta \right. \\ & \left. + \left(\frac{\partial V_1}{\partial q} \hat{S}(q_B, \hat{\theta}) \right)^T + \Delta(\psi, \hat{\psi}) \hat{J}_M^T \lambda_M^* + (F + d_1) \right]. \end{aligned} \tag{26}$$

By definition and Assump.3 $\dot{v}_c \in L_\infty$ and $\dot{\chi} + \dot{\beta} = \dot{v}_c$, we have

$$Y_1(q, \dot{q}, \chi, \dot{\chi} + \dot{\beta}) \in L_\infty.$$

Therefore, if α_1 and α_2 are selected such that

$$\{\alpha_1 \hat{M}_1 \text{Blockdiag}(0_k, I_m) + \alpha_2 I_{k+m} + \Delta(\psi, \hat{\psi})\}$$

is nonsingular, then $\tilde{\lambda}_M \in L_\infty$.

Lemma 4. $Z_1, \dot{v}_c, \dot{\beta}, \dot{\chi}, Y_1(q, \dot{q}, \chi, \dot{\chi}), F(t) \in L_\infty$.

(Proof)

$Z_1 \in L_\infty$ is derived from Lemma 2 and 3. $\dot{v}_c \in L_\infty$ is derived from definition of v_c , Assump.2 and adaptive laws of $\hat{a}, \hat{\psi}$. $\dot{\beta} \in L_\infty$ is derived directly from (15). Then $\dot{\chi} = \dot{v}_c - \dot{\beta} \in L_\infty$. These relations imply $Y_1(q, \dot{q}, \chi, \dot{\chi}) \in L_\infty$. And finally,

$$\|F(t)\| = \left\| \frac{\delta \hat{D}^2}{\|\delta\| \hat{D} + \rho(t)} \right\| < \left\| \frac{\delta \hat{D}^2}{\|\delta\| \hat{D}} \right\| = \hat{D} \in L_\infty.$$

Lemma 5.

$$\lim_{t \rightarrow \infty} e = 0$$

(Proof)

From definitions and Lemma 4, we have $\dot{\delta} \in L_\infty$. Since $\delta, \beta \in L_2$, by Barbalat's Lemma(Krstic et al., 1995; Slotine & Li, 1991) we have $\lim_{t \rightarrow \infty} \delta = 0$ and $\lim_{t \rightarrow \infty} \beta = 0$. This means $\lim_{t \rightarrow \infty} \tilde{v} = 0$. By Lemma1 $\lim_{t \rightarrow \infty} e_B = 0$. Since $\lim_{t \rightarrow \infty} \tilde{v} = 0$ and

$$\tilde{v}_{M1} = -\dot{e}_{M1} - K_{M1}e_{M1},$$

$\lim_{t \rightarrow \infty} e_{M1} = 0$. Then $\lim_{t \rightarrow \infty} e = 0$.

From above 5 Lemmas and next Lemma the proof of Theorem 1 is completed.

Lemma 6.

$$\lim_{t \rightarrow \infty} \lambda_M = \lambda_M^*$$

(Proof)

From (19), Lemma 3 and Lemma 4, $\dot{\delta} \in L_\infty$. And from definitions, $\dot{\beta} \in L_\infty, \dot{v} \in L_\infty$. Then $\ddot{q} \in L_\infty, \ddot{R}$ and $\ddot{v}_c \in L_\infty$. These lead us to $\dot{Y}_1(q, \dot{q}, \chi, \dot{\chi} + \dot{\beta}) \in L_\infty$.

Differentiating both sides of (26), we have $\dot{\tilde{\lambda}}_M \in L_\infty$, that is $\dot{\lambda}_M \in L_\infty$. Then, by above Lemmas and definition of $\beta_M, \dot{\beta}_M \in L_\infty$. This shows that $\dot{\beta}_M$ is uniformly continuous. And $\beta_M \rightarrow 0$ is shown in previous Lemma. Therefore from Barbalat's Lemma(Krstic et al., 1995; Slotine & Li, 1991) we have $\lim_{t \rightarrow \infty} \dot{\beta}_M = 0$. Since $[\hat{J}_{M1} \hat{J}_{M2}]^T$ in (15) is full column rank, we have

$$\lim_{t \rightarrow \infty} \tilde{\lambda}_M = 0.$$

3.3 Control laws for the system only with the dynamic uncertainties

In this section we propose the robust and adaptive position/force control scheme of the mobile manipulators with only the dynamic uncertainties. Since kinetic parameters are known, the Jacobian matrix $\hat{J}_M(q, \hat{\psi})$ has no uncertainties. Therefore (15) and \hat{R} are replaced with

$$\begin{aligned} \dot{\beta}_M &= -\alpha_1 \beta_M - \alpha_1 [J_{M1} \ J_{M2}]^T \tilde{\lambda}_M, \\ R &= \begin{bmatrix} I_k & 0 \\ 0 & I_l \\ -J_{M2}^{-1} J_{M0} f_B \varphi^{-1} & -J_{M2}^{-1} J_{M1} \end{bmatrix}. \end{aligned} \tag{27}$$

Then the robust adaptive control scheme proposed in (Narikiyo et al., 2008) can be applied to the system with dynamic uncertainties. This control scheme is shown in the following theorem.

Theorem 2. *Let the kinematic parameters be known. Applying the following control law and adaptive laws to the mobile manipulator (4) and (5),*

$$\begin{aligned} \tau &= B_1^{-1} [-K_d \delta - F + Y_1(q, \dot{q}, \chi, \dot{\chi}) \hat{p} \\ &\quad - \left(\frac{\partial V_1}{\partial q} S(q_B) \right)^T + \tilde{J}_M^T (-\lambda_M^* + \alpha_2 \tilde{\lambda}_M)] \\ \dot{\hat{p}} &= -\Gamma Y_1^T(q, \dot{q}, \chi, \dot{\chi}) \delta \\ \dot{D} &= \gamma \|\delta\| \end{aligned} \tag{28}$$

then internal signals are bounded and

$$\lim_{t \rightarrow \infty} e = 0, \lim_{t \rightarrow \infty} \tilde{\lambda}_M = 0, \tag{29}$$

where

$$F(t) = \frac{\delta \dot{D}^2}{\|\delta\| \dot{D} + \rho(t)}.$$

Substituting (28) into (4), we can obtain the following closed loop system.

$$\begin{aligned} M_1 \dot{\delta} &= -(C_1 + K_d) \delta + Y_1(q, \dot{q}, \chi, \dot{\chi}) \tilde{p} - \left(\frac{\partial V_1}{\partial q} S(q_B) \right)^T \\ &\quad + (1 + \alpha_2) \tilde{J}_M^T \tilde{\lambda}_M - (F + d_1) \\ \dot{\hat{p}} &= -\Gamma Y_1^T(q, \dot{q}, \chi, \dot{\chi}) \delta \\ \dot{D} &= \gamma \|\delta\| \\ \dot{\beta}_M &= -\alpha_1 \beta_M - \alpha_1 [J_{M1} \ J_{M2}]^T \tilde{\lambda}_M \end{aligned} \tag{30}$$

Proof of the theorem 2 is completed by the following Lemmas as similar to the proof of Theorem 1.

Lemma 7. *For the closed loop system, $\delta, \beta \in L_2, \tilde{v}, R\tilde{s}, \hat{p}, e_{M1}, \dot{e}_{M1}, v_c, \chi, q, \dot{q} \in L_\infty$ and*

$$\lim_{t \rightarrow \infty} e_1 = 0, \lim_{t \rightarrow \infty} e_3 = 0.$$

(Proof)

We set V_2 as

$$V_2 = V_1 + \frac{1}{2}\delta^T M_1 \delta + \frac{1 + \alpha_2}{2\alpha_1} \beta^T \beta + \frac{1}{2} \tilde{p}^T \Gamma^{-1} \tilde{p} + \frac{1}{2\gamma} \tilde{D}^2. \tag{31}$$

Differentiating V_2 along (30), we have

$$\begin{aligned} \dot{V}_2 &= \frac{\partial V_1}{\partial q} S(q_B)(v_c + \tilde{v}) + \frac{\partial V_1}{\partial q^*} S(q_B^*) v^* \\ &\quad - \delta^T K_d \delta - (1 + \alpha_2) \beta^T \beta - \delta^T S^T(q_B) \left(\frac{\partial V_1}{\partial q} \right)^T \\ &\quad + (1 + \alpha_2) \tilde{\lambda}_M \tilde{J}_M R \tilde{s} - \delta^T (F + d_1). \end{aligned}$$

Furthermore, by using definitions of $V_1 = V_1(q_B, q_B^*)$ and δ ,

$$\frac{\partial V_1}{\partial q} S(q_B) \tilde{v} = \frac{\partial V_1}{\partial q} S(q_B) \delta$$

is derived and by using the relation

$$\begin{aligned} \tilde{J}_M R &= \begin{bmatrix} J_{M0} f_B \varphi^{-1} & J_{M1} & J_{M2} \end{bmatrix} \begin{bmatrix} I_k & 0 \\ 0 & I_l \\ -J_{M2}^{-1} J_{M0} f_B \varphi^{-1} & -J_{M2}^{-1} J_{M1} \end{bmatrix} \\ &= \begin{bmatrix} 0_{(m-l) \times k} & 0_{(m-l) \times l} \end{bmatrix}, \end{aligned}$$

we have

$$\dot{V}_2 = -K_1 e_1^2 - \frac{K_3}{K_2} \sin^2 e_3 - \delta^T K_d \delta - (1 + \alpha_2) \beta^T \beta - \delta^T (F + d_1). \tag{32}$$

$F(t)$ and adaptive laws lead the right hand of (32) to

$$\dot{V}_2 < -K_1 e_1^2 - \frac{K_3}{K_2} \sin^2 e_3 - \delta^T K_d \delta - (1 + \alpha_2) \beta^T \beta + \rho(t). \tag{33}$$

Integrating both side of this inequality and using definition of $\rho(t)$, we have

$$\begin{aligned} V_2(t) - V_2(0) &< -K_1 \int_0^t e_1^2 d\tau - \frac{K_3}{K_2} \int_0^t \sin^2 e_3 d\tau \\ &\quad - \int_0^t \delta^T K_d \delta d\tau - (1 + \alpha_2) \int_0^t \beta^T \beta d\tau + a < \infty. \end{aligned} \tag{34}$$

This shows

$$V_2(t) < V_2(0) + a < \infty. \tag{35}$$

Therefore, $V_2(t)$ is bounded, that is, $e_1, e_2, \delta, \beta, \tilde{p}, \tilde{D} \in L_\infty$, and $e_1, \sin e_3, \delta, \beta \in L_2$. From definitions of variables \tilde{v} , we have $R\tilde{s}, \hat{p}, \hat{D} \in L_\infty$. From (12) and definitions of v and v_c ,

$\tilde{v}_{M1} = -\dot{e}_{M1} - K_{M1}e_{M1} \in L_\infty$. Then $e_{M1}, \dot{e}_{M1} \in L_\infty$. Furthermore, from (12) and Assump.3, we have $v_c, \chi \in L_\infty$ and $e_{M1}, \dot{e}_{M1} \in L_\infty$. From Assump.2, we have $q_M, \dot{q}_M \in L_\infty$. Similarly from $\tilde{v}, v_c \in L_\infty$ and Assump.2, we have $\dot{q}_B, \dot{e}_B \in L_\infty$. Therefore $q, \dot{q} \in L_\infty$. Finally, from $e_1, \sin e_3 \in L_2$ and Barbalat's Lemma(Slotine & Li, 1991), we have

$$\lim_{t \rightarrow \infty} e_1 = 0, \lim_{t \rightarrow \infty} e_3 = 0.$$

Lemma 8. Let $\hat{M}_1 = M_1(\hat{p})$. If there exist α_1, α_2 such that

$$\{\alpha_1 \hat{M}_1 \text{Blockdiag}(0_k, I_m) + (1 + \alpha_2)I_{k+m}\}$$

is nonsingular, then $\tilde{\lambda}_M \in L_\infty$.

(Proof)

From (30) we have

$$(1 + \alpha_2)\bar{J}_M^T \tilde{\lambda}_M = M_1(R\dot{s} + \dot{R}s) + M_1\dot{\beta} + (C_1 + K_d)\delta - Y_1(q, \dot{q}, \chi, \dot{\chi})\tilde{p} + (F + d_1).$$

By using the relation

$$Y_1(q, \dot{q}, \chi, \dot{\chi})\tilde{p} = Y_1(q, \dot{q}, \chi, \dot{\chi} + \dot{\beta})\tilde{p} - \{\hat{M}_1(q) - M_1(q)\}\dot{\beta},$$

above equation is converted into

$$\begin{aligned} & \{\alpha_1 \hat{M}_1 \text{Blockdiag}(0_k, I_m) + (1 + \alpha_2)I_{k+m}\} \bar{J}_M^T \tilde{\lambda}_M \\ & = M_1(R\dot{s} + \dot{R}s) + (C_1 + K_d)\delta \\ & - Y_1(q, \dot{q}, \chi, \dot{\chi} + \dot{\beta})\tilde{p} - \alpha_1 \hat{M}_1 \beta + (F + d_1). \end{aligned} \tag{36}$$

Multiplying (36) by $\bar{J}_M M_1^{-1}$ from left, we have

$$\begin{aligned} & \bar{J}_M M_1^{-1} \{\alpha_1 \hat{M}_1 \text{Blockdiag}(0_k, I_m) + (1 + \alpha_2)I_{k+m}\} \\ & \times \bar{J}_M^T \tilde{\lambda}_M = \bar{J}_M \left[\dot{R}s + M_1^{-1} \{(C_1 + K_d)\delta \right. \\ & \left. - Y_1(q, \dot{q}, \chi, \dot{\chi} + \dot{\beta})\tilde{p} - \alpha_1 \hat{M}_1 \beta + (F + d_1)\} \right]. \end{aligned} \tag{37}$$

Furthermore, since (12) and Assump.3 lead to $\dot{v}_c \in L_\infty$ and $\dot{\chi} + \dot{\beta} = \dot{v}_c$, we have

$$Y_1(q, \dot{q}, \chi, \dot{\chi} + \dot{\beta}) \in L_\infty.$$

Therefore, if α_1 and α_2 are selected such that

$$\{\alpha_1 \hat{M}_1 \text{Blockdiag}(0_k, I_m) + (1 + \alpha_2)I_{k+m}\}$$

is nonsingular, then $\tilde{\lambda}_M \in L_\infty$.

Since from these Lemmas and Barbalat's Lemma(Slotine & Li, 1991) we have

$$\lim_{t \rightarrow \infty} e = 0, \lim_{t \rightarrow \infty} \tilde{\lambda}_M = 0,$$

proof of the theorem is completed.

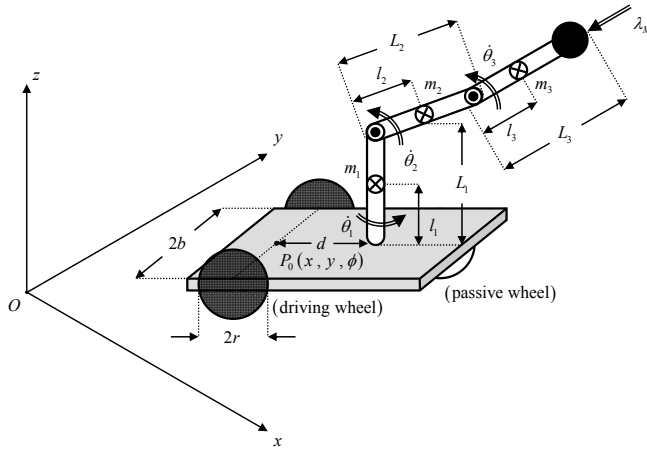

Fig. 3. Mobile manipulator used for simulations and experiments

4. Simulations and experiments

4.1 Mobile manipulator

Schematic model of mobile manipulator used for simulations and experiments is shown in Fig.3. This mobile manipulator consists of 3 wheel mobile base and 3 link manipulator. m_B, m_W and m_1, m_2, m_3 denote masses of base, wheels and manipulator links, respectively. I_B, I_W, I_m and I_1, I_2, I_3 denote moment of inertia of base, wheel axis, wheel and manipulator links, respectively. These dynamic parameters are unknown. Kinematic parameters are denoted in Fig.3. Numerical values of kinematic parameters are estimated as follows. $2b = 0.316, r = 0.098, d = 0.11, L_1 = 0.143, L_2 = 0.19, L_3 = 0.342, l_1 = 0.0715, l_2 = 0.095, l_3 = 0.171$. On the other hand, dynamic parameters are hardly identified. However, in simulations we use following estimates; $m_B = 5.0, m_W = 1.25, I_B = 0.137, I_W = 0.00313, I_m = 0.00582, 2b = 0.316, m_1 = 1.25, m_2 = 0.5, m_3 = 0.75, I_1 = 0.00259, I_2 = 0.00173, I_3 = 0.00201$. Unknown parameter vector $p_1 \in R^{26}$ is consisting of these parameters and is given by

$$p_1 = [p_1^1, p_2^1, \dots, p_{26}^1]^T,$$

where

$$\begin{aligned} p_1^1 &= \frac{r^2}{4}(m_B + m_1 + m_2 + m_3), \\ p_2^1 &= \frac{r^2 d}{2b}(m_B + m_1 + m_2 + m_3), \\ p_3^1 &= \frac{r^2}{4b^2} \left\{ (m_B + m_1 + m_2 + m_3)d^2 + I_B + 2I_W \right\}, \\ p_4^1 &= m_W r^2 + I_m, p_5^1 = (m_2 l_2 + m_3 L_2)g, \\ p_6^1 &= \frac{r}{2}(m_2 l_2 + m_3 L_2), p_7^1 = \frac{1}{2}(m_2 l_2^2 + m_3 L_2^2), \end{aligned}$$

$$\begin{aligned}
 p_8^1 &= \frac{r^2}{4b}(m_2l_2 + m_3L_2), p_9^1 = \frac{rd}{2b}(m_2l_2 + m_3L_2), \\
 p_{10}^1 &= \frac{r}{4b}(m_2l_2^2 + m_3L_2^2), p_{11}^1 = \frac{r^2d}{4b^2}(m_2l_2 + m_3L_2), \\
 p_{12}^1 &= \frac{r^2}{8b^2}(m_2l_2^2 + m_3L_2^2), p_{13}^1 = m_3l_3g, p_{14}^1 = \frac{1}{2}m_3rl_3, \\
 p_{15}^1 &= m_3L_2l_3, p_{16}^1 = \frac{1}{2}m_3l_3^2, p_{17}^1 = \frac{1}{4b}m_3r^2l_3, \\
 p_{18}^1 &= \frac{1}{2}m_3rdl_3, p_{19}^1 = \frac{1}{2b}m_3rl_3L_2, p_{20}^1 = \frac{1}{4b}m_3rl_3^2, \\
 p_{21}^1 &= \frac{1}{4b^2}m_3r^2dl_3, p_{22}^1 = \frac{1}{4b^2}m_3r^2L_2l_3, \\
 p_{23}^1 &= \frac{1}{8b^2}m_3r^2l_3^2, p_{24}^1 = I_1, p_{25}^1 = I_2, p_{26}^1 = I_3.
 \end{aligned}$$

Generalized coordinates are also shown in this Figure. Base coordinates (x, y, ϕ) can be detected by 3D camera system and others can be detected by encoders. Nonholonomic constraints imposed on this system are written as follows.

$$\begin{aligned}
 \dot{x} \sin \phi - \dot{y} \cos \phi &= 0 \\
 \dot{x} \cos \phi + \dot{y} \sin \phi + b\dot{\phi} &= r\dot{\theta}_r \\
 \dot{x} \cos \phi + \dot{y} \sin \phi - b\dot{\phi} &= r\dot{\theta}_l
 \end{aligned}$$

Coordinates (θ_r, θ_l) are related with forward velocity u and angular velocity ω as

$$\begin{bmatrix} \dot{\theta}_r \\ \dot{\theta}_l \end{bmatrix} = \begin{bmatrix} \frac{1}{r} & \frac{b}{r} \\ \frac{1}{r} & -\frac{b}{r} \end{bmatrix} \begin{bmatrix} u \\ \omega \end{bmatrix}.$$

Then (θ_r, θ_l) can be eliminated from the equations of motion by using (u, ω) as generalized velocities. Therefore, kinematic equations (8) are given by

$$\begin{bmatrix} \dot{x} \\ \dot{y} \\ \dot{\phi} \\ \dot{\theta}_1 \end{bmatrix} = \begin{bmatrix} \frac{r}{2} \cos \phi & \frac{r}{2} \cos \phi & 0 \\ \frac{r}{2} \sin \phi & \frac{r}{2} \sin \phi & 0 \\ \frac{r}{2b} & -\frac{r}{2b} & 0 \\ 0 & 0 & 1 \end{bmatrix} \begin{bmatrix} v_r \\ v_l \\ v_{M1} \end{bmatrix}. \tag{38}$$

4.2 Simulation for the system with both the kinetic and dynamic uncertainties

Mobile manipulator used for simulation is shown in Fig.3. In this simulation both the kinematic and dynamic parameters are all unknown.

In this simulation, the mobile base is controlled to track to the desired position/orientation trajectory on the floor and the end-effector of the manipulator is controlled to be constrained on the ceiling with desired reaction force. Then, nonholonomic constraints imposed on this system are same as shown before. On the other hand, holonomic constraint imposed on this system is

$$\Phi(q) = L_1 + L_2 \sin \theta_2 + L_3 \sin(\theta_2 + \theta_3) - L = 0.$$

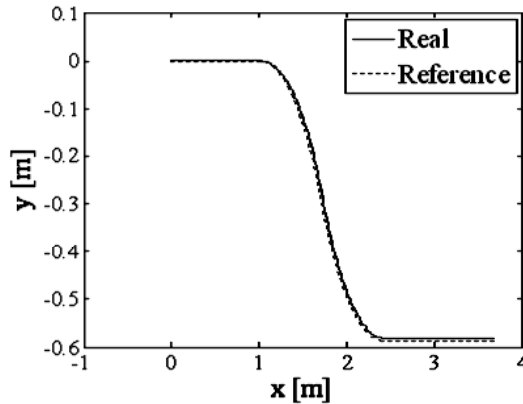

Fig. 4. Trajectory on (x, y) plane

This holonomic constraint represents that the end-effector of manipulator is constrained on the ceiling.

Desired trajectory of the manipulator is given by

$$\theta_1^* = 1.2(1 - \cos 0.25t), \theta_2^* = \frac{\pi}{4}$$

and desired force trajectory λ_M^* is 10. Desired position trajectories of the base $q_B^* = [x^* \ y^* \ \phi^*]^T$ are generated by the reference robot given by

$$\dot{q}^* = f_B(q_B^*)\eta^*. \tag{39}$$

To obtain the mixed straight and curved line, desired velocities $\eta^* = [u^* \ \omega^*]^T$ are defined as follows.

$$\begin{cases} u^* = 0.1(1 - \cos \frac{\pi}{2.5}t) \\ \omega^* = 0 \end{cases} \quad (0 \leq t < 2.5) \quad \begin{cases} u^* = 0.2 \\ \omega^* = 0 \end{cases} \quad (2.5 \leq t < 5) \\ \begin{cases} u^* = 0.1(1 + \cos \frac{\pi}{2.5}t) \\ \omega^* = 0 \end{cases} \quad (5 \leq t < 7.5) \quad \begin{cases} u^* = 0.1\pi(1 - \cos \frac{2\pi}{2.5}t) \\ \omega^* = -u^* \end{cases} \quad (7.5 \leq t < 10) \\ \begin{cases} u^* = 0.1\pi(1 - \cos \frac{2\pi}{2.5}t) \\ \omega^* = u^* \end{cases} \quad (10 \leq t < 12.5) \quad \begin{cases} u^* = 0.1(1 + \cos \frac{\pi}{2.5}t) \\ \omega^* = 0 \end{cases} \quad (12.5 \leq t < 15) \\ \begin{cases} u^* = 0.2 \\ \omega^* = 0 \end{cases} \quad (15 \leq t) \end{cases}$$

Initial conditions are $\dot{q}(0) = 0$, $q(0) = [0 \ 0 \ -\pi/20 \ 0; \pi/4, \pi/3]^T$ and $\hat{p}_1(0) = 0, \hat{a}_i(0) = 0, \hat{\theta}_i(0) = 0, \hat{D}(0) = 0, \hat{\psi}(0) = [0.1 \ 0.1]^T$. Disturbance vector is $d_1(q) = [1 \ 1 \ 0.5 \ 0.5 \ 0.5]^T$. For this system design parameters are assigned as $K_d = 10 \times I_4, \Gamma_1 = \Gamma_2 = \gamma = \Lambda_1 = \Lambda_2 = 1, \alpha_1 = 5 \times I_3, \alpha_2 = 25, \gamma_1 = \gamma_2 = 100, K_1 = K_2 = K_3 = K_{M11} = K_{M12} = 10$ and

$$\rho(t) = \frac{1}{(1 + \frac{t}{10})^2}.$$

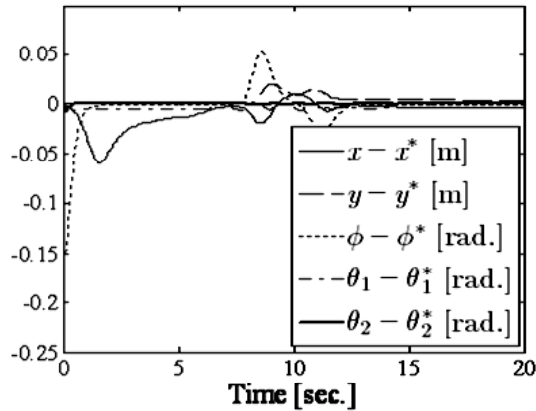

Fig. 5. Position tracking errors

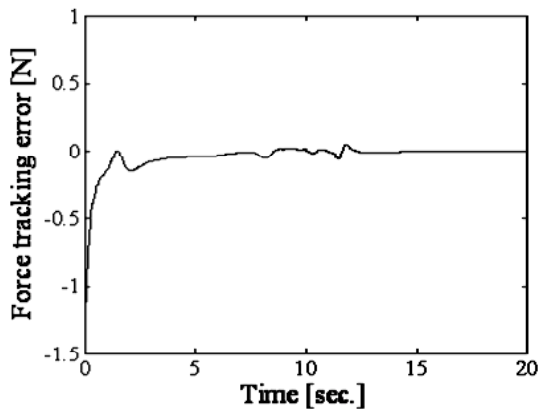

Fig. 6. Force tracking error

Fig.4 shows a desired trajectory and a tracking trajectory. Broken line shows a desired trajectory generated by the reference robot and solid line shows a tracking trajectory of the mobile manipulator. In spite of quite a large initial tracking error, tracking error is converged sufficiently small. Fig.5 and Fig.6 show the trajectory tracking errors of each coordinate and force tracking error, respectively.

4.3 Experiments

Fig.7 and 8 show a snapshot of experiments and the end-effector of the mobile manipulator respectively. In order to reduce the adverse effects of friction from the wall rolling ball is mounted on the top of the end-effector and to detect the reaction force from the wall force sensor is equipped under the rolling ball. In experiments mobile manipulator is controlled to move on the straight line parallel to the wall with assigned speed and simultaneously end-effector is controlled to press against the wall with assigned force. Since the end-effector



Fig. 7. Snapshot of experiments

is constrained on the wall, following holonomic constraint $\Phi(q)$ is imposed.

$$\Phi(q) = y + d \sin \phi + \{L_2 \cos \theta_2 + L_3 \cos(\theta_2 + \theta_3)\} \times \sin(\phi + \theta_1) - L = 0,$$

where L denotes distance between the wall and P_0 which is center of wheel axis. Then θ_2 is also eliminated by using the holonomic constraint.

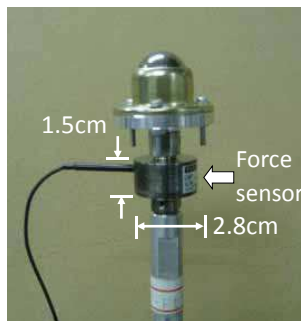

Fig. 8. End-effector

4.3.1 Application to the system only with the dynamic uncertainties

In case when kinetic parameters are known, we can apply control laws given in Theorem 2 and we can use estimates of kinematic parameters shown in Subsection 4.1. Control parameters are give as follows. $K_d = 5, K_1 = 5, K_2 = 50, K_3 = 10, K_{M1} = [10 \ 10], \alpha_1 = 5, \alpha_2 = 5, \Gamma = 0.2, \gamma = 1$. $\rho(t)$ is given as

$$\rho(t) = \frac{1}{(t/K_\rho + 1)^2},$$

where K_ρ is constant and is assigned 500 in this experiments.

Experimental situation is shown in Fig.7. Mobile manipulator is controlled to move on the straight line with constant speed 5cm/sec . End-effector is controlled to press against the wall

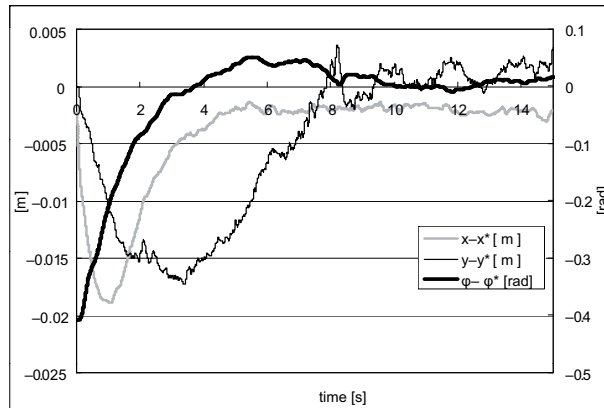

Fig. 9. Position error trajectories

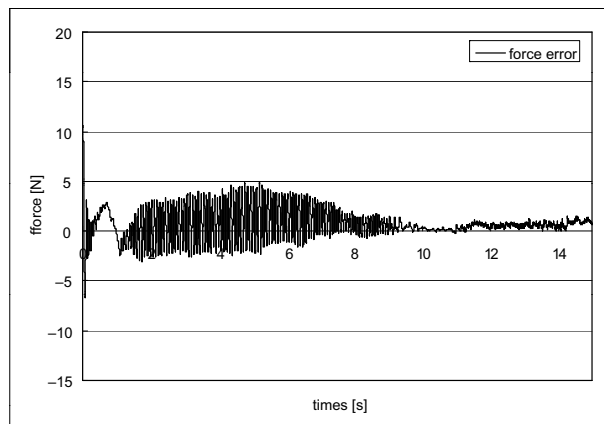

Fig. 10. Force error trajectory

with constant force 2N. Fig.9 shows position error trajectories of the mobile base. Even though the mobile base is declined about 20 degrees parallel to the wall initially, position errors are settled to the neighbourhood of origin. Fig.10 shows force error. Also the force error is settled similarly to the position error trajectories.

4.3.2 Application to the system with both the kinetic and dynamic uncertainties

In this experiment we assume that not only dynamic parameters but also kinematic parameters are unknown. Then we apply control laws given in Theorem 1. In these control laws, unknown parameters are defined as follows.

$$a_1 = \frac{1}{r}, a_2 = \frac{b}{r},$$

$$\theta_{p1} = \begin{bmatrix} \frac{r}{2} \\ \frac{r}{2b} \end{bmatrix}, \theta_{p2} = \begin{bmatrix} \frac{r}{2} \\ \frac{r}{2b} \end{bmatrix}.$$

Furthermore, from Property 6

$$\begin{aligned} \bar{J}_M^T(q)\lambda_M &= Z_1(q, \lambda_M)\psi \\ &= \begin{bmatrix} \lambda_M \sin \phi & \lambda_M \cos \phi & \lambda_M \cos(\phi + \theta_1) \cos \theta_2 \\ \lambda_M \sin \phi & -\lambda_M \cos \phi & -\lambda_M \cos(\phi + \theta_1) \cos \theta_2 \\ 0 & 0 & 0 \\ 0 & 0 & 0 \\ 0 & 0 & 0 \\ \lambda_M \cos(\phi + \theta_1) \cos(\theta_2 + \theta_3) & 0 \\ -\lambda_M \cos(\phi + \theta_1) \cos(\theta_2 + \theta_3) & 0 \\ 0 & \lambda_M \cos(\phi + \theta_1) \cos \theta_2 \\ 0 & -\lambda_M \sin(\phi + \theta_1) \sin \theta_2 \\ 0 & 0 \\ 0 & 0 \\ 0 & 0 \\ -\lambda_M \sin(\phi + \theta_1) \sin(\theta_2 + \theta_3) \\ -\lambda_M \sin(\phi + \theta_1) \sin(\theta_2 + \theta_3) \end{bmatrix} \begin{bmatrix} \psi_1 \\ \psi_2 \\ \psi_3 \\ \psi_4 \\ \psi_5 \\ \psi_6 \end{bmatrix}, \end{aligned}$$

then we have

$$\begin{aligned} \psi_1 &= \frac{1}{2}r, \psi_2 = \frac{1}{2}\frac{rd}{b}, \psi_3 = \frac{1}{2}\frac{L_2d}{b}, \\ \psi_4 &= \frac{1}{2}\frac{L_3d}{b}, \psi_5 = L_2, \psi_6 = L_3. \end{aligned}$$

Therefore control scheme given in Theorem 1 is overparameterized scheme. Control

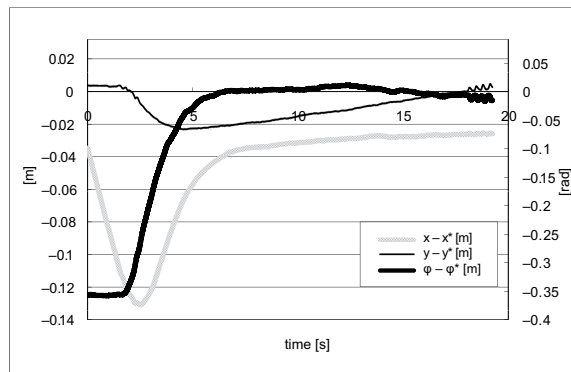

Fig. 11. Position error trajectories

parameters are as follows. $K_d = 5, K_1 = 5, K_2 = 50, K_3 = 10, K_{M1} = [10 \ 10], \alpha_1 = 5, \alpha_2 = 5, \Gamma_1 = 0.01, \Gamma_2 = 0.01, \gamma = 0.01, \gamma_1 = 10, \gamma_2 = 10, \Lambda_1 = 1, \Lambda_2 = 1$. $\rho(t)$ is same as that given in case when kinetic parameters are known.

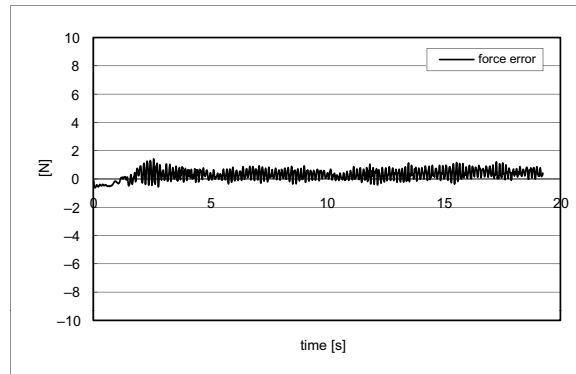

Fig. 12. Force error trajectory

As similar in case when kinetic parameters are known, mobile manipulator is controlled to move on the straight line with constant speed 5cm/sec . End-effector is controlled to press against the wall with constant force 2N . Fig.11 shows position error trajectories of the mobile base. Similarly to the previous experiment, even though the mobile base is declined about 20 degrees to the wall initially, position errors are settled to the neighbourhood of origin. Fig.12 shows force error. Also the force error is settled similarly to the position error trajectories.

5. Concluding remark

In this study robust adaptive hybrid position/force control problems have been investigated. Proposed control schemes can be applied to the system which has not only dynamic uncertainties but also both the kinematic and dynamic uncertainties. Furthermore unknown disturbances have been considered. It is guaranteed theoretically that the tracking position errors and force errors are asymptotically converged to zero and all internal signals are bounded. This means that all estimated parameters are also bounded and still remained to be small. However, some estimated parameters are monotonically increasing, especially \hat{D} . Since \hat{D} is updated by

$$\dot{\hat{D}} = \gamma \|\delta\|,$$

\hat{D} is increased in so far as $\delta \neq 0$. Furthermore in this experiments sensor noise and unmodeled nonlinearities hinder the proposed control schemes from achievement of the perfect regulation $\delta = 0$. These lead us to the fact that the estimate \hat{D} becomes large with the passage of time. Therefore, in the practical situation to avoid the numerical difficulties of \hat{D} resulted from the long-term control, \hat{D} should be set constant value when the estimate \hat{D} exceeds the designated threshold or $\|\delta\|$ should be set 0 in the computation of the adaptive laws if $\|\delta\| < \epsilon$, where ϵ is specified small number.

Usefulness of the proposed control schemes has been demonstrated by experiments. Especially, since environmental uncertainties can be considered as the kinematic uncertainties, the proposed control scheme given by Theorem 1 can be applied to the case when environmental uncertainties arise.

6. Acknowledgements

This study was supported in part by both the scientific Research Fund (B)19360110 and Hitech Research Center, Project for Private University from the Ministry of Education, Culture, Sports, Science and Technology.

7. References

- Chang, Y. C. & Chen, B. S. (2002). Adaptive tracking control for nonholonomic Caplygin systems. *IEEE Trans. Control Systems Technology*, Vol. 10, No. 1, pp. 96-104
- Cheah, C. C.;Kawamura, S. & Arimoto, S. (2003). Stability of Hybrid Position and Force Control for Robotic Manipulator with Kinematic and Dynamics Uncertainties. *Automatica*, Vol.39, pp.847-855
- Dong, W. (2002). On trajectory and force tracking control of constrained mobile manipulators with parameter uncertainty. *Automatica*, Vol. 32, pp. 1475-1484
- Fukao, T.;Hasegawa, H. & Adachi, H. (2000). Adaptive Tracking Control of a Nonholonomic Mobile Robot. *IEEE Trans. Robotics and Automation*, Vol. 16, No. 5, pp. 609-615
- Kristic, M.;Kanellakopoulos, I. & Kokotovic, P. (1995). *Nonlinear and Adaptive Control Design*, John Wiley and Sons
- Li, Z.;Yang, J.;Luo, J.;Wang, Z. & Ming, A. (2007). Robust motion/force control of nonholonomic mobile manipulators using hybrid joints. *Advanced Robotics*, Vol. 21, No. 11, pp. 1231-1252
- Li, Z.;Adams, M. & Wijesoma, W. S. (2008). Robust Adaptive control of uncertain force/motion constrained nonholonomic mobile manipulators. *Automatica*, Vol. 44, pp. 776-784
- Murray, R. M.; Li, Z. & Sastry, S. S. (1993). *An Introduction to Robotic Manipulation*, CRC Press
- Narikiyo, T.; Kawanishi, M. & Nakagawa, M. (2008). Robust Adaptive Position/Force Control of Mobile Manipulators with Dynamic Uncertainties, *Proceedings of IASTED CA2009*, pp. 264-269, ISBN, Cambridge, UK
- Narikiyo, T.; Kawanishi, M. & Mizuno, T. (2009). Robust Adaptive Position/Force Control of Mobile Manipulators with Kinematic and Dynamic Uncertainties, *Proceedings of ICROS-SICE International Joint Conference*, pp. 4704–4709, Fukuoka, Japan
- Oya, M.;Su, C. Y.& Katoh, R. (2003). Robust Adaptive Motion/Force Tracking Control of Uncertain Nonholonomic Mechanical Systems. *IEEE Trans. Robotics and Automation*, Vol. 19, No. 1, pp. 175-181
- Slotine, J-J. E. & Li, W. (1991). *Applied Nonlinear Control*, Prentice Hall
- Su, C. Y.;Stepanenko, Y. & Goldenberg, A. A. (1999). Reduced Order Model and Robust Control Architecture for Mechanical Systems with Nonholonomic Pfaffian Constraints. *IEEE Trans. Systems, Man, and Cybernetics-Part A*, Vol. 29, No. 3, pp. 307-313
- Yamamoto, Y. & Yun, X. (1996). Effect of the Dynamic Interaction on Coordinated Control of Mobile Manipulators. *IEEE Trans. Robotics and Automation*, Vol. 12, No. 5, pp.816-824
- Yuan, J. (1997). Adaptive Control of a Constrained Robot-Ensuring Zero Tracking and Zero Force Errors. *IEEE Trans. Automatic Control*, Vol. 42, No. 12, pp. 1709-1714

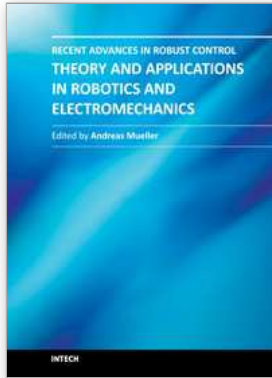

Recent Advances in Robust Control - Theory and Applications in Robotics and Electromechanics

Edited by Dr. Andreas Mueller

ISBN 978-953-307-421-4

Hard cover, 396 pages

Publisher InTech

Published online 21, November, 2011

Published in print edition November, 2011

Robust control has been a topic of active research in the last three decades culminating in H_2/H_∞ and μ design methods followed by research on parametric robustness, initially motivated by Kharitonov's theorem, the extension to non-linear time delay systems, and other more recent methods. The two volumes of Recent Advances in Robust Control give a selective overview of recent theoretical developments and present selected application examples. The volumes comprise 39 contributions covering various theoretical aspects as well as different application areas. The first volume covers selected problems in the theory of robust control and its application to robotic and electromechanical systems. The second volume is dedicated to special topics in robust control and problem specific solutions. Recent Advances in Robust Control will be a valuable reference for those interested in the recent theoretical advances and for researchers working in the broad field of robotics and mechatronics.

How to reference

In order to correctly reference this scholarly work, feel free to copy and paste the following:

Tatsuo Narikiyo and Michihiro Kawanishi (2011). Robust Adaptive Position/Force Control of Mobile Manipulators, Recent Advances in Robust Control - Theory and Applications in Robotics and Electromechanics, Dr. Andreas Mueller (Ed.), ISBN: 978-953-307-421-4, InTech, Available from: <http://www.intechopen.com/books/recent-advances-in-robust-control-theory-and-applications-in-robotics-and-electromechanics/robust-adaptive-position-force-control-of-mobile-manipulators>

INTECH
open science | open minds

InTech Europe

University Campus STeP Ri
Slavka Krautzeka 83/A
51000 Rijeka, Croatia
Phone: +385 (51) 770 447
Fax: +385 (51) 686 166
www.intechopen.com

InTech China

Unit 405, Office Block, Hotel Equatorial Shanghai
No.65, Yan An Road (West), Shanghai, 200040, China
中国上海市延安西路65号上海国际贵都大饭店办公楼405单元
Phone: +86-21-62489820
Fax: +86-21-62489821

© 2011 The Author(s). Licensee IntechOpen. This is an open access article distributed under the terms of the [Creative Commons Attribution 3.0 License](#), which permits unrestricted use, distribution, and reproduction in any medium, provided the original work is properly cited.