

Model Based μ -Synthesis Controller Design for Time-Varying Delay System

Yutaka Uchimura
Shibaura Institute of Technology
Japan

1. Introduction

Time delay often exists in engineering systems such as chemical plants, steel making processes, etc. and studies on time-delay system have long historical background. Therefore the system with time-delay has attracted many researchers' interest and various studies have been conducted. It had been a classic problem; however evolution of the network technology and spread of the Internet brought it back to the main stage. Rapid growth of computer network technology and wide spread of the Internet have been brought remarkable innovation to the world. They enabled not only the speed-of-light information exchange but also offering various services via Internet. Even the daily lives of people have been changed by network based services such as emails, web browsing, twitter and social networks.

In the field of motion control engineering, computer networks are utilized for connecting sensors, machines and controllers. Network applications in the machine industry are replacing bunch of traditional wiring, which is complex, heavy and requires high installation costs (Farsi et al., 1999). Especially, the weight of the signal wires increases the gas consumption of automobiles, which is nowadays not only an issue on the driving performance but also on the environmental issue.

Much research and development is also being conducted in application level, such as tele-surgery (Ghodoussi et al., 2002), tele-operated rescue robots (Yeh et al., 2008), and bilateral control with force feedback via a network (Uchimura & Yakoh, 2004). These applications commonly include sensors, actuators and controllers that are mutually connected and exchange information via a network.

When transmitting data on a network, transmission delays are accumulated due to one or more of the following factors: signal propagation delay, non-deterministic manner of network media access, waiting time in queuing, and so on. The delays sometimes become substantial and affect the performance of the system. Especially, delays in feedback not only weaken system performance, but also cause system unstable in the worst case. Various studies have investigated ways to deal the system with transmission delay. Time-delay systems belong to the class of functional differential equations which are infinite dimensional. It means that there exists infinite number of eigenvalues and conventional control methods developed for the linear time-invariant system do not always reach the most optimized solution.

Therefore many methods for the time-delay systems were proposed. A classic but prominent method is the Smith compensator (Smith, 1957). The Smith compensator essentially assumes that a time delay is constant. If the delay varies, the system may become unstable (Palmor, 1980). Vatanski et.al. (Vatanski et al., 2009) proposed a modified Smith predictor method by

measuring time varying delays on the network, which eliminates the sensor time delay (the delay from a plant to a controller). The gain (P gain) of the controller is adjusted based on the amount of time delay to maintain stability of the system. Passivity based control using scattering transformation does not require an upper bound of delay (Anderson & Spong, 1989); however, as noted in previous research (Yokokohji et al., 1999), the method tends to be conservative and to consequently deteriorate overall performance.

One of the typical approaches is a method based on robust control theory. Leung proposed to deal with time delay as a perturbation and a stabilizing controller was obtained in the framework of μ -synthesis (Leung et al., 1997). Chen showed a robust asymptotic stability condition by a structured singular value (Chen & Latchman, 1994). The paper also discussed on systems whose state variables include multiple delays.

Another typical approach is to derive a sufficient condition of stability using Lyapunov-Krasovskii type function (Kharitonov et al., 2003). The conditions are mostly shown in the form of LMI (Linear Matrix Inequality) (Mahmoud & Al-bluthairi, 1994) (Skelton et al., 1998). Furthermore, a stabilizing controller for a time invariant uncertain plant is also shown in the form of LMI (Huang & Nguang, 2007). However, Lyapunov-Krasovskii based approaches commonly face against conservative issues. For example, if the Lyapunov function is time independent (Verriest et al., 1993), the system tends to be very conservative. Thus, many different Lyapunov-Krasovskii functions are proposed to reduce the conservativeness of the controller (Yue et al., 2004) (Richard, 2003). Lyapunov-Krasovskii based methods deal with systems in the time domain, whereas robust control theory is usually described in the frequency domain.

Even though those two methods deal with the same object, their approaches seem to be very different. Zhang (Zhang et al., 2001) showed an interconnection between those two approaches by introducing the scaled small gain theory and a system named comparison system. The paper also examined on conservativeness of several stability conditions formulated in LMI and μ -synthesis based design, which concluded that μ -synthesis based controller was less conservative than other LMI based controllers. Detail of this examination is shown in the next section.

In fact, conservativeness really depends how much information of the plant is known. It is obvious that delay-independent condition is more conservative than delay-dependent condition. Generally, the more you know the plant, you possibly gain the chance to improve. For example, time delay on a network is not completely uncertain, in other words it is measurable. If the value of delay is known and explicitly used for control, performance would be improved. Meanwhile, in the model based control, the modeling error between the plant model and the real plant can affect the performance and stability of the system. However, perfect modeling of the plant is very difficult, because the properties of the real plant may vary due to the variation of loads or deterioration by aging. Thus modeling error is inevitable. The modeling error is considered to be a loop gain variation (multiplicative uncertainty). The error seriously affects the stability of the feedback system. In order to consider the adverse effect of the modeling error together with time delay, we exploited a μ -synthesis to avoid the instability due to uncertainty.

This chapter proposes a model based controller design with μ -synthesis for a network based system with time varying delay and the plant model uncertainty. For the time delay, the explicit modeling is introduced, while uncertainty of the plant model is considered as a perturbation based on the robust control theory.

The notations in this chapter are as follows: \mathbf{R} is the set of real numbers, \mathbf{C} is the set of complex numbers, $\mathbf{R}^{n \times m}$ is the set of all real $n \times m$ matrices, I_n is $n \times n$ identity matrix, W^T is the transpose of matrix W , $P > 0$ indicates that P is a symmetric and positive definite matrix,

$\|\cdot\|_\infty$ indicates H_∞ norm defined by $\|G\|_\infty := \sup_{\omega \in \mathbf{R}} \bar{\sigma}[G(j\omega)]$ where $\bar{\sigma}(M)$ is the maximum singular value of complex matrix M . Let (A, B, C, D) be a minimal realization of $G(s)$ with

$$G(s) = \left[\begin{array}{c|c} A & B \\ \hline C & D \end{array} \right]. \quad (1)$$

2. Related works and comparison on conservativeness

2.1 Stability analysis approaches, eigen values, small gain and LMI

Time-delay system attracts much interest of researchers and many studies have been conducted. In the manner of classic frequency domain control theory, the system seems to have infinite order, i.e. it has infinite poles, which makes it intractable problem. Since time delay is a source of instability of the system, stability analysis has been one of the main concerns. These studies roughly categorized into frequency domain based methods and time domain based methods. Frequency domain based methods include Nyquist criterion, Pade approximation and robust control theory such as H_∞ control based approaches.

Meanwhile time domain based methods are mostly offered with conditions which are associated with Lyapunov-Krasovskii functional. The condition is formulated in terms of LMI, hence can be solved efficiently.

Consider a time-delay system in (2),

$$\dot{x}(t) = Ax(t) + A_d x(t - \delta(t)) \quad (2)$$

where $x(t) \in \mathbf{R}^n$ which is a state variable, $A \in \mathbf{R}^{n \times n}$, $A_d \in \mathbf{R}^{n \times n}$ are parameters of state space model of a plant and $\delta(t)$ corresponds to the delay on transmission such as network communication delay.

Much interest in the past literature has focused on searching less conservative conditions. Conservativeness is often measured by the amount of $\delta(t)$, that is, the larger $\delta(t)$ is the better. In fact, constraints on $\delta(t)$ plays an important role on conservativeness measure. Conservativeness strongly depends on the following constraints:

1. Delay dependent or independent. Whether or not there exists the upper bound of delay $\bar{\delta}$, where $\delta(t) < \bar{\delta}$.
2. $\delta(t)$ is time variant or time invariant (variable delay or constant delay).
3. The value of upper bound of $\delta(t)$, ν , where $\delta(t) < \nu$.

As for the first constraint, stability condition is often referred as delay-dependent/independent. If the stability condition is delay-independent, it allows amount of time-delay to be infinity.

2.2 Delay independent stability analysis in time domain

Verriest (Verriest et al., 1993) showed that the system in (2) is uniformly asymptotically stable, if there exist symmetric positive definite matrix P and Q such that

$$\begin{bmatrix} PA + A^T P + Q & P A_d \\ A_d^T P & -Q \end{bmatrix} < 0. \quad (3)$$

The condition (3) is a sufficient condition for delay-independent case. One may notice that the matrix form is similar to that of the bounded real lemma.

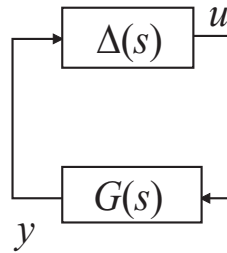

Fig. 1. Interconnection of a plant and time delay

Lemma 1 (Bounded real lemma): Assume $G(s)$ which is the transfer function of a system, i.e. $G(s) := C(sI - A)^{-1}B$. $\|G(s)\|_\infty < \gamma$, if and only if there exists a matrix $P > 0$,

$$\begin{bmatrix} PA + A^T P + \frac{C^T C}{\gamma} & P A_d \\ A_d^T P & -\gamma I_n \end{bmatrix} < 0. \tag{4}$$

Suppose (A, B, C, D) of system (2) is $(A, A_d, I_n, 0)$ and let $G(s) = (sI_n - A)^{-1}A_d$ be a transfer function of the system and $\gamma = 1$ in (4), (3) and (4) are identical. This fact implies that a system with time delay is stable regardless the value of time delay, if $\|G(s)\|_\infty < 1$. This condition corresponds to the small gain theorem.

Fig.1 shows an interconnection of system $G(s)$ and delay block $\Delta(s)$, where $u(t) = y(t - \delta(t))$. In the figure, $\Delta(s)$ is a block of time delay whose H_∞ norm $\|\Delta(s)\|_\infty$ is induced by (5).

$$\|\Delta(s)\|_\infty = \sup_{y \in L_2} \frac{\sqrt{\int_0^\infty u^T(t)u(t)dt}}{\sqrt{\int_0^\infty y^T(t)y(t)dt}} = \sup_{y \in L_2} \frac{\|u\|_2}{\|y\|_2} \tag{5}$$

Because the input energy to the delay block is same as the output energy, H_∞ norm of $\Delta(s)$ is equal to 1, i.e. $\|\Delta(s)\|_\infty = 1$. Hence, the interconnected system is stable because $\|G(s)\Delta(s)\|_\infty < 1$. This implies that if $\|G(s)\Delta(s)\|_\infty > 1$, the system becomes unstable when the delay exceeds the limitation. If the delay $\delta(t)$ is bounded by the maximum value $\bar{\delta}$, system in (2) is stable even if $\|G(s)\Delta(s)\|_\infty > 1$. Evaluation of conservativeness is often measured by the upper bound $\bar{\delta}$ for the given system. A condition which gives larger $\bar{\delta}$ is regarded as less conservative.

2.3 Delay dependent stability analysis with Lyapnov-Krasovskii functional

Delay independent stability condition is generally very conservative, because it allows infinite time delay and requires the system $G(s)$ to be small in terms of the system gain. However, the given system is not always $\|G(s)\|_\infty < 1$. For the system whose H_∞ norm is more than one, there exist an upper bound of delay. Generally, an upper bound of delay is given and stability conditions of the system with the upper bound are shown. There have been many studies on Lyapnov-Krasovskii based analysis for time varying delay system. These have been refining forms of Lyapnov-Krasovskii functional to reduce conservativeness. Following theorems are LMI based stability conditions for a system with time-varying delay.

Theorem 1 (Li & de Souza, 1996):

The system given in (6) with time-varying delay is asymptotically stable for any delay $\delta(t)$ satisfying condition (7) if there exist matrix $X > 0$ and constants $\beta_1 > 0$ and $\beta_2 > 0$ satisfying

(8)
$$\dot{x}(t) = Ax(t) + A_d x(t - \delta(t)) \tag{6}$$

$$0 \leq \delta(t) < \bar{\delta} \tag{7}$$

$$\begin{bmatrix} \Omega_1 & XA_dA & XA_dA_d \\ * & \beta_1^{-1}X & 0 \\ * & * & \beta_2^{-1}X \end{bmatrix} > 0 \tag{8}$$

where

$$\Omega_1 = -\bar{\delta}^{-1} \left[(A + A_d)^T X + X(A + A_d) \right] - (\beta_1^{-1} + \beta_2^{-1})X. \tag{9}$$

Theorem 2 (Park, 1999):

The system given in (6) with time-varying delay is asymptotically stable for any delay $\delta(t)$ satisfying condition (7) if there exist matrix $P > 0, Q > 0, V > 0$, and W such that

$$\begin{bmatrix} \Omega_2 & -W^T A_d & A^T A_d^T V & \Theta \\ * & -Q & A_d^T A_d^T B & 0 \\ * & * & -V & 0 \\ * & * & * & -V \end{bmatrix} > 0 \tag{10}$$

where

$$\Omega_2 = (A + A_d)^T P + P(A + B) + W^T B + B^T W + Q \tag{11}$$

$$\Theta = \bar{\delta}(W^T + P). \tag{12}$$

Theorem 3 (Tang & Liu, 2008):

The system given in (6) with time-varying delay which satisfies (7) is asymptotically stable for any delay $\delta(t)$ which satisfies (13), if there exist matrices $P > 0, Q > 0, Z > 0, Y$ and W such that the following linear matrix inequality (LMI) holds:

$$0 \leq \delta(t) < \bar{\delta}, \dot{\delta}(t) \leq \nu < 1 \tag{13}$$

$$\begin{bmatrix} \Omega_3 & -Y + PA_d + W^T & -Y \bar{d}A^T Z \\ * & -W - W^T - (1 - \nu)Q & -W dA_d^T Z \\ * & * & -Z & 0 \\ * & * & * & -Z \end{bmatrix} < 0 \tag{14}$$

where

$$\Omega_3 = PA + A^T P + Y + Y^T + Q. \tag{15}$$

In packet based networked system, the condition $\dot{\delta}(t) < 1$ implies that the preceding packet is not caught up by the successive packet.

2.4 Delay dependent stability analysis in frequency domain

In frequency domain based, Nyquist criterion gives necessary and sufficient condition and the eigen value based analysis described below is another option of the analysis.

Lemma 2 The system (2) is asymptotically stable for all $\delta \in [0, \bar{\delta}]$, if and only if $\psi(j\omega, \delta) \neq 0, \forall \omega > 0$ where $\psi(s, \delta) := (sI_n - A - A_d e^{-s\delta})$.

Corollary 1 The system (2) is asymptotically stable for all $\delta \in [0, \bar{\delta}]$, if and only if

$$\det[I_n - G(j\omega)\Phi(j\delta\omega)] \neq 0, \forall \omega \geq 0, \tag{16}$$

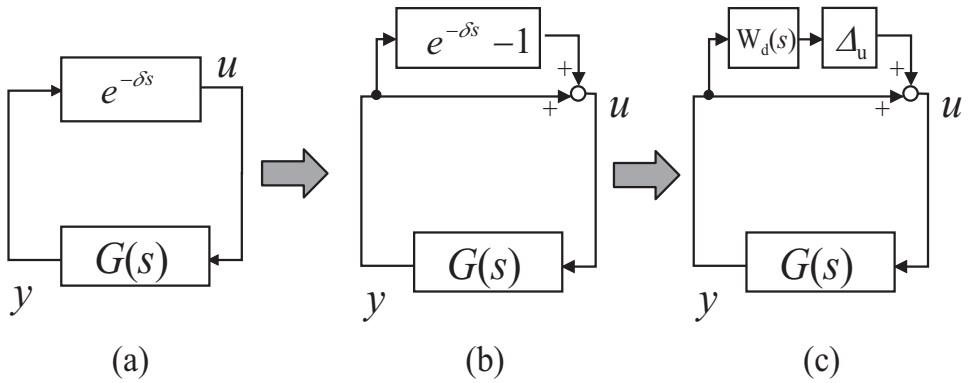

Fig. 2. Robust control based method

where $G(s) = F(sI_n - \bar{A})^{-1}H$, $A_d = HF$, $\bar{A} := A + A_d$ and $\Phi(\delta s) = \phi(\delta s)I_q$, $\phi(\delta s) = e^{-\delta s} - 1$. Lemma 2 and Corollary 1 requires solving a transcendental equation. Thus, another set $\Delta(j\omega)$ which covers $\Phi(\delta s)$ is chosen. This selection of set $\Delta(j\omega)$ seriously effects on conservativeness. Zhang proposed very less conservative method using modified Pade approximation. It gives very less conservative $\bar{\delta}$ which is very close to the Nyquist criterion.

The eigen value analysis including Pade based method can be only applicable for time invariant delay. For time variant delay, stability analysis with robust control based methods has been proposed.

The robust control based method regards a set $\Delta(j\omega)$ as the frequency dependent worst case gain (Leung et al., 1997). In the method, a weighting function is chosen to cover the gain of $\Phi(\delta s)$. Fig. 2 illustrates the block diagram of robust control method. Fig. 2 (a) shows a system with a single delay and it can be converted to Fig. 2 (b), i.e. $\Phi(\delta s) = \phi(\delta s) = e^{-\delta s} - 1$. Fig. 2 (c) represents multiplicative uncertainty with associated weighting function $W_d(s)$ and Δ_u is a unit disk ($\|\Delta_u\|_\infty = 1$).

$W_d(s)$ is chosen such that H_∞ gain of $W_d(s)$ is more than $\phi(\delta s) - 1$, i.e. $\|\phi(\delta s) - 1\|_\infty < \|W_d(s)\|_\infty$.

Fig. 3 shows the bode plot of $\phi(\delta s) = e^{-\delta s} - 1$, where (a) shows the plot of $\delta = 0.1$, (b) shows the plot of $\delta = 1$ and (c) shows the case of $\delta = 10$. As shown in the figures, the bode plot shifts along frequency axis by changing value of δ . It shifts towards the low frequency when δ becomes large.

The robust control method gives a sufficient condition based on the small gain theory by choosing a unit disk with a weighting function $W_d(s)$ for a set $\Delta(j\omega)$.

2.5 Conservation examination on LMI based method and robust control method

We examined conservativeness of LMI based conditions including Theorem 1, 2, 3 and previously introduced robust control based method.

2.5.1 Numerical example

Suppose a second order LTI system whose parameters are

$$A = \begin{bmatrix} 0 & 1 \\ -1 & -2\zeta \end{bmatrix}, \quad A_d = \begin{bmatrix} 0 & 0 \\ -1.1 & 0 \end{bmatrix} \tag{17}$$

where ζ corresponds to a damping factor.

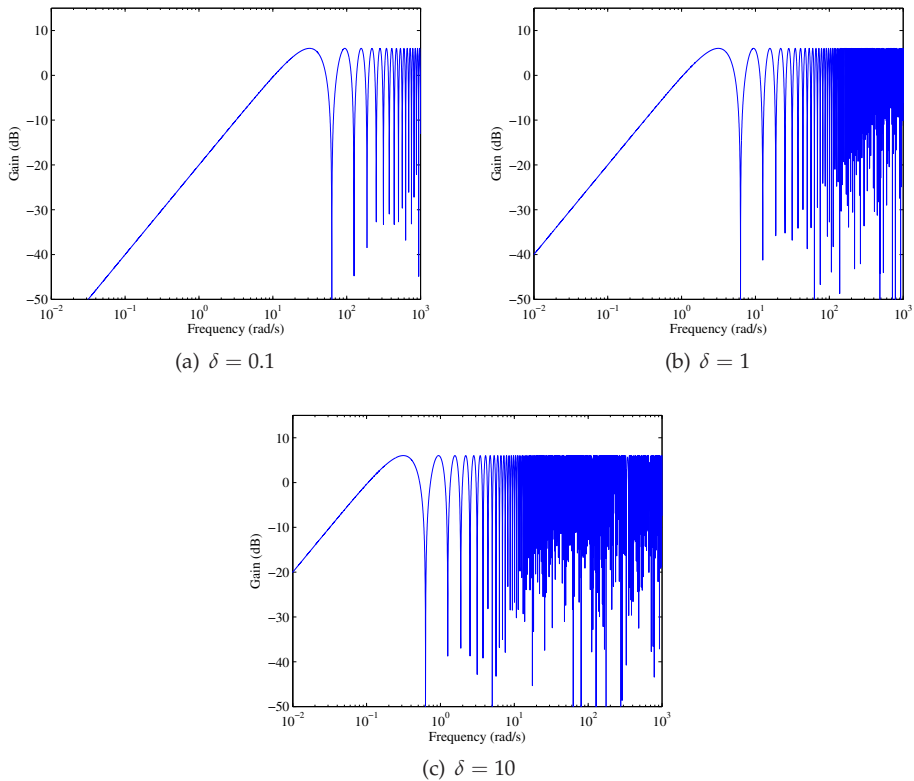

Fig. 3. Bode plot of $e^{-\delta s} - 1$

$\zeta \setminus$	Nyquist	Li'96	Park'99	Tang0	Tang1	Robust
0.1	0.1838	0.1818	0.1834	0.1834	0.1818	0.1809
0.3	0.6096	0.5455	0.5933	0.5933	0.5455	0.5289
0.5	1.2965	0.9091	1.1927	1.1927	0.9091	0.8690
0.7	2.9816	1.2727	2.4815	2.4815	1.2727	1.4210
1.0	7.9927	1.8182	6.0302	6.0302	1.8182	3.2000
10.0	117.0356	18.1818	85.0562	85.0562	18.1818	23.0000

Table 1. Upper bound of δ ($\bar{\delta}$)

By using YALMIP (Lofberg, 2005) with Matlab for the problem modeling and CSDP (CSDP, 1999) for the LMI solver, we calculated the maximum value of δ by solving LMI feasibility problem with iteration operations.

Table 1 shows the maximum value $\bar{\delta}$ which measures conservativeness of the conditions. In the table, Li'96 and Park'99 are obtained by the Theorem 1 and 2 respectively. Tang0 is the result when $\nu = 0$ and Tang1 is that of $\nu = 1$, where ν is in (13).

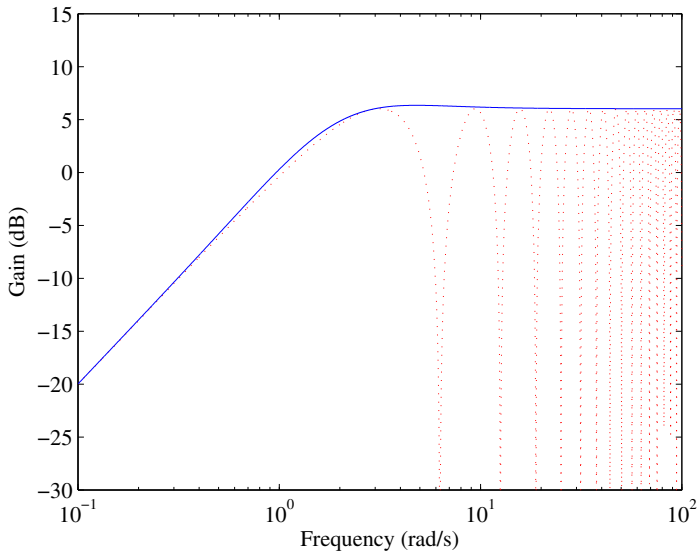

Fig. 4. Bode plots of $W_d(s)$ (blue line) and $e^{-Ts} - 1$ (red dotted line)

Robust in Table 1 shows the results of the robust control method which regards the varying delay as a perturbation, where the following weighting function was used.

$$W_d(s) = \frac{2s(T^2s^2/4 + (T + T/4)s + 1)}{(s + 2/T)(T^2s^2/4 + Ts + 1)} \tag{18}$$

Fig. 4 shows the bode plots of $W_d(s)$ and $e^{-Ts} - 1$ where $T = 1$. Notice that the results of Li'96 are exactly same as Tang1 and Park'99 are the same as Tang1. This implies these two pairs are equivalent conditions. In fact, $\nu = 0$ corresponds that time delay is constant because $\nu = \dot{\delta}(t)$. Robust control results lie between Tang0 and Tang1, i.e. between $\nu = 0$ and $\nu = 1$. In fact, the perturbation assumed by robust control shall include the case $\nu = 1$, thus these results imply that the robust control approach seems to be less conservative.

So far, Lyapunov-Krasovskii controllers are mostly designed with (memory less) static feedback of the plant state (Jiang & Han, 2005). From the performance point of view, the static state feedback performs often worse than the dynamic controller such as H_∞ based controllers.

2.5.2 Examination on LMI based method and μ -synthesis

Zhang also examined conservativeness on stability conditions formulated in LMI form and robust control (Zhang et al., 2001), both delay independent and dependent condition were also discussed. In the examination, a system in (2) with parameters in (19) and (20) was used, which was motivated by the dynamics of machining chatter (Tlustý, 1985).

$$A = \begin{bmatrix} 0 & 0 & 1 & 0 \\ 0 & 0 & 0 & 1 \\ -(10.0 + K) & 10.0 & 1 & 0 \\ 5.0 & -15.0 & 0 & -0.25 \end{bmatrix} \tag{19}$$

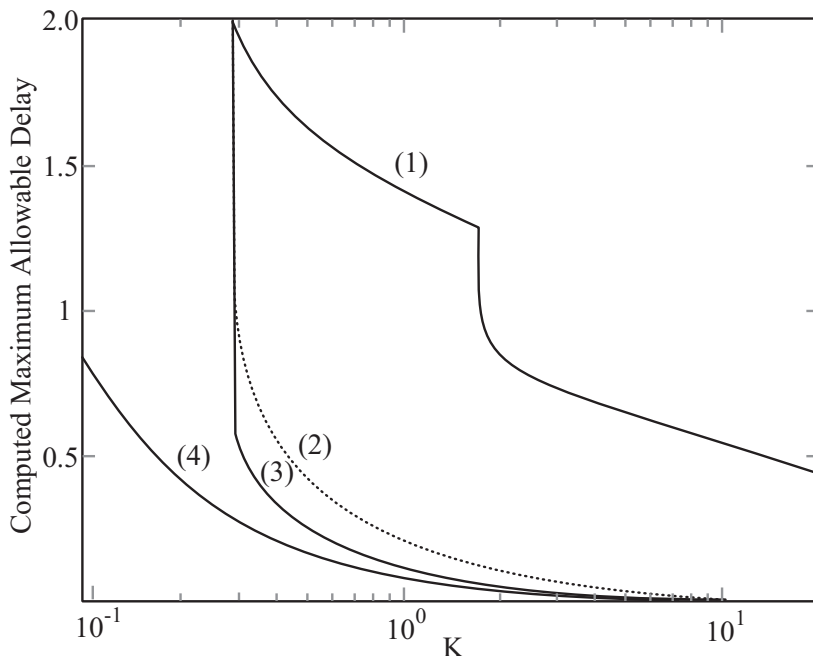

Fig. 5. Delay margin versus K.

$$A_d = \begin{bmatrix} 0 & 0 & 0 & 0 \\ 0 & 0 & 0 & 0 \\ K & 0 & 0 & 0 \\ 0 & 0 & 0 & 0 \end{bmatrix} \tag{20}$$

The paper examined conservativeness with μ -synthesis based method which is a representative method of the robust control. Specifically, it calculates the structured singular value $\mu_{\Delta_r}(G(j\omega))$ defined in (21) with respect to a block structure Δ_r in (22).

$$\mu_{\Delta_r}(G(j\omega)) = [\min\{\bar{\sigma}(\Delta) : \det(I - G\Delta) = 0, \Delta \in \Delta_r\}]^{-1} \tag{21}$$

$$\Delta_r := \{\text{diag}[\lambda_1 I_{n_1}, \lambda_2 I_{n_2}] : \lambda_i \in \mathbf{C}\}. \tag{22}$$

Because calculating of μ is NP-hard (non-deterministic polynomial-time hard), its upper bound with D scales defined in (23) and (24) was used.

$$\sup_{\omega \in \mathbf{R}} \inf_{D \in \mathbf{D}_r} \bar{\sigma}(DG(j\omega)D^{-1}) < 1 \tag{23}$$

$$\mathbf{D}_r := \{\text{diag}[D_1, D_2] | D_i \in \mathbf{C}^{n \times n}, D_i = D_i^* > 0\} \tag{24}$$

The analytical results are shown in Fig. 5 (Zhang et al., 2001). In the figure, the plot (1) shows the case of Nyquist Criterion, (2) shows μ upper bound with frequency-dependent D scaling, (3) shows the upper bound by Theorem 2 and (3) shows the upper bound by Theorem 1. The results show that the LMI based conditions are more conservative than D -scaled μ based method. The reason of this is stated that the scale matrix D in μ method is frequency

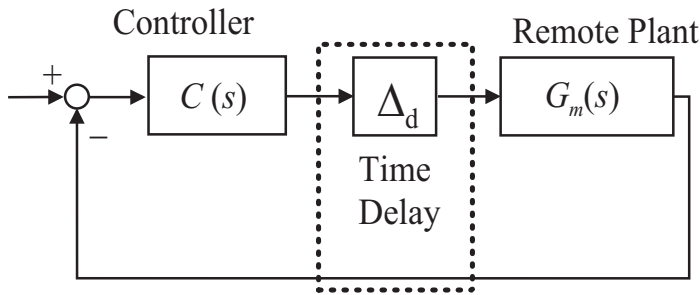

Fig. 6. Basic structure of network based system

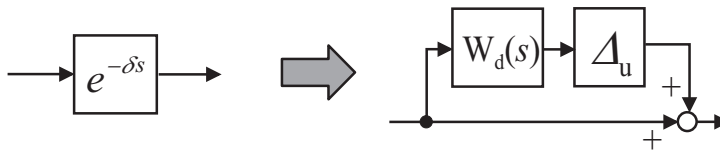

Fig. 7. Time varying delay as a perturbation

dependent function which is obtained by frequency sweeping of $G(j\omega)$. On contrary, LMI formed condition corresponds to fix D scale a real constant value. Constant D scaling is well known to provide a more conservative result than frequency-dependent D scaling. This result revealed that Lyapunov-Krasovskii based conditions formulated in LMI may be caught into conservative issue and their robust margin possibly becomes smaller than μ based controller. Through the investigations stated above, we determined to exploit a μ -synthesis based controller design. Because μ -synthesis based controller is designed based on the robust control theory. In the next section, we describe a model based μ controller design for a system with time delay and model uncertainty.

3. Model based μ -synthesis controller

Fig. 6 shows basic structure of a network based system where $C(s)$ is a controller and $G_m(s)$ is a remote plant. The block Δ_d is a delay factor which represents transmission delay on a network. It represents round trip delay, which accumulates forward and backward delays. The time varying delay $\delta(t)$ is bounded with $0 \leq \delta(t) \leq \bar{\delta}$. If the time delay $\delta(t)$ is a constant value δ_c , the block can be written as $\Delta_d = e^{-\delta_c s}$ in frequency domain, however $e^{-\delta s}$ is not accurate expression for time varying delay δ . As described in the previous section, Leung proposed to regard time varying delay as an uncertainty and the delay is represented as a perturbation associated with a weighting function (Leung et al., 1997). In particular, time delay factor can be denoted as shown in Fig. 7, where Δ_u is unknown but assure to be stable with $\|\Delta_u(s)\|_\infty \leq 1$ and $W_d(s)$ is a weighting function which holds $|e^{-\delta s} - 1| < |W_d(j\omega)|, \forall \omega \in \mathbf{R}$, i.e. $W_d(s)$ covers the upper bound of gain $e^{-\delta s} - 1$. Applying the small gain theory considering $\|W_d(s)\Delta_u(s)\|_\infty \leq \|W_d(s)\|_\infty$, the system is stable if the condition (25) holds.

$$\|C(s)G_m(s)(1 + W_d(s))\|_\infty < 1 \tag{25}$$

(25) is rewritten in (26)

$$\|C(s)\|_\infty < \frac{1}{\|G_m(s)(1 + W_d(s))\|_\infty} \tag{26}$$

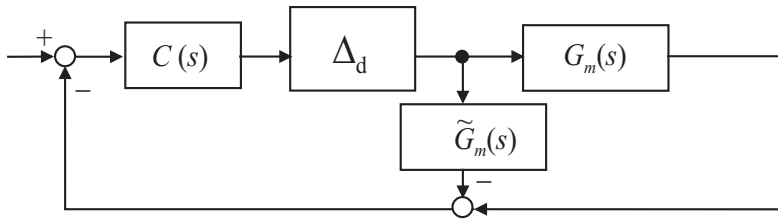

Fig. 8. Model based control structure

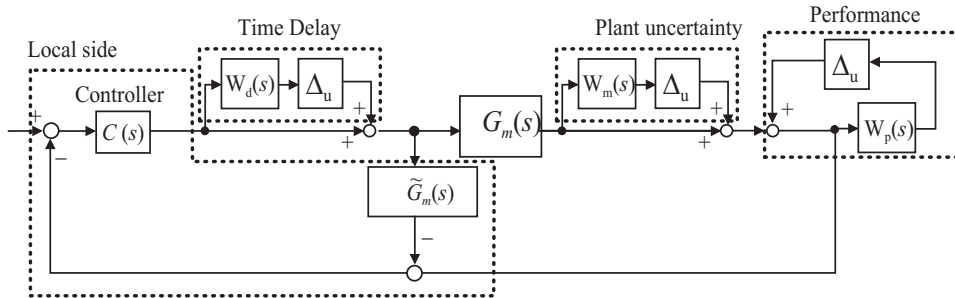

Fig. 9. Overall structure with perturbations

(26) implies the maximum gain of $C(s)$ is limited by the norm of $G_m(s)$ and $(1 + W_d(s))$. If the gain of $C(s)$ is small, even the norm sensitivity function without delay cannot become small as shown in (27).

$$\|S(s)\|_\infty = \left\| \frac{1}{1 + C(s)G_m(s)} \right\|_\infty \tag{27}$$

In general, the norm of the sensitivity function directly represents the performance of the system such as servo response and disturbance attenuation. The restriction due to the bounded norm of the controller may degrade the performance of the system. In order to avoid it, we propose a unification of model based control with μ -synthesis robust control design.

Fig. 8 shows a proposed model based control structure which includes the model of time delay and the remote plant where $\tilde{G}_m(s)$ is a model of the plant. In the real implementation, a model of time delay is also employed, which exactly measures the value of time delay. The measurement of delay can be implemented by time-stamped packets and synchronization of the local and remote node (Uchimura et al., 2007). By introducing the plant model, the upper bound restriction of $C(s)$ is relaxed if the model $\tilde{G}_m(s)$ is close to $G_m(s)$, i.e. if $\|\tilde{G}_m(s) - G_m(s)\|_\infty$ is smaller than $\|G_m(s)\|_\infty$.

$$\|C(s)\|_\infty < \frac{1}{\|(G_m(s) - \tilde{G}_m(s))(1 + W_d(s))\|_\infty} \tag{28}$$

In fact, perfect modeling of $G_m(s)$ is impossible and property of the remote model may vary in time due to various factors such as aging or variation of loads. Therefore we need to admit the difference between $\tilde{G}_m(s)$ and $G_m(s)$ and need to deal with it as a perturbation of the remote plant $G_m(s)$. Then another perturbation factor associated with a weighting function $W_m(s)$ is added. Additionally, another perturbation factor with $W_p(s)$ after the remote plant is also added to improve the performance of the system. $W_p^{-1}(s)$ works to restrict the upper bound

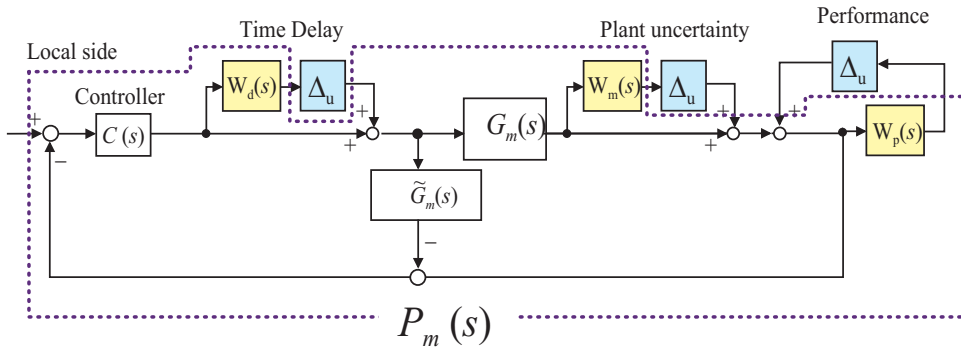

Fig. 10. Augmented plant P_m

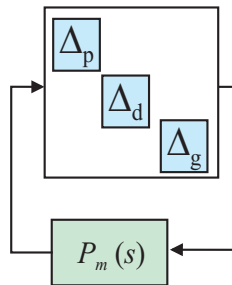

Fig. 11. Simplified block diagram of the augmented plant $P_m(s)$

of the norm of the sensitivity function $S(s)$. In the experiment described in later, the gain of $W_p(s)$ is large at low frequency range.

Fig. 9 shows the overall structure with perturbations of the proposed control system. There are three perturbations in the system and each perturbation has no correlation with others. Therefore we applied μ -synthesis to design the controller $C(s)$. As previously mentioned, the value of μ is hard to calculate thus we also employed frequency dependent scale $D(j\omega)$ to calculate the upper bound of μ_{D_r} as follows.

$$\mu_{D_r} = \sup_{\omega \in \mathbf{R}} \inf_{D \in D_r} \bar{\sigma} \left(D(j\omega) P_m(j\omega) D(j\omega)^{-1} \right) \tag{29}$$

Since there exist three perturbations in the proposed method, class of D_r is defined in (30).

$$D_r := \{ \text{diag}[d_1, d_2, d_3] \mid d_i \in \mathbf{C} \} \tag{30}$$

$P_m(s)$ in (29) is the transfer function matrix of the augmented plant with three inputs and three outputs. The plant $P_m(s)$ includes three weighting functions $W_d(s), W_m(s), W_p(s)$ and controller $C(s)$. Fig. 10 shows the augmented plant $P_m(s)$ where the area surrounded by dotted line corresponds to $P_m(s)$ and it can be simplified to the block diagram shown in Fig. 11.

Because finding $D(s)$ and $C(s)$ simultaneously is difficult, so called D - K iteration is used to find a adequate combination of $D(s)$ and $C(s)$.

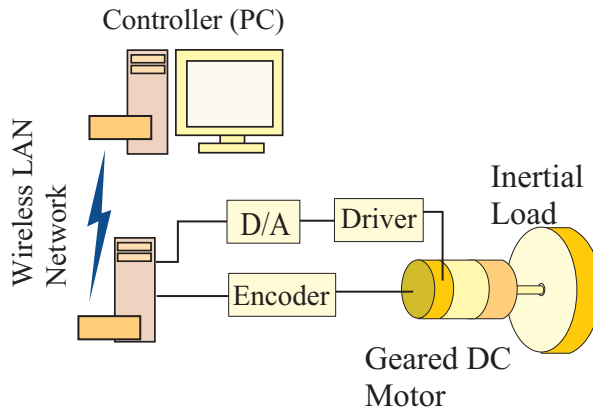

Fig. 12. Experimental setup and system configuration

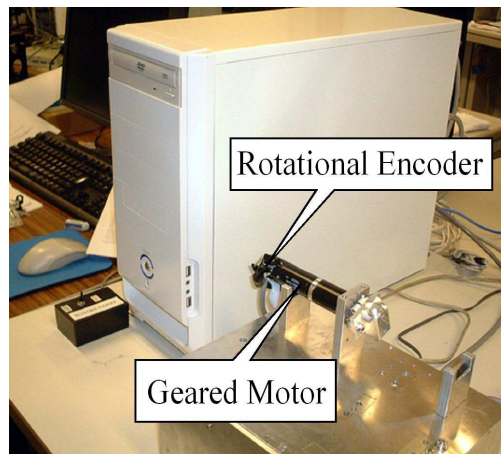

Fig. 13. Overview of the experimental device

4. Design of model based μ controller and experimental evaluation

4.1 Design procedure of a controller

In order to evaluate the performance of proposed controller, we set up an experiment. Fig. 12 shows the configuration of the experiment. As shown in the figure, we used wireless LAN to transmit data in between local controller and remote plant. Fig. 13 shows the overview of the experimental device of the remote plant (geared motor). In the experiment, we used a geared DC motor with an inertial load on the output axis. We assumed load variation, thus two different inertial loads are prepared. Through the examination of identification tests, the nominal plant $G_m(s)$ was identified as a first order transfer function in (31).

$$G_m(s) = \frac{260.36}{s + 154.28} \quad (31)$$

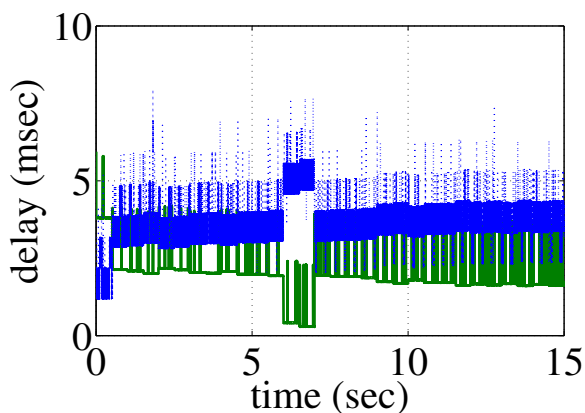

Fig. 14. Measurement results of time delay

We intentionally chose different transfer function for a plant model \tilde{G}_m in (32). It aimed to evaluate robust performance against unexpected load variations.

$$\tilde{G}_m(s) = \frac{182.25}{s + 108.0} \quad (32)$$

Fig. 14 shows one of the measurement results of time delay, green plot shows transmission delay from local to remote and the blue plot shows ones from remote to local. Based on measurements under various circumstances, we chose the upper bound of time delay as 100 [msec] and the weighing function W_d was chosen to be

$$W_d(s) = \frac{2.1s}{s + 10}. \quad (33)$$

The second weighting function $W_m(s)$ which is associated with model uncertainty was chosen to cover the difference of $G_m(s)$ and $\tilde{G}_m(s)$ as shown in (32).

$$W_m(s) = \frac{78s^2 + 12050s}{260s^2 + 92390s + 8056000} \quad (34)$$

The third weighting function $W_p(s)$ for performance is determined to maintain the value of the sensitivity function to be small. It also aimed to attenuate the disturbance at low frequency.

$$W_p(s) = \frac{0.421s + 4.21}{s + 0.01} \quad (35)$$

We used Robust Toolbox of Matlab for numerical computation including D - K iteration and obtained a solution of $C(s)$ which satisfied the condition $\mu_{\mathbf{D}_r} < 1$. After 8 times D - K iterations, peak μ value was converged to $\mu = 0.991$ and a controller with 17th order was obtained. The Bode plot of the obtained controller $C(s)$ is shown in Fig.15.

4.2 Experimental result

We implemented obtained controller on PC hardware by transferring it into the discrete-time controller with 1 [msec] sampling time. The controller tasks with motor control tasks

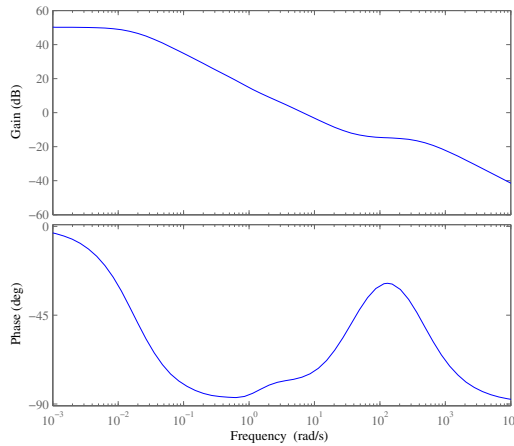

Fig. 15. Bode plot of the controller $C(s)$

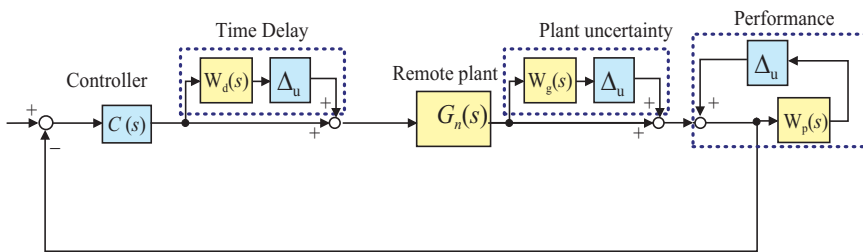

Fig. 16. Block diagram of the system with the conventional controller

were executed on RT-Linux. RT-Messenger (Sato & Yakoh, 2000) was used to implement the network data-transmission task in Linux kernel mode process. IEEE802.11g compliant wireless LAN device are used, which was connected to PC via USB bus. For the delay measurement, a beacon packet was used as a time stamp. A beacon packet contains a counter value of TSF (timing synchronization function), which is a standard function for IEEE 802.11 compliant devices and resolution of counter is 1 [μ sec]. The function synchronize both timers of local and remote node every 100 [msec] (Uchimura et al., 2007).

To evaluate the performance of the proposed controller, we prepared a controller for comparison purpose, which was also designed by μ -synthesis, however it is designed without the remote plant model $\tilde{G}_m(s)$ and the time delay model, hereinafter referred to as conventional controller. Fig. 16 shows the overall block diagram with the conventional controller. Comparing it with Fig. 9, one may notice that there is no plant model. The conventional controller corresponds to the one which appears in (Leung et al., 1997).

Fig. 17 shows the result of a step response of the velocity control. The blue plot shows the response of the proposed controller and the red plot shows the result by the conventional controller. Comparing these two plots, the proposed controller shows better response in transient response. Fig. 18 shows the result when we intentionally added 200 [msec] delay

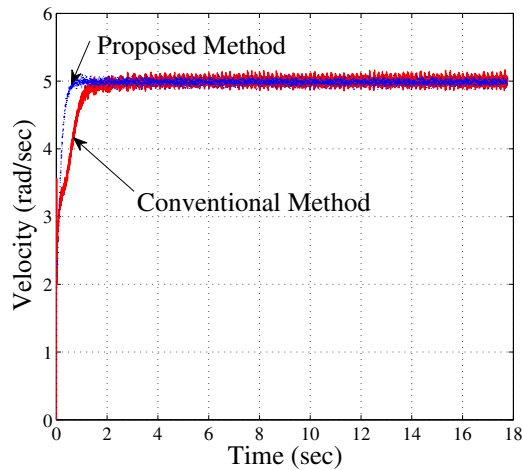

Fig. 17. Experimental results (Step response of velocity control)

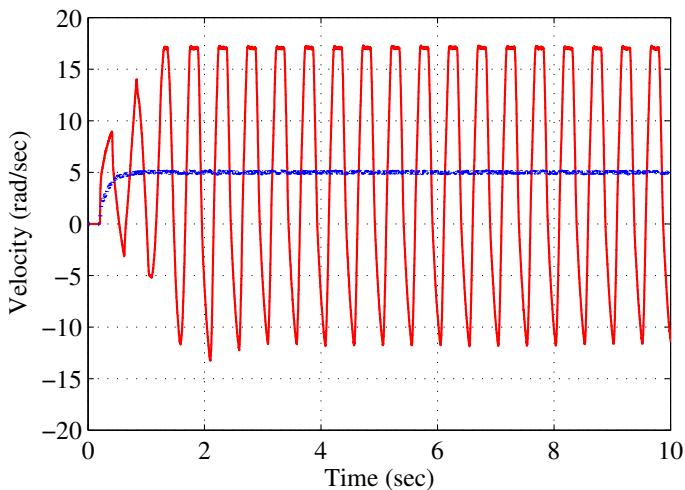

Fig. 18. Experimental results (with intentionally added delay)

in the network transmission path. The delay was virtually emulated by buffering data in memory.

Comparing two plots, the result by the conventional controller shows unstable response, whereas the response by the proposed controller still maintains stability. In fact, we designed both controllers under the assumption of 100 [msec] maximum delay, however the results showed different aspect. These results can be analyzed as following reasons. A μ -synthesis based controller guarantees to maintain robust performance of the system, namely it accomplishes required performance as long as the perturbations of delay and model uncertainty are within the worst case. In terms of robust performance, both proposed and

conventional controllers may show similar performance, because they are designed with same $W_p(s)$ for performance weight. In μ -synthesis based design, the obtained controller assures $\mu_{\Delta_r} < 1$ against all possible perturbations. However the system may be stable when one of the perturbations goes beyond the maximum, if it is not the critical one. Namely, the stability margins for different perturbations are not always same. As stated in previous section, model based controller holds more margin in loop gain; hence the deference in the delay margin may appear on the result. As a result, the proposed controller is more robust against time delay than the conventional controller while maintaining same performance.

5. Conclusion

In this chapter, a model based controller design by exploiting μ -synthesis is proposed, which is designed for a network based system with time varying delay and the plant model uncertainty. The proposed controller includes the model of the remote plant and time delay. The delay was measured by time-stamped packet. To avoid instability due to model uncertainty and variation of delays, we applied μ -synthesis based robust control method to design a controller. The paper also studied conservativeness on the stability condition based on Lyapunov-Krasovskii functional with LMI and on the robust control including μ -synthesis. Evaluation of the proposed system was carried out by experiments on a motor control system. From the results, we verified the stability and satisfactory performance of the system with the proposed methods.

6. References

- Anderson, R. J. & Spong, M. W. (1989). Bilateral Control of Teleoperators with Time Delay *IEEE Trans. on Automatic Control*, vol.34, no.5, pp. 494-501.
- Borchers, B. (1999). CSDP, A C library for semidefinite programming, *Optimization Methods and Software*, Volume 11, Issue 1 - 4 1999 , pp. 613 - 623.
- Chen, J. & Latchman, H. , (1994). Asymptotic stability independent of delays, *American Control Conference*, Vol. 1, pp. 1027 - 1031.
- Farsi, M.; Ratcliff, K. & Barbosa, M. (1999). An overview of Controller Area Network, *IEEE Computing and Control Engineering Journal*, Vol.10, pp. 113-120.
- Ghodoussi, M.; Butner, S.E. & Wang, Y. (2002). Robotic surgery - the transatlantic case, *Proc. of IEEE Int. Conf on Robotics and Automation*, pp.1882-1888, Vol. 2
- Huang, D. & Nguang, S. K. (2007). State feedback control of uncertain networked control systems with random time-delays, *46th IEEE Conf. on Decision and Control*, pp. 3964 - 3969.
- Jiang, X. & Han, Q. (2005). On H_∞ control for linear systems with interval time-varying delay, *Automatica*, vol.41, pp 2099 - 2106.
- Jun, M. & Safonov, M. G. (2000). Stability Analysis of a System with time delayed States, *IEEE American Control Conference*, pp. 949-952.
- Gu, K. ; Kharitonov, V. L. & Chen, J. (2003), *Stability of Time-Delay Systems*, 1st ed. Boston, MA: Birkhauser.
- Leung, G. ; Francis, B. ; Apkarian, J. (1997), Bilateral Controller for Teleoperators with Time Delay via μ -Synthesis, *IEEE Trans. on Robotics and Automation*, Vol. 11, No.1, pp. 105-116.
- Li, X. & de Souza, C. E. (1996). Robust stabilization and H_∞ control of uncertain linear timedelay systems, *Proc. 13th IFAC World Congress*, pp. 113-118.
- Lofberg, J. (2005). YALMIP : a toolbox for modeling and optimization in MATLAB 2004 *IEEE International Symposium on Computer Aided Control Systems Design*, , pp. 284 - 289.

- Mahmoud, M.S. & Al-bluthairi, N.F. (1994) Quadratic Stabilization of Continuous Time Systems with State delay and Norm-bounded Time-varying Uncertainties, *IEEE Trans. on Automatic Control*, pp. 2135-2139.
- Niculescu, S.-I. ; Neto, A. T. ; Dion, J.-M. & Dugard, L. (1995). Delay-dependent stability of linear systems with delayed state: An LMI approach, *Proc. 34th IEEE Conf. Decision Control*, pp. 1495-1497.
- Park, P. (1999). A delay-dependent stability criterion for systems with uncertain time-invariant delays, *IEEE Trans. Automat. Contr.*, vol. 44, pp.876-877.
- Palmor, Z. (1980), Stability properties of Smith dead-time compensator controllers, *Int. J. of Control*, Vol. 32, No. 6, pp. 937-949.
- Richard, J.P. (2003). Time-delay systems: an overview of some recent advances and open problems, *Automatica*, Volume 39, pp. 1667-1694.
- Sato, H. & Yakoh, T. (2000). A real-time communication mechanism for RTLinux, *26th Annual Conference of the IEEE Industrial Electronics Society, IECON 2000*, Vol.4, p.p 2437 - 2442.
- Skelton, R. E. ; Iwasaki, T. & Grigoriadis, K. (1998) A Unified Algebraic Approach to Linear Control Design, *New York: Taylor & Francis*.
- Smith, O. J. M. (1957). Closer Control of Loops with Dead Time , *Chemical Engineering Progress*, 53 , pp. 217 - 219.
- Tang, M. Liu, X. (2008). Delay-dependent stability analysis for time delay system, *7th World Congress on Intelligent Control and Automation*, pp. 7260 - 7263.
- Thusty, J. (1985). Machine dynamics, *Handbook of High Speed Machining Technology*, R. I. King, Ed. New York: Chapman & Hall, pp. 48 - 153.
- Uchimura, Y. ; Nasu, T. & Takahashi, M. (2007). Time synchronized wireless sensor network and its application to building vibration measurement, *Proc. of 33rd Annual Conference of the IEEE Industrial Electronics Society (IECON2007)*, pp. 2633 - 2638.
- Uchimura Y. & Yakoh T. , (2004). Bilateral robot system on the real-time network structure, *IEEE Trans. on Industrial Electronics*, Vol. 51, Issue: 5 , pp.940 - 946.
- Verriest, E. I. et.al. (1993). Frequency domain robust stability criteria for linear delay systems, *Proc. 32nd IEEE Conf. Decision Control*, pp. 3473-3478.
- Vatanski, N. ; Georges, J.P.; Aubrun, C. ; Rondeau, E. ; Jamsa-Jounela, S. (2009). Networked control with delay measurement and estimation, *Control Engineering Practice*, 17 (2) .
- Yue, D. , Han, Q.-L., Peng, C. (2004). State Feedback controller design for networked control systems, *IEEE Trans. Circ. Sys.*, vol. 51, no. 11, pp. 640-644.
- Yeh, S. ; Hsu, C. ; Shih, T. ; Hsiao, J. & Hsu, P. (2008). Remote control realization of distributed rescue robots via the wireless network, *Proc. of SICE Annual Conference*, pp.2928-2932.
- Yokokohji, Y. ; Imaida, T. & Yoshikawa, T. (1999). Bilateral teleoperation under time-varying communication delay, *IEEE/RSJ Int. Conf. Intelligent Robots and Systems*, Vol. 3, pp. 1854-1859.
- Zhang, J. ; Knopse, C.R. & Tsiotras, P. (2001). Stability of Time-Delay Systems: Equivalence between Lyapunov and Scaled Small-Gain Conditions, *IEEE Transactions on Automatic Control*, Vo. 46 , Issue: 3 , pp. 482 - 486.



Recent Advances in Robust Control - Novel Approaches and Design Methods

Edited by Dr. Andreas Mueller

ISBN 978-953-307-339-2

Hard cover, 462 pages

Publisher InTech

Published online 07, November, 2011

Published in print edition November, 2011

Robust control has been a topic of active research in the last three decades culminating in H_2/H_∞ and μ design methods followed by research on parametric robustness, initially motivated by Kharitonov's theorem, the extension to non-linear time delay systems, and other more recent methods. The two volumes of Recent Advances in Robust Control give a selective overview of recent theoretical developments and present selected application examples. The volumes comprise 39 contributions covering various theoretical aspects as well as different application areas. The first volume covers selected problems in the theory of robust control and its application to robotic and electromechanical systems. The second volume is dedicated to special topics in robust control and problem specific solutions. Recent Advances in Robust Control will be a valuable reference for those interested in the recent theoretical advances and for researchers working in the broad field of robotics and mechatronics.

How to reference

In order to correctly reference this scholarly work, feel free to copy and paste the following:

Yutaka Uchimura (2011). Model Based μ -Synthesis Controller Design for Time-Varying Delay System, Recent Advances in Robust Control - Novel Approaches and Design Methods, Dr. Andreas Mueller (Ed.), ISBN: 978-953-307-339-2, InTech, Available from: <http://www.intechopen.com/books/recent-advances-in-robust-control-novel-approaches-and-design-methods/model-based-synthesis-controller-design-for-time-varying-delay-system>

INTECH
open science | open minds

InTech Europe

University Campus STeP Ri
Slavka Krautzeka 83/A
51000 Rijeka, Croatia
Phone: +385 (51) 770 447
Fax: +385 (51) 686 166
www.intechopen.com

InTech China

Unit 405, Office Block, Hotel Equatorial Shanghai
No.65, Yan An Road (West), Shanghai, 200040, China
中国上海市延安西路65号上海国际贵都大饭店办公楼405单元
Phone: +86-21-62489820
Fax: +86-21-62489821

© 2011 The Author(s). Licensee IntechOpen. This is an open access article distributed under the terms of the [Creative Commons Attribution 3.0 License](#), which permits unrestricted use, distribution, and reproduction in any medium, provided the original work is properly cited.