

The Development of the Omnidirectional Mobile Home Care Robot

Jie-Tong Zou

*Department of Aeronautical Engineering, National Formosa University
Taiwan, R.O.C.*

1. Introduction

In the last few years, intelligent robots were successfully fielded in hospitals (King, S., and Weiman, C, 1990), museums (Burgard, W. et al., 1999), and office buildings/department stores (Endres, H. et al. , 1998), where they perform cleaning services, deliver, educate, or entertain (Schraft, R., and Schmierer, G. , 2005). Robots have also been developed for guiding blind people, as well as robotic aids for the elderly.

Today, the number of elderly in need of care is increasing dramatically. As the baby-boomer generation approaches the retirement age, this number will increase significantly. Current living conditions for the majority of elderly people are already unsatisfactory, and situation will worsen in the future. (Nicholas Roy et al. , 2000)

Rapid progress of standard of living and health care resulted in the increase of aging population. More and more elderly people do not receive good care from their family or caregivers. Maybe the intelligent service robots can assist people in their daily living activities. Robotics aids for the elderly have been developed, but many of these robotics aids are mechanical aids. (Song, W.-K. et al., 1998) (Dario, P. et al., 1999) (Takahashi, Y. et al., 1999). The intelligent service robot can assist elderly people with many tasks, such as remembering to take medicine or measure blood pressure on time.

The main objective of this Chapter is to develop an omnidirectional mobile home care robot. This service mobile robot is equipped with "Indoor positioning system". The indoor positioning system is used for rapid and precise positioning and guidance of the mobile robot. Five reflective infrared sensors are placed around the robot for obstacle avoidance.

The wireless IP camera is placed on the top layer of this robot. Through the internet remote control system, the live image of the IP camera on the robot can be transferred to the remote client user. With this internet remote control system, the remote client user can monitor the elderly people or the home security condition. On the aid of this system, remote family member can control the robot and talk to the elderly. This intelligent robot also can deliver the medicine or remind to measure the blood pressure or blood sugar on time. We hope this intelligent robot can be a housekeeper or family guard to protect our elderly people or our family.

The functions of the proposed robot are illustrated as follows:

- deliver medicine or food on time
- remind to measure and record the blood pressure or blood sugar of the elderly on time

- remind the elderly to do something important
- assist the elderly to stand or walk
- send a short message automatically under emergency condition
- With the remote control system, remote family member can control the robot and talk to the elderly.

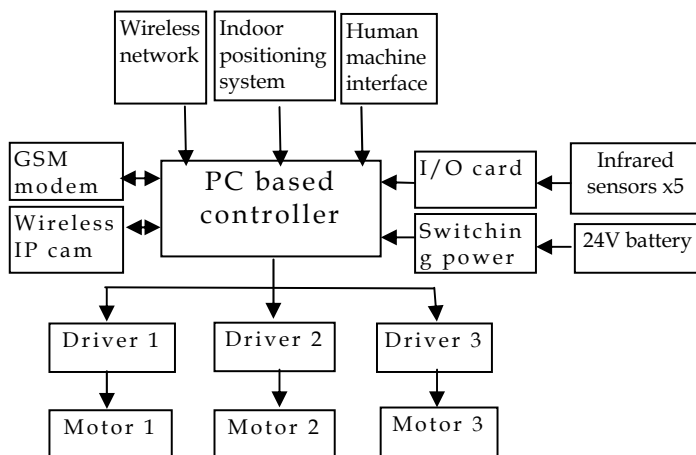

Fig. 1. Hardware structure of the omnidirectional mobile home care robot.

Hardware structure of the omnidirectional mobile home care robot is shown in Fig. 1. A PC based controller was used to control three DC servo motors. The indoor positioning system was used for rapid and precise positioning and guidance of the mobile robot. Five reflective infrared sensors are connected to an I/O card for sensor data acquisition. The GSM modem can send a short message automatically under emergency condition. The live image of the wireless IP camera on the robot can be transferred to the remote client user. The subsystems of this robot are explained in the following sections.

2. The robot mechanism

The proposed omnidirectional mobile home care robot is shown in Fig. 2 and Fig. 3. The main body of this robot is consisted with five layers of hexagonal aluminum alloy board. Many wheeled mobile robots are equipped with two differential driving wheels. Since these robots possess 2 degrees-of-freedom (DOFs), they can rotate about any point, but cannot perform holonomic motion including sideways motion (Jae-Bok Song and Kyung-Seok Byun , 2006). To increase the mobility of this service robot, three omni-directional wheels driven by three DC servo motors are assembled on the robot platform (see Fig. 4). The omnidirectional mobile robots can move in an arbitrary direction without changing the direction of the wheels.

The three-wheeled omni-directional mobile robots are capable of achieving 3 DOF motions by driving 3 independent actuators (Carlisle, B., 1983) (Pin, F. & Killough, S., 1999), but they may have stability problem due to the triangular contact area with the ground, especially when traveling on a ramp with the high center of gravity owing to the payload they carry.

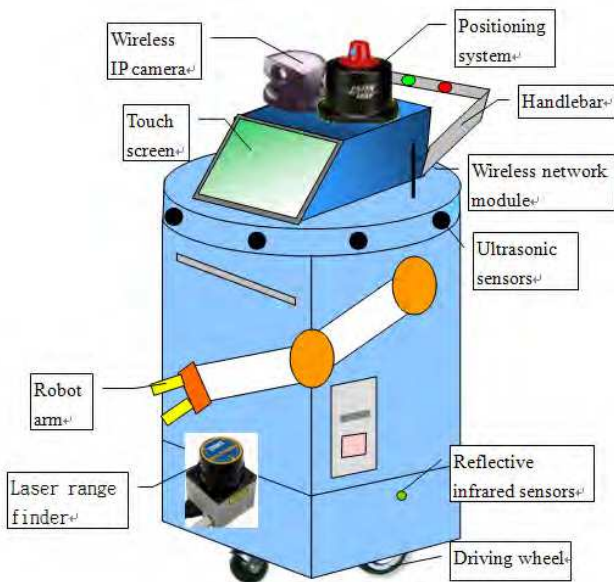

Fig. 2. Structure of the omnidirectional mobile home care robot.

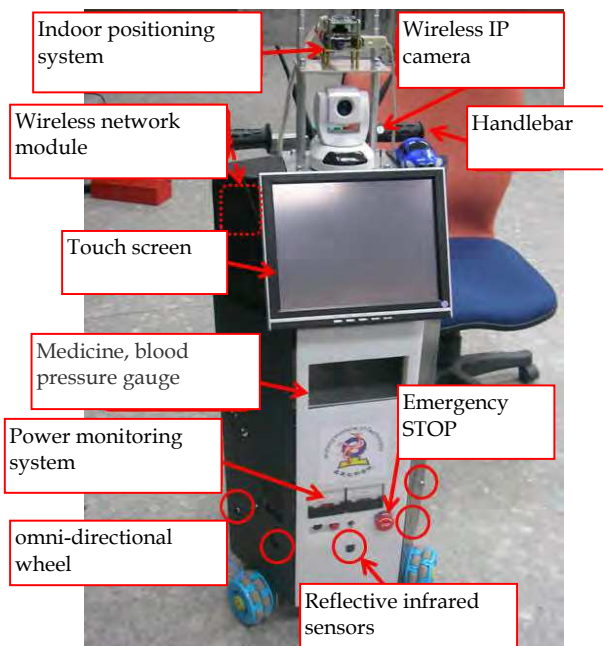

Fig. 3. Photo of the omnidirectional mobile home care robot.

Fig. 5(a) is structures of the omni-directional wheel, Fig. 5(b) is the motor layout of the robot platform. The relationship of motor speed and robot moving speed is shown as:

$$\begin{aligned}
 V_1 &= \omega_1 r = V_x + \omega_p R \\
 V_2 &= \omega_2 r = -0.5V_x + 0.867V_y + \omega_p R \\
 V_3 &= \omega_3 r = -0.5V_x - 0.867V_y + \omega_p R
 \end{aligned}
 \tag{1}$$

Where:

- V_i =Velocity of wheel i
- ω_i =rotation speed of motor i
- ω_p = rotation speed of robot
- r =radius of wheel
- R =distance from wheel to center of the platform

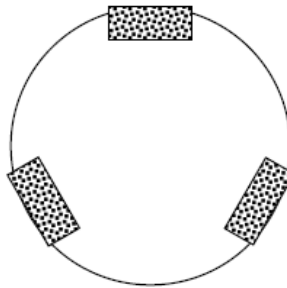

Fig. 4. Robot platform with three Omnidirectional wheels.

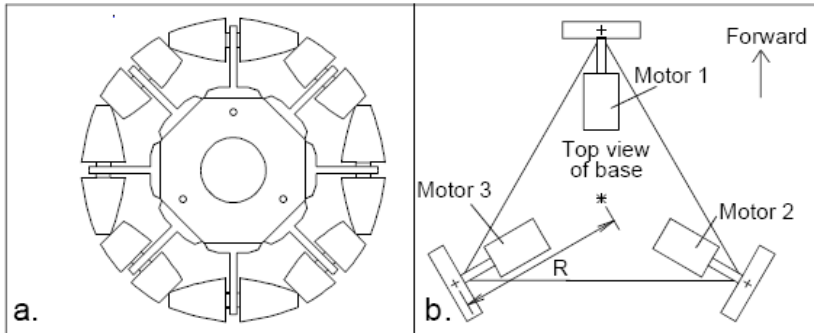

Fig. 5. (a) Structure of Omni-directional wheel; (b)Motor layout of Robot platform

As shown in Fig. 6, 3D CAD software (SolidWork) was used to design the robot platform. In Fig. 7, an omni-directional wheel composed of passive rollers or balls was driven by a DC servo motor. Fig. 8 is the photo of the robot platform with three omni-directional wheels. The omni-directional robot platform can move in an arbitrary direction and can rotate about any point. The omni-directional robot platform can enhance the mobility of mobile robots.

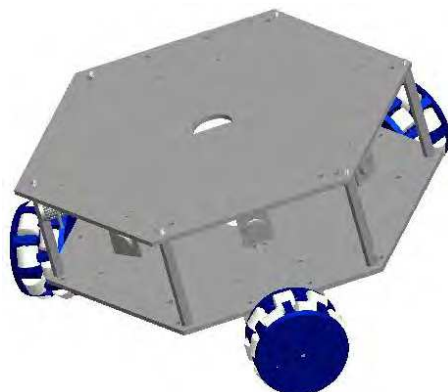

Fig. 6. 3D CAD software was used to design the robot platform



Fig. 7. An omni-directional wheel was driven by DC servo motor

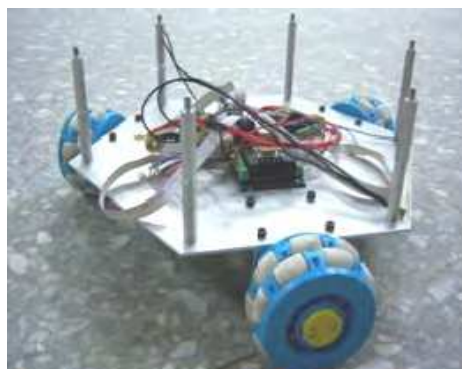

Fig. 8. Photo of the robot platform with three omni-directional wheels

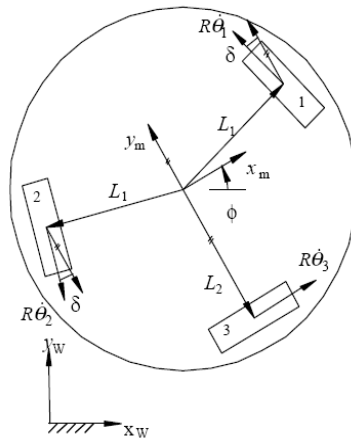

Fig. 9. Kinematic Diagram of the robot platform with three omni-directional wheels

Fig. 9 is the kinematic diagram of the robot platform with three omni-directional wheels. The inverse kinematic equations of the robot platform with three omni-directional wheels are shown as follow:

$$\begin{aligned}
 R\dot{\theta}_1 &= -\sin(\delta + \phi)\dot{x}_w + \cos(\delta + \phi)\dot{y}_w + L_1\dot{\phi} \\
 R\dot{\theta}_2 &= -\sin(\delta - \phi)\dot{x}_w - \cos(\delta - \phi)\dot{y}_w + L_1\dot{\phi} \\
 R\dot{\theta}_3 &= \cos(\phi)\dot{x}_w + \sin(\phi)\dot{y}_w + L_2\dot{\phi}
 \end{aligned}
 \tag{2}$$

Where:

- L_i =distance from center of the platform to omni-directional wheel
- ψ =Orientation angle according to world coordinate $[x_w, y_w]$
- θ_i =rotation angle of omni-directional wheel i

The inverse Jacobian matrix can be derived from the above equations:

$$\begin{bmatrix} \dot{\theta}_1 \\ \dot{\theta}_2 \\ \dot{\theta}_3 \end{bmatrix} = \frac{1}{R} \begin{bmatrix} -\sin(\delta + \phi) & \cos(\delta + \phi) & L_1 \\ -\sin(\delta - \phi) & -\cos(\delta - \phi) & L_1 \\ \cos(\phi) & \sin(\phi) & L_2 \end{bmatrix} \begin{bmatrix} \dot{x}_w \\ \dot{y}_w \\ \dot{\phi} \end{bmatrix}
 \tag{3}$$

3. Indoor localization system

As shown in Fig. 10, Indoor localization system (<http://www.hagisonic.com/>), which used IR passive landmark technology, was used in the proposed service mobile robot. The localization sensor module (see Fig. 11) can analyze infrared ray image reflected from a passive landmark (see Fig. 12) with characteristic ID. The output of position and heading angle of a mobile robot is given with very precise resolution and high speed. The position repetition accuracy is less than 2cm; the heading angle accuracy is 1 degree.

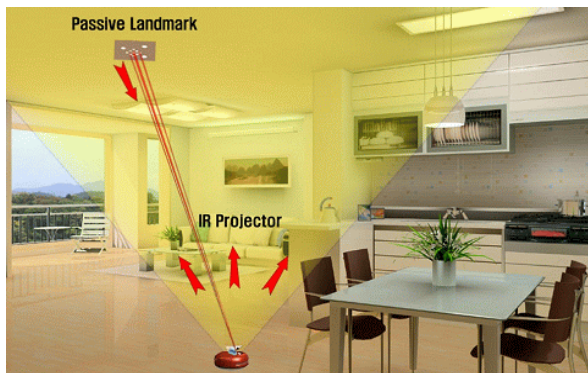

Fig. 10. Indoor localization system (Hagisonic co.)



Fig. 11. Localization sensor module (Hagisonic co.)

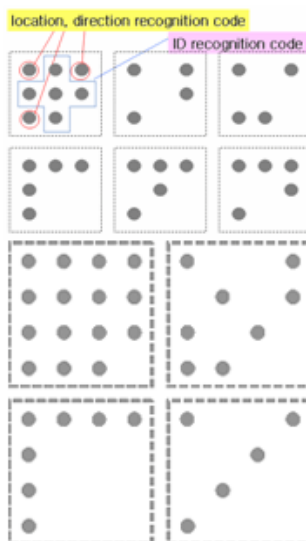

Fig. 12. IR passive landmark (Hagisonic co.)

4. Robot control system

As shown in Fig. 13, a PC based controller was used to control the mobile robot. Through RS232 interface, PC based controller can control three motor drivers to drive three DC servo motors. The PC based controller and Solid State Disks (SSD) are shown in Fig. 14. Solid State Disks have no moving parts. Consequently, SSDs deliver a level of reliability in data storage that hard drives cannot approach. In this mobile robot application that is exposed to shock or vibration, the reliability offered by SSDs is vitally important.

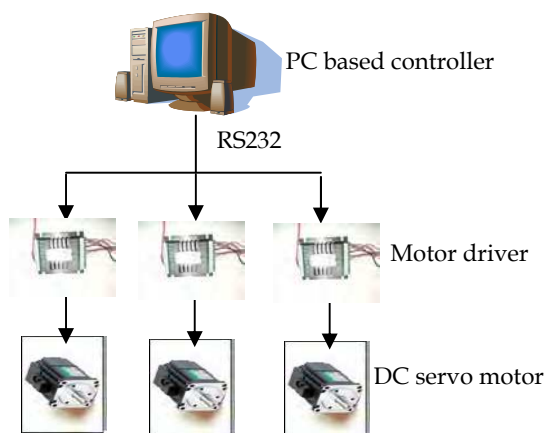

Fig. 13. PC based controller and motor drivers.



Fig. 14. PC based controller and Solid State Disk (SSD)

5. Obstacle avoidance system

Obstacle avoidance is a robotic discipline with the objective of moving vehicles on the basis of the sensorial information. As shown in Fig. 15, five reflective infrared sensors (see Fig. 16) are placed around the robot for obstacle avoidance. Five infrared sensors are numbered from 1 to 5 in a counterclockwise direction. If the obstacle is in front of the robot or on the left hand side, it will turn right. If the obstacle is on the right hand side, it will turn left.

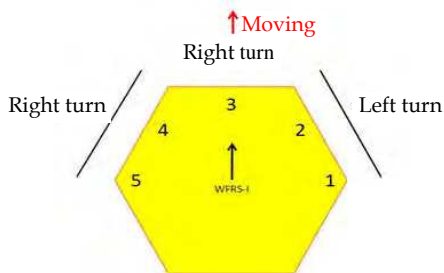

Fig. 15. Five reflective infrared sensors are placed around the robot on the bottom layer



Fig. 16. Five reflective infrared sensors

6. Human-machine interface (HMI)

The human-machine interface (HMI) includes touch screen, speaker, and appliances voice control system. Touch screen can be regarded as input and display interface. Speaker can

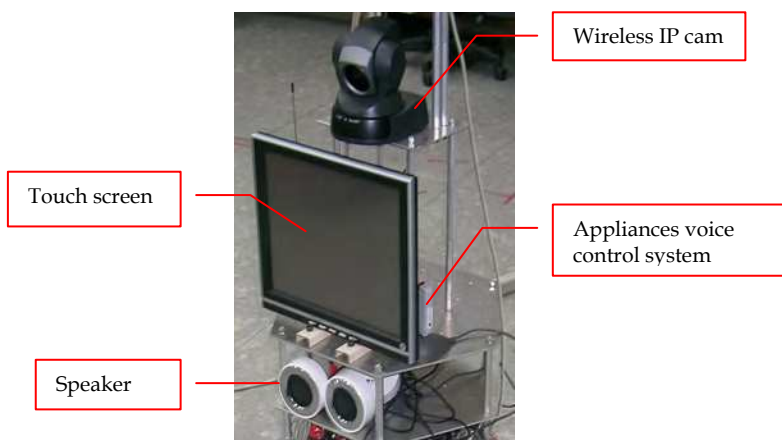

Fig. 17. Human-machine interface (HMI)

produce the voice of robot. Appliances voice control system can let users or the elderly to remote control the appliances by voice command.

7. Software interface

The software interface of the proposed robot is developed by Visual BASIC program. As shown in Fig. 18, the main interface of the proposed service robot can be divided into the following six regions:

1. **Home map region:** The home map and the targets position are displayed in this region. With the information from the indoor positioning system, the position and heading angle of the mobile robot also can be shown in this region.
2. **Robot targets setting region:** First, as a teaching stage, a user controls a robot by joystick or other interface and teaches the targets to the robot. The position and heading angle of the mobile robot on the target place can be recorded into a file. Next, as a playback stage, the robot runs autonomously on the path instructed during the teaching stage.
3. **Positioning system information region:** With the aid of the indoor positioning system, the mobile robot position (X,Y) and heading angle also can be shown in this region.
4. **Infrared sensors information:** Five reflective infrared sensors are placed around the robot for obstacle avoidance. Five reflective infrared sensors are connected to an I/O card for sensor data acquisition. Obstacles in front of the mobile robot can be displayed in this region.
5. **Robot control interface:** In this region, users can control the mobile robot to move in an arbitrary direction or rotate about any point
6. **Remote control information:** With the internet remote control system, the remote client user can monitor the elderly people or the home security condition. On the aid of this system, remote family member can control the robot and talk to the elderly. The remote user IP and the remote control command also can be shown in this region.

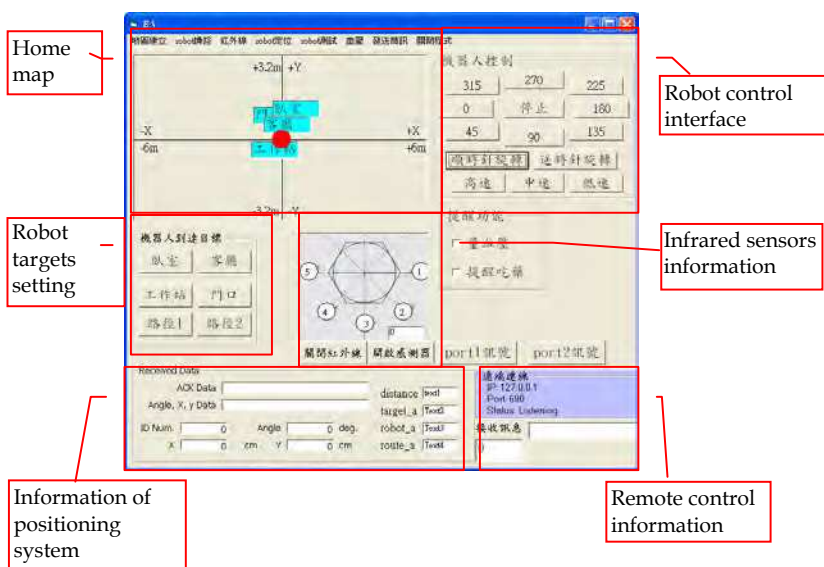

Fig. 18. Main interface of the proposed robot

The proposed service robot can remind the elderly to measure and record the blood pressure or blood sugar on time. As shown in Fig. 19, the blood pressure or blood sugar data can be displayed and recorded in this interface. If blood pressure or blood sugar data is too high, the GSM modem will send a short message automatically to the remote families.

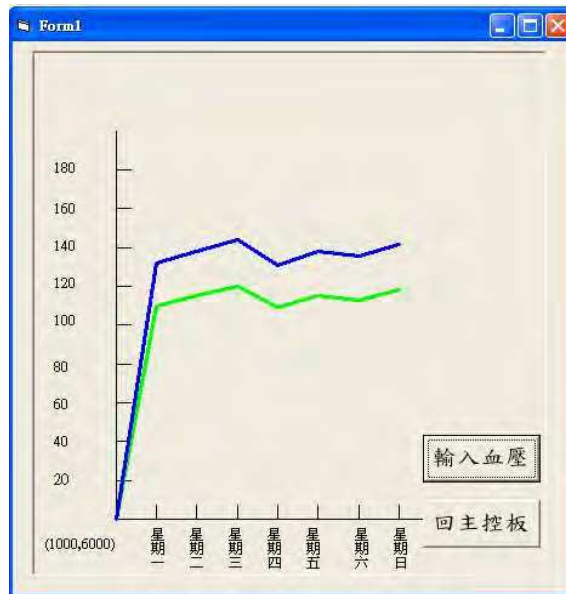

Fig. 19. Interface for blood pressure measurement

8. Experimental results

In order to understand the stability of three wheeled omni-directional mobile robot, an experiment for the straight line path error had been discussed (Jie-Tong Zou, et al., 2010). From these experimental results, when the robot moves faster or farther, the straight line error will increase. We make some experiments to measure several different paths error of the proposed mobile robot in this research.

8.1 Rectangular path error test for the omni-directional robot platform

In this experiment, the proposed mobile robot will move along a rectangular path with or without the guidance of the indoor localization system. As shown in Fig. 20, the mobile robot moves along a rectangular path (a→b→c→d→a) without the guidance of the localization system. The localization system is only used to record the real path in this experiment.

In Fig. 20, solid line represents the ideal rectangular path, dot lines (■:Test1, ▲:Test2) are the real paths of the mobile robot without the guidance of the localization system. The vertical paths (path b→c and d→a) have larger path error. Finally, the mobile robot cannot return to the starting point "a".

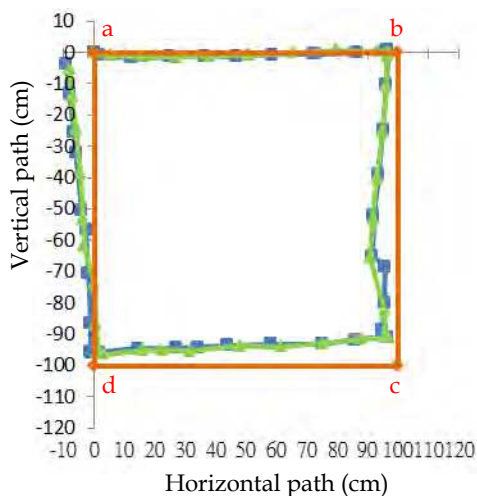

Fig. 20. Rectangular path error without the guidance of the localization system.

As shown in Fig. 21, the mobile robot moves along a rectangular path (a→b→c→d→a) with the guidance of the localization system. In Fig. 21, solid line represents the ideal rectangular path, dot lines (■:Test1, ▲:Test2) are the real paths of the mobile robot with the guidance of the localization system. With the guidance of the localization system, the mobile robot can pass through the corner points a, b, c, d. The rectangular path error in Fig.21 is smaller than that in Fig. 20. The maximum path error is under 10 cm in Fig.21. Finally, the mobile robot can return to the starting point "a". The rectangular path is closed at point "a".

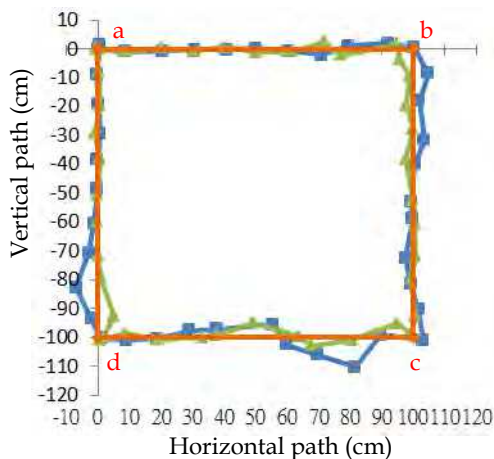

Fig. 21. Rectangular path error with the guidance of the localization system.

8.2 Circular path error test for the omni-directional robot platform

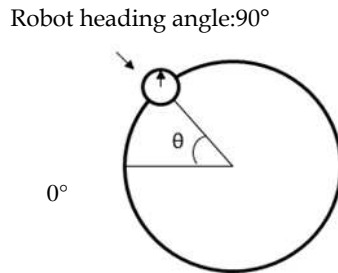

Fig. 22. Circular angle (θ) of the robot

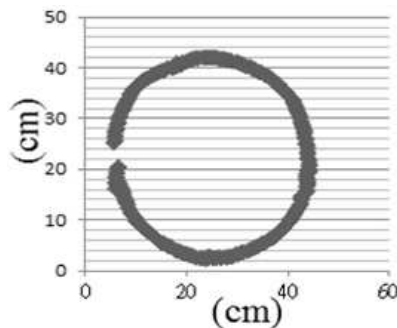

Fig. 23. Circular path without the guidance of the localization system.

The omni-directional mobile robot can move in an arbitrary direction without changing the direction of the wheels. In this experiment, the proposed mobile robot will move along a circular path with or without the guidance of the indoor localization system. As shown in Fig. 22, the mobile robot moves along a circular path without the guidance of the localization system. The robot heading angle is 90° (upwards) during this test. The localization system is only used to record the real path in this experiment.

The circular path without the guidance of the localization system is shown in Fig. 23. The shape of the real path is similar to a circle, but the starting point and the end point cannot overlap. The heading angle error with different circular angle (θ) of the robot is shown in Fig. 24. The maximum heading angle error is about 8° .

The circular path with the guidance of the localization system is shown in Fig. 25. The shape of this path is more similar to a circle; the starting point and the end point are overlapped. The heading angle error with different circular angle (θ) of the robot is shown in Fig. 26. The maximum heading angle error is about $\pm 1^\circ$. From this experiment result, the localization system can successfully maintain the robot heading angle along a circular path.

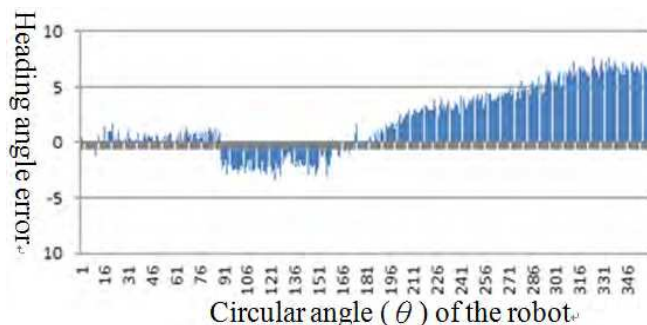

Fig. 24. Heading angle error with different circular angle (θ) of the robot

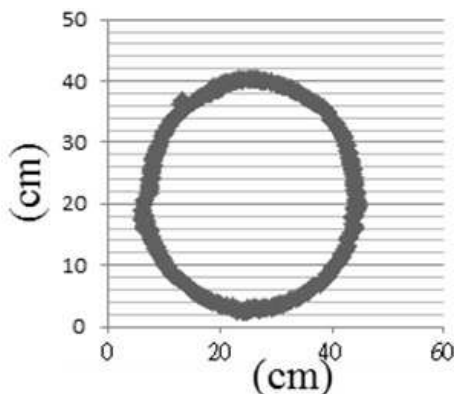

Fig. 25. Circular path with the guidance of the localization system.

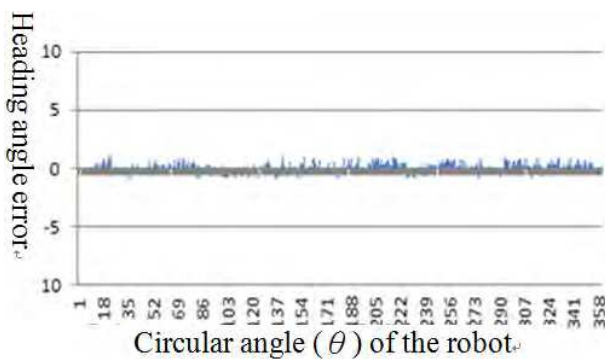

Fig. 26. Heading angle error with different circular angle (θ) of the robot

8.3 Functions test for robot taking care of the elderly

8.3.1 Delivering medicine or food on time

The elderly people usually forget to take medicine or measure blood pressure on time. It is harmful for the elderly people's health. The proposed robot can deliver medicine or food on the preset time. The robot also can remind the elderly to take medicine on time.

8.3.2 Assist the elderly to stand or walk

As shown in Fig. 27, a handlebar is placed on the rear side of the robot. With the assistance of the robot, the elderly can hold the handlebar to stand up or walk. The elderly can set the target place on the touch screen and hold on the handle bar, the mobile robot will help the elderly to the target place. There are four buttons (Start, Stop, Speed up, Slow down) on the handlebar, the elderly can control the robot speed to fit his walk speed.

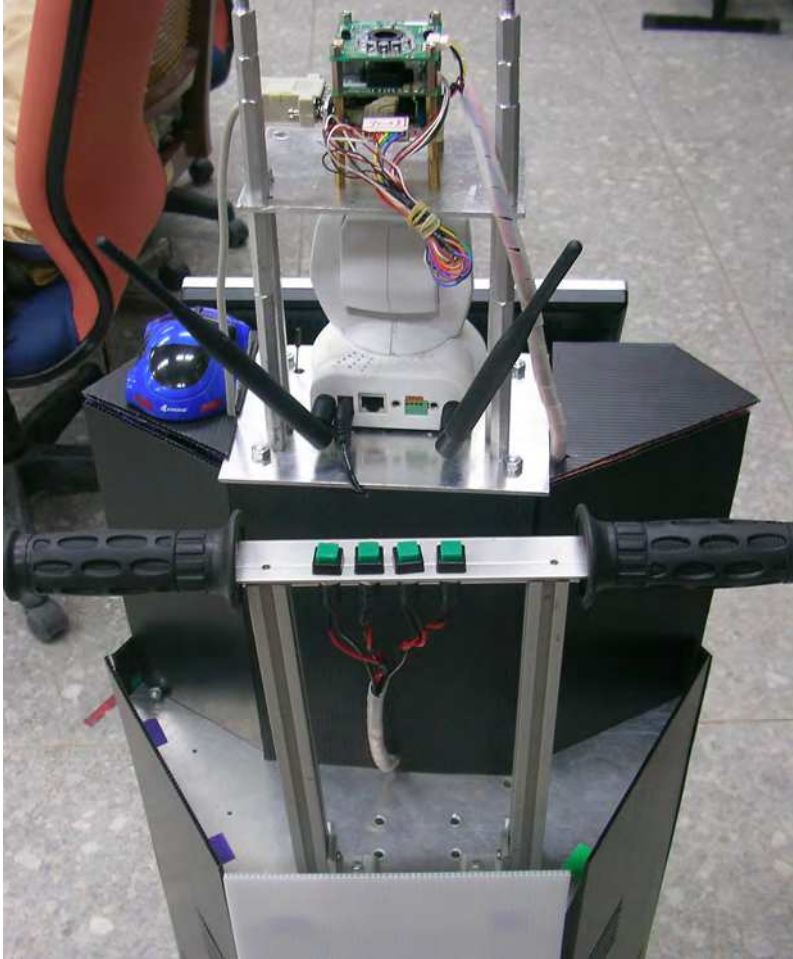

Fig. 27. Robot can assist the elderly to stand or walk

8.3.3 Send a short message automatically under emergency condition

The blood pressure measurement and short message sending interface is shown in Fig. 28. The robot will remind the elderly to take blood pressure or blood sugar on time. When the elderly finished taking blood pressure (the blood pressure gauge is shown in Fig. 29), the blood pressure data will be recorded in the robot's computer. If the blood pressure is too

high, the robot will send a short message to the remote families automatically. If the elderly has emergency condition, for example, the elderly falls down, he can press the “Emergency” button, the robot also can send a short message to the families to deal with this emergency condition.

Fig. 28. Blood pressure measurement and short message sending interface



Fig. 29. Blood pressure gauge

8.3.4 Remote control system

The wireless IP camera is placed on the top layer of this robot. Through the internet remote control system, the live image of the IP camera on the robot can be transferred to the remote client user. With this internet remote control system, the remote client user can monitor the elderly people or the home security condition. On the aid of this system, remote family member can control the robot and talk to the elderly.



Fig. 30. Remote control interface

9. Conclusion

Today, the number of elderly in need of care is increasing dramatically. More and more elderly people do not receive good care from their family or caregivers. Maybe the intelligent service robots can assist people in their daily living activities.

The main objective of this Chapter is to present an omnidirectional mobile home care robot. This service mobile robot is equipped with "Indoor positioning system". The indoor positioning system is used for rapid and precise positioning and guidance of the mobile robot. Five reflective infrared sensors are placed around the robot for obstacle avoidance.

In order to present the stability of three wheeled omni-directional mobile robot, the authors make some experiments to measure the rectangular and circular path error of the proposed mobile robot in this research.

Firstly, the mobile robot moves along a rectangular path without the guidance of the localization system. The experimental paths have larger path error. Finally, the mobile robot cannot return to the starting point. To overcome this problem, the indoor localization system was used to compensate the path error. With the guidance of the localization system, the maximum path error is under 10 cm. Finally, the mobile robot can pass through the corner points and return to the starting point. The rectangular path is closed at the starting point.

Secondly, the proposed mobile robot can move along a circular path with or without the guidance of the indoor localization system. The circular path without the guidance of the localization system cannot be closed. The maximum heading angle error is about 8°.

The circular path with the guidance of the localization system is more similar to a circle; the starting point and the end point are overlapped. The maximum heading angle error is about $\pm 1^\circ$. From this experiment result, the localization system can successfully maintain the robot heading angle along a circular path.

On the aid of the remote control system, remote family member can control the robot and talk to the elderly. This intelligent robot also can deliver the medicine or remind to measure the blood pressure or blood sugar on time. We hope this intelligent robot can be a housekeeper or family guard to protect our elderly people or our family.

10. References

- King, S., and Weiman, C (1990), "Helpmate autonomous mobile robot navigation system", Proceedings of the SPIE Conference on Mobile Robots, Vol. 2352, pp.190–198.
- Burgard, W.; Cremers, A.; Fox, D.; Hahnel, D.; Lakemeyer, G.; Schulz, D.; Steiner, W.; and Thrun, S. (1999), "Experiences with an interactive museum tour-guide robot", Artificial Intelligence.
- Endres, H.; Feiten, W.; and Lawitzky, G. (1998), "Field test of a navigation system: Autonomous cleaning in supermarkets.", Proceedings of the 1998 IEEE International Conference on Robotics & Automation (ICRA 98).
- Schraft, R., and Schmierer, G. (1998), "Serviceroboter", Springer verlag. In German.
- Nicholas Roy, Gregory Baltus, Dieter Fox, Francine Gemperle, Jennifer Goetz, Tad Hirsch, Dimitris Margaritis, Michael Montemerlo, Joelle Pineau, Jamie Schulte, Sebastian Thrun (2000), "Towards Personal Service Robots for the Elderly", Workshop on Interactive Robots and Entertainment (WIRE 2000).
- Song, W.-K.; Lee, H.-Y.; Kim, J.-S.; Yoon, Y.-S.; and Bien, Z. Kares (1998), "Intelligent rehabilitation robotic system for the disabled and the elderly. Proceedings of the 20th Inter. Conf. of the IEEE Engineering in Medicine and Biology Society, Vol. 5, pp. 2682–2685.
- Dario, P.; Laschi, C.; and Guglielmelli, E. (1999), "Design and experiments on a personal robotic assistant.", Advanced Robotics 13(2), pp.153–69.
- Takahashi, Y.; Kikuchi, Y.; T. Ibaraki; and Ogawa, S. (1999), "Robotic food feeder.", Proceedings of the 38th International Conference of SICE, pp. 979–982.
- Jae-Bok Song and Kyung-Seok Byun (2006), "Design and Control of an Omnidirectional Mobile Robot with Steerable Omnidirectional Wheels", Mobile Robots, Moving Intelligence, pp. 576.
- Carlisle, B. (1983) "An Omnidirectional Mobile Robot", Development in Robotics, Kempston, pp.79-87.
- Pin, F. & Killough, S. (1999), "A New Family of Omnidirectional and Holonomic Wheeled Platforms for Mobile Robot", IEEE Transactions on Robotics and Automation, Vol. 15, No. 6, pp. 978-989. <http://www.hagisonic.com/>
- Jie-Tong Zou, Kuo L. Su and Feng-Chun Chiang (2010), "The development of the Omnidirectional Home Care Mobile Robot", The Fifteenth International Symposium on Artificial Life and Robotics (AROB 15th '10), B-Con Plaza, Beppu, Oita, Japan, Feb. 4- 6.

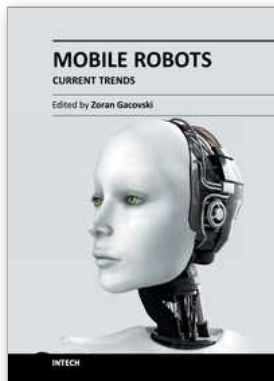

Mobile Robots - Current Trends

Edited by Dr. Zoran Gacovski

ISBN 978-953-307-716-1

Hard cover, 402 pages

Publisher InTech

Published online 26, October, 2011

Published in print edition October, 2011

This book consists of 18 chapters divided in four sections: Robots for Educational Purposes, Health-Care and Medical Robots, Hardware - State of the Art, and Localization and Navigation. In the first section, there are four chapters covering autonomous mobile robot Emmy III, KCLBOT - mobile nonholonomic robot, and general overview of educational mobile robots. In the second section, the following themes are covered: walking support robots, control system for wheelchairs, leg-wheel mechanism as a mobile platform, micro mobile robot for abdominal use, and the influence of the robot size in the psychological treatment. In the third section, there are chapters about I2C bus system, vertical displacement service robots, quadruped robots - kinematics and dynamics model and Epi.q (hybrid) robots. Finally, in the last section, the following topics are covered: skid-steered vehicles, robotic exploration (new place recognition), omnidirectional mobile robots, ball-wheel mobile robots, and planetary wheeled mobile robots.

How to reference

In order to correctly reference this scholarly work, feel free to copy and paste the following:

Jie-Tong Zou (2011). The Development of the Omnidirectional Mobile Home Care Robot, Mobile Robots - Current Trends, Dr. Zoran Gacovski (Ed.), ISBN: 978-953-307-716-1, InTech, Available from: <http://www.intechopen.com/books/mobile-robots-current-trends/the-development-of-the-omnidirectional-mobile-home-care-robot>

INTECH
open science | open minds

InTech Europe

University Campus STeP Ri
Slavka Krautzeka 83/A
51000 Rijeka, Croatia
Phone: +385 (51) 770 447
Fax: +385 (51) 686 166
www.intechopen.com

InTech China

Unit 405, Office Block, Hotel Equatorial Shanghai
No.65, Yan An Road (West), Shanghai, 200040, China
中国上海市延安西路65号上海国际贵都大饭店办公楼405单元
Phone: +86-21-62489820
Fax: +86-21-62489821

© 2011 The Author(s). Licensee IntechOpen. This is an open access article distributed under the terms of the [Creative Commons Attribution 3.0 License](#), which permits unrestricted use, distribution, and reproduction in any medium, provided the original work is properly cited.