

Heritability of Face Recognition

Ingo Kennerknecht¹, Claudia Kischka¹, Claudia Stemper¹,
Tobias Elze² and Rainer Stollhoff³

¹*Institute of Human Genetics, Westfälische Wilhelms Universität Münster*

²*Schepens Eye Research Institute, Harvard Medical School, Boston, MA.*

³*Max Planck Institute for Mathematics in the Sciences, Leipzig*

^{1,3}Germany

²USA

1. Introduction

To access facial information about identity certainly belongs to the highest visual skills and is part of “visual intelligence” (Hoffman 1998). Faces *per se* are crucial for nonverbal communication and necessary for directing ones attention (e.g. by gaze direction) and for effective social interactions. Face perception provides a multitude of different information and awareness of that provides critical information about social status, health status, physical attractiveness, gender, age, allowing considerations about one’s, life style, nutritional condition, or eventually premature aging. Sexual attractiveness is perceived not only consciously but also unconsciously. An elevated but still physiological level of testosterone in males results in a receding forehead/hairline and is significantly more common in politicians representing “alpha leader”. Woman mate preferences differ according to their cycle-based fertility status regarding among other cues men’s facial masculinity (Gangestad et al. 2010). Also, faces allow on-the-spot diagnosis of many genetic syndromes (Gorlin et al. 2001).

Face perception (to see a face as a face) is predominantly triggered by the T-shape order of eyes, nose, mouth (Tsao and Livingstone 2004). Face perception is followed by face processing which finally may result in face recognition. Humans are extremely competent to recognize someone by the face alone. This high cognitive skill is very robust and also very rapid and allows individualizing a face out of thousands of familiar and unfamiliar faces. The false-negative and false-positive rates of these multiple daily decisions appear to be extremely low. Face perception is characterized by its simultaneous sensitivity and insensitivity to subtle changes. On the one hand subtle changes complicate the representation of invariant aspects of faces necessary for face recognition. On the other hand these changeable aspects play a central role for social communication (Haxby et al. 2002). Constitution will fluctuate depending on changing life style or physical exercise which is reflected in the face like facial rash; facial skin might be clean, bright, youthful; lips might be dry, cracked, puffy; eyes might be dark, bruised appearance below the eyes. However, face recognition ability is not significantly hampered by these changes.

How face recognition functions is coming into the focus of interest by an increasing number of disciplines ranging from neurology, psychiatry, psychology, genetics to computational sciences and mathematics. The face recognition development process during growth and maturation of the brain is still being debated.

There is ample evidence that face recognition is a highly specific cognitive ability that is highly heritable. A positive proof of inheritance of face recognition ability comes from twin studies (Polk et al. 2007, Wilmer et al. 2010). Based on extensive studies in large families we could show that the specificity and heritability is also true for the extreme low end of the face recognition ability (i.e. face blindness, syn. prosopagnosia). The term *prosopagnosia* (PA) was first introduced by Bodamer (1947) by assimilating the greek words *prosopon* for "face" and *agnosia* for "not knowing, ignorant". We are aware of an intra-familial continuum in the congenital ability of face recognition: From exceptionally poor face recognition to poor, good, and extraordinary face recognition ability (i.e. super recognizers). People who lack the ability of face recognition but exhibiting normal object recognition are extremely valuable in the delineation of the physiology of face recognition. The most convincing evidence that face recognition functions as a heritable unit - irrespective of a putative modular or distributed neuronal processing - comes from prosopagnosic family studies. These are families in which non-functioning face recognition segregates in a regular pattern. Congenital prosopagnosia as a counterpart of face recognition ability may serve as a model for further studies on high functioning visual recognition.

2. Face perception and recognition

Faces are a special class of visual stimuli and there is a significant face preference already seen in newborns. They look significantly longer at a direct gaze than at an averted gaze and there is an enhanced neuronal processing of faces in 4-month-old infants (Farroni et al. 2002).

2.1 Evolution of the visual information gathering and processing system

According to the often cited expression by Theodosius Grigorevich Dobzhansky (Феобосий Гризюрбеец Добржанский, 1900-1975) "*Nothing in biology makes sense except in the light of evolution*" we want to argue that the eyes (i.e. information gathering system) and the brain (i.e. information processing system) are under strong genetic control and cooperate evolutionarily in the same environmental context (Fig. 1).

2.1.1 Eye development

In the course of evolution more than 40 different eye types have been generated. There are three major eye-types, the camera-type eye with a single lens (in vertebrates), the compound eye with numerous repeating units the ommatidia (in insects), each of which functions as a separate visual receptor, and the mirror eye with a lens and a reflecting mirror (in scallops). For long a coincidental, i.e. independent evolutionary development was stated. Recent studies on genetics control of eye development now clearly supported a monophyletic (i.e. a common) origin of the eyes in evolution. This was essentially based on findings of a gene regulatory network controlling eye development in drosophila (for review see Gehring 2005). In a process of evolutionary tinkering, a cascade of some 2,000 genes is involved for eye morphogenesis. A master-control-gene thesis was proposed which is successfully tested.

It could be shown that these genes are switched on by the gene PAX6 (review van Heyningen and Williamson 2002) (Fig. 1).

2.1.2 Development of the brain

As the optic nerve is rather part of the brain than a “nerve” it is only consequent to assume that the visual processing system of the visual cortex of the brain evolved hand in hand with the information gathering system - the eye (Fig. 1). In the last decade a slowly increasing number of papers support a substantial genetic control and environmental influence. This is true for the total brain volume which differs between ethnic groups as well as partial morphometric measures including total gray and white matter (Baare et al. 2001, Joshi et al. 2011, Hulshoff Pol et al. 2006), cortical thickness (Schmitt et al. 2008, Lenroot et al. 2009, 2010) or visual fine structure (in the cat, Kashube et al. 2002). Also the white matter integrity and connectivity is beside some environmental input under genetic control (Pfefferbaum et al. 2001, Chiang et al. 2009, 2011). Total lack of visual experience affects the fine structure of visual cortex neurons (Wallace et al. 2006). In case of face recognition ability early visual input is necessary for developing full expertise (LeGrand et al. 2003, 2006). But maturation starts before the onset of vision and there is ample evidence that genetics also plays an important role during development of neural circuitry of face processing (Luo et al. 2008, Polk et al. 2007, Tropea et al. 2011). It is suggested that full quantitative maturity is reached latest at 5-7 years of age (Crookes & Kone 2009).

2.2 Processing and recognition of faces

In general, facial information processing comprises a number of different processes targeted at extracting different kinds of information. The resulting processing complexity was first addressed at a functional level by conceptual models of face recognition which aimed at separating different processing stages, e.g. by Hay and Young (1982) in a linear hierarchic model and by Bruce and Young (1986) in a box-and-arrow model which is still considered a standard reference model (Fig. 2). As a box-and-arrow model the focus is on a conceptualization of functional steps but no reference is provided as to how these steps could be achieved by specific information processing and where in the brain these processing modules could be located. The latter has been clarified to some extent by more recent imaging studies revealing a distributed neural system of face recognition (Haxby et al. 2000, see Fig. 3).

2.2.1 Modular vs. distributed face processing

In 2001 two papers appeared in the same volume of the Science Magazine. One supporting a modular (Downing et al. 2001) the other a distributed fashion (Haxby et al. 2001) of processing and finally of recognizing faces in the brain. Cohen and Tong 2001 comment on this seemingly alternate or controversial findings: *“We can imagine a variety of possible intermediate or alternative positions: a heterogeneous mix of special purpose modules and more distributed general mechanisms; representations that appear modular at one scale but distributed at finer scales; or representational structure that does not divide along the lines of common stimulus categories (such as faces versus objects) but rather is organized along more complex or abstract dimensions”*.

Quiroga et al. (2005) even showed visual representation by single neurons in the medial temporal lobe. As the same neurons also report when showing the written name of the same individual these cells might simply be memory cells and might express maximal compact or sparse coding.

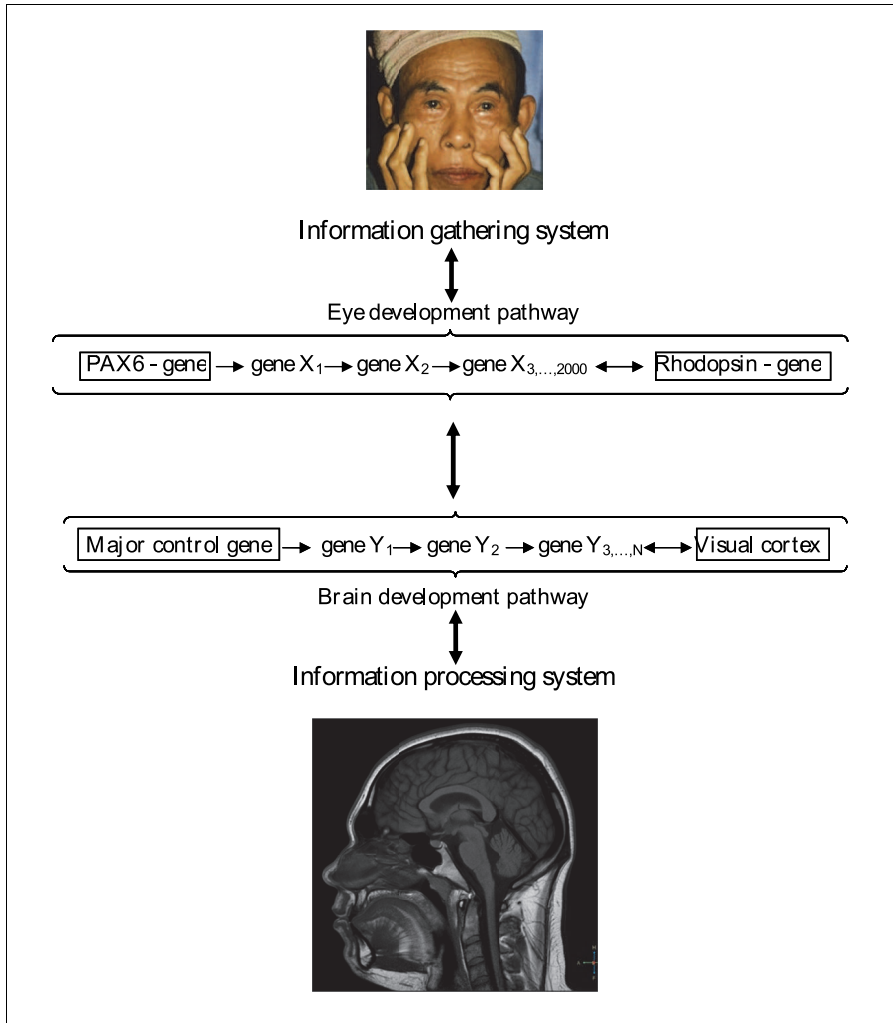

Fig. 1. Hypothetical evolution of the visual systems of eye and brain. The morphogenetic pathways consist of the information-gathering system and the information-processing system. Both are not linear but rather a complex network. The “eye development pathway” is partially adopted from Gehring & Ikeo 1999, Gehring 2005). Evolution started with eye pigment coded by the Rhodopsin gene and accidentally by a universal master control gene PAX6. Successively new genes were acquired stochastically and evolutionarily optimized – this has been termed “intercalary evolution” (Gehring & Ikeo 1999). There is an estimate of around 2,000 genes required for eye morphology only (Halder et al. 1995). In analogy to the eye also the brain with the neuronal visual system might fit the concept of intercalary evolution. In a bilateral response both the eye and the visual cortex had been successively adapted and optimized. (MRT image of the head by courtesy of Stanislaw Milachowski, Department of Radiology, Westfälische Wilhelms University, Münster, Germany).

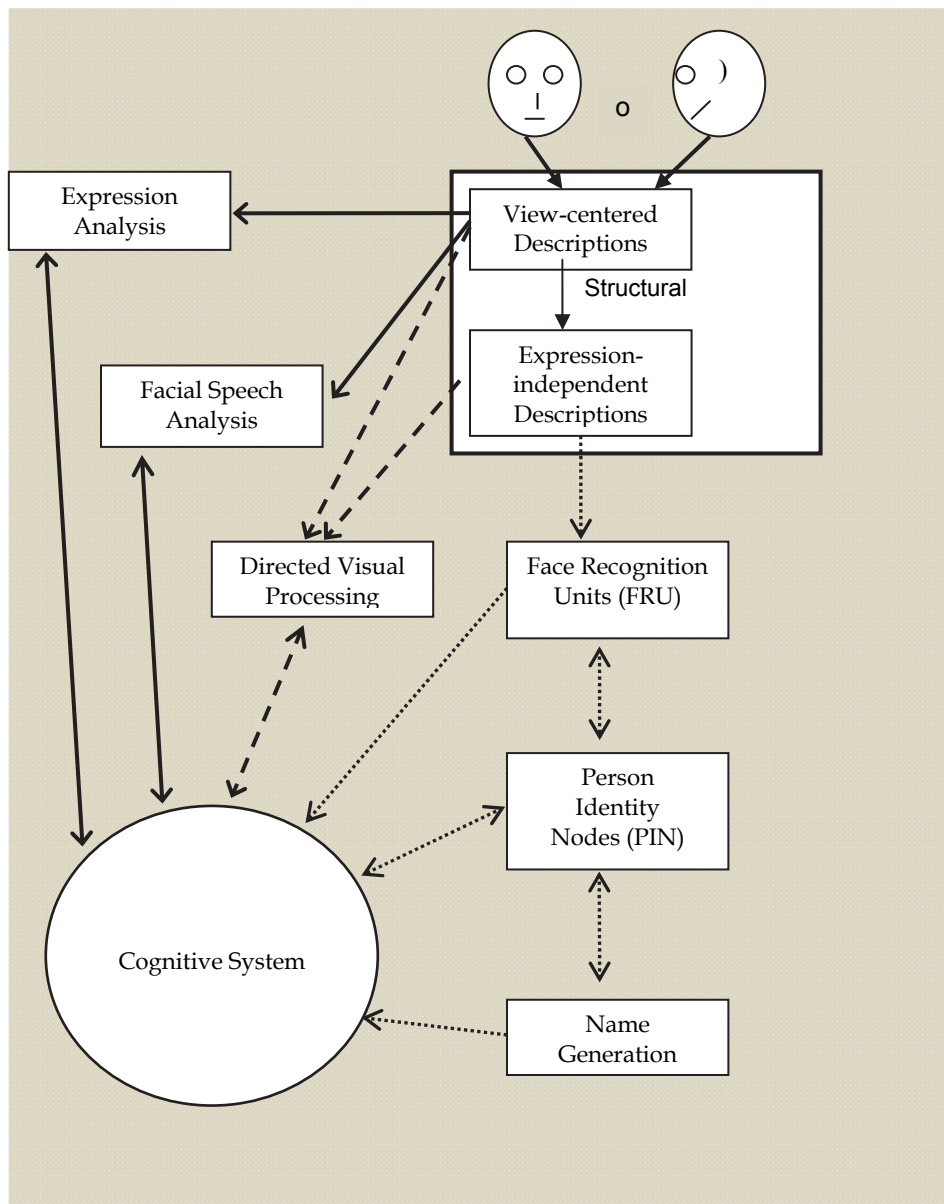

Fig. 2. A two dimensional box-and-arrow diagram for illustrating a functional model for face recognition (modified from Bruce & Young 1986, Deffke 2005). The central idea of the model is the clear distinction between face recognition unit (FRU) and the person identity nodes (PIN). It is also assumed that the person identity nodes - for each individual there should be one - can be accessed via the voice, the name, or facial markers like the hair line. Dotted arrows denote the processing of familiar faces and dashed arrows the processing of unfamiliar faces.

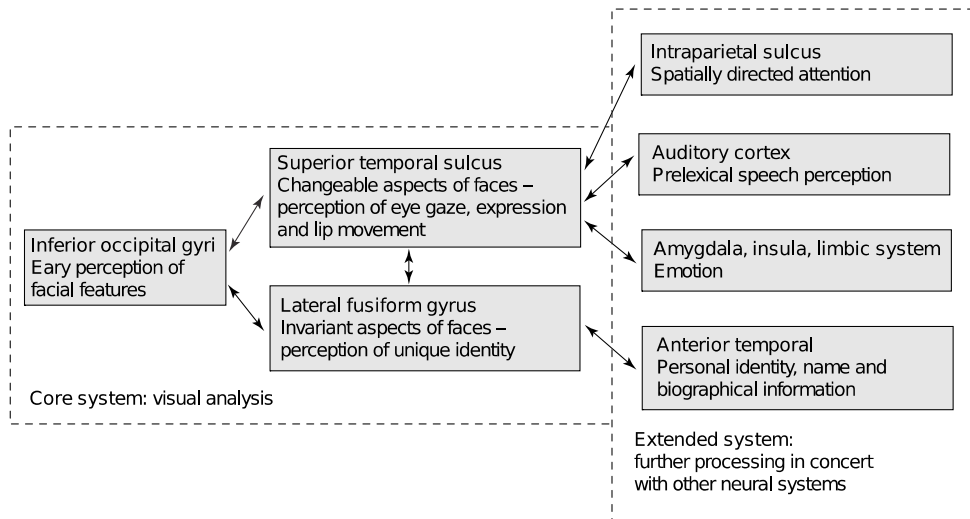

Fig. 3. A schematic depiction of the distributed neural system for face recognition (adapted from Haxby et al., 2000).

2.2.2 Face specific neuronal processing vs. unspecific high resolution pattern recognition

A strongly debated question is whether and how face processing differs from non-face processing. It is argued that face recognition has a specific neuronal processing (Kanwisher et al. 2000) and that it is not just an instance of higher order object recognition. Others propose that face recognition is just a specific instance of visual expertise and the same neuronal mechanisms and areas are also recruited by bird, dog or car experts in their field of expertise (Gauthier et al. 2000, Gauthier and Bukach 2007). While it is undisputed that faces are processed in specific areas, the debate is still ongoing as to whether these areas are exclusively recruited for the recognition of faces (domain-specificity). More generally, this debate can be framed as part of the more general nature vs. nurture discussion and is still ongoing (Pascalis et al. 2009, Park et al. 2009, Robbins and McKone 2007, 2010).

In analogy to face recognition it has also been suggested that the human voice is an “auditory face” (Belin et al. 2004) based on auditory expertise (Chartrand et al. 2008).

For more than a decade it is known that face recognition is a very quick function of the brain. As early as 100 to 120 ms there is a electrophysiological response to emotional faces or face categorization and after 170 there is an event related potential (called N170) associated with face recognition (Eimer & Holmes 2002, Liu et al. 2002). This supports the idea that special neuronal pathways for visual recognition of faces exist. This hypothesis of face-specific processing pathways is further substantiated by brain imaging studies (functional brain mapping studies, fMRI). Brain areas in the occipito-temporal cortex preferentially response to faces. In particular in the mid-fusiform area (FFA) there is a significant response when someone is seeing a face but much less to non-facial objects (Behrman et al. 2005). The same is true for the inferior occipital gyrus (IOG) (Hoffman & Haxby 2000). Interestingly also an evolutionary old brain area beyond the cortex and the amygdala responds significantly to

faces (Behrman et al. 2007). The relevance for face processing of the FFA is also supported by patients who suffered a sudden loss of face recognition ability after a traumatic event covering this area (e.g. Steeves et al. 2009). In a recent study with a large sample of people who lack face recognition ability from childhood without any detectable brain damage some anatomical and functional differences to a control collection could be seen. In particular a diminished gray matter density in the bilateral lingual gyrus, the right middle temporal gyrus, and the dorsolateral prefrontal cortex. A decreased functional activity in the left fusiform face area and the dorsolateral prefrontal cortex. An enhanced activation in the left medial prefrontal cortex and the anterior cingulate. This is suggestive of a network dysfunction and anatomic curtailing of visual processing in the lingual gyrus (Dinkelacker et al. 2011).

Experimental investigations of differences in face and object recognition are complicated by the fact that for most people faces are the only area of visual expertise. Thus, a direct comparison of neural recruitment for different areas of expertise, which would be needed to distinguish between the two conflicting views on face specificity, is most often not possible.

From a theoretical viewpoint there are clearly differences in the processing of objects as stimuli belonging to a specific class or as stimuli idiosyncratically displayed by a specific individual (Stollhoff 2010, 2011 a, b). By incorporating these differences into models of facial encoding, Stollhoff et al. (2011b) provided a link from deficits in face recognition (behavioral level), via a lack of holistic processing (computational level) to decreased structural neural network connectivity (implementation level). Whether or not this link also holds in the reverse direction such that a comparatively increased neural connectivity is specific to the processing of faces in contrast to the more general visual expertise still needs to be investigated.

2.2.3 High functioning and low functioning face recognition

There is a broad distribution of face recognition ability in humans. From daily experience we are not only aware of people with ordinary face recognition ability but also of some who are extremely good but also some who are very poor. An increasing number of papers support that the variability of face recognition ability in humans is even much higher than hitherto thought. In the context of studies with very poor recognizers (i.e. "face-blind" people or prosopagnosics, see chapter 2.4.4) there were self-reports of people who claimed that their ability is just opposite. These people with exceptionally good face recognition ability were called "super-recognizers" (Russell et al. 2009).

2.3 Heritability of neurocognitive functions and dysfunctions

There is an increasing but still surprisingly low number of isolated neurocognitive deficits with a proven or suspected genetic background. Such demonstrable impairments in visual, auditory, tactile, smell and other perceptions also help to characterize the normal basic neuronal mechanisms that have an impact on multiple brain modalities (Tab. 1).

2.4 Heritability of face perception and recognition

There is converging evidence that face recognition is highly heritable. The neurogenetic background and heredity of visual intelligence can be achieved through an increasing number of very different approaches.

2.4.1 Evolution of face perception and recognition

"Evolution is best understood as the genetic turnover of the individuals of every population from generation to generation" (Mayr 2001). Visual expertise of face recognition is evolutionarily conserved in distant species telling us about a strong genetic background. There are many reasons for improving face recognition over non-facial recognition. One reason might be described by "preparedness" (Seligman 1970, cit. in Öhman 2005). Hunter-gatherers sitting in a palaeolithic cave certainly will have an increased chance to survive when they can decide immediately whether the face of someone looking inside is a family member or a stranger and a putative enemy. Better survival means better reproduction. Depending on the selective pressure even a slight advantage can drive evolution. Since ancient times it is of common knowledge that elephants never forget a (human) face – at least when associated with aversive events. Sheep underwent behavioral and electrophysiological tests for visual face recognition of faces (Kendrick et al. 2001). In a number of trials these sheep could accurately discriminate not only individual sheep faces but also human faces even after 600 days. Such a high visual expertise is also reported in social insects with much simpler nervous systems. The paper wasps (Tibbetts and Dale 2004) and honeybees (Dyer et al. 2005) are able to recognize conspecifics by facial cues only. In honeybees this ability is also shown for human(!) faces. It should be mentioned that honey bees have less than 1 million neurons in contrast to 100 billion neurons in humans (Pakkenberg and Gundersen, 1997). As the experiment only tested recognition of specific face images, and not the ability to generalize across different views, successful completion of the experiment would have been possible without an engagement of all of the cortical processes normally involved in face recognition.

Neurocognitive functions/dysfunctions	Gene(s)	known mutation	Chromosome locus	Mendelian phenotype	OMIM
Hereditary prosopagnosia, congenital prosopagnosia	NN	-	unknown	AD, suspected	610382
Dyslexia 1	DYX1	+	15q21	AD, multifactorial	127700
Dyslexia 1C1	DYX1C1	+	15q21	QTL suspected	608706
Dyslexia 2	DYX2	-	6p21.1	AD, QTL, multifactorial	600202
Dyslexia 3	DYX3	-	2p16-p15	AD, multifactorial	604254.
Dyslexia 4	DYX4	-	6q11.2-q12	multifactorial	127700
Dyslexia 5	DYX5	-	3p12-q13	multifactorial	606896.
Dyslexia 6	DYX6	-	18p11.2	multifactorial	606616
Dyslexia 7	DYX7	-	11p15.5	multifactorial	127700
Dyslexia 8	DYX8	-	1p36-p34	AD, multifactorial	608995
Dyslexia 9	DYX9	-	Xq27.3	multifactorial	300509
Achromatopsia, syn. Pingelapese blindness, total colorblindness with myopia	ACHM3	-	unknown	ar, suspected	262300

Neurocognitive functions/dysfunctions	Gene(s)	known mutation	Chromosome locus	Mendelian phenotype	OMIM
Congenital stationary night blindness type 1A	CSNB 1A	-	Xp11.4	X-linked	310500
Congenital stationary night blindness type 2A	CSNB 2A	-	Xp11.23	X-linked	300071
Congenital stationary night blindness type 1B	CSNB 1B	-	5q35	ar	257270
Congenital stationary night blindness type 2B	CSNB 2B	-	11q13.1	ar	610427
Congenital stationary night blindness type 1C	CSNB 1C	-	15q13-q14	ar	613216
Congenital stationary night blindness autosomal dominant 1	CSNBAD1	-	3q21-q24	AD	610445
Congenital stationary night blindness autosomal dominant 2	CSNBAD2	-	4p16.3	AD	163500
Congenital stationary night blindness autosomal dominant 3	CSNBAD3	-	3p21	AD	610444
Familial developmental dysphasia	NN	-	unknown	AD, suspected	600117
Speech-language disorder 1, syn. SLD orofacial dyspraxia SPCH1	FOXP2	-	7q31	AD / multifactorial	602081
Specific language impairment 1	SLI1	-	16q	multifactorial	606711
Specific language impairment 2	SLI2	-	19q	multifactorial	606712
Specific language impairment 3	SLI3	-	13q21	multifactorial	607134
Specific language impairment 4	SLI4	-	7q35-q36	multifactorial	612514
Speech-sound disorder, SSD	same locus DYX5	-	3p12-q13	multifactorial	608445
Hereditary whispering dysphonia	NN	-	unknown	AD, suspected	193680
Musical perfect pitch, syn. absolute pitch	AP	-	unknown	AD, multifactorial, suspected	159300.
Musical aptitude quantitative trait locus	MUSQTL1	-	4q22	multifactorial, suspected	612343
Tune deafness , syn. congenital dysmelodia, amusia	NN	-	unknown	AD	191200
Congenital indifference to pain, syn. congenital analgesia	SCN9A NN	+	2q24 unknown	ar AD	243000 147430
Congenital anosmia	ANIC	-	18p11.23- q12.2	AD	107200
Inability to smell musk	NN	-	unknown	ar, suspected	254150
Inability to smell isovaleric acid	NN	-	unknown	ar, suspected	243450

Neurocognitive functions/dysfunctions	Gene(s)	known mutation	Chromosome locus	Mendelian phenotype	OMIM
Synesthesia	SYNSTH	-	2q24.1		612759
Contactin-associated protein-like 2 (speech)	CNTNAP2	+ → SLI	7q35-q36		604569

Table 1. Neurocognitive functions and dysfunctions with known genetic background. The data are collected from the most comprehensive genetic database *Online Mendelian Inheritance in Man*TM (World Wide Web URL: <http://www.ncbi.nlm.nih.gov/omim/>) (Abbreviations AD = autosomal dominant, ar = autosomal recessive, QTL = quantitative trait locus).

2.4.2 Gender bias for face recognition

Sex differences of a variety of cognitive functions are known (Rehman and Herlitz 2006). Women outperform men in their ability to recognize female faces. When shown male faces both perform on similar levels (Rehman and Herlitz 2006). The authors have no explanation for the neurophysiology of this female driven own-sex-bias. On the other hand there is a positive correlation of verbal IQ and face recognition in men but not(!) in women (Herlitz and Yonker 2002). Nothing indicates that this sex-biased advantage is a result of social or cultural learning only. As gender and a variety of secondary sexual characteristics are strongly genetically determined also genetic modification of sex-biased face recognition might be assumed. A causal interpretation still requires caution. Epigenetic mechanisms also might in part or fully explain these differences. The term epigenetic refers to modification of the DNA that does not alter the DNA sequence. The DNA stores the genetic information and the expression of genes results e.g. in the processing of structural and regulatory proteins. It is now known that this basic genetic information stored in the DNA is just optional. The reason is that the genetic information underlies large modifications (e.g. by methylation). This is also called "imprint". By this not the gene sequence is altered but the way the specific information is processed, e.g. by enhancing or silencing gene expression. Thus epigenetics enables different read-outs from a fixed template (review Egger et al. 2004, Fagiolini et al. 2009).

2.4.3 Twin studies

As already delineated there is no doubt that the morphological and functional brain development is under genetic control. Yet, knowledge about the heritability of cognitive skills is still poor. Best described is the genetic impact of superior general intelligence (Haworth et al. 2010). A classical approach to behavioural genetic traits which do not follow simple Mendelian inheritances are twin studies. Such studies allow an estimate of the respective environmental and genetic contribution to a given phenotype. Identical or monozygotic twins are genetically almost similar. Hence, the more discordant they are for a behavioural trait the less heritable and the more environmental effects account for the phenotype. In other words, best proof for high heritability are concordant monozygotic twins which are grown up in different families. By such studies the heritability of general cognitive ability (mostly called *g*) was estimated. Results from different studies vary. Meta-analyses of such studies give heritability estimates of 50%, i.e. half of the total variance in *g* is due to genetic difference between individuals (Harworth et al. 2010). In a functional

magnetic resonance imaging twin study a significant influence of genetic similarity on the cortical response is shown for face and place stimuli but not for objects like chairs. Monozygotic twins showed a significantly more similar neural activity pattern than dizygotic twins (Polk et al. 2007). In a recent twin study it was shown that such genetic differences can account not only for face perception but also for face recognition ability. Monozygotic and dizygotic twins underwent a face memory test (Cambridge Face Memory Test, CFMT). The monozygotic vs. dizygotic intraclass correlation was 0.70 vs. 0.29, giving evidence of high heritability of face recognition ability (McKone 2010, Wilmer et al. 2010). Zhu et al. (2010) also demonstrated in a large twin study by cognitive tests (old/new recognition task), face inversion test, composite test and global-local test that monozygotic twins are more correlated than dizygotic twins for the specific ability of face perception.

2.4.4 Hereditary prosopagnosia (i.e. non-functioning face recognition)

The strongest support for heritability of face recognition *per se* comes from the counterpart. There is a dysfunction in the neuronal processing of face recognition which is called *prosopagnosia*. Prosopagnosia is a specific inability to recognize familiar faces. The synonym *face blindness* is misleading as the perception of human faces is preserved. The term prosopagnosia was coined by Bodamer in 1947 as an assimilation of the Greek words prosopon (πρόσωπον) meaning face and agnosia (αγνοσία) meaning not knowing, not recognizing or ignorant. He came across the phenomenon of acquired prosopagnosia when examining soldiers suffering from brain injuries. In a detailed review of the literature he states that the first well documented clinical descriptions of an agnosia would be from Quaglino (1867)(cited by Bodamer 1947). Della Sala and Young (2003) come back to that case showing that this observation is very typical for prosopagnosia. The oldest convincing report is from Wigan (1844) describing a man who is not able to remember faces: *“He would converse with a person for an hour, but after an interval of a day could not recognise him again. Even friends, with whom he had been engaged in business transactions, he was unconscious of ever having seen. Being in an occupation in which it was essential to cultivate the good-will of the public, his life was made perfectly miserable by this unfortunate defect, and his time was passed in offending and apologizing”*. These cases have in common that they are acquired by traumatic events or strokes.

Only recently, an increasing number of cases with an idiopathic form of prosopagnosia – mostly called congenital or developmental form - in the absence of any exogenous event are reported (review Behrmann and Avidan, 2005). Until 2003 three reports about familial segregation were published clearly supporting the heredity of “non”-face recognition (De Haan 1999, Galaburda and Duchaine 2003, McConachie 1976) (Fig. 4).

In contrast to the rare acquired form of prosopagnosia, the inborn form of prosopagnosia is among the most common anomalies in humans with a prevalence of around 2% (Bowles et al., 2009, Kennerknecht et al. 2006, 2007, 2008a). Most interestingly these cases almost always run familiar following a simple mode of segregation patterns (Kennerknecht et al. 2008b). We therefore coined the term hereditary prosopagnosia (Schwarzer et al. 2006, Grüter et al. 2007, Kennerknecht et al. 2006).

Such recurrent disorders of higher visual function may help to delineate normal neuronal processing. The function of a gene can be tested in the laboratory by genetically engineered mice either by turning off gene expression by targeted mutation or rudely by knocking out the gene physically (“knock-out mouse”). Mice have gradually become a model system in

vision research (Luo et al. 2008, Wang et al. 2010, Zhang et al. 2007). From a genetic approach the prosopagnosic subjects might serve as “natural knock-out” humans for loss-of-function experiments for the module “face recognition”. So far no genes or candidate genes are known to be associated with the development of visual processing or in particular with face processing and face recognition. However, formal genetic studies of familiar transmission of dysfunctions of the visual intelligence are powerful tools to guide molecular genetic dissection.

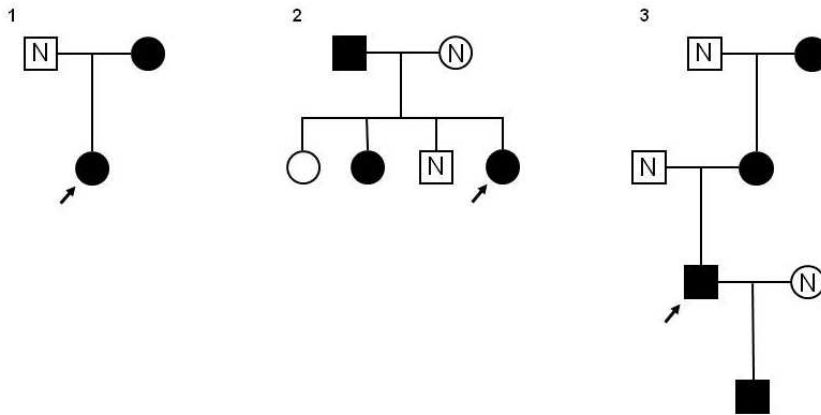

Fig. 4. First published observations of familial transmission of congenital face blindness. The pedigrees were drawn according to the descriptions given in the original papers. An arrow indicates the index subject, filled symbols *prosopagnosia*. (1) McConachie 1976): “[The] mother also claims not to be able to recognize familiar faces. She suggests that as a child she had less difficulty, than her daughter because she lived in a small community, and went to a school where no uniform was worn. She remembers believing that a family friend was two different people until one day he put on his spectacles in her company. She has found ways, over time, of overcoming the handicap, for example, by using tone of voice for recognition.” (2) De Haan (1999): “The eldest daughter – who had reportedly no face recognition difficulties – declined to participate) [...] The results [...] are clear cut. Both daughters and the father displayed definite problems in the recognition of familiar faces. [...] ... the son performed in the normal range.” (3) Galaburda and Duchaine (2003): “TA’s [see arrow] son, mother and grandmother also have prosopagnosia, it clearly has a genetic basis”.

Besides functional testing the diagnosis can also be established by highly informative narratives about situations where family members or very close friends have been overlooked. This can further be substantiated by the finding of compensation strategies for overcoming such problems. E.g. normal sighted (emmetropic) prosopagnosics apologize for having forgotten their glasses or for having been kept in thought. Such compensation strategies are otherwise very rare in control collections.

The question is whether the prosopagnosic phenotype can be unambiguously distinguished from poor face recognition ability? (Fig. 5A). If there are overlapping features it might be argued that these could be due to individual development of a more or less effective compensation strategies and/or clinical distinct severity of symptoms and/or part of

varying methods of assessment (Minnebusch et al. 2007, LeGrand et al. 2006, Stollhoff et al. 2010, 2011 a, b) (Fig. 5B).

Prosopagnosics and controls show only as a group statistically significant differences by behavioural and physiological tests. On an individual level there is always an overlap in the performance of some control and prosopagnosic individuals in a varying number of tests. Moreover there is no single test available today which unambiguously allows to differentiate between a poor recognizer (at the lower end of the normal face recognition distribution) and a prosopagnosic (at the extreme low end).

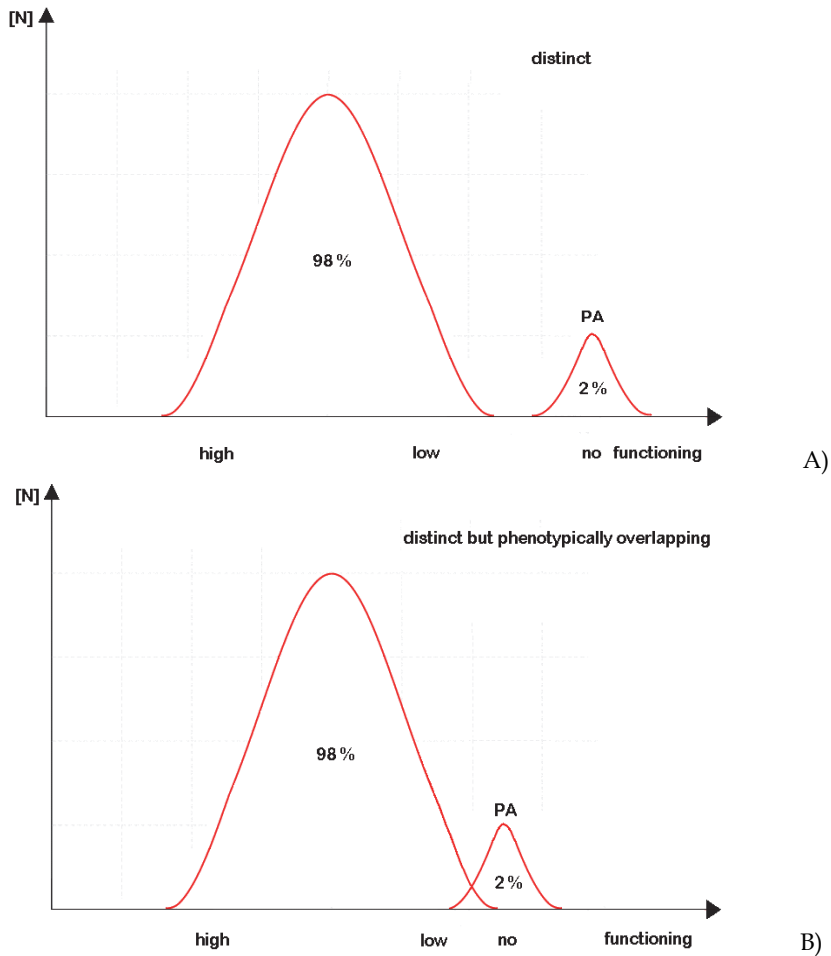

Fig. 5. Phenotypic distributions of face recognition ability and prosopagnosia. A) In a given population there are people with very good, average, and poor recognition ability. Distinct from this group are those who have no face recognition ability at all. B) Now there is increasing evidence by behavioural and electrophysiological studies that the phenotypes might partially overlap. Nevertheless, both groups might still be defined as distinct entities.

In principal, studies of familial segregation of variable face recognition might help to address this topic. As prosopagnosia is of increasing scientific interest it is not surprising that intra familial variability of face recognition was described recently (Schmalzl et al. 2008, Kischka 2011) (Fig. 6).

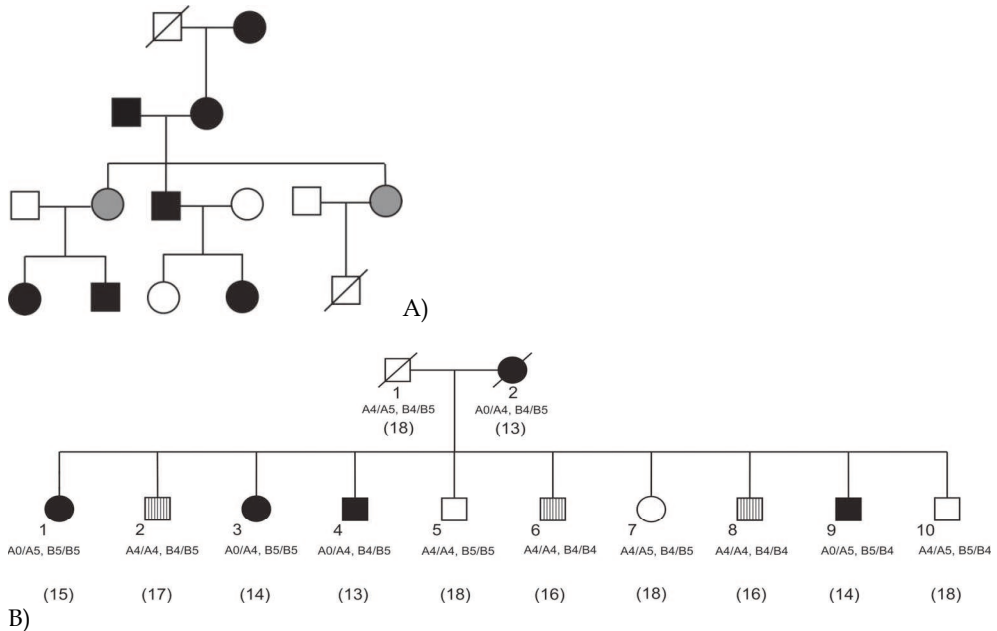

Fig. 6. Intrafamilial variability of face recognition. A) White symbols denote not impaired; black symbols denote impaired on familiarity tasks; grey symbols denote normal on familiarity task, impaired on more subtle measures of face processing (Schmalzl et al., 2008). B) White symbols denote unimpaired; shaded symbols denote face recognition ability below average; black symbols denote prosopagnosia (Kischka 2011).

Further studies will show whether the phenotypic variability follows a continuum described by a bimodal distribution (Fig. 7A) or simply by a Gaussian distribution (Fig. 7B). At the low end there are 2.5% prosopagnosics and it is assumed that at the high end there are the same number of super recognizers (Russell et al. 2009). So far this seems highly suggestive of a regular bell-shaped distribution.

2.4.5 Genetic considerations

Human face recognition is highly heritable however it's genetic basis is unclear. Based on literature and own data an attempt is made for the genetic dissection of this higher level perception and cognition skill. Different genetic traits support one or the other finding and there is ample evidence that the complex neuronal processing also has a complex genetic background. More than 2,000 genes are involved in eye development only (Halder et al. 1995). A screening for genes that wire the (visual) cortex has been started in the mouse (review Lokmane and Garel 2011). One such approach is to look in transgenic mice for defects during embryogenesis and the functional consequences on the developing cerebral

cortex. These genetic studies allow conclusions on the etiology of cerebral disorders in mice and also in humans and help to dissect the molecular pathways responsible for normal brain development.

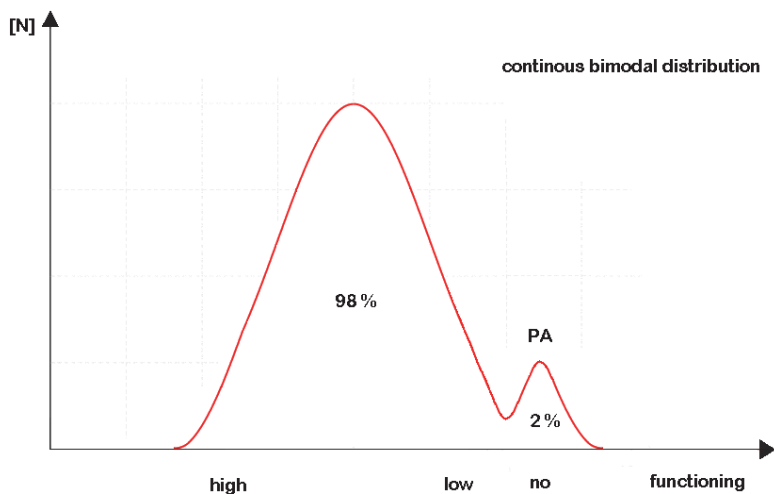

A)

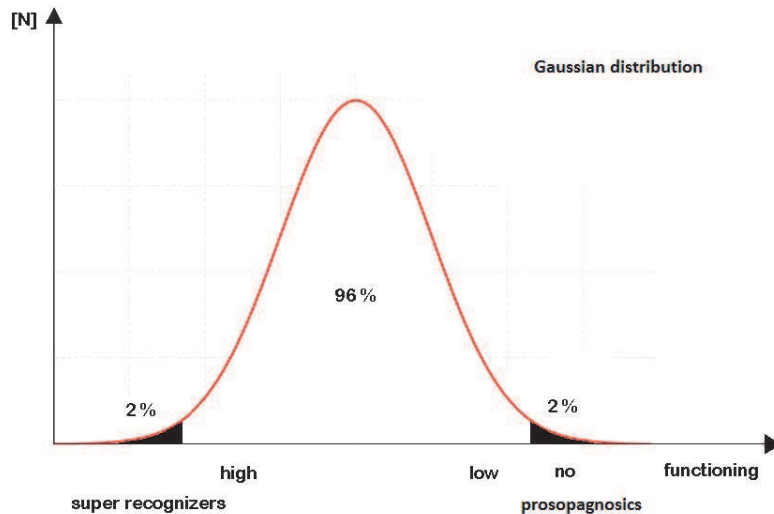

B)

Fig. 7. Face recognition ability might be continuously distributed either in a (A) bimodal way with respect to non-functioning face recognizing (prosopagnosia) or (B) alternatively, low and high performers are just tail-enders of a normal distribution.

a. Mendelian inheritance

Already the first published cases of congenital prosopagnosia showed familiar segregation and are fully compatible with a monogenic disorder of dominant phenotypic expression (Fig. 3). Dominant in that case means that the phenotype is already expressed in the heterozygous status i.e. when only one of the two inherited parental copies (alleles) shows the mutation. This is surprising as behavioral phenotypes are part of complex genetic mechanisms, environmental influences and epigenetic modifications. One explanation might be that already one dominant acting gene mutation in the molecular cascade for the processing of face recognition interrupts or disturbs the resulting neurocognitive function. Along with such an assumption all our observations of familial cases perfectly fit. We have meanwhile more than 100 families with recurrent prosopagnosia in two to four generations (the first 38 families of them are reported in Kennerknecht et al. 2008b). In favor of an autosomal dominant inheritance are (1) vertical transmission of the disorder, (2) males and females are equally impaired, and (3) father-to-son transmission. As the father only transmits the Y-chromosome to a son (but an X-chromosome to the daughter) X-linked inheritance is excluded (Fig. 8).

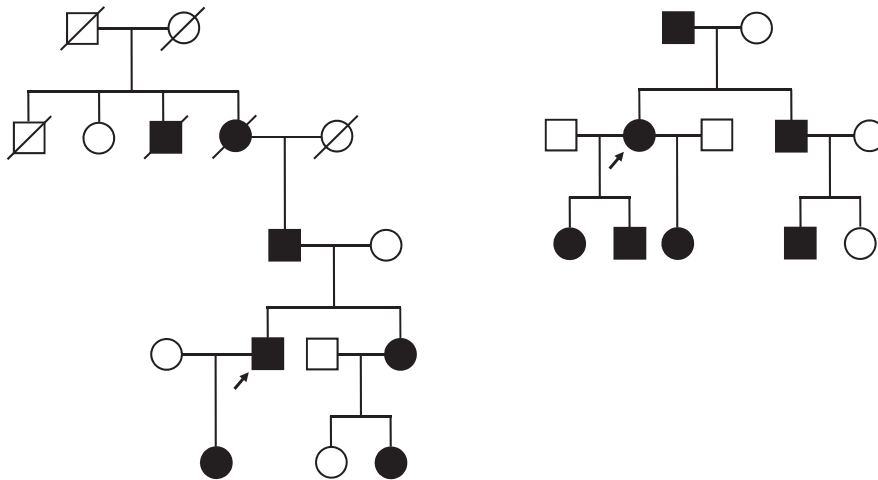

Fig. 8. Regular transmission of prosopagnosia fully compatible with autosomal dominant inheritance (modified from Grüter et al. 2007, Kennerknecht et al. 2008b)

Among 38 pedigrees (Kennerknecht et al. 2008b) only 6 exceptions were observed which are still compatible with the concept of autosomal dominant inheritance. In four families one generation is "skipped", i.e. an obligate carrier does not manifest prosopagnosia (normal transmitter) but one parent and the child(s). In two other families there is evidence of a *de novo* mutation as only one family member is impaired. It can be argued that already mutations in only one gene of the gene cascade or gene network might be sufficient in disrupting the processing of face recognition. This does not necessarily mean that all obligate carriers of such a mutation must manifest prosopagnosia. "Generation skipping" is a common phenomenon in autosomal dominant traits and is described by incomplete penetrance. Yet, it cannot be differentiated whether these are sporadic cases or isolated familial cases which are the only carriers of the mutation in a family. The genetic background (which is similar but not identical in a family) and putative epigenetic

mechanisms might modify gene expression (Fig. 9). Such formal genetic considerations are extremely helpful in dissecting molecular genetic etiology of face recognition.

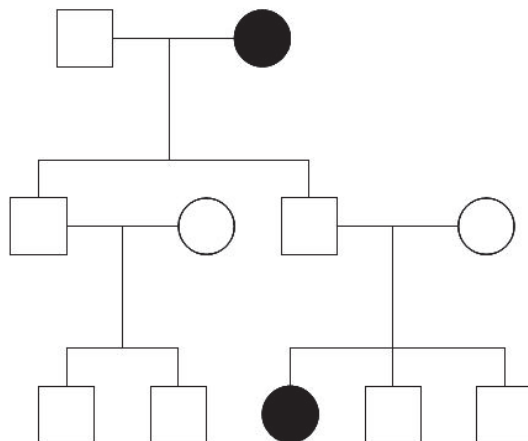

Fig. 9. Pedigree with reduced penetrance still suggestive of autosomal dominant inheritance. The father of the prosopagnosic female in the third generation is obviously a normal transmitter.

b. Polygenic inheritance

Despite large families we still do not have candidate genes. The most plausible answer is that in a certain number of families more than one gene should be mutated (polygenic inheritance). The phenotypic variability shown in our family (Fig. 3) can be simulated in the most simple way by two genes (e.g. A and B), multiple alleles, and threshold effects at which a given phenotype is expressed. The genes A and B should have several alternative forms (i.e. alleles) e.g. gene A the alleles A0, A4, and A5, gene B the alleles B4 and B5. The figures 4 and 5 denote the relative contribution to the face recognition ability. The figure 0 (zero) describes a loss-of-function mutation and should be rare in the general population. The other alleles represent the wild type and are common. Thresholds are defined for different phenotypes of high, normal, low and no recognition (prosopagnosia) ability (Tab. 2)

Threshold value	Face recognition ability	
	Genotype	Phenotype
≥ 19	(A5/A4, B5/B5); (A5/A5, B5/B4)	Super recognizer
≥ 18	(A5/A4, B5/B4); (A4/A4, B5/B5); (A5/A5, B4/B4)	Average
≥ 16	(A5/A4, B4/B4); (A4/A4, B5/B4); (A4/A4, B4/B4);	Below average
≤ 15	(A5/A0, B5/B4); (A4/A0, B5/B5); (A5/A0, B5/B5); (A5/A0, B4/B4); (A4/A0, B5/B4); (A4/A0, B4/B4)	Prosopagnosia

Table 2. Schematic genotype-phenotype correlation of assumed digenic (genes A and B), multiallelic inheritance of face recognition. The higher the figure the more it contributes to the phenotype.

According to these assumptions the prosopagnosic mother might have the genotype A0/A4 and B4/B5 and the normal father A4/A5 and B4/B5. In a two-factor-cross of the uncoupled genes the filial generation (F1 generation) predicts a variety of genotypes and resulting phenotypes (Tab. 3).

		Paternal gametes			
		A4/B4	A4/B5	A5/B4	A5/B5
Maternal gametes	A0/B4	A0/A4, B4/B4 (12)*	A0/A4, B4/B5 (13)	A0/A5, B4/B4 (13)	A0/A5, B4/B5 (14)
	A0/B5	A0/A4, B5/B4 (13)	A0/A4, B5/B5 (14)	A0/A5, B5/B4 (14)	A0/A5, B5/B5 (15)
	A4/B4	A4/A4, B4/B4 (16)	A4/A4, B4/B5 (17)	A4/A5, B4/B4 (17)	A4/A5, B4/B5 (18)
	A4/B5	A4/A4, B5/B4 (17)	A4/A4, B5/B5 (18)	A4/A5, B5/B4 (18)	A4/A5, B5/B5 (19)

* Figures denote the relative contribution of the genotype to the phenotype of the face recognition ability.

Table 3. Genotypic and phenotypic segregation ratios of a two-factor-crossing.

According to the resulting genotypes in the filial generation (see Tab. 3) the genotypes of the family members with variable face recognition ability (see Fig. 3) are simulated (Fig. 10).

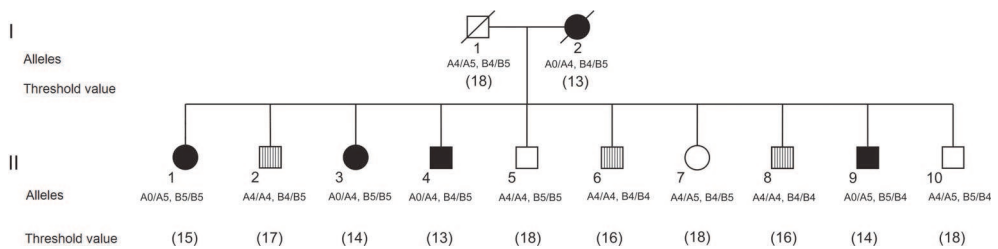

Fig. 10. Observed phenotypic distribution in a large family with assumed genotypes as derived from a hypothetical two-factor-cross (see Tab. 3).

The observed segregation ratio comes close to the expected segregation ratio (Tab. 4).







Face recognition ability	Expected segregation [N]	Observed segregation in the family of Fig. 7 [N]
 /  average	4 (25 %)	3 (30 %)
 /  below average	4 (25 %)	3 (30 %)
 /  prosopagnosia	8 (50 %)	4 (40 %)

Table 4. Genotypic and phenotypic segregation ratios of a two-factor-cross of the family described in Fig. 10.

c. Multifactorial inheritance

In a multifactorial mode of inheritance a phenotype is not entirely defined by one or more gene(s) (i.e. monogenic or polygenic) but also significantly influenced by environment and/or experience. In short, endogenic and exogenic contribution is necessary. Twin studies are an ideal approach to evaluate the relative contribution of nature and nurture. In monozygotic twins who almost completely share the same genetic background a high concordance or discordance of a given phenotype stands for a high or low genetic influence and vice versa for a low or high environmental influence. So far twin studies show a significant genetic influence on functional brain organization as documented by functional brain imaging studies (Polk et al. 2007) and by face recognition memory tests (Willmer et al. 2010).

3. Conclusion

Face recognition ability is a high level perception and recognition skill. It remains unclear whether it is neurologically processed in a modular or in a distributed manner in the cortex or subcortical structures. Also an open question is whether face recognition ability differs from object recognition or whether it is just the top functioning end of visual recognition. At all levels a consistent finding however, is the high heritability of face recognition. So far there is no gene cloned which functions in the cascade of the visual cortex. Yet, the genetics of cerebral visual function has been shown by different approaches. Here we argue that prosopagnosia may open a window on the physiology and genetics of normal face recognition (= visual intelligence). From a large collection of prosopagnosic families phenotypic heterogeneity is obvious. Preliminary molecular genetic data also indicate genetic heterogeneity. This might be due to altered gene expression of one or more genes of the gene network associated with brain development. Depending on the impairment different familiar segregation patterns are expected either following classical modes of inheritance (Mendelian phenotype), polygenic or multifactorial inheritance and/or epigenetic modifications (Fig. 11).

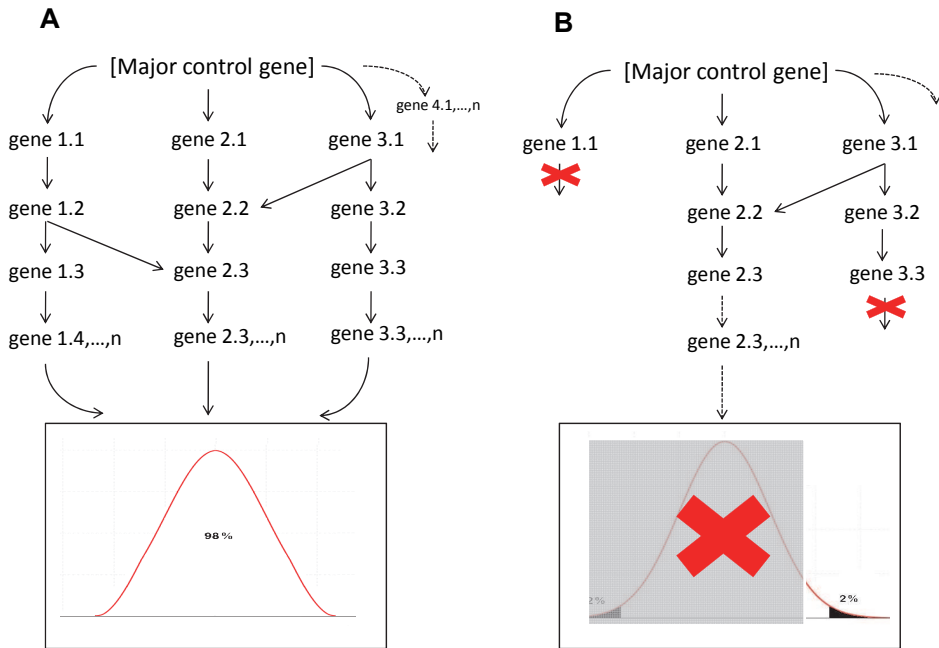

Fig. 11. A hypothetical network of genes and their respective expression that contributes to face recognition ability. Exogenic/environmental and epigenetic influences are not shown but should also play a role. A) Suggested allelic variance of the respective genes will differentially attribute to the phenotype. In a given population the face recognition ability might describe a Gaussian distribution. B) In a small subgroup one or more allelic drop-outs (e.g. by loss-of-function mutations) might occur which then result in the phenotype of poor recognizers or prosopagnosics.

By means of a permanent functional contact it can be considered that eye and brain development are simultaneously driven forward by evolution (co-evolution) as well as backward (retrograde evolution). During this process a plethora of genes had entered the network by gene duplications and successive evolutionary adaption of the duplex to its new task (intercalary evolution).

4. Acknowledgment

This project is supported by the University of Münster, Germany and approved by the local ethical committee (protocol No 3XKenn2).

5. References

- Baare, W. F. C., H. E. H. Pol, D. I. Boomsma, D. Posthuma, E. J. C. de Geus, H. G. Schnack, N. E. M. van Haren, C. J. van Oel, and R. S. Kahn. "Quantitative Genetic Modeling of Variation in Human Brain Morphology." *Cerebral Cortex* 11, no. 9 (SEP, 2001): 816-824.

- Behrmann, M. and G. Avidan. "Congenital Prosopagnosia: Face-Blind from Birth." *Trends in Cognitive Sciences* 9, no. 4 (APR, 2005): 180-187.
- Behrmann, Marlene, Galia Avidan, Fuqiang Gao, and Sandra Black. "Structural Imaging Reveals Anatomical Alterations in Inferotemporal Cortex in Congenital Prosopagnosia." *Cerebral Cortex* 17, no. 10 (OCT, 2007): 2354-2363.
- Belin, P., S. Fecteau, and C. Bedard. "Thinking the Voice: Neural Correlates of Voice Perception." *Trends in Cognitive Sciences* 8, no. 3 (MAR, 2004): 129-135.
- Bodamer J. 1947. Die Prosop-Agnosie. *Arch Psychiatr Nervenkr* 179:6-53.
- Bowles, Devin C., Elinor McKone, Amy Dawel, Bradley Duchaine, Romina Palermo, Laura Schmalzl, Davide Rivolta, C. Ellie Wilson, and Galit Yovel. "Diagnosing Prosopagnosia: Effects of Ageing, Sex, and Participant-Stimulus Ethnic Match on the Cambridge Face Memory Test and Cambridge Face Perception Test." *Cognitive Neuropsychology* 26, no. 5 (2009): 423-455.
- Bruce, V. and A. Young. "Understanding Face Recognition." *British Journal of Psychology* 77, (AUG, 1986): 305-327.
- Chartrand, Jean-Pierre, Isabelle Peretz, and Pascal Belin. "Auditory Recognition Expertise and Domain Specificity." *Brain Research* 1220, (JUL 18, 2008): 191-198.
- Chiang, Ming-Chang, Katie L. McMahon, Greig I. de Zubicaray, Nicholas G. Martin, Ian Hickie, Arthur W. Toga, Margaret J. Wright, and Paul M. Thompson. "Genetics of White Matter Development: A DTI Study of 705 Twins and their Siblings Aged 12 to 29." *NeuroImage* 54, no. 3 (FEB 1, 2011): 2308-2317.
- Cohen, J. D. and F. Tong. "Neuroscience - the Face of Controversy." *Science* 293, no. 5539 (SEP 28, 2001): 2405-2407.
- Crookes, Kate and Elinor McKone. "Early Maturity of Face Recognition: No Childhood Development of Holistic Processing, Novel Face Encoding, Or Face-Space." *Cognition* 111, no. 2 (MAY, 2009): 219-247.
- Deffke I (2005) Untersuchung von Gesichterpriming und Lokalisation dipolarer Quellorte der Gesichtsverarbeitung in Magneto- und Elektroenzephalogramm. *Doctoral Thesis Berlin* 2005.
- De Haan, E. H. F. "A Familial Factor in the Development of Face Recognition Deficits." *Journal of Clinical and Experimental Neuropsychology* 21, no. 3 (JUN, 1999): 312-315.
- Della Sala S, Young AW. 2003. Quagliano's 1867 case of prosopagnosia. *Cortex* 39:533-400.
- Dinkelacker V, Grüter M, Klaver P, Grüter T, Specht K, Weis S, Kennerknecht I, Elger CE, Fernández G. Congenital prosopagnosia: Multistage anatomical and functional deficits in face processing circuitry. *J Neurol* 258: 770-782.
- Downing, P. E., Y. H. Jiang, M. Shuman, and N. Kanwisher. "A Cortical Area Selective for Visual Processing of the Human Body." *Science* 293, no. 5539 (SEP 28, 2001): 2470-2473.
- Dyer, A. G., C. Neumeyer, and L. Chittka. "Honeybee (*Apis Mellifera*) Vision can Discriminate between and Recognise Images of Human Faces." *Journal of Experimental Biology* 208, no. 24 (DEC, 2005): 4709-4714.
- Egger, G., G. N. Liang, A. Aparicio, and P. A. Jones. "Epigenetics in Human Disease and Prospects for Epigenetic Therapy." *Nature* 429, no. 6990 (MAY 27, 2004): 457-463.
- Eimer, M. and A. Holmes. "An ERP Study on the Time Course of Emotional Face Processing." *Neuroreport* 13, no. 4 (MAR 25, 2002): 427-431.

- Fagiolini, Michela, Catherine L. Jensen, and Frances A. Champagne. "Epigenetic Influences on Brain Development and Plasticity." *Current Opinion in Neurobiology* 19, no. 2 (APR, 2009): 207-212.
- Farroni, T., G. Csibra, G. Simion, and M. H. Johnson. "Eye Contact Detection in Humans from Birth." *Proceedings of the National Academy of Sciences of the United States of America* 99, no. 14 (JUL 9, 2002): 9602-9605.
- Galaburda, A. M. and B. C. Duchaine. "Developmental Disorders of Vision." *Neurologic Clinics* 21, no. 3 (AUG, 2003): 687-+.
- Gangestad, Steven W., Randy Thornhill, and Christine E. Garver-Apgar. "Men's Facial Masculinity Predicts Changes in their Female Partners' Sexual Interests Across the Ovulatory Cycle, Whereas Men's Intelligence does Not." *Evolution and Human Behavior* 31, no. 6 (NOV, 2010): 412-424.
- Gauthier, I., P. Skudlarski, J. C. Gore, and A. W. Anderson. "Expertise for Cars and Birds Recruits Brain Areas Involved in Face Recognition." *Nature Neuroscience* 3, no. 2 (FEB, 2000): 191-197.
- Gauthier, Isabel and Cindy Bukach. "Should we Reject the Expertise Hypothesis?" *Cognition* 103, no. 2 (MAY, 2007): 322-330.
- Garrido, Lucia, Nicholas Furl, Bogdan Draganski, Nikolaus Weiskopf, John Stevens, Geoffrey Chern-Yee Tan, Jon Driver, Ray J. Dolan, and Bradley Duchaine. "Voxel-Based Morphometry Reveals Reduced Grey Matter Volume in the Temporal Cortex of Developmental Prosopagnosics." *Brain* 132, (DEC, 2009): 3443-3455.
- Gehring, W. J. "New Perspectives on Eye Development and the Evolution of Eyes and Photoreceptors." *Journal of Heredity* 96, no. 3 (MAY, 2005): 171-184.
- Gehring, W. J. and K. Ikeo. "Pax 6 - Mastering Eye Morphogenesis and Eye Evolution." *Trends in Genetics* 15, no. 9 (SEP, 1999): 371-377.
- Gorlin, Robert J., Cohen Jr., M. Michael, Hennekam, Raul C. M. (2001). *Syndromes of the Head and Neck* (Oxford Monographs on Medical Genetics) Oxford University press, 4th edition 2001.
- Grueter, Martina, Thomas Grueter, Vaughan Bell, Juergen Horst, Wolfgang Laskowski, Karl Sperling, Peter W. Halligan, Hadyn D. Ellis, and Ingo Kennerknecht. "Hereditary Prosopagnosia: The First Case Series." *Cortex* 43, no. 6 (AUG, 2007): 734-749.
- Haider, N. B., A. Ikeda, J. K. Naggert, and P. M. Nishina. "Genetic Modifiers of Vision and Hearing." *Human Molecular Genetics* 11, no. 10 (MAY 15, 2002): 1195-1206.
- Halder, G., P. Callaerts, and W. J. Gehring. "Induction of Ectopic Eyes by Targeted Expression of the Eyeless Gene in Drosophila." *Science* 267, no. 5205 (MAR 24, 1995): 1788-1792.
- Haworth, C. M. A., M. J. Wright, M. Luciano, N. G. Martin, E. J. C. de Geus, C. E. M. van Beijsterveldt, M. Bartels, et al. "The Heritability of General Cognitive Ability Increases Linearly from Childhood to Young Adulthood." *Molecular Psychiatry* 15, no. 11 (NOV, 2010): 1112-1120.
- Haxby, J. V., L. Petit, L. G. Ungerleider, and S. M. Courtney. "Distinguishing the Functional Roles of Multiple Regions in Distributed Neural Systems for Visual Working Memory." *NeuroImage* 11, no. 5 (MAY, 2000): 380-391.
- Haxby, J. V., M. I. Gobbini, M. L. Furey, A. Ishai, J. L. Schouten, and P. Pietrini. "Distributed and Overlapping Representations of Faces and Objects in Ventral Temporal Cortex." *Science* 293, no. 5539 (SEP 28, 2001): 2425-2430.

- Haxby, J. V. and M. I. Gobbini. "Human Neural Systems for Face Perception and Social Communication." *International Journal of Psychophysiology* 45, no. 1-2 (JUL, 2002): 56-57.
- Hay D.C., Young A.W. (1982) The human face. In: Normality and pathology in cognitive functions. Eds.: A.W. Ellis, pp. 173-202, academic Press (1982).
- Herlitz, A. and J. E. Yonker. "Sex Differences in Episodic Memory: The Influence of Intelligence." *Journal of Clinical and Experimental Neuropsychology* 24, no. 1 (2002): 107-114.
- Hoffman (1998). Visual intelligence. W.W. Norton & Company, Inc., New York.
- Hoffman, E. A. and J. V. Haxby. "Distinct Representations of Eye Gaze and Identity in the Distributed Human Neural System for Face Perception." *Nature Neuroscience* 3, no. 1 (JAN, 2000): 80-84.
- Huang, Hao. "Structure of the Fetal Brain: What we are Learning from Diffusion Tensor Imaging." *Neuroscientist* 16, no. 6 (DEC, 2010): 634-649.
- Hulshoff-Pol, Hilleke E., Hugo G. Schnack, Danielle Posthuma, Rene C. W. Mandl, Wim F. Baare, Clarine van Oel, Neeltje E. van Haren, et al. "Genetic Contributions to Human Brain Morphology and Intelligence." *Journal of Neuroscience* 26, no. 40 (OCT 4, 2006): 10235-10242.
- Joshi, Anand A., Natasha Lepore, Shantanu H. Joshi, Agatha D. Lee, Marina Barysheva, Jason L. Stein, Katie L. McMahon, et al. "The Contribution of Genes to Cortical Thickness and Volume." *Neuroreport* 22, no. 3 (FEB 16, 2011): 101-105.
- Kanwisher, N. "Domain Specificity in Face Perception." *Nature Neuroscience* 3, no. 8 (AUG, 2000): 759-763.
- Kaschube, M., F. Wolf, T. Geisel, and S. Lowel. "Genetic Influence on Quantitative Features of Neocortical Architecture." *Journal of Neuroscience* 22, no. 16 (AUG 15, 2002): 7206-7217.
- Kendrick, K. M., A. P. da Costa, A. E. Leigh, M. R. Hinton, and J. W. Peirce. "Sheep Don't Forget a Face." *Nature* 414, no. 6860 (NOV 8, 2001): 165-166.
- Kennerknecht, Ingo, Thomas Grueter, Brigitte Welling, Sebastian Wentzek, Juergen Horst, Steve Edwards, and Martina Grueter. "First Report of Prevalence of Non-Syndromic Hereditary Prosopagnosia (HPA)." *American Journal of Medical Genetics Part a* 140A, no. 15 (AUG 1, 2006): 1617-1622.
- Kennerknecht, Ingo, Nga Yee Ho, and Virginia C. N. Wong. "Prevalence of Hereditary Prosopagnosia (HPA) in Hong Kong Chinese Population." *American Journal of Medical Genetics Part a* 146A, no. 22 (NOV 15, 2008): 2863-2870.
- Kennerknecht, Ingo, Nina Pluempe, Steve Edwards, and Rajiva Raman. "Hereditary Prosopagnosia (HPA): The First Report Outside the Caucasian Population." *Journal of Human Genetics* 52, no. 3 (MAR, 2007): 230-236.
- Kennerknecht, Ingo, Nina Pluempe, and Brigitte Welling. "Congenital Prosopagnosia - a Common Hereditary Cognitive Dysfunction in Humans." *Frontiers in Bioscience* 13, (JAN 1, 2008): 3150-3158.
- Kischka, Claudia (2011) Intrafamiliäre Variabilität der Gesichtserkennung [Intrafamilial variability of face recognition] , *Doctoral Thesis*, Münster 2011.
- Lee, Yunjo, Bradley Duchaine, Hugh R. Wilson, and Ken Nakayama. "Three Cases of Developmental Prosopagnosia from One Family: Detailed Neuropsychological and

- Psychophysical Investigation of Face Processing." *Cortex* 46, no. 8 (SEP 10, 2010): 949-964.
- Le Grand, R., C. J. Mondloch, D. Maurer, and H. P. Brent. "Expert Face Processing Requires Visual Input to the Right Hemisphere during Infancy." *Nature Neuroscience* 6, no. 10 (OCT, 2003): 1108-1112.
- Le Grand, Richard, Philip A. Cooper, Catherine J. Mondloch, Terri L. Lewis, Noam Sagiv, Beatrice de Gelder, and Daphne Maurer. "What Aspects of Face Processing are Impaired in Developmental Prosopagnosia?" *Brain and Cognition* 61, no. 2 (JUL, 2006): 139-158.
- Lenroot, Rhoshel K. and Jay N. Giedd. "Sex Differences in the Adolescent Brain." *Brain and Cognition* 72, no. 1 (FEB, 2010): 46-55.
- Lenroot, Rhoshel K., James E. Schmitt, Sarah J. Ordaz, Gregory L. Wallace, Michael C. Neale, Jason P. Lerch, Kenneth S. Kendler, Alan C. Evans, and Jay N. Giedd. "Differences in Genetic and Environmental Influences on the Human Cerebral Cortex Associated with Development during Childhood and Adolescence." *Human Brain Mapping* 30, no. 1 (JAN, 2009): 163-174.
- Liu, J., A. Harris, and N. Kanwisher. "Stages of Processing in Face Perception: An MEG Study." *Nature Neuroscience* 5, no. 9 (SEP, 2002): 910-916.
- Lokmane, Ludmilla and Sonia Garel. "Screening for Genes that Wire the Cerebral Cortex." *Bmc Biology* 9, (JAN 7, 2011): 1.
- Luo, Liqun, Edward M. Callaway, and Karel Svoboda. "Genetic Dissection of Neural Circuits." *Neuron* 57, no. 5 (MAR 13, 2008): 634-660.
- Mayr E, What evolution is, Basic Books New York 2001, p 76.
- McConachie, H. R. "Developmental Prosopagnosia - Single Case-Report." *Cortex* 12, no. 1 (1976): 76-82.
- McKone, Elinor and Romina Palermo. "A Strong Role for Nature in Face Recognition." *Proceedings of the National Academy of Sciences of the United States of America* 107, no. 11 (MAR 16, 2010): 4795-4796.
- McKone, Elinor and Rachel Robbins. "The Evidence Rejects the Expertise Hypothesis: Reply to Gauthier & Bukach." *Cognition* 103, no. 2 (MAY, 2007): 331-336.
- Milo, R., S. Shen-Orr, S. Itzkovitz, N. Kashtan, D. Chklovskii, and U. Alon. "Network Motifs: Simple Building Blocks of Complex Networks." *Science* 298, no. 5594 (OCT 25, 2002): 824-827.
- Minnebusch, Denise A., Boris Suchan, Meike Ramon, and Irene Daum. "Event-Related Potentials Reflect Heterogeneity of Developmental Prosopagnosia." *European Journal of Neuroscience* 25, no. 7 (APR, 2007): 2234-2247.
- Öhman, A. "Psychology - Conditioned Fear of a Face: A Prelude to Ethnic Enmity?" *Science* 309, no. 5735 (JUL 29, 2005): 711-+.
- Online Mendelian Inheritance in Man, OMIM (TM). McKusick-Nathans Institute of Genetic Medicine, Johns Hopkins University (Baltimore, MD) and National Center for Biotechnology Information, National Library of Medicine (Bethesda, MD), {20.3.2011}. World Wide Web URL: <http://www.ncbi.nlm.nih.gov/omim/>
- Park, Joonkoo, Lee I. Newman, and Thad A. Polk. "Face Processing: The Interplay of Nature and Nurture." *Neuroscientist* 15, no. 5 (OCT, 2009): 445-449.
- Pascalis, Olivier and David J. Kelly. "The Origins of Face Processing in Humans: Phylogeny and Ontogeny." *Perspectives on Psychological Science* 4, no. 2 (MAR, 2009): 200-209.

- Pfefferbaum, A., E. V. Sullivan, and D. Carmelli. "Genetic Regulation of Regional Microstructure of the Corpus Callosum in Late Life." *Neuroreport* 12, no. 8 (JUN 13, 2001): 1677-1681.
- Pakkenberg, B. and H. J. G. Gundersen. "Neocortical Neuron Number in Humans: Effect of Sex and Age." *Journal of Comparative Neurology* 384, no. 2 (JUL 28, 1997): 312-320.
- Polk, Thad A., Joonkoo Park, Mason R. Smith, and Denise C. Park. "Nature Versus Nurture in Ventral Visual Cortex: A Functional Magnetic Resonance Imaging Study of Twins." *Journal of Neuroscience* 27, no. 51 (DEC 19, 2007): 13921-13925.
- Quiroga, R. Q., L. Reddy, G. Kreiman, C. Koch, and I. Fried. "Invariant Visual Representation by Single Neurons in the Human Brain." *Nature* 435, no. 7045 (JUN 23, 2005): 1102-1107.
- Rehman, J. and A. Herlitz. "Higher Face Recognition Ability in Girls: Magnified by Own-Sex Own-Ethnicity Bias." *Memory* 14, no. 3 (APR, 2006): 289-296.
- Rhodes, Matthew G. "Age Estimation of Faces: A Review." *Applied Cognitive Psychology* 23, no. 1 (JAN, 2009): 1-12.
- Robbins, Rachel and Elinor McKone. "No Face-Like Processing for Objects-of-Expertise in Three Behavioural Tasks." *Cognition* 103, no. 1 (APR, 2007): 34-79.
- Russell, Richard, Brad Duchaine, and Ken Nakayama. "Super-Recognizers: People with Extraordinary Face Recognition Ability." *Psychonomic Bulletin & Review* 16, no. 2 (APR, 2009): 252-257.
- Schmalzl, Laura, Romina Palermo, and Max Coltheart. "Cognitive Heterogeneity in Genetically Based Prosopagnosia: A Family Study." *Journal of Neuropsychology* 2, (MAR, 2008): 99-117.
- Schmitt, J. E., R. K. Lenroot, G. L. Wallace, S. Ordaz, K. N. Taylor, N. Kabani, D. Greenstein, et al. "Identification of Genetically Mediated Cortical Networks: A Multivariate Study of Pediatric Twins and Siblings." *Cerebral Cortex* 18, no. 8 (AUG, 2008): 1737-1747.
- Schwarzer, Gudrun, Susanne Huber, Martina Grueter, Thomas Grueter, Cornelia Gross, Melanie Hipfel, and Ingo Kennerknecht. "Gaze Behaviour in Hereditary Prosopagnosia." *Psychological Research-Psychologische Forschung* 71, no. 5 (SEP, 2007): 583-590.
- Steeves, Jennifer, Laurence Dricot, Herbert C. Goltz, Bettina Sorger, Judith Peters, A. David Milner, Melvyn A. Goodale, Rainer Goebel, and Bruno Rossion. "Abnormal Face Identity Coding in the Middle Fusiform Gyrus of Two Brain-Damaged Prosopagnosic Patients." *Neuropsychologia* 47, no. 12 (OCT, 2009): 2584-2592.
- Sinha, Pawan, Benjamin Balas, Yuri Ostrovsky, and Richard Russell. "Face Recognition by Humans: Nineteen Results all Computer Vision Researchers should Know about." *Proceedings of the IEEE* 94, no. 11 (NOV, 2006): 1948-1962.
- Stiles, Joan and Terry L. Jernigan. "The Basics of Brain Development." *Neuropsychology Review* 20, no. 4 (DEC, 2010): 327-348.
- Stollhoff, Rainer, Juergen Jost, Tobias Elze, and Ingo Kennerknecht. "Deficits in Long-Term Recognition Memory Reveal Dissociated Subtypes in Congenital Prosopagnosia." *Plos One* 6, no. 1 (JAN 25, 2011a): e15702.
- Stollhoff, Rainer, Juergen Jost, Tobias Elze, and Ingo Kennerknecht. "The Early Time Course of Compensatory Face Processing in Congenital Prosopagnosia." *Plos One* 5, no. 7 (JUL 21, 2010): e11482.

- Stollhoff, Rainer, Ingo Kennerknecht, Tobias Elze, and Jürgen Jost. "A Computational Model of Dysfunctional Facial Encoding in Congenital Prosopagnosia." *Neural Networks : The Official Journal of the International Neural Network Society* 24, no. 6 (Aug, 2011b): 652-664.
- Tibbetts, E. A. and J. Dale. "A Socially Enforced Signal of Quality in a Paper Wasp." *Nature* 432, no. 7014 (NOV 11, 2004): 218-222.
- Tropea, Daniela, Audra Van Wart, and Mriganka Sur. "Molecular Mechanisms of Experience-Dependent Plasticity in Visual Cortex." *Philosophical Transactions of the Royal Society B-Biological Sciences* 364, no. 1515 (FEB 12, 2009): 341-355.
- Tsao, Doris Y. and Margaret S. Livingstone. "Mechanisms of Face Perception." *Annual Review of Neuroscience* 31, (2008): 411-437.
- van Heyningen, V. and K. A. Williamson. "PAX6 in Sensory Development." *Human Molecular Genetics* 11, no. 10 (MAY 15, 2002): 1161-1167.
- Wang, Lupeng, Rashmi Sarnaik, Krsna Rangarajan, Xiaorong Liu, and Jianhua Cang. "Visual Receptive Field Properties of Neurons in the Superficial Superior Colliculus of the Mouse." *Journal of Neuroscience* 30, no. 49 (DEC 8, 2010): 16573-16584.
- Wilmer, Jeremy B., Laura Germine, Christopher F. Chabris, Garga Chatterjee, Mark Williams, Eric Loken, Ken Nakayama, and Bradley Duchaine. "Human Face Recognition Ability is Specific and Highly Heritable." *Proceedings of the National Academy of Sciences of the United States of America* 107, no. 11 (MAR 16, 2010): 5238-5241.
- Yovel, G. and N. Kanwisher. "Face Perception: Domain Specific, Not Process Specific." *Neuron* 44, no. 5 (DEC 2, 2004): 889-898.
- Zhang, Feng, Alexander M. Aravanis, Antoine Adamantidis, Luis de Lecea, and Karl Deisseroth. "Circuit-Breakers: Optical Technologies for Probing Neural Signals and Systems." *Nature Reviews Neuroscience* 8, no. 8 (AUG, 2007): 577-581.
- Zhang, Xiaozheng and Yongsheng Gao. "Face Recognition Across Pose: A Review." *Pattern Recognition* 42, no. 11 (NOV, 2009): 2876-2896.
- Zhu, Qi, Yiyang Song, Siyuan Hu, Xiaobai Li, Moqian Tian, Zonglei Zhen, Qi Dong, Nancy Kanwisher, and Jia Liu. "Heritability of the Specific Cognitive Ability of Face Perception." *Current Biology* 20, no. 2 (JAN 26, 2010): 137-142.

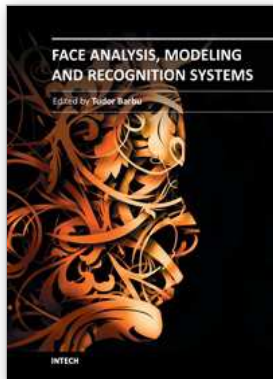

Face Analysis, Modeling and Recognition Systems

Edited by Dr. Tudor Barbu

ISBN 978-953-307-738-3

Hard cover, 212 pages

Publisher InTech

Published online 30, September, 2011

Published in print edition September, 2011

The purpose of this book, entitled Face Analysis, Modeling and Recognition Systems is to provide a concise and comprehensive coverage of artificial face recognition domain across four major areas of interest: biometrics, robotics, image databases and cognitive models. Our book aims to provide the reader with current state-of-the-art in these domains. The book is composed of 12 chapters which are grouped in four sections. The chapters in this book describe numerous novel face analysis techniques and approach many unsolved issues. The authors who contributed to this book work as professors and researchers at important institutions across the globe, and are recognized experts in the scientific fields approached here. The topics in this book cover a wide range of issues related to face analysis and here are offered many solutions to open issues. We anticipate that this book will be of special interest to researchers and academics interested in computer vision, biometrics, image processing, pattern recognition and medical diagnosis.

How to reference

In order to correctly reference this scholarly work, feel free to copy and paste the following:

Ingo Kennerknecht, Claudia Kischka, Claudia Stemper, Tobias Elze and Rainer Stollhoff (2011). Heritability of Face Recognition, Face Analysis, Modeling and Recognition Systems, Dr. Tudor Barbu (Ed.), ISBN: 978-953-307-738-3, InTech, Available from: <http://www.intechopen.com/books/face-analysis-modeling-and-recognition-systems/heritability-of-face-recognition>

INTECH

open science | open minds

InTech Europe

University Campus STeP Ri
Slavka Krautzeka 83/A
51000 Rijeka, Croatia
Phone: +385 (51) 770 447
Fax: +385 (51) 686 166
www.intechopen.com

InTech China

Unit 405, Office Block, Hotel Equatorial Shanghai
No.65, Yan An Road (West), Shanghai, 200040, China
中国上海市延安西路65号上海国际贵都大饭店办公楼405单元
Phone: +86-21-62489820
Fax: +86-21-62489821

© 2011 The Author(s). Licensee IntechOpen. This chapter is distributed under the terms of the [Creative Commons Attribution-NonCommercial-ShareAlike-3.0 License](#), which permits use, distribution and reproduction for non-commercial purposes, provided the original is properly cited and derivative works building on this content are distributed under the same license.