

Artificial Intelligent Based Friction Modelling and Compensation in Motion Control System

Tijani Ismaila B., Rini Akmeliawati and Momoh Jimoh E. Salami
*Intelligent Mechatronics Systems Research Unit,
Department of Mechatronics Engineering,
International Islamic University Malaysia
Kuala Lumpur,
Malaysia*

1. Introduction

The interest in the study of friction in control engineering has been driven by the need for precise motion control in most of industrial applications such as machine tools, robot systems, semiconductor manufacturing systems and Mechatronics systems. Friction has been experimentally shown to be a major factor in performance degradation in various control tasks. Among the prominent effects of friction in motion control are: steady state error to a reference command, slow response, periodic process of sticking and sliding (stick-slip) motion, as well as periodic oscillations about a reference point known as hunting when an integral control is employed in the control scheme. Table 1 shows the effects and type of friction as highlighted by Armstrong et. al. (1994). It is observed that, each of task is dominated by at least one friction effect ranging from stiction, or/and kinetic to negative friction (Stribeck). Hence, the need for accurate compensation of friction has become important in high precision motion control. Several techniques to alleviate the effects of friction have been reported in the literature (Dupont and Armstrong, 1993; Wahyudi, 2003; Tjahjowidodo, 2004; Canudas, et.al., 1986).

One of the successful methods is the well-known model-based friction compensation (Armstrong et al., 1994; Canudas de Wit et al., 1995 and Wen-Fang, 2007). In this method, the effect of the friction is cancelled by applying additional control signal which generates a torque/force. The generated torque/force has the same value (or approximately the same) with the friction torque/force but in opposite direction. This method requires a precise modeling of the characteristics of the friction to provide a good performance. Hence, in the context of model-based friction compensation, identification of the friction is one of the important issues to achieve high performance motion control.

However, as discussed in the literatures, several types of friction models have been identified (Armstrong et al., 1994; Canudas et. al., 1995; Makkar et. al., 2005) and classified as static or dynamic friction models. Among the static models are Coulomb friction model, Tustin model, Leuven model, Karnop model, Lorentzian model. Meanwhile Dahl model, LuGre model, Seven parameters model, and the most recent Generalized Maxwell-Slip (GMS) model, are among the dynamic friction models (Tjahjowidodo, 2004). The static friction model is simple and easy in the identification process, however using such model

Tasks	Friction Effects	Dominant Friction
Regulator (pointing/position control)	Steady-state error, hunting	Stiction
Tracking with velocity reversal	Standstill, and lost of motion	Stiction
Tracking at low velocity	Stick-slip	Stribeck friction, stiction
Tracking at high velocity	Large tracking error	Viscous behavior of lubricant

Table 1. Control tasks and associated friction effects

for friction compensation usually lead to poor performance especially at very low velocity control.

On the other hand, the accuracy of the dynamic friction model is anchored on the dependency of friction on immeasurable internal states such as velocity and position. Since friction model selection is an essential factor in the model-based friction compensation, it is important to find an appropriate friction model that will effectively alleviate the frictional effects in motion control applications. This has been the basis for the continuous search for more efficient and simple model for friction identification and compensation in motion control system.

The recent development in Artificial Intelligent (AI) makes it adaptable for system modeling base on the data training and expert knowledge. It has been shown that the major AI paradigms (Neural Network, Fuzzy Logic, Support vector machine etc.) have the capability of approximating any nonlinear functions to a reasonable degree of accuracy; and hence, have been identified and proposed as appropriate alternatives for friction model and compensation in motion control systems, (Bi et.al., 2004; Kemal and Masayoshi, 2007; Wahyudi and Ismaila, 2008). In addition, the use of artificial intelligence based friction model may also reduce both the complexity and time consumed in the friction modeling and identification.

This chapter first presents an overview of model-based friction techniques which have been used in friction modeling and compensation in motion control systems. Then the application of artificial intelligent based methods in this area is reviewed. The development, implementation and performance comparison of Adaptive Neuro-Fuzzy inference system (ANFIS) and Support Vector Regression (SVR) for non-linear friction estimation in a motion control system so as to achieve high precision performance are described. These two AI techniques are selected based on their unique characteristics over others as discussed latter in this paper. A comparative study on the performance of these two AI techniques in terms of modeling accuracy, compensation efficiency, and computational time is examined. The chapter is concluded with highlights of summary of the results of the study and future directions of research in this area.

2. Review of friction modelling techniques in motion control system

The study of friction is dated back to the work of Leonardo da Vinci (1452-1519) who investigated the nature of friction and proposed the basis for the theory of classical friction. According to da Vinci (1452-1519) theory of friction, and latter work of Amontons (1699), and Charles (1785) friction is proportional to load, opposed motion, and is independent of

contact area. With the birth of tribology and its recent advancement, details about the topography of contact between bodies especially at atomic level have been more detailed and investigated by Armstrong (1991) and recently revisited by Farid (2008).

Two main regimes have been identified for friction, namely: pre-sliding and sliding. Pre-sliding regime defines friction at very low velocity prior to sliding motion and is a function of displacement, while sliding regime covers the period when the body is sliding/in motion and during this period friction is a function of velocity of motion. Some of the challenges in friction model includes the merging of friction model in both regimes in order to offer a smooth transition from pre-sliding to sliding regime which takes into consideration frictional effects such as: Stribeck, stick-slip, hysteresis, break-away force, nonlocal memory, and friction lag. For motion control applications, friction study is been carried out to compensate its negative effects on control performances.

Several methods have been adopted for friction compensation in the research domain and industry. Detailed review was given by Armstrong (1994). Non-model-based compensation includes the use of stiff proportional-derivative (PD) control, integral control with deadband, dither, impulsive control and joint torque control and nonlinear controllers. Stiff PD approach involves the use of either high derivative (velocity) feedback or high proportional position feedback. This has been shown to be effective for stable tracking and for system designed for high rigidity.

The use of integral control to eliminate the steady state error due to friction is confronted with the problem of limit cycles. This necessitates the introduction of deadband at the input of the integrator control block, thereby limiting the attainable steady state accuracy (Shen and Wang, 1964).

Dither is a high frequency signal added to the control signal to eliminate the effects of the nonlinearities which include friction in the system. The application of dither in aerospace control was reported by Oppelt (1976). The challenges in application of dither lies in its mode of generation and application.

Others form of non-model based techniques include impulsive control, joint torque (Armstrong, 1992; Hashimoto et al., 1992).

The use of nonlinear controllers has also been reported by many researchers. PD controller plus a discontinuous nonlinear proportional feedback (DNPF) was proposed by Southward et al., (1991), while PD plus smooth robust nonlinear feedback (SRNF) was investigated by Cai and Song (1993). A compensation scheme using nominal characteristic trajectory following (NCTF) was presented by Wahyudi et al., (2005) and this has been reported to outperform both the DNPF and SRNF techniques.

The concept of model-based friction compensation is depicted in Figure 1, where the friction signal \hat{u}_f is approximately equal to the actual plant friction u_f , that is $\hat{u}_f = u_f$; u_c is control signal generated by the linear controller G_c ; u_{in} is actual input control signal into the plant; θ_r is reference position signal; θ_{out} is output position response of the system; $\dot{\theta}$ is velocity signal; G_c is a linear controller designed with nominal plant model; G_1 is sub-system model 1 and G_2 is sub-system model 2.

Though very simple, the effectiveness of the technique is anchored on the precision of the friction model and the velocity estimation. It is implemented as either feedforward model-based when the desired reference velocity is taken as the input to the model, or feedback model-based when the input velocity is estimated from the sensed output. Both methods of implementation have been adopted by different authors as reported by Armstrong (1994).

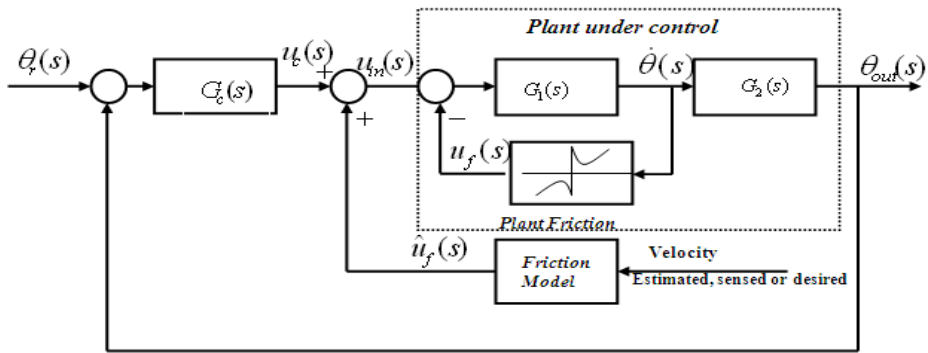

Fig. 1. Block diagram of basic model-based friction compensation**

2.1 Parametric based friction models

Coulomb friction is the earliest physical model of friction based on the work of Da Vinci (1519), Amontons (1699) and Coulomb (1785). It is described as a constant opposing force independent of velocity of motion and is mathematically given by

$$F_f = F_c \operatorname{sgn}(\dot{\theta}) \quad (1)$$

and illustrated by Figure by Figure 2a

The viscous friction was developed by Reynold (1866) followed the birth of the theory of hydrodynamics. Viscous friction is proportional to velocity, and it is zero when velocity goes to zero

$$F_f = F_\theta \dot{\theta} \quad (2)$$

This led to the well known combine Coulomb plus viscous static model shown in Figure 2 (b), and represented by

$$F_f = F_c \operatorname{sgn}(\dot{\theta}) + F_\theta \dot{\theta} \quad (3)$$

This model has been widely applied in control system due to its simplicity. It has been experimentally proven to be efficient for application above certain minimum velocity (Armstrong, 1991). Canudas et al. (1986) employed Coulomb and viscous model in an adaptive model-based friction compensation and has reported an improved performance in terms of positioning accuracy. Based on its historical place in friction modeling, it is often used for benchmarking the performance of other more complex models (Tjahjowidodo, 2004; Wahyudi and Tijani, 2008). The major problems with this model have been the failure to account for friction at zero velocity and other several friction behaviors especially at low velocity.

Morin (1833) introduced the idea of friction at rest known as stiction or static friction. Stiction friction is defined as the force (torque) requires to initiate motion from rest, and is generally greater than the Coulomb (Kinetic) friction. Friction was then seen to depend not only on velocity but magnitude and rate of the external force. This resulted in a complete

model of static friction as shown in Figure 2(c). However, Stribeck (1902) observed a decreasing friction with increasing velocity at low velocity during the transition from stiction to kinetic friction and he proposed the concept of Stribeck friction shown in Figure 2(d). In order to overcome the jump discontinuity of the model at zero velocity, a modification was introduced (Karnopp, 1985) by replacing the jump with a line of finite slope as shown in Figure 2(e). A combination of stiction, Stribeck, Coulomb and viscous friction model is been referred to as Stribeck friction (Armstrong, 1991) or General Kinetic Friction (GKF), (Evangelos et.al, 2002), and is described by

$$F_f = \begin{cases} F_f(\dot{\theta}) & \dot{\theta}(t) \neq 0, \ddot{\theta} = 0 \\ F_e & \dot{\theta}(t) = 0, \ddot{\theta} = 0, |F_e| < F_s \\ F_s \operatorname{sgn}(F_e) & \dot{\theta}(t) = 0, \ddot{\theta} \neq 0, |F_e| > F_s \end{cases} \quad (4)$$

Several variant of Stribeck friction has been reported and evaluated by Armstrong (1991). A general exponential form is given by

$$F_f(\dot{\theta}) = \left[F_c + (F_s - F_c) \exp(-|\dot{\theta}/\dot{\theta}_s|^\delta) \right] \operatorname{sgn}(\dot{\theta}) + F_\delta \dot{\theta} \quad (5)$$

where $F_f, F_s, F_c,$ and F_δ are the friction force, stiction, kinetic and viscous frictions respectively, $\dot{\theta}$ is the velocity of motion, $\dot{\theta}_s$ is the Stribeck velocity, constant δ is an empirical parameter that determines the shape of the model, in which $\operatorname{sgn}(\dot{\theta})$ is defined as

$$\operatorname{sgn}(\dot{\theta}) = \begin{cases} +1 & \dot{\theta}(t) > 0 \\ 0 & \dot{\theta}(t) = 0 \\ -1 & \dot{\theta}(t) < 0 \end{cases} \quad (6)$$

where values of $\delta=1$ and $\delta=2$ indicate the Tustin /exponential model (1947) and Gaussian model respectively.

Hess and Soom (1990) proposed another model of the form

$$F_f(\dot{\theta}) = \left[F_c + \frac{F_s - F_c}{1 + (\dot{\theta}/\dot{\theta}_s)^2} \right] \operatorname{sgn}(\dot{\theta}) + F_\delta \dot{\theta} \quad (7)$$

which is known as Lorentzian friction model.

Tustin (1947) was the first to make use of a negative viscous friction (stribeck) in the analysis of feedback control. Armstrong (1991) employed exponential, gaussian, Lorentzian together with a polynomial model given by

$$F_f(\dot{\theta}) = F_c + F_2 \dot{\theta}^2 + F_3 \dot{\theta}^3 + F_4 \dot{\theta}^4 + F_5 \dot{\theta}^5 + F_6 \dot{\theta}^6 + F_7 \dot{\theta}^7 + F_\delta \dot{\theta}^8 \quad (8)$$

for friction identification in a robot arm system. The Lorentzian model gave best performance fit and was later adopted for the friction compensation.

Several other researchers have employed the complete stribeck model both for fixed and adaptive model-based friction compensation (Envangelos, et.al., 2002; and Lorinc and Bela,

2007). Improved performance with respect to tracking and steady state accuracy have been reported by them. A continuous, differentiable friction model with six parameters was recently proposed by Makkar et al., (2005). The performance of the model was evaluated with numbers of simulations and found to account for major friction effects such as Coulomb, viscous, and stiction. Its experimental implementation for friction compensation has not yet been reported.

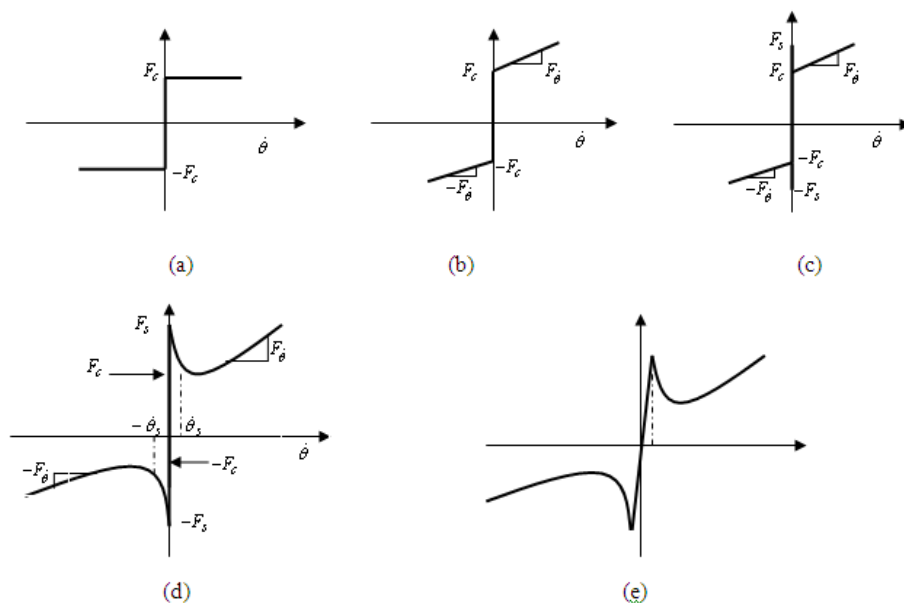

Fig. 2. Static friction models (a) Coulomb friction, (b) Coulomb + Viscous friction (c) Stiction + Coulomb + Viscous friction (d) Stiction + Stribeck + Coulomb + Viscous and (e) Modified Stribeck friction (Karnopp Model)

Though the General Kinetic Friction (GKF) fails to account for pre-sliding friction behaviors and other dynamics characteristics such as friction lag and local memory hysteresis, experimental works have proven that a good static friction model can approximate the real friction force with a degree of confidentiality of 90% (Armstrong, 1991; Lorinc and Bela, 2007). Also, Canudas de Wit et al., (1995) demonstrated that the simulated static friction model and dynamic friction model predicts almost the same limit cycles generated by friction in controlled positioning system. Hence, static friction model-based compensation and identification techniques still have great significant practical applications.

Dynamic friction models have been proposed to account for various pre-sliding friction behaviors and these are becoming essentials for higher precision performance at micro- and nano- scale velocity and positioning control (Yi et. al., 2008). Some of the common dynamic models which have been considered in control applications are Dahl, LuGre, Leuven, and Generalized Maxwell-Slip (GMS). Dahl model (1968) was the first simple dynamic model proposed for simulations of control system with friction. This was used for adaptive friction compensation by Ehrich (1991) and is expressed as

$$\frac{dF}{dx} = \sigma \left(1 - \frac{F}{F_c} \operatorname{sgn}(\dot{\theta}) \right)^\alpha \quad (9)$$

where F is the friction as a function of displacement x , F_c is the Coulomb friction, $\dot{\theta}$ is the motion velocity and α is empirical parameter which determines the shapes of the model. It is position dependent model which captures the hysteresis behavior of friction but fails to account for stiction and Stribeck.

Another dynamic model was proposed and implemented by Canudas de Wit et al. (1995). In addition, Canudas de wit et al. (1995) modified the Dahl model to incorporate breakaway (stiction) friction and its dynamics together with Stribeck effect using exponential GFK to give what is been referred to as LuGre friction. This model captures most of the experimentally observed friction characteristics, and is the first dynamic model that seeks to effect smooth transition between the two friction regimes without recourse to switching function. It is mathematically given by

$$\frac{dz}{dt} = \dot{\theta} - \sigma_o \frac{|\dot{\theta}|}{g(\dot{\theta})} z, \quad (10)$$

$$F_t = \sigma_o z + \sigma_1(\dot{\theta}) \frac{dz}{dt} + F_{\dot{\theta}}(\dot{\theta}) \quad (11)$$

where z is average of bristle deflection, F_t is the tangential friction force, $g(\dot{\theta})$ is stribeck friction for steady-state velocities, $F_{\dot{\theta}}$ is viscous friction coefficient, while σ_o and σ_1 are dynamic parameters, which are respectively the frictional stiffness and frictional damping. LuGre model has been employed for friction analysis and compensation in various control systems (Wen-Fang, 2007).

However, LuGre model fails to capture the non-local memory effect of hysteresis. Leuven model proposed by Swevers et. al., (2000) is an elaborate model than LuGre as it incorporating hysteresis function with non-local memory behavior in pre-sliding regime. Apart from its complexity that has rendered it less effective in control system application, Lampaert et. al., (2002) pointed out two major problems associated with Leuven model namely: discontinuity and memory stack algorithm.

GMS is a qualitative new formulation by Lampaert et.al. (2003) based on the rate-state approach of the LuGre and the Leuven models. It is noteworthy that despite the unique advantages of dynamic models, one of the major challenges associated with their practical implementation is the dependency of the models on unmeasurable internal state of the system and/or availability of very high resolution of (order 10^{-6}) sensing devices (Armstrong, 1991). Hence, many of the reported works employing complex dynamic friction model are based on simulation study.

2.2 Non-parametric based techniques

Due to the complexity and difficulty associated with physical models of friction in terms of model selection, parameters estimation, and implementation, non-parametric based approach using Artificial Intelligent (AI) approach is been alternatively employed in control systems for friction identification and compensation. Neural network (NN), fuzzy logic

(FL)/adaptive neuro-fuzzy inference system (ANFIS), support vector machine (SVM), and genetic algorithm are among the common AI methods that have been reportedly used in positioning control system.

The theory of artificial neural network (ANN) is based on simulated nerve cells or neuron which are joined together in a variety of ways to form network. The main feature of the ANN is that it has the ability to learn effectively from the data, and has been identified as a universal function approximator (Haykin, 1999). ANN with back propagation was proposed by (Kemal M. Ciliza and Masaypshi Tomizukab, 2007; Wahyudi and Tijani, 2008) for friction modeling and compensation with varying structures and applications. The performance of classical friction model was compared with Multilayer Feedforward Network (MFN)-based friction model for friction compensation in (Wahyudi and Tijani, 2008), and MFN was reported to outperform the classical friction model. A hybrid ANN was developed by Kemal and Masayoshi (2007) where static and adaptive parametric models are combined with ANN to better capture the discontinuities at the zero velocity. A radial basis function (RBF) approach was proposed in (Du and Nair, 1999; and Haung et al., 2000) where the center points and variances of the Gaussian functions had to be chosen a priori. Gan and Danai (2000) developed model-based neural network (MBNN), and structured according to linearized state space model of the plant and incorporated into LuGre friction model in a Linear Motor stage.

Despite the extensive use of ANN for friction modelling, no ANN structure has been agreed upon for optimal friction modeling for a varieties of motion control systems. There is need to extend the notion of MBNN for other friction models that are suitable for some motion control systems. Some of the challenges associated with the use of ANN in friction modeling include: selection of appropriate structures (layers, neurons, and models) for a particular application, generalization and local minimal problems.

Though ANFIS has been applied in nonlinear system modeling and control (Stefan, 2000), its application in friction modeling and compensation in motion control has not received much attention in the literatures. ANFIS is a Tagaki Sugeno (TSK) based fuzzy inference system implemented in the framework of adaptive networks (Jang 1995). It has the ability to construct an input-output mapping based on both human knowledge (in the form of fuzzy if-then rules) and stipulated input-output data pairs. Existing work related to the use of Neuro-Fuzzy can be found in many areas such as velocity control in (Jun and Pyeong, 2000), (Chorng-Shyan 2003). In the latter case, fuzzy inference system was introduced to compensate for friction parameter variations. Recently Tijani et.al (2011) reported the application of ANFIS in friction modelling and compensation in motion control system. Their results confirmed that this technique produces better performance in friction modelling than parametric methods.

Application of Support Vector Regression (SVR) in adaptive friction compensation was recently proposed (Wang et al., 2007, Ismaila et.al. 2009(b)). It is noted that SVR has not been extensively explored as compared to ANN for friction modelling. Also, other forms of SVR such as least square support vector regression regression (LS-SVR) has been proposed as alternative to SVR with a more simplified optimization algorithm (Johan, Van Gestel, De Brabanter and Vandewalle, 2002), however it is yet to be employed in friction identification. In addition, GA was employed for the estimation of optimal parameters for LuGre parametric models by De-peng (2005), while hybrid of ANN and Gafor friction modelling has been reported in (Sung-Kwun et al., 2006).

3. System modelling and identification

Development of an appropriate mathematical model is the first step in order to characterize friction associated with motion control system. Figure 2 shows the experimental set-up of a DC motor-driven rotary motion system which consists of servo motor driven by an amplifier and position encoder attached to the shaft as the feedback sensor. The input to the motor is the armature voltage u driven by a voltage source. The measurable variable is the angular position of the shaft, θ in radian, while the angular velocity of the motor shaft ($\dot{\theta}$ in radian/s) is estimated using an appropriate digital filter. The plant was integrated into MATLAB xPC target environment as shown in Figure 3 for real-time experimental implementation.

Basically, in line with model-based friction compensation approach, the system can be decomposed into nominal (linear model) and non-linear sub-systems as shown in Figure 4. The nominal/linear sub-system is obtained from the physics of the system based on first principle approach and system identification process for linear parameters estimation (Tijani et.al,2009). The nonlinear sub-system on the other hand, represents the friction present in the system. The friction occurs between various moving parts in the system. For instance, it exists between the motor shaft and bearing, encoder shaft, external shaft, load and associated bearing. As stated in section 2.1, the friction can take different form depending on the geometry of the system and operating conditions. In this study, major sliding friction effects dominating the sliding motion regime are considered. This consists of stiction, Stribeck, and coulomb friction as shown in Figure 2e. Note that the viscous friction is regarded as included in linear sub-system model and its detailed derivation is reported in (Tijani, 2009). The resulting second order mathematical model is given as

$$G(s) = \frac{\theta(s)}{u(s)} = \frac{K}{s(\tau_p s + 1)} \quad (12)$$

where $K = 275$ and $\tau_p = 0.1009$

3.1 Friction identification experiments

Generally, in supervised AI-based modelling the availability of representative data is very important. Two major experiments are required to obtain the velocity to friction relationship for both break-away friction force and Stribeck friction. The major hardware, apart from the Host and Target PC, are the National Instrument (NI) Multifunction input-output (I/O) data acquisition (DAQ) PCI6024E, with BNC-2110 adapter for data acquisition to and from the Target PC. A Scancon incremental shaft encoder with resolution of 2×10^{-4} (in quadrature mode) was used for measuring the position in radian. A current sensor with 0-5Amp current rating which is above the maximum current rating of the motor, 2Amp. was used for measuring the armature current. A simple experiment based on Ohm's Law was carried out to test and model the V-I relationship of the sensor prior to the performance of the experiment. This is required to transform the output voltage of the current sensor to corresponding current.

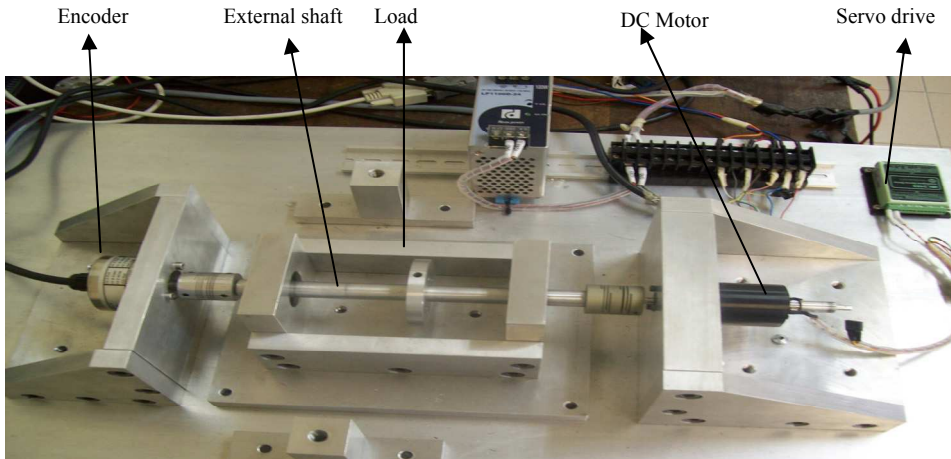

Fig. 2. DC-Motor driven rotary motion systems.

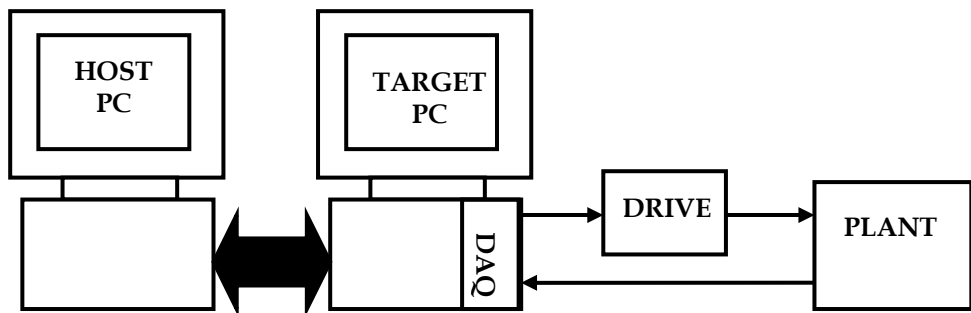

Fig. 3. MALAB xPC target set-up.

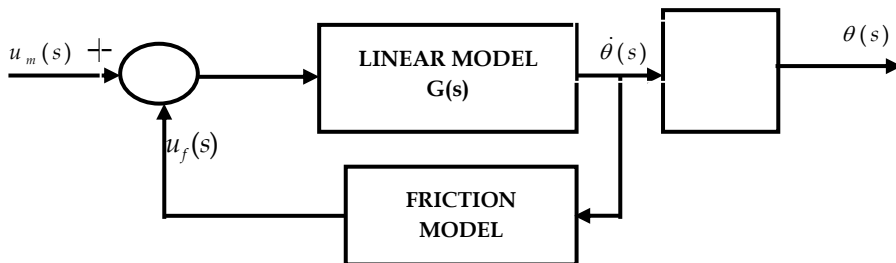

Fig. 4. Complete system model.

The resulting voltage-to-current relationship is given by

$$I_s = 7.8555V_s - 19.6544 \tag{13}$$

where V_s is sensor output in volts and I_s is equivalent current sensor output in amperes.

The first experiment tagged break-away experiment is to yield the break-away friction force (τ_f) in an open-loop mode. The break-away force is the force requires to initiate motion, in other word it represents the stiction friction at zero velocity, i.e. the $\tau_f(\dot{\theta})\big|_{\dot{\theta}=0}$. The systematic steps followed according to (Armstrong, 1991) are:

- “Warming-Up” of the Plant at beginning of each run
- Gradual Increase of the motor Current at steps of 0.001volts command signal in pen loop mode until the shaft moves (or breaks-away), this was taken to be at least 2 encoder counts.
- Repetition of steps 1-2 for several times and Averaging of results in order to guarantee repeatability

The procedures were repeated for both positive and negative directions of motion with 10 time runs for different days with a ramp input. The mean of the resulting values measured by the current sensor in volts is then computed to give the average stiction friction force 2.531volt and 2.475volt for poistive and negative direction of motion respectively. The difference between the friction force values in the poistive and negative directions of motion justifies the asymmetric nature of friction.

The second experiment involves identification of steady-state velocity-friction relationship. The direct relationship between the friction torque, τ_f and motor torque τ_m at steady state (i.e when $\dot{\theta} \approx 0$) is explored in this experiment. At steady state, $\tau_f = \tau_m$, and since τ_m is proportional to the armature current i_a , it follows that τ_f is propotional to i_a . The experiemnt is conducted for a closed-loop system with an appropriate velocity controller. Though any linear controller can be employed, a stiff velocity control scheme such as the pseudo-derivative feedback with feedforward (PDF) (Ohm,1990) has been shown to give better performance especially at low-velocity control regime (Tijani, 2009). A suitable velocity region is selected for both directions of motion to cover the low and high speed above the region of Stribeck effect. For each constant velocity within this region, the average of armature current and steady state velocity are then computed after the transient period of 0.2 second. Five different runs were carried out for each velocity input, and the overall mean is computed. A total of 108 data sets were obtained for each direction of motion. Figure 5 and Figure 6 show samples of the steady state responses of the plant for positive and negative directions respectively. Finally, the friction data acquired in voltage form based on the output of the current sensor is transformed into actual armature current using the V-I relationship in (13). The complete experimental data set for both directions are shown in Figure 7.

4. Artificial intelligent based friction modelling and compensation

The development of Artificial Intelligent (AI) based friction modelling and application of such model in friction compensation in motion control is described in this section. The objective is to demonstrate the suitability of AI techniques in friction compensation in motion control system. Though there exists several AI methods that can be applied based on their approximating capability, the focus in this section is on the ANFIS and SVR based on their unique characteristics over other AI methods.

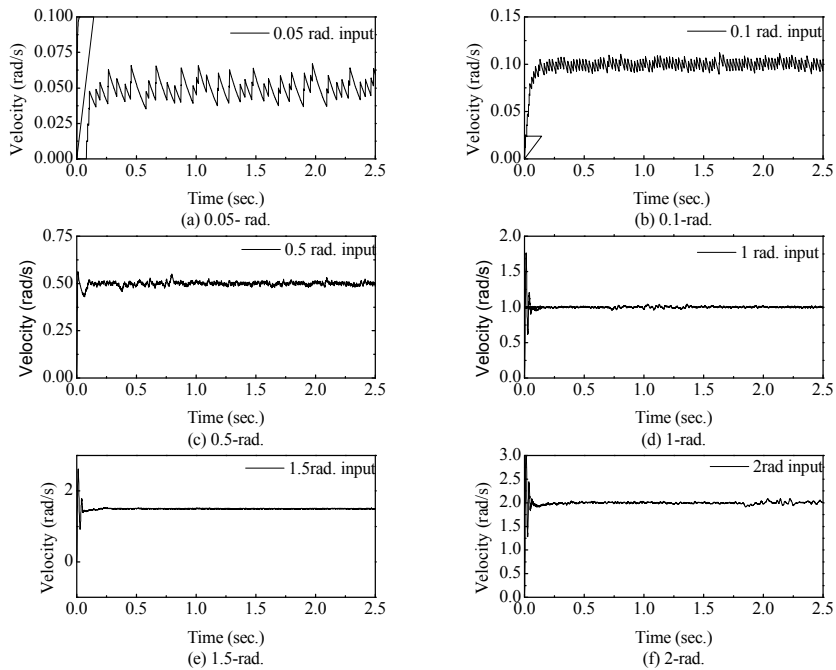

Fig. 5. Samples of positive steady-state velocity responses.

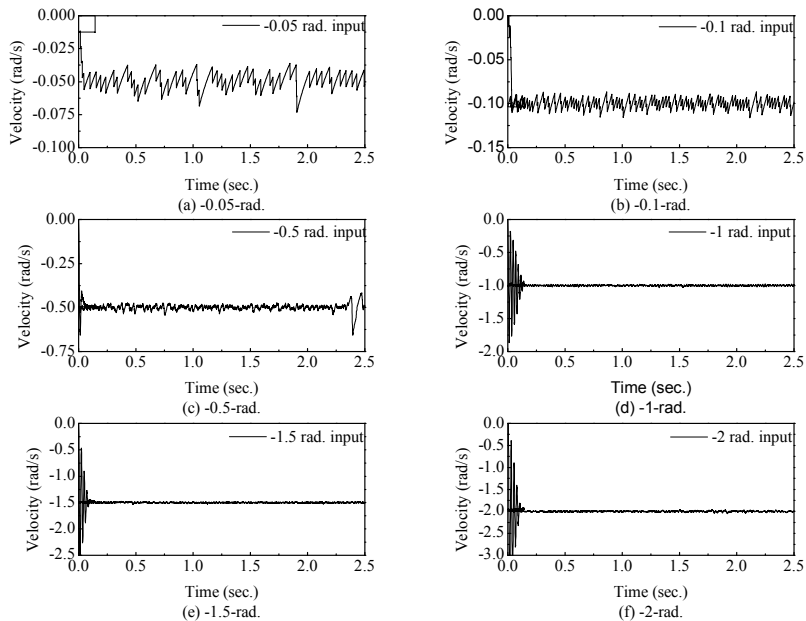

Fig. 6. Samples of negative steady-state velocity responses.

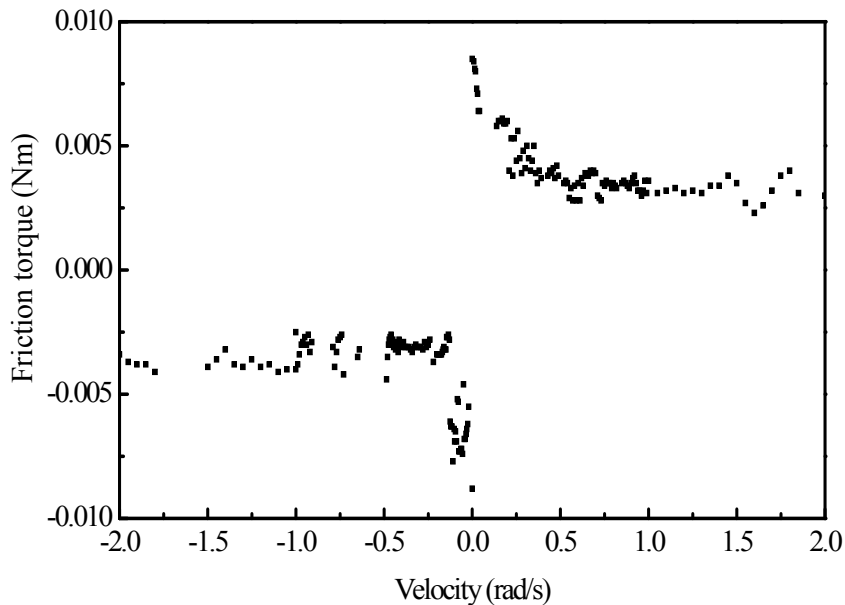

Fig. 7. Complete experimental friction-velocity data set for both positive and negative direction.

4.1 ANFIS and SVR as modeling tools

Both ANFIS and SVR are characterized with unique qualities that make them effective for nonlinear system identification and modeling. ANFIS is a hybrid AI-paradigm, integrating the best features of Fuzzy System (based on expert knowledge) and Neural Networks (based on data mining) in solving the problems of transforming the expert knowledge into fuzzy rules and tuning of membership functions associated with ordinary fuzzy inference system. On the other hand, SVR is an extension of the well developed theories of Support vector machine (SVM) to regression problems with introduction of ε -insensitivity loss function by Vapnik (1995). Unlike traditional learning algorithm for function estimation such as Neural network that minimizes the error on the training data based on the principle of Empirical risk minimization, SVR embodies the principle of structure risk minimization which minimizes an upper bound on the expected risk. Hence, it is characterized by better ability to generalize, and at the same time it is less prone to the problems of overfitting and local minimal. Though initially developed for linear function estimation, the principle of linear SVR was extended to non-linear case by the application of the kernel trick. Due to these unique advantages, SVR has been recently employed for non-linear function approximation and system modeling (Bi et al 2004, Ahmed et al 2008). A brief theoretical overview of the two paradigms are given here while full detail can be obtained in the literatures (Jang, 1993, Tijani et al., 2011). It should be noted that there are two techniques of SVR namely ε -SVR and ν -SVR. The first is based on original concept of ε -insensitivity Vapnik (1995), and it involves the selection of appropriate ε -parameter for the modelling process. The challenges associated with the selection of ε is overcome by the use of ν -SVR in

which a parameter v is introduced to facilitate the optimal computation of ε -sensitivity function. Tijani (2009) reported a comparison of these two techniques. v -SVR was reported with both better modelling and compensation accuracy of friction in motion control system. Hence, only the v -SVR is reported in this chapter while the reader is referred to the literature for detailed review of the other two approaches

4.1.1 ANFIS overview

Basically, ANFIS implements Takagi Sugeno Fuzzy Inference System, and consists of five layers minus the input layer O as shown in Figure 8. Besides the input layer O, each other layer performs a specific function based on the associated node function as follows:

Layer 1 is responsible for the fuzzification of the input signal X_1 and X_2 with appropriate membership function. It consists of adaptive nodes in which the parameters of membership function are adjusted during learning process.

Layer 2 compute the firing strength ω_i of each rule using a T-norm (min, product, etc) of the incoming signals.

Layer 3 estimate the normalized firing strength, ϖ_i of each fuzzy rule

Layer 4 also consists of adaptive nodes for computing the consequence parameters Q_i .

Layer 5 compute the overall output, O using a linear combination of all the incoming signals from layer 4 :

Parametrically, ANFIS is represented by two parameter sets: the input/premise parameters and the output/ consequence parameters.

4.1.2 SVR overview

Given a set of N input/output data $\{x_i, y_i\}_{i=1}^N$ such that $x_i \in \mathfrak{R}^n$ and $y_i \in \mathfrak{R}$, the goal of v -SVR learning theory is to find a function f which minimizes the regularized risk function (structural risk function) of the form (Schölkopf and Smola, 2002):

$$R_{reg}^v[f] := R_{emp}[f] + \frac{1}{2} \|w\|^2 + v\varepsilon \quad (14)$$

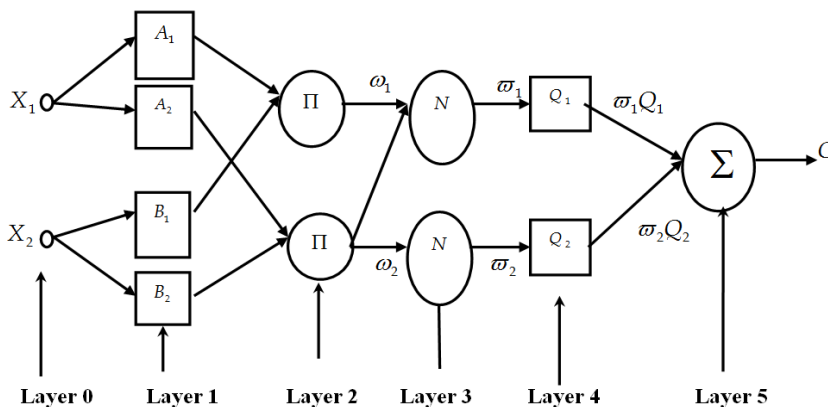

Fig. 8. Two inputs, one output typical ANFIS structure.

where $\frac{1}{2}\|w^2\|$ is the regularization term(or complexity penalizer) used to find the flattest function with sufficient approximation qualities, $R_{emp}[f]$ is an empiric risk defined as:

$$R_{emp}[f] := \frac{1}{N} \sum_{i=1}^N L(y_i, f(x_i)) \tag{15}$$

and parameter v is for automatic selection of optimal ϵ and control of number of SVs. For Vapnik's ϵ -insensitivity, the loss function is defined as :

$$L_\epsilon(y) = |y - f(x)|_\epsilon = \begin{cases} 0 & \text{if } |y - f(x)| \leq \epsilon \\ |y - f(x)| - \epsilon & \text{otherwise} \end{cases} \tag{16}$$

Methodologically, v -SVR processes are similar to that of ϵ -SVR . It involves formulation of the problem in the primal weight space as a constrained optimization problem by formulating the Lagrangian, then take the conditions for optimality, and finally solve the problem in the dual space of Lagrange multipliers called support values. Though, initially developed for linear function estimation, the principle of linear SVR was extended to non-linear case by the application of the kernel trick. For non-linear regression in the primal weight space the model is of the form

$$f(x) = \omega^T \varphi(x) + b \tag{17}$$

where for the given training set $\{x_i, y_i\}_{i=1}^N$, $\varphi(\cdot) : \mathfrak{R}^n \rightarrow \mathfrak{R}^{n_h}$ is a mapping to a high dimensional feature space by the application of the kernel trick which is defined as

$$K(x_i, x_j) = \varphi(x_i)^T \varphi(x_j) \tag{18}$$

The constraint optimization problem in the primal weight space is

$$\min_{\omega, b, \xi, \xi^*} J_P(\omega, \xi, \xi^*, \epsilon) = \frac{1}{2} \omega^T \omega + C \cdot \left(v\epsilon + \sum_{i=1}^N (\xi_i + \xi_i^*) \right)$$

Subject to:

$$\begin{aligned} y_i - \omega^T \varphi(x) - b &\leq \epsilon + \xi_i & i = 1, 2, \dots, N \\ \omega^T \varphi(x) + b - y_i &\leq \epsilon + \xi_i^* & i = 1, 2, \dots, N \text{ and } \xi_i, \xi_i^* \geq 0, \epsilon \geq 0 \end{aligned} \tag{19}$$

where ξ_i, ξ_i^* are the slack variables for soft margin

By defining the Lagrangian and applying the conditions for optimality solution, one obtains the following v -SVR dual optimization problem:

$$\max_{\alpha, \alpha^*} J_D(\alpha, \alpha^*) = -\frac{1}{2} \sum_{i,j=1}^N (\alpha_i - \alpha_i^*)(\alpha_j - \alpha_j^*) K(x_i, x_j) + \sum_{i=1}^N y_i (\alpha_i - \alpha_i^*)$$

Subject to: $\sum_{i=1}^N (\alpha_i - \alpha_i^*) = 0,$

$$0 \leq \alpha_i, \alpha_i^* \leq \frac{C}{N} \quad \forall i = 1, 2, \dots, N \quad \text{and} \quad \sum_i^N (\alpha_i^* + \alpha_i) \leq C.v \quad (20)$$

Thus, the regression estimate is given by

$$f(x) = \sum_{i=1}^N (\alpha_i + \alpha_i^*) K(x_i, x_j) + b \quad (21)$$

where α_i, α_i^* are the Lagrange multipliers which are the solution to the Quadratic optimization problem, and b follows from the complementary Karush-Kuhn-Tucker (KKT) conditions (Scholkopf and Smola, 2002).

From the foregoing review, it is clear that the choice of Kernel function and the optimization parameters to be selected a priori play important roles in overall performance of the regression process. As previously reported in (Scholkopf and Smola, 2002), the range $0 \leq v \leq 1$ has been identified as effective range of parameter v for control of errors, thereby simplifying the selection range of parameters combination as compared to ϵ -SVR.

4.2 Development of ANFIS friction model

The ANFIS-GP model was developed using MATLAB Fuzzy logic toolbox. First the data was partitioned into training (60) and validation (40) data sets, and based on prior information about the friction characteristics, two membership functions were assigned to the input while the value of the premise parameters were initially set to satisfy ϵ -completeness (Lee, 1990) with $\epsilon = 0.5$. The training was carried out using Hybrid training with 0.0001 error target and 100 epochs. Figure 9 shows the resulting model with Gaussian membership function.

4.3 Development of v -SVR friction model

The SVR-model was developed with reference to the original Matlab toolbox codes by Canu et al (2005). The overall procedures are as follows:

- Partitioning of data into training and validation sets.
- Selection of Kernel function: e.g. Gaussian kernel
- Selection and tuning of the regression parameters: σ -Kernel parameter ($0 \leq v \leq 1$), and C-Capacity control for optimum performance. Various combinations of these parameters were employed and cross-validated with testing data for both directions of motion.
- Computation of the difference of the Lagrange multipliers ($\alpha_i - \alpha_i^*$), support vectors (nsv), bias term, b and epsilon, ϵ .
- Computation of the SVR/decision functions.

The resulting SVR models with training data and associated support vectors (circled 'star data points') are shown in Figure 10 (a) and (b) for positive and negative directions respectively.

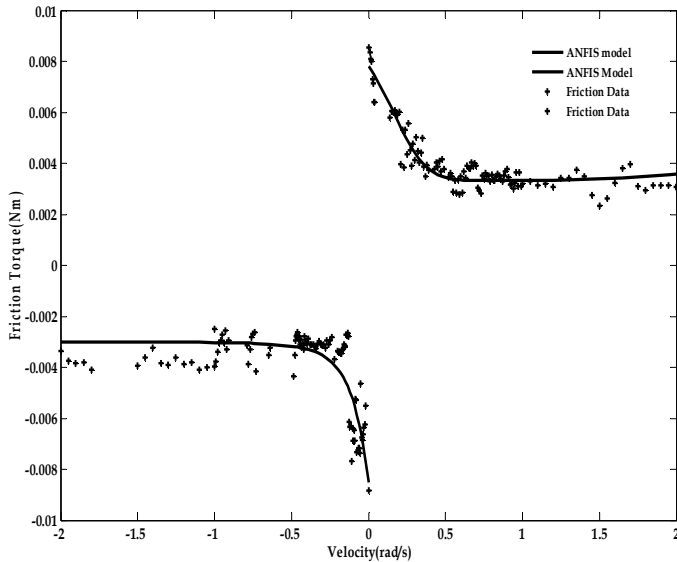

Fig. 9. ANFIS friction model with Gaussian membership function.

4.4 Friction compensation

The developed AI-based friction models are used in model-based friction compensation as shown in Figure 11. The linear PD controller using root-locus technique with nominal plant model given in equation (12). The use of PD controller is to enable proper evaluation of the friction model performance since the controller does not have an integral action that has the effect of suppressing the friction effect. The real-time scheme is implemented with the MATLAB xPc target. ANFIS is implemented with the inbuilt MATLAB Fuzzy-Simulink block while the resulting model parameters (difference of Lagrange multipliers and bias) of the v -SVR are integrated to an embedded Matlab function for online real-time friction compensation. Referring to Figure 11, the control law with friction compensation is given as:

$$u_c = u_{in} + \hat{u}_f \quad (22)$$

Hence it can be seen that if $\hat{u}_f(\dot{\theta}) \approx u_f(\dot{\theta})$ and the modeling error is approximately equal zero, the effect of friction force is effectively compensated and the position accuracy improved.

Figure 12 (a) and (b) show the the comparison of the response of the plant with and without both ANFIS and v -SVR friction compensators for 0.1 and 1 degree step inputs . The tracking errors for 0.1 and 1 degree for 1Hz sine wave input are shown in Figure 13 (a) and (b). These were repeated for 0.5 and 10 degrees step (both directions) and sine wave reference input, and the overall results are reported in Table 2 (a), (b) and Table 3 for point-to-point and tracking control respectively in terms of response time, steady state accuracy and root mean square error(RMSE).

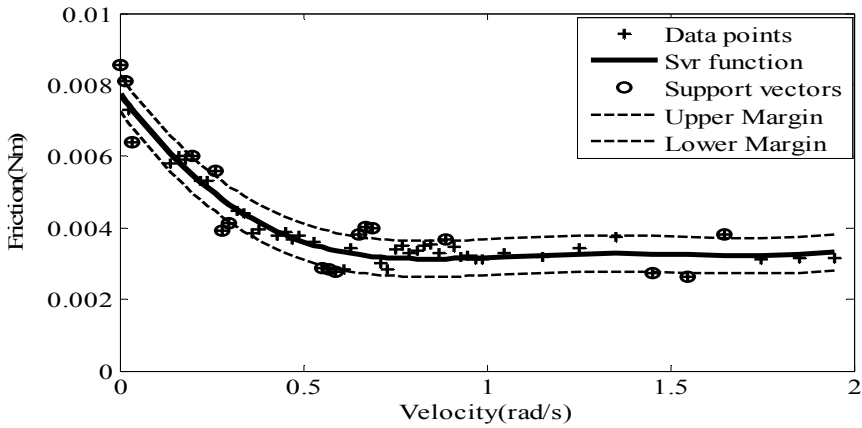

(a) Positive direction.

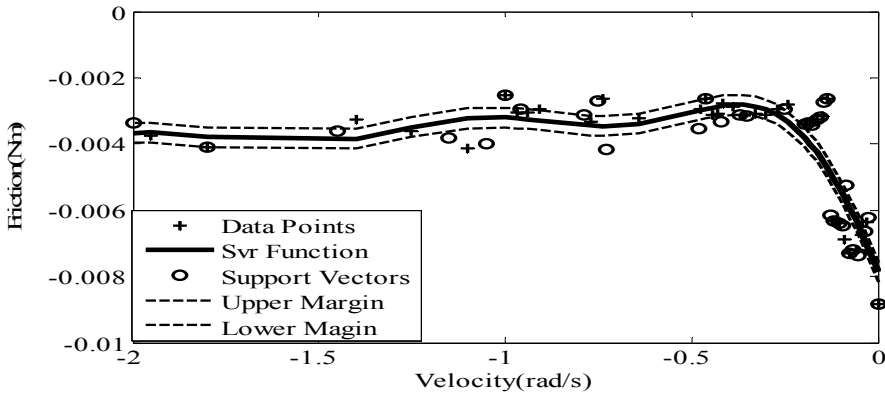

(b) Negative direction.

Fig. 10. v -SVR friction mod

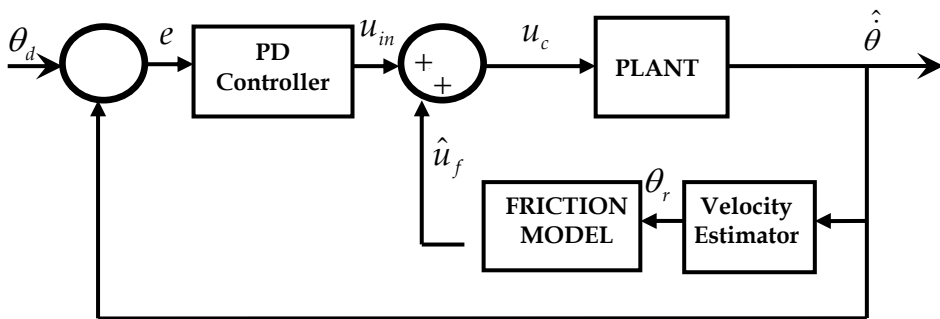

Fig. 11. Control scheme for the model-based friction compensation.

5. Performance comparison of the proposed AI-models

The performance comparison of the two proposed AI-based friction models is carried out in terms of modeling accuracy, compensation efficiency, and computational time/complexity. The modeling accuracy refers to the performance of the model on training and validation is data. Table 4 gives the comparison of the two models RMSE for both directions of motion. The percentage reduction in both steady state and tracking error for each ANFIS-based and v -SVR compensators was computed so as to compare their compensation efficiency as shown respectively in Figure 14(a) and (b) and Figure 15. Also, the computational time for training and prediction based on the MATLAB resources was computed to examine the complexity of each model as reported in Table 5.

6. Discussions

The performance improvements recorded with each of the friction compensators over only linear PD controller indicate the importance and requirements of friction compensation for precision positioning control especially at low reference input where the effect of negative friction is highly deteriorating. Comparatively, a better modeling accuracy and compensation efficiency were generally obtained with v -SVR as reported in Table 4, and shown in Figure 14 (a) and (b) and Figure 15. Significant reduction in positioning error over the use of only linear controller was observed in particular up to 90% reduction in steady state error and 60% reduction in root mean square error for PTP and tracking respectively with the v -SVR based friction compensators as against 90% and 50% reduction respectively with ANFIS model. On the other hand, with the MATLAB resources employed, ANFIS is less computational intensive with average computational time of 110ms per training while v -SVR takes 220ms per each iteration in modeling of friction as indicated in Table 5. It should be noted that, many iterative steps are required in SVR development as compared to ANFIS. However, ANFIS is noted to have lesser prediction response with slower time response of 1.6ms as compared to v -SVR with approximately 0.5ms. This implies a tradeoff between desired performance accuracy in favor of SVR and less computational efforts for model development in favor of ANFIS.

The general performance of SVR over ANFIS can be attributed to the fact that SVR algorithm minimizes an upper bound on the expected risk, that is, SVR not only minimizes the error on the training data as in ANFIS modeling but it also minimizes model complexity. So it was able to generalize better than ANFIS on the noisy real-time velocity data during the compensation especially for tracking control.

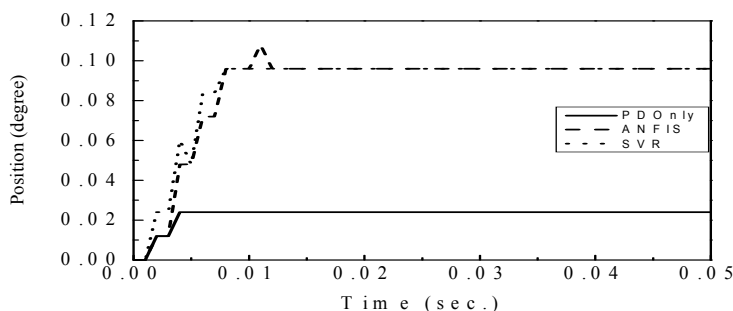

Fig. 12(a). 0.1 deg.

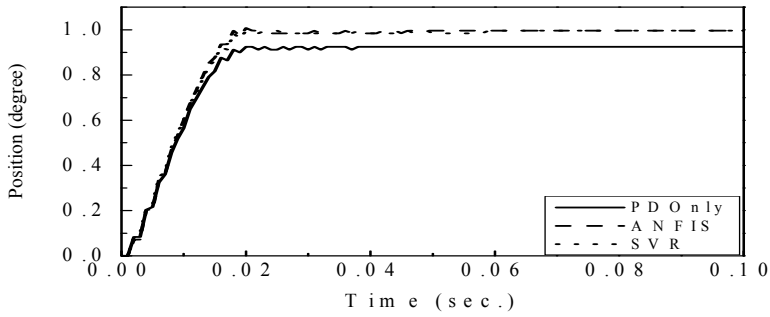
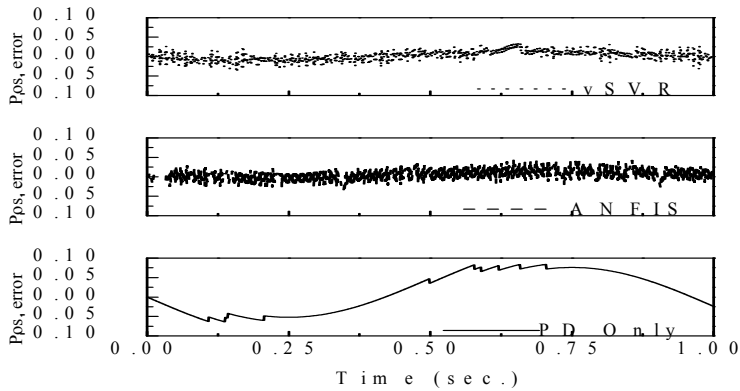
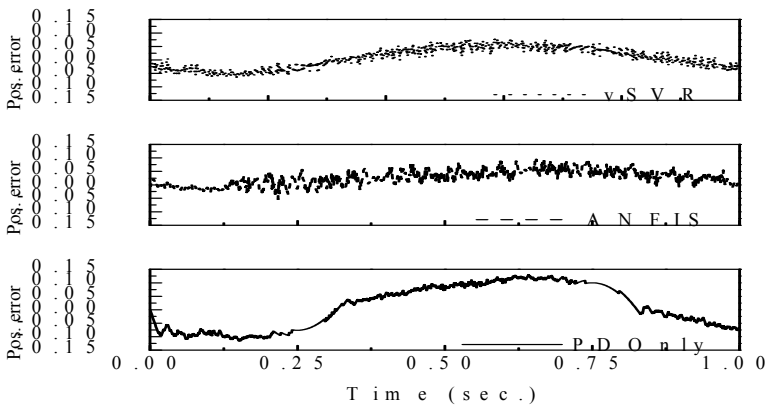

Fig. 12(b). 1.0 deg.

Fig. 12. Step input responses with and without the Friction compensator.



(a) 0.1-deg. Sine input.



(b) 1-deg. Sine input.

Fig. 13(a) and (b). Position tracking error for sinusoidal reference signal.

	POSITIVE STEP INPUTS							
	0.1-deg.		0.5-deg.		1-deg.		10-deg.	
Friction Compensators	ess(%)	Tr(sec.)	ess(%)	Tr(sec.)	ess(%)	Tr(sec.)	ess(%)	Tr(sec.)
No Compensator	75	N/A	37.6	N/A	7.6	0.017	1.8	0.015
ANFIS	4	0.0084	0.8	0.009	0.4	0.015	0.3	0.014
<i>v</i> -SVR	4	0.008	0.8	0.01	0.4	0.015	0.1	0.014

Table 2(a). Performance comparison results for positive PTP positioning control.

	NEGATIVE STEP INPUTS							
	-0.1-deg.		-0.5-deg.		-1-deg.		-10-deg.	
Friction Compensators	ess(%)	Tr(sec.)	ess(%)	Tr(sec.)	ess(%)	Tr(sec.)	ess(%)	Tr(sec.)
No Compensator	76	N/A	44.26	N/A	21	0.017	1.24	0.015
ANFIS	4	0.009	0.8	0.008	0.4	0.012	0.1	0.014
<i>v</i> -SVR	4	0.008	0.8	0.013	0.4	0.013	0.04	0.014

Table 2(b). Performance comparison results for negative PTP positioning control.

Friction Compensators	Root Mean Square Errors (RMSE)			
	0.1-deg.	0.5-deg	1-deg.	10-deg.
No Compensator	0.0355	0.0656	0.0874	0.0959
ANFIS	0.0165	0.0277	0.0380	0.0587
<i>v</i> -SVR	0.0132	0.0255	0.0390	0.0608

Table 3. Performance comparison results for tracking positioning control.

		Training RMSE	Prediction RMSE
ANFIS	Positive Direction	0.000458	0.000443
	Negative Direction	0.000725	0.000744
<i>v</i> -SVR	Positive Direction	0.000408	0.000430
	Negative Direction	0.000690	0.000727

Table 4. Performance comparison in terms of the modelling accuracy.

		Training Computational time(ms)	Prediction Computational time(ms)
ANFIS	Positive Direction	108.581	1.605
	Negative Direction	110.080	1.605
<i>v</i> -SVR	Positive Direction	209.692	0.493
	Negative Direction	224.828	0.493

Table 5. Performance comparison in terms of computational time.

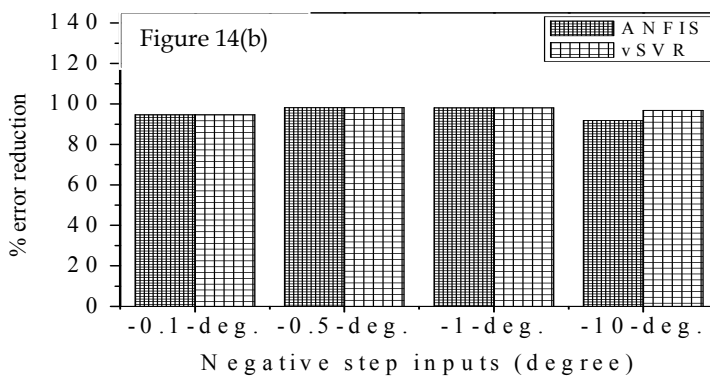
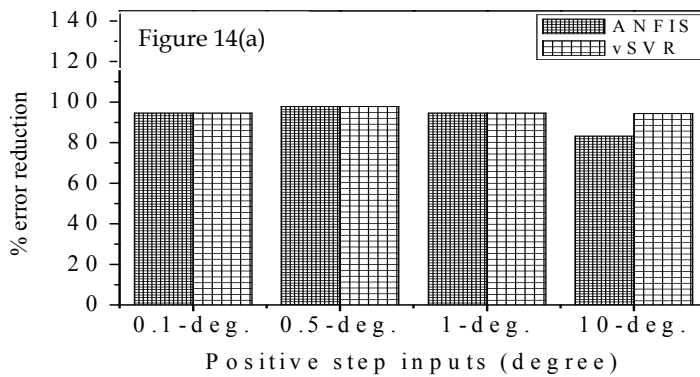

Fig. 14(a) and (b). Comparison of the ANFIS and v -SVR models in terms of %reduction in steady state error over only PD controller for step inputs

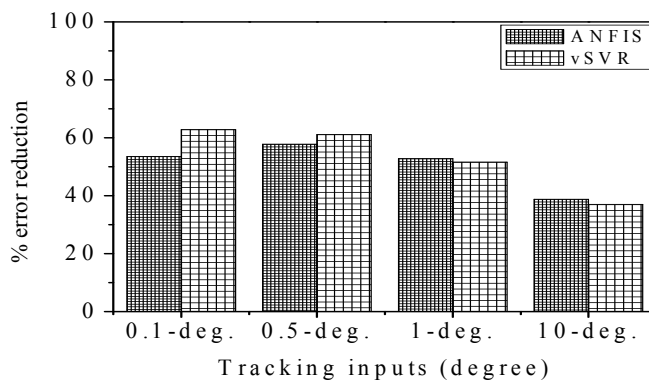

Fig. 15. Comparison of the ANFIS and v -SVR Models in terms %reduction in tracking error over Only PD controller for tracking control.

7. Conclusion

The application of artificial intelligent based techniques in friction modeling and compensation in motion control system has been presented in this chapter. The chapter focuses on comparative study of the two developed AI-friction models which have been carried out in terms of modeling accuracy, compensation efficiency, and computational time. In comparison, v -SVR outperforms ANFIS both in representing and compensating the frictional effects especially for tracking control at low velocity regime. The results show v -SVR to be better in representing friction than ANFIS with smaller RMSE for both training and prediction of friction. Though, both perform equally in PTP control, v -SVR outperformed ANFIS in tracking control with 60% to 50% reduction in tracking error. Computationally, ANFIS is better with smaller computational processes and time for modeling than SVR, but appears to be poor in prediction than SVR.

It is noted from this study that the performance of the friction model is greatly affected by the precision of the sensor employed. This has limited the minimum velocity that can be controlled to 0.1 degree. Apart from sensor effect, extension of these techniques to micro/nano scale positioning control will required the incorporation of dynamic friction model in the AI-friction model development.

Also, the velocity estimation from the position sensor used introduced noise in the feedback signal. This is responsible for non-smoothness in the tracking responses. This can be avoided either with the use of better position sensor together with more sophisticated velocity filter or by using separate sensor to measure the velocity directly.

8. References

- Ahmed G. Abo-Khalil and Dong-Choon Lee, (2008). *MPPT Control of Wind Generation Systems Based on Estimated Wind Speed Using SVR*, IEEE Transactions on Industrial Electronics, Vol.55, no. 3, March 2008.
- Amontons, G., (1699). *On the resistance originating in machines*, Proc. of the French Royal Academy of Sciences. pp. 206-22.
- Armstrong-Helouvry B., Dupont P. and De Wit C., (1994). *A survey of models, analysis tools and compensation method for the control of machines with friction*, Automatica, Vol. 30, No. 7 (1994) pp. 1083-1138.
- Armstrong-Helouvry B., (1992) *Control of Machines with Friction*, Boston, MA, Kluwer, 1991
- Bi.D, Y.F.Li, T.S.Tso, and G.L.Wang, (2004), *Friction modeling and Compensation for Haptic display based on Support Vector Machine*, IEEE Trans. Ind. Electron., vol. 51, no. 2, pp. 491-500, Apr.2004
- Cai L. and G. Song, (1993). *A smooth robust nonlinear controller for robot manipulators with joint stick-slip friction*, in Proceedings of IEEE Int. Conference on Robotics and Automation, Atlanta, 1993, pp.449-454.
- Canudas de Wit, K.J. Astrom and K. Braun, (1986). *Adaptive friction compensation in DC motor drives*, Proceeding of IEEE International Conference on Robotics and Automation, San Francisco, Vol. 3, pp. 1556-1561, 1986.
- Canudas de Wit, H. Olsson, K. J. Astrom, and P. Lischinsky, (1995). *A New Model for Control of Systems with Friction*, IEEE Transactions on Automatic Control, vol. 40, no. 3, pp. 419-425, 1995

- Canu S., Y.Grangyalet , V. Guigue,and A. Rakotomamonjy, (2005). *SVM and Kernel Methods Matlab Toolbox*. PerceptionSystemes et Information, INSA de Rouen, Rouen, France, 2005.
- Charles M. Close, Dean H. Frederick, and Jonathan C. Newell, (2002). *Modeling and analysis of dynamic systems*, John Wiley and Sons, Inc.
- Chorng-Shyan Lin, (2003). *Recurrent neuro-fuzzy modeling and fuzzy MD control for flexible servomechanisms*, Journal of Intelligent and Robotic Systems 38: 213–235, © 2003 Kluwer Academic Publishers, printed in the Netherlands.
- Coulomb, C. A. (1785). *Theorie des machines simples, enayant egard au frottemen de leurs parties, et a la roideur dewes cordages*”. Mem. Math Phys., x, 161-342.
- Da Vinci, L. (1519). *The Notebooks*, Dover, NY.
- Dahl P., (1968). *A solid friction model*, Technical Report TOR-0158H3107–181-1, the Aerospace Corporation, El Segundo, CA.
- De-Peng Liu, (2005). *Research on Parameter Identification of Friction Model for Servo Systems Based on Genetic Algorithms*, Proceedings of the 2005 Fourth International Conference on Machine Learning and Cybernetics, Guangzhou.
- Dupont P. and B. Armstrong-Helouvry, (1993). *Compensation techniques for servo with friction*, Proceeding of American Control Conference, San Francisco, Vol. 2, pp. 1915-1919, 1993.
- Ehrich, N. E., (1991). *An investigation of control strategies for friction compensation*. M.S. Thesis, Dept. of Electrical Engineering, University of Maryland, MA.
- Envangelos G., Papadopoulos and Georgios C. Chasparis,(2002). *Analysis and model based control of servomechanisms with friction*, Proc. of the International Conference on Intelligent Robots and Systems (IROS 2002),EPFL Lausanne, Switzerland.
- Farid Al-Bender and Jan Swevers, (2008). *Characterization of friction force dynamics*, IEEE Control Systems Magazine, vol. 28, no.6, pp. 64-81.
- Hashimoto, M., K. Koreyeda, T. Shimono, H. Tanaka, Y. Kiyosawa and H.Hirabayashi, (1992). *Experimental study on torque control using harmonic drive built-in torque sensors*, Proc. Inter. Conf on Robotics and Automation, IEEE,Nice, pp. 2026-2031.
- Haykin S. (1999), *Neural networks: a comprehensive foundation*, 2nd Ed., New Jersey, Prentice Hall.
- Jang J.S.R. (1993). *ANFIS: Adaptive-Network-Based Fuzzy Inference System*”, IEEE Trans. Systems, Man, Cybernetics,23 (5/6):665-685, 1993.
- Jang J.S.R and N. Gulley, Natick, MA ,(1995). *“The Fuzzy Logic Toolbox for use with MATLAB”*: The MathWorks Inc., 1995
- Johan A.K. Suykens, Van Gestel T., De Brabanter J., De Moor B., Vandewalle J., (2002). *Least squares support vector machines*, River Edge, NJ: World Scientific.
- Jun Oh Jang and Pyeong Gi Le,(2000). *Neuro-fuzzy control for dc motor friction compensation*, Proceedings of the 39th IEEE Conference on Decision and Control Sydney, Australia.
- Ismaila B. Tijani, Wahyudi M. and Talib H.H., (2011). *Adaptive Neuro-Fuzzy Inference System (ANFIS) for Friction Modeling and Compensation in Motion Control Syste*, International Journal of Modeling and Simulation, Volume 31, No. 1,2011, ACTA PRESS.
- Ismaila B. Tijani, Wahyudi M. and Talib H.H., (2009). *A Non-Parametric Friction Model for Accurate Positioning Control using v-Support Vector Regression (v-SVR)*, Proc. of the 2009 IEEE/ASME International Conference on Advanced Intelligent Mechatronics

will be held on July 14-17, 2009 in Suntec International Convention and Exhibition Center, Singapore.

- Karnopp D, (1985). *Computer simulation of slip-stick friction in mechanical dynamic systems*, Journal of Dynamic Systems, Measurement, and Control, 107H11:100-103.
- Kemal M. Ciliz, Masayoshi Tomizuka (2007), (2007). *Friction modeling and compensation for motion control using hybrid neural network models*, ScienceDirect, Engineering Applications of Artificial Intelligence 20 (2007) 898-911.
- Lampaert V., Swevers J., and Al-Bender F.,(2002). *Modification of the Leuven integrated friction model structure*, IEEE Transactions on Automatic Control, 47, 4, pp. 683-687.
- Lampaert, V., F. Al-Bender and J. Swevers, (2003). *A Generalized Maxwell-Slip friction model appropriate for control purposes*, Proc. of the 2003 Int. Conference on Physics and Control, Saint-Petersbourg, Russia, 1170-1178.
- Ljung, L. (1987). *System Identification: Theory for the User*, Prentice-Hall, Englewood Cliffs, NJ.
- Lörinc Márton and Béla Lantos, (2007). *Modeling, identification, and compensation of stick-slip friction*, IEEE Trans. on Industrial Electronics, vol. 54, no. 1.
- Makkar C.,W.E.Dixon,W.G.Sawyer,and G.Hu, (2005). *A New Continuously Differentiable Friction Model for Control Ssystems Design*, Proceedings of the 2005 IEEE/ASME International Conference on Advaanced Intelligent Mechatronics Monterey,California,USA,24-26 July,2005.
- Morin A.J. (1833). *New friction experiments carried out at Metz in 1831-1833*, In Proc. of the French Royal Academy of Sciences, volume 4, pages 1-128.
- Ohm D.Y., (1990). *A PDFF Controller for Tracking and Regulation in Motion Control*, Proceedings of 18th Conference, Intelligent Motion,Philadelphia,1990
- Oppelt W., (1976). *A historical review of autopilot development, research, and theory in Germany*, Journal of Dynamic Systems, Measurements, and Control, pages 215-23.
- Reynolds, O., (1886). *On the theory of lubrication and its application to Mr. Beauchamp Tower's experiments, including an experimental determination of the viscosity of olive oil*, Phil. Trans. Royal Soc., 177, 157-234.
- Rong-Hwang Horng, Li-Ren Lin and An-Chen Lee, (2006). *LuGre model-based neural network friction compensator in a linear motor stage*, International Journal of Precision Engineering and Manufacturing vol. 7, no.2.
- Schölkopf, B. and Smola A. (2002). *Learning with Kernels*,MIT Press,Cambridge MA, 2002
- Shen, C. N. and H. Wang, (1964). *Nonlinear compensation of a second- and third-order system with dry friction*. IEEE Trans. on Applications and Industry,83(71), 128-136.
- Smola A.J. and B.Schölkopf,(2001). *A tutorial on Support vector Regression*, NeuroCOLT Technical Report NC-TR-98-030, 2001.
- Southward S.S., C.J. Radcliffe, C.R.Mac-Cluer, (1991). *Robust nonlinear stick-slip friction compensation*, J.Dyn. syst.,Meas. Control 113,pp. 639-644.
- Stefan Brock, (2000). *Application of ANFIS controller for two - mass - system*, ESIT 2000, 14-15, Aachen, Germany.
- Sung-Kwun Oh, Witold Pedrycz, Wan-Su Kim, and Hyun-Ki Kim1, (2006). *GA-based polynomial neural networks architecture and its application to multi-variable software process*, Q. Yang and G. Webb (Eds.): PRICAI 2006, LNAI 4099, pp. 834 - 838, 2006.© Springer-Verlag Berlin Heidelberg

- Swevers J., Al-Bender F., Ganseman C., and Prajogo T., (2000). *An integrated friction model structure with improved presliding behavior for accurate friction compensation*, IEEE Trans. on Automatic Control, 45, pp. 675-686.
- Tjahjowidodo, T., Al-Bender, F. and Brussel, HV, (2004). *Friction Identification and Compensation in a DC Motor*, International Journal of JSPE Vol. 32, No. 3, pp. 200-206.
- Tijani Ismaila B., (2009). *Friction Identification and Compensation in Motion Control System using ANFIS and SVM*, Master Thesis, Mechatronics Engineering Department, International Islamic University Malaysia, 2009.
- Tustin A. (1947), *The effects of Backlash and of Speed-Dependent Friction on the Stability of Closed-Cycle Control Systems*, IEEE Journal, vol. 94, part 2A, p.143-51.
- Wahyudi, Sato K. and Shimokohbe A. (2005). *Robustness evaluation of three friction compensation methods for point-to-point (ptp) positioning systems*, Robotics and autonomous system, Elsevier, Vol. 52, Issues 2-3, pp. 247-256
- Wahyudi, (2003). *Friction Identification and Compensation for High Precision Motion Control System - Part 1: Friction Identification*, Proc. of Industrial Electronics Seminar (IES), 2003.
- Wahyudi and Ismaila B. Tijani, (2008). *Friction Compensation for Motion Control System using Multilayer Feedforward Network*, Proceeding of the 5th International Symposium on Mechatronics and its Applications (ISMA08), Amman, Jordan, May 27-29, 2008
- Wen-Fang Xie, (2007). *Sliding-Mode-observer-based adaptive control for servo actuator with friction*, IEEE Trans. On Industrial Electronics, vol. 54, no.
- Vapnik V., (1995). *The Nature of Statistical Learning Theory*, Springer, New York, 1995.
- Yi Guo, Zhihua Qu, Yehuda Braiman, Zhenyu Zhang, and Jacob Barhen, (2008). *Nanontribology and nanoscale friction*, IEEE Control Systems Magazine, vol. 28, no.6, pp. 92-100.
- Zhixiang Hou, Quntai Shen and Heqing Li, (2003). *Nonlinear System Identification Based on ANFIS*, IEEE Int. Conf. Neural Networks & Signal Processing, Nanjing, China, December 14-17, 2003.

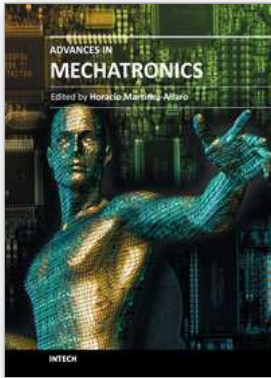

Advances in Mechatronics

Edited by Prof. Horacio Martinez-Alfaro

ISBN 978-953-307-373-6

Hard cover, 300 pages

Publisher InTech

Published online 29, August, 2011

Published in print edition August, 2011

Numerous books have already been published specializing in one of the well known areas that comprise Mechatronics: mechanical engineering, electronic control and systems. The goal of this book is to collect state-of-the-art contributions that discuss recent developments which show a more coherent synergistic integration between the mentioned areas. The book is divided in three sections. The first section, divided into five chapters, deals with Automatic Control and Artificial Intelligence. The second section discusses Robotics and Vision with six chapters, and the third section considers Other Applications and Theory with two chapters.

How to reference

In order to correctly reference this scholarly work, feel free to copy and paste the following:

Tijani Ismaila B., Rini Akmeliawati and Momoh Jimoh E. Salami (2011). Artificial Intelligent Based Friction Modelling and Compensation in Motion Control System, *Advances in Mechatronics*, Prof. Horacio Martinez-Alfaro (Ed.), ISBN: 978-953-307-373-6, InTech, Available from: <http://www.intechopen.com/books/advances-in-mechatronics/artificial-intelligent-based-friction-modelling-and-compensation-in-motion-control-system>

INTECH

open science | open minds

InTech Europe

University Campus STeP Ri
Slavka Krautzeka 83/A
51000 Rijeka, Croatia
Phone: +385 (51) 770 447
Fax: +385 (51) 686 166
www.intechopen.com

InTech China

Unit 405, Office Block, Hotel Equatorial Shanghai
No.65, Yan An Road (West), Shanghai, 200040, China
中国上海市延安西路65号上海国际贵都大饭店办公楼405单元
Phone: +86-21-62489820
Fax: +86-21-62489821

© 2011 The Author(s). Licensee IntechOpen. This chapter is distributed under the terms of the [Creative Commons Attribution-NonCommercial-ShareAlike-3.0 License](#), which permits use, distribution and reproduction for non-commercial purposes, provided the original is properly cited and derivative works building on this content are distributed under the same license.