

Development of Biped Humanoid Robots at the Humanoid Robot Research Center, Korea Advanced Institute of Science and Technology (KAIST)

Ill-Woo Park, Jung-Yup Kim, Jungho Lee, Min-Su Kim, Baek-Kyu Cho
and Jun-Ho Oh
Korea Advanced Institute of Science and Technology (KAIST)
Korea

1. Introduction

Recently, many studies have focused on the development of humanoid biped robot platforms. Some of the well-known humanoid robots are Honda's humanoid robots, the WABIAN series of robots from Waseda University, Partner, QRIO, H6 and H7, HRP and JOHNNIE. Given that humanoids are complex, expensive and unstable, designers face difficulties in constructing the mechanical body, integrating the hardware system, and realizing real-time motion and stability control based on human-like sensory feedback. Among the robots, HRP and ASIMO are the most well known humanoid robot platforms.

HRP-3P is a humanoid robot developed jointly by the National Institute of Advanced Industrial Science and Technology and Kawada Industries, Inc in Japan. It stands 1.6 m tall, weighs 65 kg, and has 36 degrees of freedom (DOF). Upgraded from HRP-2, the new platform is protected against dust and water. In addition, Honda has unveiled a new type of ASIMO, termed the ASIMO Type-R, which stands 1.3 m tall, weighs 54 kg, and has 34 DOF. With the i-WALK technology, this robot has an impressive walking feature: it can walk at 2.7 km/h, and run at 6 km/h.

HUBO is essentially an upgraded version of KHR-2. The objective of the development of HUBO was to develop a reliable and handsome humanoid platform that enables the implementation of various theories and algorithms such as dynamic walking, navigation, human interaction, and visual and image recognition. With the focus on developing a human-friendly robot that looks and moves like humans, one focus was on closely aligning the mechanical design with an artistic exterior design. This chapter also discusses the development of control hardware and the system integration of the HUBO platform. Numerous electrical components for controlling the robot have been developed and integrated into the robot. Servo controllers, sensors, and interface hardware in the robot have been explained. Electrical hardware, mechanical design, sensor technology and the walking algorithm are integrated in this robot for the realization of biped walking. This system integration technology is very important for the realization of this biped humanoid.

The technologies utilized in HUBO are the basis of the development of other HUBO series robot such as Albert HUBO and HUBO FX-1.

Albert HUBO is the only humanoid robot that has an android head and is able to walk with two legs. The face, which resembles Albert Einstein, can imitate human facial expressions such as surprise, disgust, laughter, anger, and sadness. The body, comprising the arms, hands, torso, and legs, is that of HUBO. The body of HUBO was modified to have the natural appearance despite the disproportionate sizes of the head and the body. It can be described as Albert Einstein in a space suit. The realization of a biped walking robot with an android head is a first-in-the-world achievement. The design and system integration between the head and the body are discussed. RC motors are used for the head mechanism, enabling facial expressions. The head and body are controlled by different controllers. The head controller generates facial motions and recognizes voices and images using a microphone and CCD cameras.

HUBO FX-1 is human-riding biped robot. There are a few research results on the subject of practical uses for human-like biped robots. HUBO FX-1 was developed for carrying humans or luggage. This is very useful in the construction or entertainment industries. As HUBO FX-1 uses two legs as transportation method, it offsets the limitations in the use of a wheel and caterpillar. The robot uses AC motors and harmonic drives for joints. As it should sustain heavy weight in the region of 100kg, it requires high power actuators and transmissible high-torque reduction gears.

2. HUBO

2.1 Overall Description

HUBO (Project name: KHR-3) is a biped walking humanoid robot developed by the Humanoid Robot Research Center at KAIST. It is 125cm tall and weights 55kg. The inside frame is composed of aluminum alloy and its exterior is composite plastic. A lithium-polymer battery located inside of HUBO allows the robot to be run for nearly 90 minutes without external power source. All electrical and mechanical parts are located in the body, and the operator can access HUBO using wireless communications. HUBO can walk forward, backward, sideways, and it can turn around. Its maximum walking speed is 1.25km/h and it can walk on even ground or on slightly slanted ground. HUBO has enough degrees of freedom (DOF) to imitate human motions. In particular, with five independently moving fingers, it can imitate difficult human motions such as sign language for deaf people. Additionally, with its many sensors HUBO can dance with humans. It has two CCD cameras in its head that approximate human eyes, giving it the ability to recognize human facial expressions and objects. It can also understand human conversation, allowing it to talk with humans.

HUBO is an upgraded version of KHR-2. The mechanical stiffness in the links was improved through modifications and the gear capacity of the joints was readjusted. The increased stiffness improves the stability of the robot by minimizing the uncertainty of the joint positions and the link vibration control. In the design stage, features of the exterior, such as the wiring path, the exterior case design and assembly, and the movable joint range were critically reconsidered, all of which are shown in Fig. 1. In particular, strong efforts were made to match the shape of the joints and links with the art design concept, and the joint controller, the motor drive, the battery, the sensors, and the main controller (PC) were designed in such a way that they could be installed in the robot itself. Table 1 lists the

specifications of the robot. The following are the design concepts and their strategies in the design of the HUBO platform.

1. Low development cost
 - Rather than using custom-made mechanical parts, commercially available components such as motors and harmonic gears were used in the joints.
2. Light weight and compact joints
 - The power capacity of the motors and reduction gears enables short periods of overdrive due to the weight and size problem of the actuators.
3. Simple kinematics
 - For kinematic simplicity, the joint axis was designed to coincide at one point or at one axis.
4. High rigidity
 - To maintain rigidity, the cantilever-type joint design was avoided.
5. Slight uncertainty of the joints
 - Harmonic drive reduction gears were used at the output side of the joints, as they do not have backlash.
6. Self-contained system
 - All of the components, including the battery, controllers and sensors, are enclosed inside the robot. There are no external power cables or cables for operating the robot.



Figure 1. Humanoid Robot, HUBO

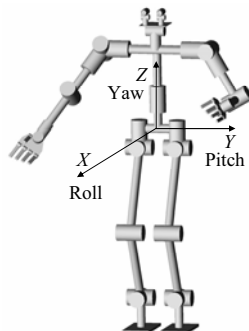

Figure 2. Schematic of the joints and links

Research period	January 2004 up to the present	
Weight	55 kg	
Height	1.25 m	
Walking speed	0 ~ 1.25 km/h	
Walking cycle, stride	0.7 ~ 0.95 s, 0 ~ 64 cm	
Grasping force	0.5 kg/finger	
Actuator	Servomotor + harmonic reduction gear	
Control unit	Walking control unit, servo control unit, sensor unit, power unit, and etc.	
Sensors	Foot	3-axis force torque sensor; accelerometer
	Torso	Inertial sensor system
Power section	Battery	24 V - 20 Ah (Lithium polymer)
	External power	24 V (battery and external power changeable)
Operation section	Laptop computer with wireless LAN	
Operating system	Windows XP and RTX	
Degree of Freedom	41 DOF	

Table 1. Overall Specifications of HUBO

2.2 Mechanical Design

Degrees of Freedom and Movable Joint Angles

Table 2 shows the degrees of freedom of HUBO. Attempts were made to ensure that HUBO had enough degrees of freedom to imitate various forms of human motion, such as walking, hand shaking, and bowing. It has 12 DOF in the legs and 8 DOF in the arms. Furthermore, it can independently move its fingers and eyeballs as it has 2 DOF for each eye (for panning and tilting of the cameras), 1 DOF for the torso yaw, and 7 DOF for each hand (specifically, 2 DOF for the wrist and 1 DOF for each finger). As shown in Fig. 2, the joint axis of the shoulder (3 DOF/arm), hip (3 DOF/leg), wrist (2 DOF/wrist), neck (2 DOF) and ankle (2 DOF/ankle) cross each other for kinematic simplicity and for a dynamic equation of motion.

Head	Torso	Arm	Hand	Leg	Total
2 neck 2/eye (pan-tilt)	1/torso (yaw)	3/shoulder 1/elbow	5/hand 2/wrist	3/hip 1/knee 2/ankle	
6 DOF	1 DOF	8 DOF	14 DOF	12 DOF	41 DOF

Table 2. Degrees of Freedom of HUBO

Table 3 shows the movable angle range of the lower body joints. The ranges are from the kinematic analysis of the walking. The maximum and normal moving angle ranges of the joints are related to the exterior artistic design in Fig. 3. While determining the ranges, a compromise was reached in terms of the angle range and the appearance of the robot.

Joint		Angle range
Hip	Yaw	0 ~ +45°
	Roll	-31° ~ +28°
	Pitch	-90° ~ +90°
Knee	Pitch	-10° ~ +150°
Ankle	Pitch	-90° ~ +90°
	Roll	-23° ~ +23°

Table 3. Movable lower body joint angle ranges of HUBO



Figure 3. Artistic design of HUBO

Actuator (Reduction Gear and DC Motor)

Two types of reduction gears are used: a planetary gear and a harmonic gear. A planetary gear is used for joints such as finger joints, wrist-pan joints, neck-pan joints and eyeball joints, where small errors (such as backlash) are allowable. Errors in the finger and wrist-pan joints do not affect the stability of the entire body or the overall motion of the arms and legs. Harmonic gears are used for the leg and arm, as well as for neck tilt and wrist tilt joints. As a harmonic gear has little backlash on its output side and only a small amount of friction on its input side, it is particularly useful for leg joints, where errors can affect the stability of the entire system and the repeatability of the joint position. This harmonic type of reduction gear is connected to the motor in two ways: through a direct connection and through an indirect connection. The indirect connection requires various power transmission mechanisms (such as a pulley belt or a gear mechanism) between the reduction gear unit and the motor. HUBO has an indirect type of connection for the neck tilt, the shoulder pitch, the hip, the knee, and the ankle joints.

	Joint		Reduction gear type	Input gear ratio	Motor power
Hand	Finger		Planetary gear (256:1)	1.56:1 (pulley belt)	2.64 W
	Wrist	Pan	Planetary gear (104:1)	None	11 W
		Tilt	Harmonic drive (100:1)	2:1 (pulley belt)	
Head	Neck	Pan	Planetary gear (104:1)	None	
		Tilt	Harmonic drive (100:1)	2:1 (pulley belt)	
	Eye	Pan	Planetary gear (256:1)	None	2.64 W
		Tilt		1.56:1(pulley belt)	
Arm	Elbow	Pitch	Harmonic drive (100:1)	None	90 W
	Shoulder	Roll		1:1	
		Pitch			
		Yaw			
Trunk		Yaw	None		

Table 4. Upper body actuators of HUBO

Joint		Harmonic drive reduction ratio	Input gear ratio	Motor power
Hip	Roll	120:1	Gear (2.5:1)	150 W
	Pitch	160:1	Pulley belt (1.78:1)	150 W
	Yaw	120:1	Pulley belt (2:1)	90 W
Knee	Pitch	120:1	Pulley belt (1:1)	150 W*2
Ankle	Roll	100:1	Pulley belt (2:1)	90 W
	Pitch	100:1	Pulley belt (1.93:1)	

Table 5. Lower body actuators of HUBO

The choice of gear types and harmonic drive types was limited by specific design constraints (such as the space, shape, permissible power, and weight). With flexibility in designing the size, shape and wiring, it was easier to develop brushed DC motor drivers compared to other types of motors (such as brushless DC motors or AC motors). The brushed DC motors also have a suitable thermal property. When they are driven in harsh conditions, for example at a high speed and severe torque, the generated heat is less than if brushless DC motors were used. Hence, there is less of a chance that heat will be transferred from the motors to devices such as the sensors or the controller.

There are trade-offs in terms of the voltage of the motor. If the motor has a high voltage, it cannot drive a high current, and vice versa. The voltage of the motors is related to the size and weight of the battery. A high-voltage source requires more battery cells to be connected serially. The number of battery cells is directly related to the weight of the battery system and the weight distribution of the robot.

Weight Distribution

The main controller (PC), the battery, and the servo controller and drivers for the upper body are in the torso. The mass, except for the actuators, was concentrated in the torso due to the need to reduce the load of the actuators in frequently moving parts such as the arms and legs; in addition, it was desired that the torso have sufficiently large inertia for a small amplitude fluctuation. With this approach, the robot achieves low power consumption while swinging its arms and legs; moreover, the control input command ensured a zero moment point with a small positioning of the torso. When the inverted pendulum model is used for gait generation and control, making the legs lighter is important for the realization of biped walking because the model does not consider the weight and the moment of inertia of the lifting leg.

Mechanical Component of Force Torque Sensor (F/T Sensor)

Shaped like a Maltese cross, the F/T sensors can detect 1-force and 2-moment. As shown in Fig. 4, the sensors are attached the wrist ($\Phi 50$) and ankle ($80\text{ mm} \times 80\text{ mm}$). To sense the magnitude of a beam deflection, strain gages are glued onto the points where the load causes the largest strain. These points were located at the ends of the beam but the gages were glued 5 mm apart to minimize the problems of stress concentration and physical space. The ankle sensor was designed for a maximum normal force (F_z) of 100 kg and maximum moments (M_x, M_y) of 50 Nm.

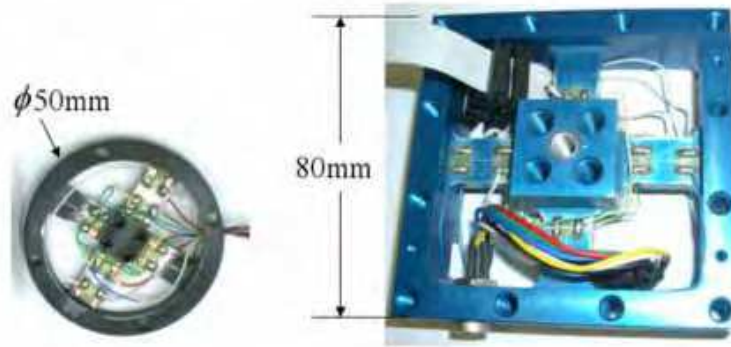

Figure 4. Three-axis F/T sensor

It can be physically assumed that the distance between the sole and the sensor is negligible and that the transversal forces in the x-y plane are small. From the principle of equivalent force-torque, the sensor-detected moment is then

$$M_{Sensor} = M_{ZMP} + r \times F_{ZMP} \quad (1)$$

where

$$F_{ZMP} = \begin{bmatrix} F_x \\ F_y \\ F_z \end{bmatrix}, \quad M_{Sensor} = \begin{bmatrix} M_{s,x} \\ M_{s,y} \\ M_{s,z} \end{bmatrix}, \quad r = \begin{bmatrix} r_x \\ r_y \\ r_z \end{bmatrix}.$$

This 3-axis F/T sensor can only sense $F_z, M_{s,x}, M_{s,y}$. By the definition of ZMP, the moment at ZMP is $M_{ZMP} = 0$. It can be assumed that the F/T sensor is on the sole and that the transversal

forces in the x-y plain are small. In this case, $r_z F_x$ and $r_z F_y$ are negligible. Through a simple calculation, the relationship between the ZMP and the detected force/moment are

$$r_x \approx -\frac{M_y}{F_z}, r_y \approx \frac{M_x}{F_z} \quad (2)$$

2.3 Control Hardware System

The hardware architecture of the control system is shown in Fig. 5, and the location of the hardware components is displayed in Fig. 6. A Pentium III-933MHz embedded PC with the Windows XP operating system (OS) is used as the main computer. Other devices such as servo controllers (joint motor controller) and sensors are connected to the controller area network (CAN) communication lines to the main computer. The robot can be operated via a PC through a wireless LAN communications network. The main computer serves as the master controller. The master controller calculates the feedback control algorithm after receiving the sensor data, generates trajectories of the joints, and sends the control command of the robot to the servo controller of the joints via CAN communication.

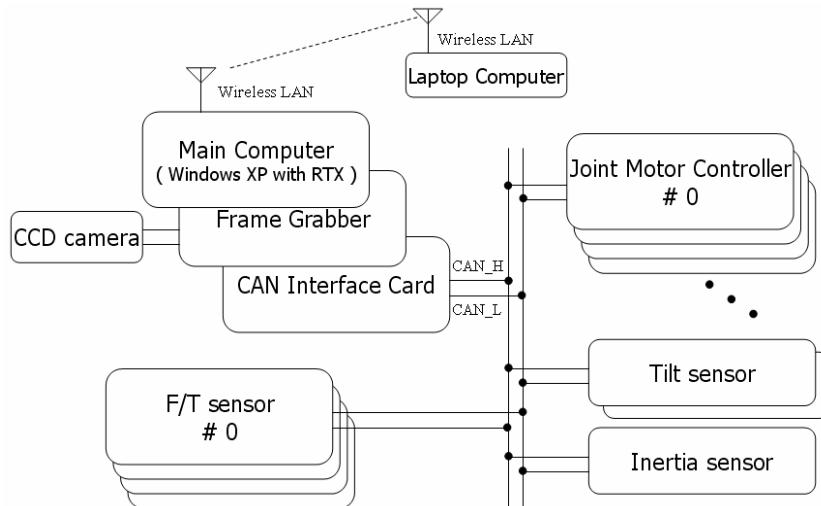

Figure 5. Control System Hardware of HUBO

The software architecture of the OS is shown in Fig. 7. Windows XP operates the main controller for the convenience of software development and for system management. Windows XP is a common OS, which is easy for the developer to access and handle. This widespread OS made it possible to develop the robot control algorithm more effectively, as it is easy to use with free or commercial software and with hardware and drivers. A graphical user interface (GUI) programming environment shortened and clarified the development time of the control software. However, the OS is not feasible for real-time control. Real-time extension (RTX) software is the solution for this situation. The operational environment and the GUI of the robot software were developed in the familiar Windows XP, and a real-time control algorithm including the CAN communications was programmed in RTX.

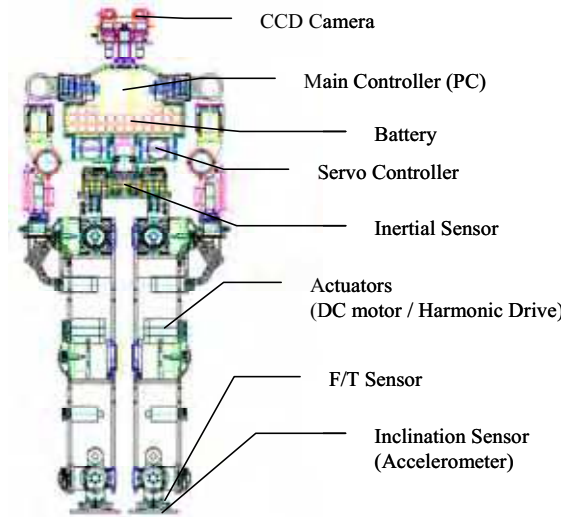

Figure 6. Hardware System Structure of HUBO

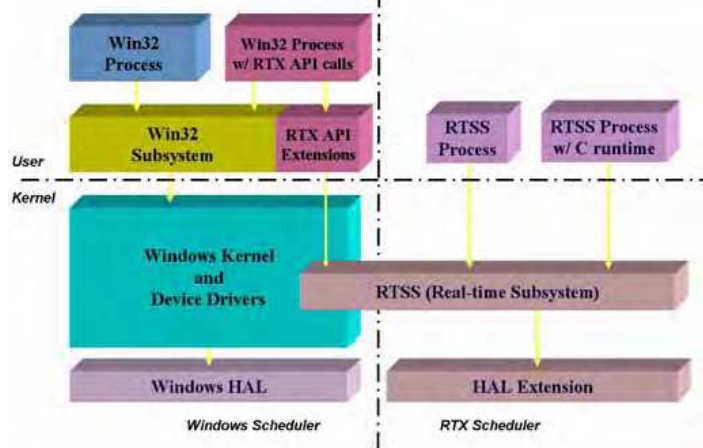

Figure 7. Software Architecture of the OS

Brushed DC motors were used for joint actuators. The motors, as used in this robot, are divided by their power capacity. High-power motors are used for joints such as the hip, knee, ankle, shoulder, elbow and torso. These joint actuators require high levels of torque, speed and reliability. For example, the motors used in the lower limb are directly related to the walking performance and stability of the robot. In addition, the arm joint motors also require high power as it was desired that the robot could imitate human motions such as bowing, sign language, and simple dancing. Low-power motors are used for joints such as the fingers, wrists, neck, and eyes. These motors have little connection to the overall walking stability of the robot; they were added for the decoration of motion. Two types of servo controllers were developed: a low-power controller and a high-power controller.

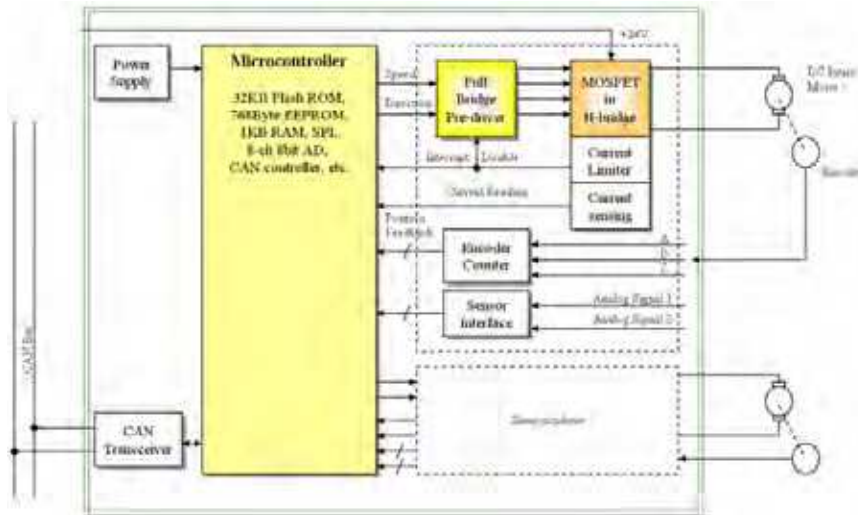

Figure 8. Hardware Configuration of the Servo controller

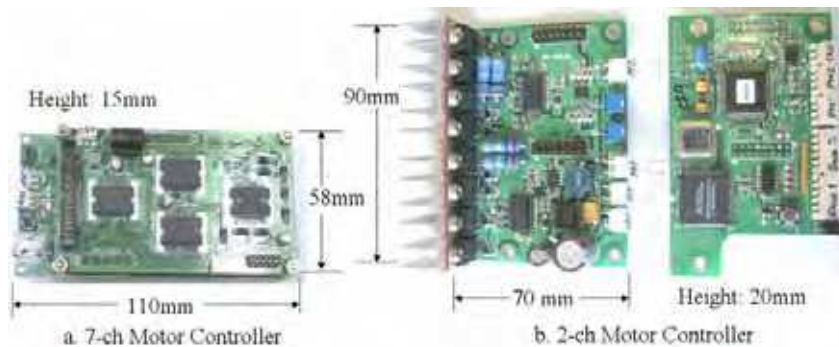

Figure 9. Servomotor Controllers

The controllers operate at 1000Hz, which interpolates linearly the position command issued by the main controller at a frequency of 100Hz. The detailed hardware configuration and the features of the controllers are shown in Figs. 8 and 9. As mentioned above, two types of servo controllers were used; these are shown in Fig. 9. Both are composed of a microcontroller module and power amplifier module. The microprocessor module receives the joint position commands, controls a real DC motor using given commands and encoder counting, and sends the actual position or current data of the motors. Fig. 9a shows low-power servo controllers that control the low-powered joints. These controllers can control 7-channel motors. There is also a 5-channel A/D port for additional sensors such as the pressure sensors in the fingertips. The power capacity is 40W/ch for the head and hand joints, which requires low power, a small space, and multiple motors. The other type of servomotor, as shown in Fig. 9, controls the high-power DC motors. It can handle 2-channel motors and a 2-channel A/D port for additional sensors such as accelerometers. It has a channel power capacity of 480W, allowing it to control the high-power motors.

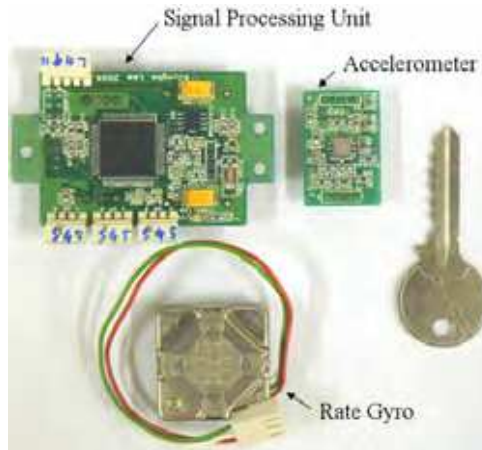

Figure 10. Inertia Sensor System

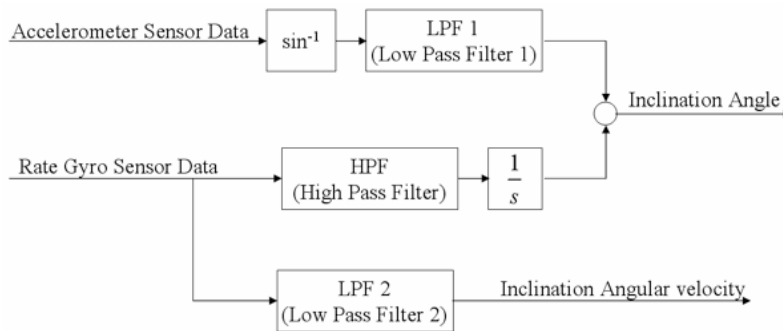

Figure 11. Signal Processing Block Diagram of the Inertia Sensor System

HUBO has an inertia sensor system enclosed in its chest. The walking control algorithm of the robot uses the attitude sensor actively. The inertia sensor system is composed of a 2-channel accelerometer, a 2-channel rate gyro and a signal-condition processor board, as shown in Fig. 10. In practice, the accelerometer can sense the robot's inclination using an arcsine function. However, it is very sensitive to unwanted acceleration resulting from a shock or a jerk. The rate gyro is good for sensing the angular velocity, but it drifts under a low frequency. Therefore, it is necessary to utilize signal-processing methods. As shown above in Fig. 11, the robot's attitude and its rate of change can be used instead. The sensor measures the inclination of the torso; the angle control is very important for the robot's stability and in terms of repeatability.

3. Albert HUBO

The design concept of the android-type humanoid robot Albert HUBO is described as follows:

1. A human-like head with a famous face
2. Can hear, see, speak, and express various facial expressions.

3. Can walk dynamically
4. Spacesuit-type exterior
5. Long battery life per single charge
6. Self-contained system
7. Two independent robotic systems of a head and a body

Albert HUBO is an android-type humanoid robot with a human face, as shown in Fig. 12. It has a height of 137 cm, a weight of 57 Kg, and 66 degrees of freedom. Essentially, its frame structures and systems are based on HUBO, which is a biped humanoid robot explained in a previous section. Based on HUBO, the control system architecture, battery capacity, and head system were upgraded. The head and body are independent robotic systems; accordingly, they have different roles. The head system manages intelligent human-robot interactions while the body system performs movements such as biped walking. Hence, the battery capacity was enlarged in order to power these two robotic systems sufficiently.



Figure 12. Albert HUBO

	Albert HUBO	HUBO
Height	137 cm	125 cm
Weight	57 kg	55 kg
DOF	66	41
Actuator	Brushed DC motor + RC servomotor	Brushed DC motor

Table 6. Mechanical Specifications of Albert HUBO and HUBO

Computer	Main computer 1	Pentium III 1.1GHz
	Main computer 2	Pentium III 933MHz
Operating System	General OS	Windows XP
	Real time OS	RTX
Communication	Internal	CAN
	External	IEEE 802.11g
Vision	Vision system using CCD Cameras	
Voice	Voice recognition and voice synthesis	

Table 7. System Specifications of Albert HUBO

Table 6 and 7 present the simple and overall specifications of Albert HUBO. The robot uses two PCs. The first of these is termed main computer 1, which mainly handles the role of head motion control. The controller generates head motions such as the facial expressions. It also processes vocal expression data and CCD camera image data from the microphone and CCD camera, respectively. The second PC is termed main computer 2, which mainly handles motions and the walking control of the entire robot system apart from the head. It controls walking and motions analogous to the main computer of HUBO.

Android Head Design

Historically, the entertainment industry has most aggressively explored realistic and nearly realistic robotic hardware for use in movies and theme parks. The field of such entertainment devices is known as “animatronics.” These machines have taken a wide diversity of form, from the realistic “Abe” Lincoln of Disneyland, to the bizarre aliens of the “Men in Black” movies.

In the field of animatronics, problems of costliness, low expressivity, and power consumption all result from the physical dissimilarity of the simulated facial soft tissues of animatronics relative to real human tissues. Human facial soft tissues are mostly liquid, filling cellular membranes approximating billions of tiny water balloons. The liquid molecules will slide into any geometry that the membranes can tolerate. In this way, the human face is like a sealed wet sponge. Animatronic facial tissue on the other hand, is made of solid elastomers (e.g. rubber), which are typically composed of tangled, spring-like polymer molecules that unwind when elongated but are geometrically interlocked. Thus, these molecules are fundamentally restricted from reproducing the geometric plasticity of human facial tissues. In effect, the force required to move animatronics materials expressively are orders of magnitude above that required by facial soft tissues.

To resolve these issues, Hanson Robotics developed a series of methods for creating sponge-like elastomer materials that move more like facial soft-tissues. These materials, known collectively as “Frubber” (a contraction of “flesh” and “rubber”), wrinkle, crease, and amass much more like skin than do animatronics materials. They also consume very little power – less than 10W – while affecting a full range of facial expressions and speech-related mouth motions. In tests, the material requires less than 1/22nd the force and energy to move into facial expressions relative to animatronics materials.

The reduced energy consumption enables battery-powered biped walking. Being porous, Frubber also weighs much less, which is also a benefit for untethered walking robots. Such integration with a walking gesture-capable body is significant as it allows an exploration of the aesthetics of the entire, integrated humanoid figure as an autonomous social being.

As shown in Fig. 13, Frubber is used for Albert HUBO's facial skin. In addition, twenty-eight RC servomotors for the facial movements and three RC servomotors for the neck movements are used in order to generate a full range of facial actions and expressions, such as laughs, sadness, anger, or surprise. The servomotors are linked with the various points of Albert HUBO's face through strings. Therefore, the face motions are generated by drawing or releasing strings linked to various points on the face such as the eyebrows, eyes, jaws, lips, and other points.



Figure 13. The head of Albert HUBO

To control the thirty-one RC servomotors, the mini SSC II (Scott Edwards Electronics) is used as the head motor controller. The main controller sends the position data via RS-232 signals to the head motor controller. The head motor controller then converts the RS-232 signals to PWM signals in order to drive the thirty-one RC servomotors. The head motor controller sends the PWM signals to the RC servomotors without feedback, as the RC servomotors incorporate feedback control circuits in their systems.

Body Design

The most important part of the design of Albert HUBO is the torso, as numerous important parts are densely crowded into this space. Thus, a high level of space efficiency is required. For example, the speaker and microphone systems, two main computers, a Li-Polymer battery, a Ni-MH battery, joint motor controllers, an inertial sensor, and a switch panel are located in the torso. To support this hardware, the torso is composed of a rectangular-shaped chest frame and two supporting columns between the chest and the pelvis. Fig. 14 shows a 2D drawing of Albert HUBO's body. By locating many parts into the torso, which does not have joints, energy consumption can be reduced during dynamic motions. The dimensions of robot body were determined in consideration of a human body. However, the distance between the right and left shoulders was designed to be greater than that of a human due to a spacesuit-like exterior.

The body frames and covers of HUBO were modified to connect them with an android head. The main design problem of the Albert HUBO project was the natural connection of the machine-shaped body and the realistic human-like head. More specifically, it was important to provide the best image to people without an unusual appearance. To match the robotic body with the human-like head, the authors conceived of Albert Einstein's face and coupled it with a spacesuit-type body exterior, as the spacesuit gives the robot a scientific and robotic appearance. This was felt to be well matched with the image of Albert Einstein in this regard.

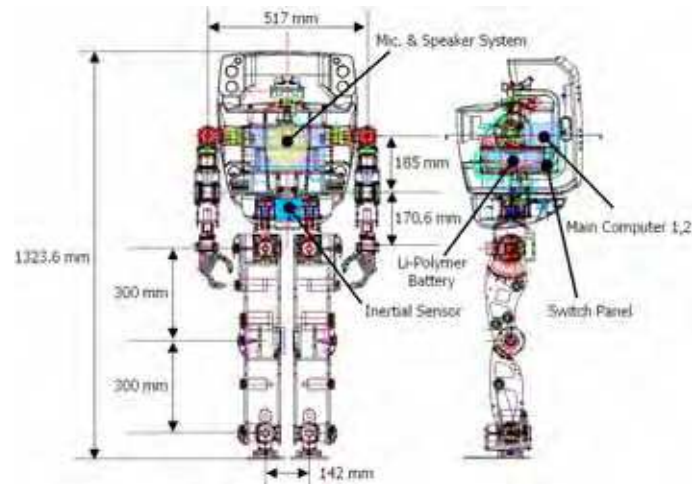

Figure 14. 2D drawing of Albert HUBO's body

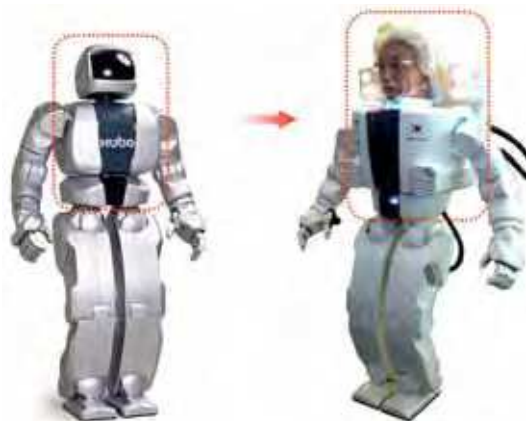

Figure 15. Modified parts of the HUBO Platform

During the body styling process, there was an unexpected problem: the head was out of proportion with the body. This problem was serious, as the robot may have appeared overly unusual. The first design alternative was an inverted triangle shape for the body, applying a perspective effect. As ordinary people understand the perspective view well, they do not recognize distortions regarding the depth of perspective until these distortions are large. As modern people are familiar with different camera views or screen angles used with movie cameras, they naturally recognize distortion from a lens as well. A normal adult looks down Albert HUBO from a high vantage point, because a person of normal height is taller than the robot. Thus, to someone looking at the robot, the upper body appears wider and the lower body narrower. This effect becomes greater as the distance between the viewer and the robot becomes closer and as the view angle becomes higher. If the perspective obtained from a high viewpoint is applied to the styling, an inverted-triangle robot shape results, as shown in Fig. 16.

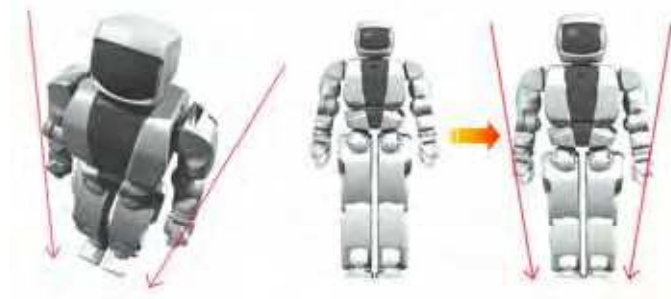

Figure 16. Distorted image with the perspective view and its application

In spite of various points of view, people are reminded of the shape from the viewpoint of a camera from a high viewing angle. This case represents the natural situation shown in Fig. 17.

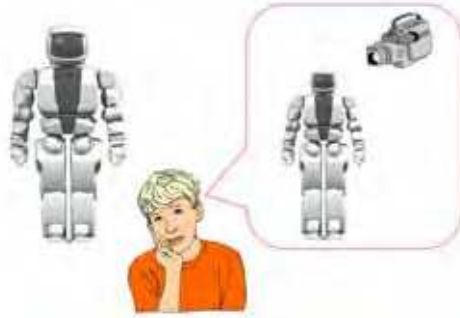

Figure 17. Seeing the distorted robot, people imagine the image from the perspective of a camera

For the upper body cover design, an inverted conic shape was applied in order to prevent distortion from the side quarter view. Hence, the arm parts were moved approximately 45 mm more to the outside from the body center in order to expand the upper body. The pelvis cover was contracted compared to the original HUBO platform. To minimize the expansion of the upper body cover, it was made to be round so that it would not interfere with shoulder and neck, as shown in Fig. 18.



Figure 18. Design of the upper body cover

The second design alternative was a reduction of the exposure of the head (except for face, as it is the most important part in Albert HUBO body styling). To shade the back of the head, the backpack was expanded to the ears. The backpack protects the head from impacts, adds room for inner mechanic parts and controllers, and acts as a base for the attachment of various types of equipment as shown in fig. 19.



Figure 19. The backpack of Albert HUBO

The third design alternative was the application of effective lighting (shown in Fig. 20.). The sidelights on the head can disperse a spectator's sight when concentrated on the head. Furthermore, these powerful halogen lights make a dramatic effect when the robot presents on the stage in an artificial fog. Additional blue LED lights in the neck and the shoulder connection parts offer a feeling of mystique or a fantasy mood. In particular, the LED light in the neck shades the gap in the connection between the head and body and drives a spectator's sight to the face.



Figure 20. The lights around the head and those of the shoulder connection, and the front of the waist

System Integration

The motion control structure is shown in Fig. 21. Albert HUBO behaves with intelligent activities and body motions. The intelligent activities are the visual processing, voice recognition, and facial expressions of the robot. The body motions are upper body motions, gait pattern planning, and posture stabilization. The upper body motions are for interactions with humans or for the accomplishment of tasks. Gait pattern planning generates the biped walking motions, and posture stabilization based on sensory feedback is combined with other motions in order to maintain the balance of the robot continually. Both of the intelligent motions and body motions interact with the environment through the use of CCD cameras, a microphone, a speaker, force/torque sensors, an inertial sensor, and tilt sensors.

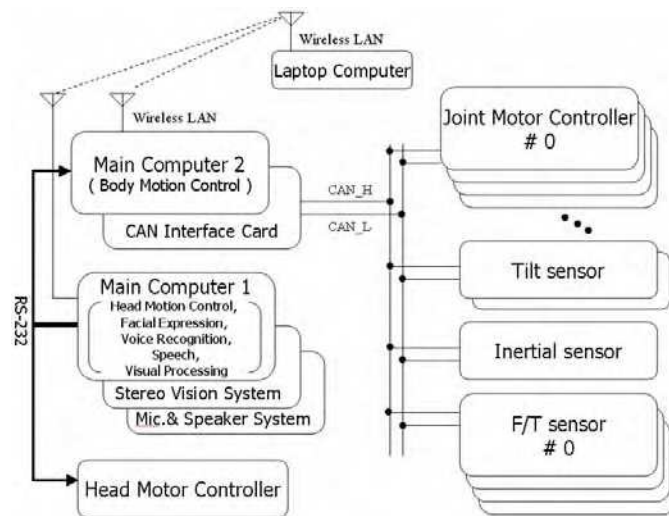

Figure 21. Schematic of Albert HUBO system

Using this motion control structure, the robot achieves human-robot interactive functions. For example, if a man commands Albert HUBO to bring a certain item, Albert HUBO initially judges whether the commander is his master by means of the voice and face. If the commander is his master, Albert HUBO replies with a positive answer and with a smile. Following this, Albert HUBO searches for the target item using the biped walking and vision systems. When the target item is found, Albert HUBO grasps it using an upper body motion and CCD cameras. Finally, Albert HUBO passes the target item to his commander. In this way, a simple intelligent job can be realized.

	Main Computer 1 (Head)	Main Computer 2 (Body: Arms and Legs)
Expansion	PC104+	PC104+ and PC104
Power Consumption	Typical 5V@ 2.3A, 12V@0.5mA Max 5V@ 3.68 A, 12V@0.5mA	Typical 5V@3.5A, 12V@0.02A Max 5V@3.99 A, 12V@0.08A
Size/Weight	108 mm x 115 mm, 0.279 Kg	96 mm x 115 mm, 0.2 Kg
Operating System	Windows XP	Windows XP + RTX

Table 8. Specifications of the main computers

4. HUBO FX-1

HUBO FX-1 was developed for research concerning applications of a biped walking robot. HUBO FX-1 is a scaled-up version of the original HUBO's lower body, and is useful in industrial fields. Heavy industrial companies need robots that can carry heavy materials, thus this type of robot can be seen as a milestone in industrial robot history. HUBO FX-1 will be used for a transportation system that can carry heavy materials or a human. HUBO FX-1 is a transportation system based on HUBO's lower body. It can transport luggage in an industrial field or a human by modification of the seat or upper body. HUBO FX-1 is scaled up to 1.5 times of the original HUBO, and is capable of generating larger power movements. It can carry luggage or a human weighing up to 100kg and can walk stably. To walk with 100kg, additional parts were added in an effort to increase its stiffness. An operator can control HUBO FX-1 via wireless communications or using a joystick located in its upper body (seat).

Overview of HUBO FX-1

HUBO FX-1 has 12 DOF, including 2 DOF in its ankle, 1 DOF in its knee and 3 DOF in the hip for each leg. Fig. 22 shows HUBO FX-1 with a seat for carrying a human. Except for its upper body, the height of HUBO FX-1 is 1.393m and its weight is about 130Kg. It can walk at 1.25Km/h. All of the main controllers and other devices are embedded in the robot. Therefore, operators can control HUBO FX-1 through a wireless network and a joystick. The former HUBO's walking algorithm was applied, and the algorithm was verified as very stable. Table 9 shows overall specifications of HUBO FX-1.



Figure 22. HUBO FX-1 (Human Riding Biped Walking Robot)

Research Term	2005.04~	
Height and Weight	1.393m(1.988 with chair) and 130Kg(150Kg with chair)	
Walking Speed	1.25Km/h	
Actuator	AC Servomotor + Harmonic Reduction Gear + Drive Unit	
Control Unit	Main controller, sub-controller and AC servo controller	
Sensor	Foot	3-Axis Force-Torque Sensor and Inclinometer
	Torso	Rate-Gyro and Inclinometer
Power	External AC power(220V)	
Operation	Windows XP and RTX with Wireless network and joystick	
DOF	12 DOF	

Table 9. Specifications of HUBO FX-1

Actuator and Reduction Gear

An AC servomotor is used for actuating HUBO FX-1 joints. The type of DC motor that is generally used for the other type of biped robots, such as HUBO, is not sufficient for the expected design parameters in this case. Each motor and reduction gear for the joints was selected using computer simulation to withstand its own weight and a 100Kg payload (maximum). In addition, to minimize backlash phenomenon on the output side of the joint reduction gear, a Harmonic Drive reduction gear was utilized in each joint. These are connected to the motor by pulley-belt system to adjust the reduction ratio easily. Table 10 outlines the AC motor and the Harmonic Drive reduction gears.

AC Servomotor	400Watt	Max. torque	1.27 Nm
		Inertia	0.34 gf·cm·s ²
		RPM	5000 rpm
	800Watt	Max. torque	2.39 Nm
		Inertia	1.08 gf·cm·s ²
		RPM	5000 rpm
Harmonic Drive	CSF-25	Reduction ratio	100:1
		Max. torque	108 Nm
	CSF-32	Reduction ratio	100:1
		Max. torque	212 Nm

Table 10. Actuators and reduction gears used in the robot joints

Control Hardware

The electrical parts of HUBO FX-1 differ from the former HUBO series. As HUBO FX-1 uses AC servomotors and the former HUBO series use small DC motors, there are additional electrical devices. Fig. 23 shows overall structure of the system.

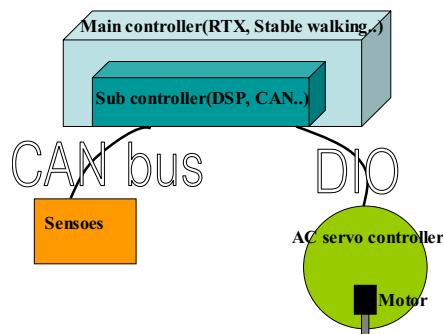

Figure 23. Overview of control system

The Windows XP operating system is utilized as the main operating system, while RTX is used for real time control. Controllers are made up of a main controller (PC), a sub-controller (controller board using DSP and PLX) and an AC servo controller (Servomotor controller of the AC motor), and sensors are made up of a 3-axis force-torque sensor, a rate gyro sensor and an inclinometer. Sensors communicate with the main controller using the CAN communication protocol.

The main controller has a PCI bus-type sub-controller, which the former HUBO series robots do not have. The main controller conducts the control algorithm using sensor signals and

offers reference position information for each motor to the sub-controller during a 0.01s time period. The sub-controller offers reference position and direction signals for each motor at 50 KHz. These are created by a DDA (Digital Differential Analysis) algorithm and are sent to the AC servo controller based on this information (Fig. 24.).

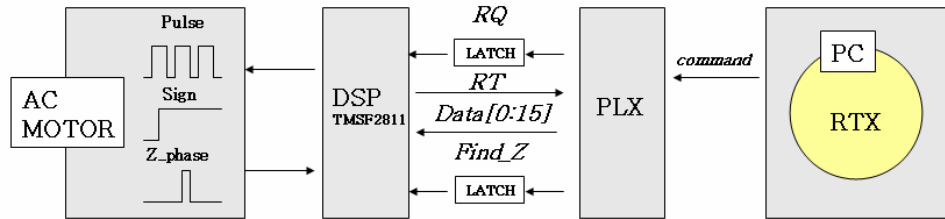

Figure 24. Control system diagram of the sub-controller

Using this procedure the AC servo controller controls each motor. Fig. 25 shows a timing diagram of the sub-controller. The PLX sets the RQ signal to high in order to inform the DSP that the data is valid. The DSP then receives the data and returns an RT signal as an acknowledgement to the PLX. This procedure is conducted twelve times every 10msec, and all information necessary for the control of the motors are transmitted to DSP.

The sub-controller has a CAN communication module. It is used for communicating with the sensors. SJA1000 is a stand-alone CAN controller manufactured by Philips, which has inner Rx/Tx buffers, a bit stream processor and an acceptance filter. It supports the CAN 2.0B protocol and has a maximum 1Mbps communication speed. PCA82C250 as a CAN transceiver has a 1Mbps baud rate and a maximum 50nsec propagation delay.

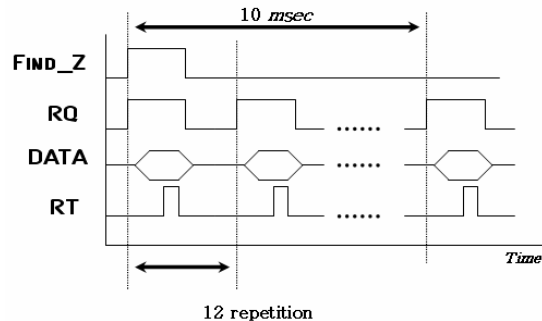

Figure 25 Timing diagram of the sub-controller

5. Conclusion and Future Work

In this chapter, The HUBO-series robot platform development is introduced. HUBO, Albert HUBO, and HUBO FX-1 are biped humanoids. Each robot has its own character. HUBO is a biped humanoid robot. The major function of this robot is to walk with its two legs and imitate the human's motions such as hand shaking, bowing, and communicating in sign language. The system components of the control hardware are connected using a CAN communication line. The control system of HUBO is based on the distributed control

architecture; all of the joints and sensors have their own microprocessors. The main controller sends a control command to the servo controller and receives environmental data from the sensor-signal condition board through CAN. This system architecture is similarly applied to the Albert HUBO and HUBO FX-1 robots.

Albert HUBO is a biped humanoid robot, which has a human-like (appearing as the famous physicist Albert Einstein) android head. It can be regarded as a robot with two independent robot systems i.e. a head and a body system. There is a main controller in each system, and communications are conducted using the RS232 protocol. For a natural appearance, in spite of the disproportion in size between the head and the body, the concept of Albert Einstein in a space suit was adopted. In addition, a number of artistic design approaches are applied to the robot.

HUBO FX-1 is a human-riding robot that can carry nearly 100kg. It can carry humans with of various weights. To enable it to walk with a heavy object, aspects of the mechanical design of the robot were thoroughly considered, including the stiffness of the robot frame structure, as well as the actuators and the reduction gears. The control system hardware differs from HUBO and Albert HUBO. It uses a PCI bus-based sub-controller containing a DSP processor, and CAN is used for sensor data communications.

6. References

- K. Hirai, M. Hirose, Y. Haikawa, and T. Takenaka, The Development of Honda Humanoid Robot, in *Proc. IEEE Int. Conf. on Robotics and Automations*, pp.1321-1326, 1998.
- Y. Sakagami, R. Watanabe, C. Aoyama, S. Matsunaga, N. Higaki, and K. Fujimura, The Intelligent ASIMO: System Overview and Integration, in *Proc. IEEE/RSJ Int. Conf. on Intelligent Robots and Systems*, pp. 2478-2483, 2002.
- J. Yamaguchi, A. Takanishi, and I. Kato, Development of a Biped Walking Robot Compensating for Three-Axis Moment by Trunk Motion, in *Proc. IEEE/RSJ Int. Conf. on Intelligent Robots and Systems*, pp.561-566, 1993.
- K. Nishiwaki, T. Sugihara, S. Kagami, F. Kanehiro, M. Inaba, and H. Inoue, Design and Development of Research Platform for Perception-Action Integration in Humanoid Robot: H6, in *Proc. IEEE/RJS Int. Conf. on Intelligent Robots and Systems*, pp.1559-1564, 2000.
- K. Kaneko, F. Kanehiro, S. Kajita, K. Yokoyama, K. Akachi, T. Kawasaki, S. Ota, and T. Isozumi, Design of Prototype Humanoid Robotics Platform for HRP, in *Proc. IEEE Int. Conf. on Intelligent Robots and Systems*, pp.2431-2436, 1998.
- M. Gienger, K. Loffler, and F. Pfeiffer, Towards the Design of Biped Jogging Robot, in *Proc. IEEE Int. Conf. on Robotics and Automation*, pp.4140-4145, 2001.
- K. Akachi, K. Kaneko, N. Kanehira, S. Ota, G. Miyamori, M. Hirata, S. Kajita, and F. Kanehiro, Development of Humanoid Robot HRP-3P, in *Proc. of IEEE-RAS Int. Conf. on Humanoid Robots*, pp.50-55, 2005.
- I.W. Park, J. Y. Kim, S.W. Park, and J.H. Oh, Development of Humanoid Robot Platform KHR-2 (KAIST Humanoid Robot - 2), *Int. Conf. on Humanoid* 2004.



Humanoid Robots, Human-like Machines

Edited by Matthias Hackel

ISBN 978-3-902613-07-3

Hard cover, 642 pages

Publisher I-Tech Education and Publishing

Published online 01, June, 2007

Published in print edition June, 2007

In this book the variety of humanoid robotic research can be obtained. This book is divided in four parts: Hardware Development: Components and Systems, Biped Motion: Walking, Running and Self-orientation, Sensing the Environment: Acquisition, Data Processing and Control and Mind Organisation: Learning and Interaction. The first part of the book deals with remarkable hardware developments, whereby complete humanoid robotic systems are as well described as partial solutions. In the second part diverse results around the biped motion of humanoid robots are presented. The autonomous, efficient and adaptive two-legged walking is one of the main challenge in humanoid robotics. The two-legged walking will enable humanoid robots to enter our environment without rearrangement. Developments in the field of visual sensors, data acquisition, processing and control are to be observed in third part of the book. In the fourth part some "mind building" and communication technologies are presented.

How to reference

In order to correctly reference this scholarly work, feel free to copy and paste the following:

Ill-Woo Park, Jung-Yup Kim, Jungho Lee, Min-Su Kim, Baek-Kyu Cho and Jun-Ho Oh (2007). Development of Biped Humanoid Robots at the Humanoid Robot Research Center, Korea Advanced Institute of Science and Technology (KAIST), Humanoid Robots, Human-like Machines, Matthias Hackel (Ed.), ISBN: 978-3-902613-07-3, InTech, Available from:

http://www.intechopen.com/books/humanoid_robots_human_like_machines/development_of_biped_humanoid_robots_at_the_humanoid_robot_research_center__kaist_

INTECH

open science | open minds

InTech Europe

University Campus STeP Ri
Slavka Krautzeka 83/A
51000 Rijeka, Croatia
Phone: +385 (51) 770 447
Fax: +385 (51) 686 166
www.intechopen.com

InTech China

Unit 405, Office Block, Hotel Equatorial Shanghai
No.65, Yan An Road (West), Shanghai, 200040, China
中国上海市延安西路65号上海国际贵都大饭店办公楼405单元
Phone: +86-21-62489820
Fax: +86-21-62489821

© 2007 The Author(s). Licensee IntechOpen. This chapter is distributed under the terms of the [Creative Commons Attribution-NonCommercial-ShareAlike-3.0 License](#), which permits use, distribution and reproduction for non-commercial purposes, provided the original is properly cited and derivative works building on this content are distributed under the same license.