

Optoelectronic Oscillators

Patrice Salzenstein

*Centre National de la Recherche Scientifique (CNRS)
Franche Comté Electronique Mécanique Thermique Sciences
et Technologies (FEMTO-ST) Institute, Besançon
France*

1. Introduction

Optoelectronic oscillator was invented in 1994 by Yao and Maleki, two researchers of the NASA Jet Propulsion Laboratory [1]. The aim of this oscillator was first to generate microwave signal with particularly low phase noise. The best results is -163 dBc/Hz at 10 kHz from a 10 GHz carrier. This system was initially developed for next generation radar to replace microwave generators. Then new applications appear for time and frequency, telecommunication, and navigation technology. Few years ago were published first Optoelectronic Oscillators (OEO) with fiber loop [2,3], affordable for telecommunication systems with adjustable frequency chosen with band filter value. But optical fiber are still bulky because of their several km packaged lengths and bring difficulties with temperature control. However with a 4 km optical delay line in OEO, a 10 GHz oscillator prototype exhibits a frequency flicker of 3.7×10^{-12} (Allan deviation) and a phase noise lower than -140 dB.rad²/Hz at 10 kHz off the carrier [4]. The choice of integrating a mini-resonator is a way to reach problems related to regulation of temperature and to work in limited volume, necessary condition for building transportable sources. Optical fiber delay line is replaced by a whispering gallery mode (WGM) optical mini-resonator in simple topology of OEO. Optical signal can propagate by total internal reflection by WGM inside the crystal resonator. One can then achieve a long equivalent delay line into the few millimeter diameter optical mini-disk resonator. High quality factor were demonstrated [5]. In this chapter are presented main principle of OEO. The interest to build such an oscillator is that the expected microwave frequency that modulate the optic carrier can be increased without

1: X. S. Yao and L. Maleki, „High frequency optical subcarrier generator,“ *Electronics Letters*, 30(18), 1525 (1994)

2: A. Neyer, E. Voges, "High frequency electro optic oscillator using an integrated interferometer," *Appl. Phys. Lett.* 40(1), 6-8 (1982)

3: X. S. Yao, L. Maleki, "Optoelectronic microwave oscillator," *J. Opt. Soc. Am. B* 13(8), 1725-1735 (1996)

4: K. Volyanskiy, J. Cussey, H. Tavernier, P. Salzenstein, G. Sauvage, L. Larger, and E. Rubiola, "Applications of the optical fiber to the generation and measurement of low-phase-noise microwave signals," *J. Opt. Soc. Am. B* 25(12), 2140-2150 (2008)

5: I. S. Grudinin, V. S. Ilchenko, L. Maleki, "Ultrahigh optical Q factors of crystalline resonators in the linear regime," *Phys. Rev. A* 74, 063806(9) (2006)

loosing stability. Main limitation are then in the ability to find stable enough components such as high speed photo detectors.

2. How works an OEO

An OEO is an oscillator typically delivering a microwave signal. Purity of microwave signal is achieved thanks to a delay line inserted into the loop. For example, a 4 km delay corresponds to 20 μ s time for optical energy to stay in the line. It is equivalent to a quality factor $Q=2\pi FT$ where F is the microwave frequency and T the delay induced by the delay line. The continuous light energy coming from a laser is converted to microwave signal. The loop of the oscillator consists in an optic and an electric part as systematized on the following figure. Light from the laser goes through a modulator. The modulation microwave signal comes from the output of the microwave amplifier after crossing a -10dB directional coupler. Resonant element can be an optic fiber equivalent to a delay line. It can also be an optical mini-resonator coupled to the optical fiber at the output of the phase modulator. The microwave signal is amplified after the photodiode. OEO can have optic output with the modulated optical signal and microwave output through a directional coupler. The oscillator consists of an amplifier of gain G and a feedback transfer function $\beta(f)$ in a closed loop. The gain G compensates for the losses, while $\beta(f)$ selects the oscillation frequency. Barkhausen condition gives $G\beta(f) = 1$.

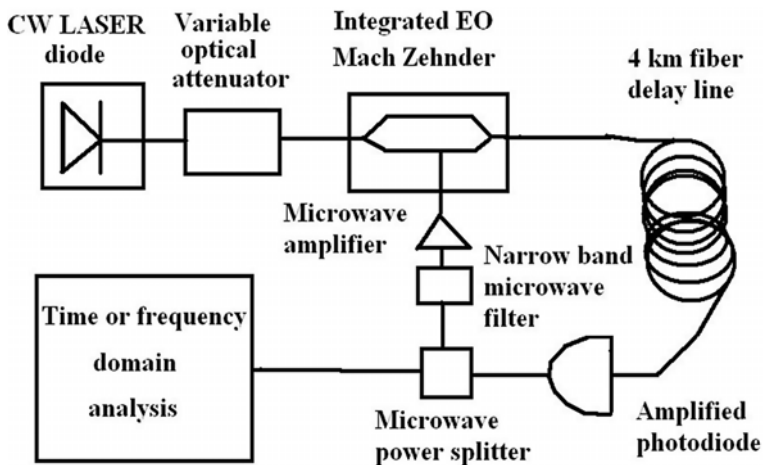

Fig. 1. Typical architecture of a fiber delay line OEO realized at FEMTO-ST institute

The optical fiber is a good choice for several reasons explained in this paragraph. A long delay can be achieved, of 100 μ s and more, thanks to the low loss (0.2 dB/km at 1.55 μ m and 0.35 dB/km at 1.31 μ m). The frequency range is wide, at least of 40 GHz, still limited by the optoelectronic components. The background noise is low, close to the limit imposed by the shot noise and by the thermal noise at the detector output. The thermal sensitivity of the delay ($6.85 \times 10^{-6}/K$) is a factor of 10 lower than the sapphire dielectric cavity at room temperature. This resonator is considered the best ultra stable microwave reference. In oscillators and phase-noise measurements the microwave frequency is the inverse of the

delay. This means that the oscillator or the instrument can be tuned in steps of 10^{-5} – 10^{-6} of the carrier frequency without degrading stability and spectral purity with frequency synthesis. Finer-tuning is possible at a minimum cost in terms of stability and spectral purity.

On the following figure is represented a typical topology of an OEO with a 4 km fiber delay line.

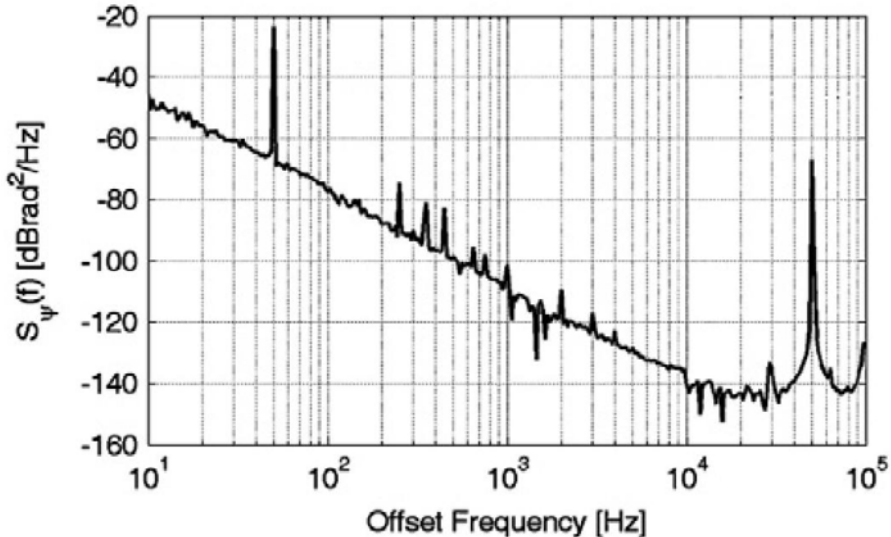

Fig. 2. Phase noise of an OEO realized at FEMTO-ST with a 4 km fiber delay line with a -145 dB.rad²/Hz noise floor at 10 kHz from a 10 GHz carrier

2. Examples of other topologies

With optical fiber several modes are in competitions. The use of two different loops enable elimination of parasitic peaks. For illustration, a simple topology with two loops is represented on figure 3. We design two optical ways detected by two different photo-detectors. We schematically present on figure 4 how one loop can filter the signal.

A new approach for the generation of ultralow jitter optical pulses using optoelectronic microwave oscillators was proposed. Short pulses are obtained through time-lens soliton-assisted compression of sinusoidally modulated pre-pulses, which are self-started from a conventional single-loop optoelectronic oscillator. The inherent ultra-low phase noise of optoelectronic oscillators is converted into ultra-low timing jitter for the generated pulses. Generation of 4.1 ps pulses along with a microwave whose phase noise is -140 dBc/Hz at 10 kHz from the 10 GHz carrier, with 2.7 fs jitter in the 1-10 kHz frequency band was demonstrated [6]. Figure 5 represents such topology with compression of impulsion.

6: Y. K. Chembo, A. Hmima, P. A. Lacourt, L. Larger and J. M. Dudley, „Generation of Ultralow Jitter Optical Pulses Using Optoelectronic Oscillators With Time-Lens Soliton-Assisted Compression,“ *J. of Lightwave Technology*, 27(22), 5160 – 5167 (2009)

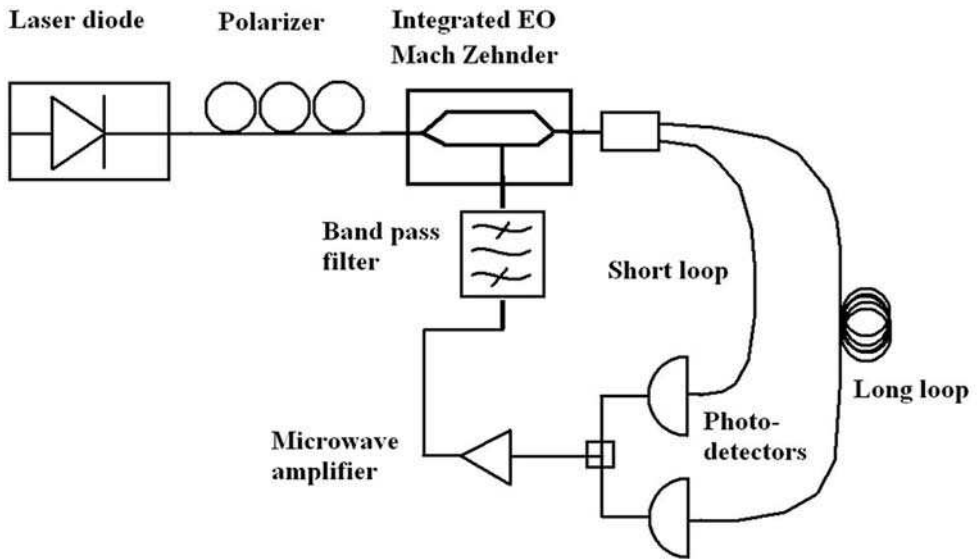

Fig. 3. Double loop topology of OEO

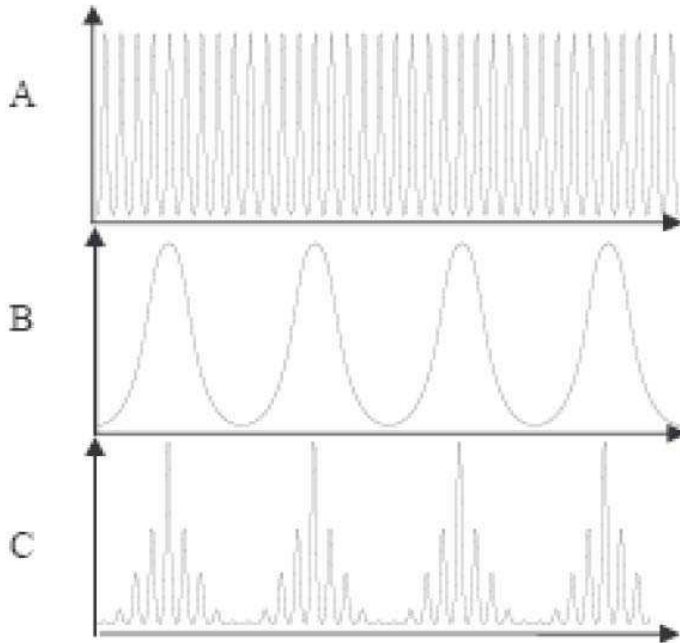

Fig. 4. A and B respectively represent long and short loops, one can see that peaks have been filtered in the sum, C signal. Amplitude is represented versus frequency

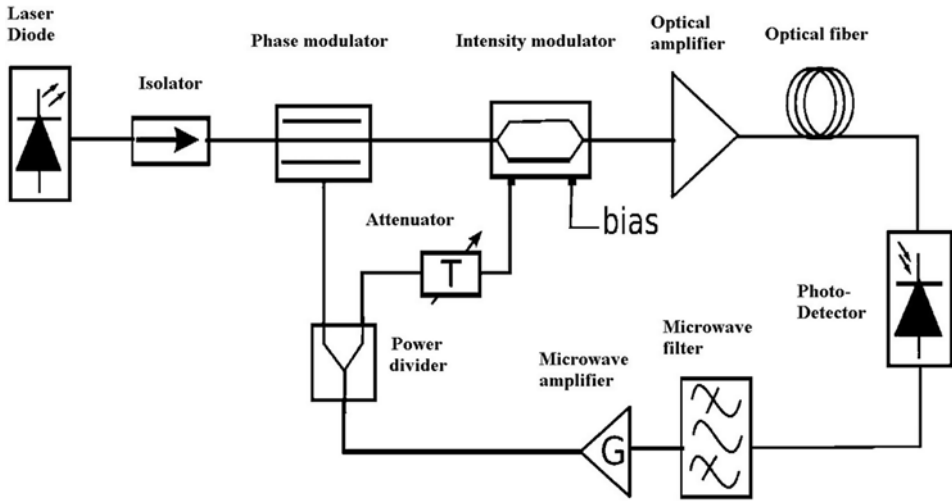

Fig. 5. Topology with compression of impulsion

3. Non linear approach for modelling the OEO

To study the behaviour of the system, a non linear approach was developed. It is based on complex equation for the delay. A Neimark-Sacker bifurcation was demonstrated and shown as a limitation for the performance of the system [7,8]. The possibility of multi-mode propagation according to the starting conditions of the oscillators was also demonstrated [9]. They were experimentally confirmed with a remarkable precision. These results established for the first time theoretical base of the spectral stability of the OEOs : noise floor and characterization of peaks.

4. Exploring the choice of compact resonators

It is interesting to integrate a compact resonator and forget a too long and temperature sensitive optical delay line. With its tetragonal crystal and a good behaviour with risk of water pollution, CaF₂ is a good candidate but it has a bad reaction to mechanical shocks. Resonators with MgF₂ and fused silica are still interesting for their properties [10,11]. MgF₂ can present low an inversion point around 80°C. Temperature variation of refractive index

7: Y. K. Chembo, L. Larger, H. Tavernier, R. Bendoula, E. Rubiola and P. Colet, „Dynamic instabilities of microwaves generated with optoelectronic oscillators,” *Optics Letters*, 32(17), 2571 (2007)

8: Y. K. Chembo, L. Larger and P. Colet, „Non linear dynamics and spectral stability of optoelectronic microwave oscillators,” *IEEE J. Quantum Electron.*, 44(9), 858 (2008)

9: Y. K. Chembo, L. Larger, R. Bendoula and P. Colet, „Effect of gain and bandwidth on the multimode behaviour of optoelectronic microwave oscillators,” *Optics Express*, 16(12), 9067 (2008)

10: P. Salzenstein, H. Tavernier, K. Volyanskiy, N. N. T. Kim, L. Larger, E. Rubiola, "Optical Mini-disk resonator integrated into a compact optoelectronic oscillator," *Acta Phys. Pol. A* 116(4), 661-663 (2009)

11: H. Tavernier, P. Salzenstein, K. Volyanskiy, Y. K. Chembo and L. Larger, „Magnesium Fluoride Whispering Gallery Mode Disk-Resonators for Microwave Photonics Applications,” *IEEE Photonics Technology Letters*, 22(22), 1629-1631 (2010)

dn_e/dT of MgF_2 is around zero in the range of $80^\circ C$ (positive at lower temperatures and negative at upper temperatures). It is particularly helpful to achieve stable oscillators as a precise control of the temperature is a quasi-necessary condition to reach high stabilities. Hardness of MgF_2 and CaF_2 is in the range of 6 Mohs and they have both good answer to mechanical shocks that makes less difficult fabrication of mini-disk with these materials. Their crystal class is very different as MgF_2 crystal is tetragonal and fused silica is non crystalline, and if MgF_2 is not sensitive to water pollution, it is necessary to have special treatments to minimize H_2O inclusion in fused silica [12]. These two materials are relatively easy to manipulate without damaging the surface. A special equipment must be developed for manufacturing resonator. A dedicated polishing machine affords small eccentricity and a precision adapter. System is held on air bearing support to mechanically prevent influence of vibration on the surface of the external toric surface of the mini-disk resonator. Process is started from an initial crystal optical windows of about 6 mm diameter and $500\ \mu m$ thickness for X-band applications. The coupling zone has to be reduced to less than $50\ \mu m$, that's why two 20 degrees angle bevels can be performed on the disk to form a sharp edge. We need a very good optical quality with very low and regular roughness all around the torical surface of the disk periphery. Powders with decreasing grain size are used. One can also achieve spheric resonators from electric flash in a fiber to perform spheric profile. Some methods exist to choose similar diameters for microspheres, based on the choice of similar diameters in the used powder. Advantage of spheres is to be free with polishing process, one disadvantage consist in the dispersion in the periphery, and difficulty to evacuate temperature.

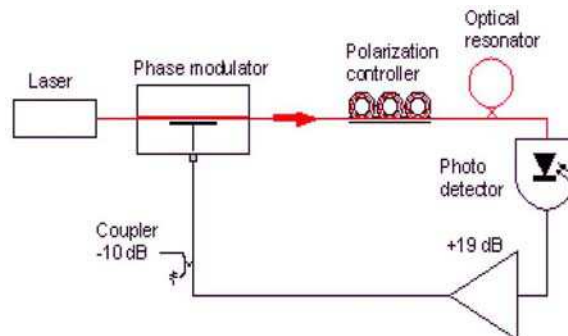

Fig. 6. Typical architecture of an optical resonator based OEO realized at FEMTO-ST institute

In order to introduce into the loop the fabricated resonator, it has to be coupled to the optical light coming from a fiber. Best way to couple is certainly to use a cut optical fibre through a prism. But a good reproducible way in a lab is to use a tapered fiber glued on a holder. Holder alloy and geometry match the thermal expansion of the glass.

For measuring the resonance [13], one uses the signal from a tunable laser diode. Fast digital real time oscilloscope permits the analysis of the very sharp phenomena at peak resonance.

¹²: V. G. Plotnichenko, V. O. Sokolov, and E. M. Dianov, "Hydroxyl Groups in High-Purity Silica Glass," *Inorganic Materials*, 36(4), 404-410 (2000)

¹³: H. Tavernier, N. N. T. Kim, P. Feron, R. Bendoula, P. Salzenstein, E. Rubiola, L. Larger, "Optical disk resonators with micro-wave free spectral range for optoelectronic oscillator," Proc. of the 22nd European Time and Frequency Forum - Toulouse, France, paper FPE-0179 (2008)

It is necessary to use a high speed resolution oscilloscope for the analysis of very short phenomena. Oscilloscope is inserted after the photodiode that detects optical signal coming from the mini-disk resonator coupled to the fibre glued on the holder. Resonance peak detection is in single mode excitation. Small taper size selects a thin excitation area. Resonance measurement set-up is in open loop. Although wavelength span is too small to scan a full free spectral range (FSR) and scan rate is 50 Hz, it let be possible Q factor measure with the self homodyne methodology [14]. Optical resonator is then inserted in the loop of the OEO as schematically represented on figure 6. Inside the optical resonator, light propagates with Whispering Gallery Modes (WGM) and the difference of optical index between the optical cavity and air permits a quasi total reflection of the signal inside the resonator, even if it depends on the roughness of the surface that also causes losses. OEO consists in a classic architecture. Phase modulator is optically driven by the laser. The optical mini-resonator is coupled to the optical fibre at the output of the phase modulator. Microwave signal is then amplified after being detected in the photodiode. Modulation microwave signal of the light comes from the output of the microwave amplifier through a directional coupler.

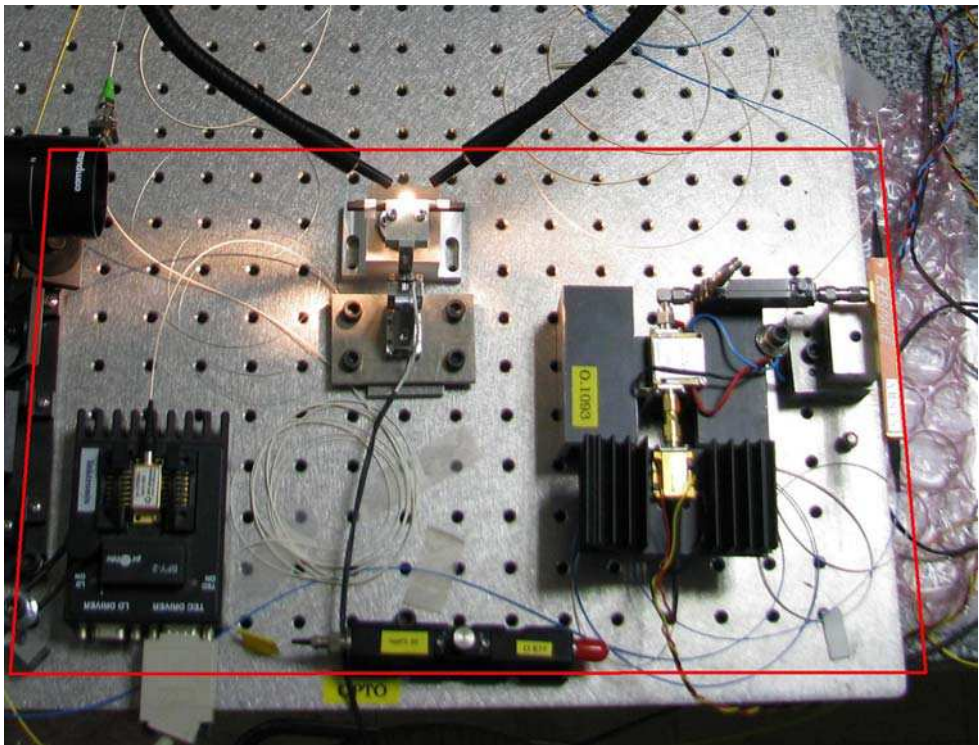

Fig. 7. Photography of an optical resonator based OEO realized at FEMTO-ST institute. The rectangle represents A3 format (297x420mm²)

¹⁴: J. Poirson, F. Bretenaker, M. Vallet, A. Le Floch, " Analytical and experimental study of ringing effects in a Fabry–Perot cavity. Application to the measurement of high finesses," J. Opt. Soc. Am. B 14(11), 2811-2817 (1997)

Figure 7 show an OEO with a compact mini-disk optical resonator. We clearly see the positioning system which combines the tapered fiber and the mini-resonator. Resonator coupled to the optic fiber can be seen at the top of the picture. It is under light in order to focus the camera (left top edge of the picture) on the coupling zone to watch on the screen of a camera-connected computer how closed is the fiber from the resonator. The nano-positioning system provides enough space for the moves in a $12 \times 12 \times 12$ mm³ typically volume and is controlled by a joystick including three different speeds to approach the resonator and the selected tapered fiber.

Optical mini-disk resonator helps to increase reduction of the dimension of OEO. Structure could be optimized by the use of a several meters long fiber loop in addition to the optical mini-disk. It could be interesting to work at higher frequencies than in X-band. Working at upper frequencies (20 GHz, 60 GHz or more) could be helpful to achieve a better frequency stability close to the carrier, even if it is too early to think that OEO could replace stable quartz oscillators. By the way OEO with fiber delay line are still promising for such applications. Optical resonators can be good candidate for several connected applications like filtering the frequency, generation of frequency, non linear functions like optical modulator at higher frequencies, use of combs of modes etc. Optical resonators based OEO can also be improved by stabilization of Laser signal and control of the polarization.

5. Measuring performances of an OEO

To measure phase noise of a unique OEO at Fourier frequencies between 10 Hz and 100 kHz from the carrier using dedicated optoelectronic phase noise measurement bench [15] because it cannot be locked on another if there is not the same exact frequency. State-of-the art OEO in terms of phase noise are presently manufactured in the USA [16]. Fused Silica micro-sphere resonators were already previously fabricated [17] and integrated into OEO. Recently, fused silica compact mini-disk optical resonators were also integrated into an OEO and it was demonstrated a upper phase noise floor [18]. The used fused silica resonator had a quality factor in the range of 10^8 . In order to generate microwave signal in X-band (8.2-12.4 GHz), diameter is in the range of 5 mm and quality of the surface less than few nanometres. Performance in terms of phase noise is certainly lower for an OEO based on compact optical resonator, but a large reduction of the noise should be possible with well optimized coupling conditions and thermal and mechanical environment of the resonator perfectly controlled. Stabilization of the laser on the resonance can be improved by the use of a Pound driver.

¹⁵: P. Salzenstein, J. Cussey, X. Jouvenceau, H. Tavernier, L. Larger, E. Rubiola, G. Sauvage, "Realization of a Phase Noise Measurement Bench Using Cross Correlation and Double Optical Delay Line," *Acta Physica Polonica A*, 112(5), 1107-1111 (2007)

¹⁶: V. S. Ilchenko, A. A. Savchenkov, A. B. Matsko, D. Seidel, L. Maleki, "Crystalline resonators add properties to photonic devices," 17 February 2010, SPIE Newsroom. DOI: 10.1117/2.1201002.002536 (2010)

¹⁷: V. S. Ilchenko, X. S. Yao, and L. e Maleki, "High-Q microsphere cavity for laser stabilization and optoelectronic microwave oscillator," *Proc. SPIE*, 3611, 190 (1999)

¹⁸: K. Volyanskiy, P. Salzenstein, H. Tavernier, M. Pogurmirskiy, Y. K. Chembo and L. Larger, "Compact Optoelectronic Microwave Oscillators using Ultra-High Q Whispering Gallery Mode Disk-Resonators and Phase Modulation," *Optics Express*, 18(21), 22358-22363 (2010)

6. Conclusion

OEO is a particularly interesting system to be studied for fundamental physics with its complex system with delay, but also for its applications. Several aspects already have been explored and its performances help in understanding this system. It should probably play a major role in the future especially for new generation navigation system applications. Several fields are still open in research, especially by considering new complex architectures regarding existing architectures. One contribution should help with a different approach than usual, i. e. stochastic and non-linear dynamic systems.

7. Acknowledgement

The author acknowledges Dr. Yanne K. Chembo (CNRS researcher, FEMTO-ST, Besançon) and Hervé Tavernier (PhD student, FEMTO-ST, Besançon) for helpful discussions.

8. References

- Y. K. Chembo, L. Larger, H. Tavernier, R. Bendoula, E. Rubiola and P. Colet, Dynamic instabilities of microwaves generated with optoelectronic oscillators, *Optics Letters*, 32(17), 2571 (2007)
- Y. K. Chembo, L. Larger and P. Colet, Non linear dynamics and spectral stability of optoelectronic microwave oscillators, *IEEE J. Quantum Electron.*, 44(9), 858 (2008)
- Y. K. Chembo, L. Larger, R. Bendoula and P. Colet, Effect of gain and bandwidth on the multimode behaviour of optoelectronic microwave oscillators, *Optics Express*, 16(12), 9067 (2008)
- Y. K. Chembo, A. Hmima, P. A. Lacourt, L. Larger and J. M. Dudley, Generation of Ultralow Jitter Optical Pulses Using Optoelectronic Oscillators With Time-Lens Soliton-Assisted Compression, *J. of Lightwave Technology*, 27(22), 5160 – 5167 (2009)
- I. S. Grudin, V. S. Ilchenko, L. Maleki, Ultrahigh optical Q factors of crystalline resonators in the linear regime, *Phys. Rev. A* 74, 063806(9) (2006)
- V. S. Ilchenko, A. A. Savchenkov, A. B. Matsko, D. Seidel, L. Maleki, Crystalline resonators add properties to photonic devices, 17 February 2010, *SPIE Newsroom*. DOI: 10.1117/2.1201002.002536 (2010)
- V. S. Ilchenko, X. S. Yao, and L. e Maleki, High-Q microsphere cavity for laser stabilization and optoelectronic microwave oscillator, *Proc. SPIE*, 3611, 190 (1999)
- A. Neyer, E. Voges, High frequency electro optic oscillator using an integrated interferometer, *Appl. Phys. Lett.* 40(1), 6-8 (1982)
- J. Poirson, F. Bretenaker, M. Vallet, A. Le Floch, Analytical and experimental study of ringing effects in a Fabry-Perot cavity. Application to the measurement of high finesse, *J. Opt. Soc. Am. B* 14(11), 2811-2817 (1997)
- V. G. Plotnichenko, V. O. Sokolov, and E. M. Dianov, Hydroxyl Groups in High-Purity Silica Glass, *Inorganic Materials*, 36(4), 404-410 (2000)
- P. Salzenstein, J. Cussey, X. Jouvenceau, H. Tavernier, L. Larger, E. Rubiola, G. Sauvage, Realization of a Phase Noise Measurement Bench Using Cross Correlation and Double Optical Delay Line, *Acta Physica Polonica A*, 112(5), 1107-1111 (2007)

- P. Salzenstein, H. Tavernier, K. Volyanskiy, N. N. T. Kim, L. Larger, E. Rubiola, Optical Mini-disk resonator integrated into a compact optoelectronic oscillator, *Acta Phys. Pol. A* 116(4), 661-663 (2009)
- H. Tavernier, N. N. T. Kim, P. Feron, R. Bendoula, P. Salzenstein, E. Rubiola, L. Larger, Optical disk resonators with micro-wave free spectral range for optoelectronic oscillator, *Proc. of the 22nd European Time and Frequency Forum - Toulouse, France*, paper FPE-0179 (2008)
- H. Tavernier, P. Salzenstein, K. Volyanskiy, Y. K. Chembo and L. Larger, Magnesium Fluoride Whispering Gallery Mode Disk-Resonators for Microwave Photonics Applications, *IEEE Photonics Technology Letters*, 22(22), 1629-1631 (2010)
- K. Volyanskiy, J. Cussey, H. Tavernier, P. Salzenstein, G. Sauvage, L. Larger, and E. Rubiola, Applications of the optical fiber to the generation and measurement of low-phase-noise microwave signals, *J. Opt. Soc. Am. B* 25(12), 2140-2150 (2008)
- K. Volyanskiy, P. Salzenstein, H. Tavernier, M. Pogurmirskiy, Y. K. Chembo and L. Larger, Compact Optoelectronic Microwave Oscillators using Ultra-High Q Whispering Gallery Mode Disk-Resonators and Phase Modulation, *Optics Express*, 18(21), 22358-22363 (2010)
- X. S. Yao and L. Maleki, High frequency optical subcarrier generator, *Electronics Letters*, 30(18), 1525 (1994)
- X. S. Yao, L. Maleki, Optoelectronic microwave oscillator, *J. Opt. Soc. Am. B* 13(8), 1725-1735 (1996)

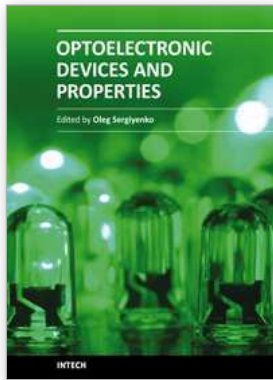

Optoelectronic Devices and Properties

Edited by Prof. Oleg Sergiyenko

ISBN 978-953-307-204-3

Hard cover, 660 pages

Publisher InTech

Published online 19, April, 2011

Published in print edition April, 2011

Optoelectronic devices impact many areas of society, from simple household appliances and multimedia systems to communications, computing, spatial scanning, optical monitoring, 3D measurements and medical instruments. This is the most complete book about optoelectromechanic systems and semiconductor optoelectronic devices; it provides an accessible, well-organized overview of optoelectronic devices and properties that emphasizes basic principles.

How to reference

In order to correctly reference this scholarly work, feel free to copy and paste the following:

Patrice Salzenstein (2011). Optoelectronic Oscillators, Optoelectronic Devices and Properties, Prof. Oleg Sergiyenko (Ed.), ISBN: 978-953-307-204-3, InTech, Available from:

<http://www.intechopen.com/books/optoelectronic-devices-and-properties/optoelectronic-oscillators>

INTECH

open science | open minds

InTech Europe

University Campus STeP Ri
Slavka Krautzeka 83/A
51000 Rijeka, Croatia
Phone: +385 (51) 770 447
Fax: +385 (51) 686 166
www.intechopen.com

InTech China

Unit 405, Office Block, Hotel Equatorial Shanghai
No.65, Yan An Road (West), Shanghai, 200040, China
中国上海市延安西路65号上海国际贵都大饭店办公楼405单元
Phone: +86-21-62489820
Fax: +86-21-62489821

© 2011 The Author(s). Licensee IntechOpen. This chapter is distributed under the terms of the [Creative Commons Attribution-NonCommercial-ShareAlike-3.0 License](#), which permits use, distribution and reproduction for non-commercial purposes, provided the original is properly cited and derivative works building on this content are distributed under the same license.