

Fault-Tolerance of a Transport Aircraft with Adaptive Control and Optimal Command Allocation

Federico Corraro, Gianfranco Morani and Adolfo Sollazzo
Italian Aerospace Research Centre (CIRA)
Italy

1. Introduction

How to achieve high performance and reliability against various unforeseen events, uncertainties and other changes in plant dynamics has been a very challenging issue for control system design in recent years. Reconfigurable flight controls aim to guarantee greater survivability in all the cases in which the systems to be controlled may be poorly modelled or the parameters of the systems may be subjected to large variations with respect to the operating environment. A suitable approach to the problem of flight control reconfiguration consists in redesigning its own structure and/or re-computing control gains in the case of unexpected events or large model and environmental uncertainties. A number of different approaches have been proposed and developed in the past years (Patton, 1997). In this chapter a Direct Adaptive Model Following (DAMF) algorithm has been used for reconfiguration purposes. It is possible to find in literature a great amount of proposed techniques to implement (Bodson & Groszkiewicz, 1997; Calise et al., 2001; Boskovic & Mehra, 2002; Kim et al., 2003; Tandale & Valasek, 2003). The Lyapunov theory described in (Kim et al., 2003; Tandale & Valasek, 2003) has very attractive features both in terms of effectiveness and implementation and it has been used to develop the fault-tolerant scheme described in this chapter.

Another important matter in flight control reconfiguration is the Control Allocation (CA) problem. It concerns the possibility to exploit actuators redundancy with respect to the variables to be controlled in order to redistribute the control effort among the available control effectors. In this way the control commands needed to attain the desired moments can be computed even in presence of actuator failures, while also dealing with position and rate limits of the control effectors. A great amount of techniques for control allocation are available in literature (Virnig & Bodden, 2000; Enns, 1998; Buffington & Chandler, 1998; Durham & Bordignon, 1995; Burken et al., 2001). The technique used in this chapter is the one introduced by Harkegard (Harkegard, 2002) based on active set methods, which is very effective for real-time applications and converge in a finite number of steps.

Therefore in this chapter a scheme of a fault-tolerant flight control system is proposed. It is composed by the core control laws, based on the DAMF technique, to achieve both robustness and reconfiguration capabilities, and the CA system, based on the active set method, to properly allocate the control effort on the healthy actuators. Numerical results of

a case study with a detailed model of a large transport aircraft are reported to show the effectiveness of the proposed fault-tolerant control scheme.

The chapter is organized as follows. Sec. 2 explains the proposed flight control system architecture and all its features. Sec. 3 and 4 report detailed descriptions of each element composing the Flight Control System (FCS). Sec. 5 contains the most meaningful results of the numerical evaluation. Finally, Sec. 6 reports the main outcomes and the conclusions about the current results of the research project.

2. The fault-tolerant flight controller scheme

The logical scheme of the full fault-tolerant flight controller is reported in Fig. 1. The picture shows four main elements, the autopilot (A/P), the actuators health monitor, the Stability and Controllability Augmentation System (SCAS), based on the DAMF, and the Control Allocation module. The last two elements represent the Fault-Tolerant Control System (FTCS) that is the object of this chapter.

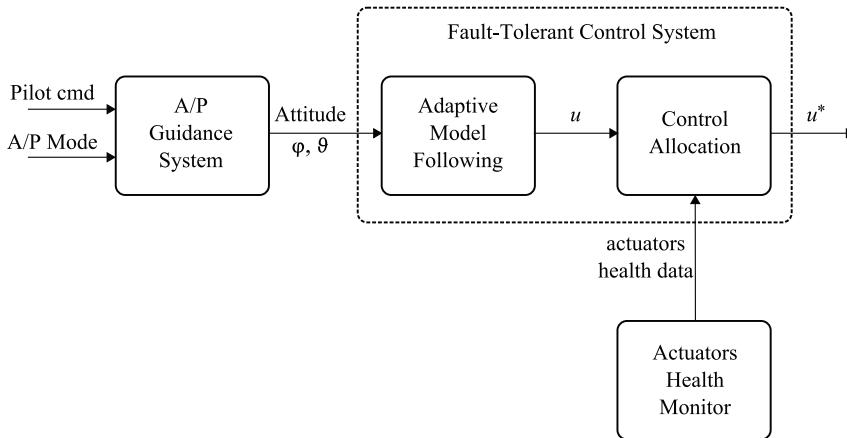

Fig. 1. The first layer scheme of the full Flight Control System

Although adaptive control exhibits great reconfiguration capabilities, in case of in-flight faults, abrupt and dramatic changes in control effectiveness and/or plant dynamics may occur, such that the adaptive controller may not be able to recover the vehicle. Therefore, an adaptive controller could take advantage of a control allocation module to ensure the generation of the demanded moments by the optimal control system, both in healthy and faulty conditions of the actuation system.

The remaining two elements are not the focus of this work and they are developed with classic techniques. In details, the A/P is designed by means of the classic sequential loop closures, implementing the typical guidance modes for the aircraft (see Table. 1).

<i>Longitudinal</i>	<i>Lateral</i>
Altitude Hold/Select	Heading Hold/Select
GlideSlope Intercept	Localizer Intercept
Approach Lon	Approach Lat

Table 1. List of Autopilot modes

Also the health monitoring of actuators is a very trivial system based on the comparison between the input and the output of each actuators. In the numerical validation it is supposed to use a monitoring system with the capability to detect an actuator fault within 10 seconds, and to pass the binary information healthy/faulty to the control allocation system. In the following two sections the elements of the FTCS are briefly recalled.

3. Adaptive control system

The core module of the whole flight control system is the SCAS that is in charge of guaranteeing vehicle attitude control and stability. As already said, the proposed algorithm for this module has been designed using a Direct Adaptive Model-Following method (Boskovic & Mehra, 2002; Kim et al., 2003; Tandale & Valasek, 2003), having the advantage of strong robustness against model parameter uncertainty, and a good capability of reacting to system parameters' variation. Moreover, the model following strategy lets the designer to define in a clear and simple way the reference dynamics for the system, thus making this control strategy very attractive among other available robust control techniques. In the following some recalls about the DAMF are given.

3.1 Theoretical recalls

DAMF is a Model Reference Control Strategies and it earns its robustness properties by means of a direct adaptation of control loop gains to asymptotically reach two objectives. The first is a null error between the output of the reference model and the one of real plant. The second objective is to minimize the control effort. As already said, the proposed adaptation algorithm is based on the Lyapunov theory. A mathematical description of the method, fully reported in (Kim et al., 2003), follows. Let us consider the linear model of a plant:

$$\begin{aligned} \dot{x} &= Ax + Bu + d \\ y &= Cx \end{aligned} \tag{1}$$

with $x \in \mathbb{R}^n$ the state vector, $y \in \mathbb{R}^l$ the output vector, $u \in \mathbb{R}^m$ the control vector, $A \in \mathbb{R}^{n \times n}$, $B \in \mathbb{R}^{n \times m}$, $C \in \mathbb{R}^{l \times n}$ and the term d represents the trim data. The reference system dynamics is written in term of desired input-output behaviour:

$$\dot{y}_m = A_m y_m + B_m r \tag{2}$$

where y_m is the desired output for the plant, r is the given demand, A_m and B_m represent the reference linear system. The control laws structure is defined as follows:

$$u = C_0 (G_0 x + v + r + K_0 y_m) \tag{3}$$

where G_0 , C_0 and v are proper terms generated by the adaptation rules, instead K_0 is a feed-forward gain matrix off-line computed. It is now possible to calculate the error function as follows:

$$e = y - y_m \tag{4}$$

and to evaluate the error dynamics, in terms of the plant parameters and the reference system dynamics:

$$\dot{e} = (CA + CBC_0G_0)x + CBC_0r + CBC_0v + CBC_0K_0y_m + Cd - A_my_m - B_mr \quad (5)$$

Assuming a desired error system dynamics, expressed as:

$$\dot{e} = A_e e + \Phi \quad (6)$$

where A_e is a stable and properly chosen matrix, and Φ represents a bounded forcing function, it is possible to write the following identities:

$$\begin{aligned} CA + CBC_0^*G_0^* &= A_e C \\ CBC_0^* &= B_m \\ CBC_0^*v^* &= -Cd \\ CBC_0^*K_0 &= A_m - A_e \end{aligned} \quad (7)$$

Equations 7 allow to write the expressions of the optimal terms G_0^* , C_0^* , v^* and K_0 to obtain a perfect model inversion that guarantees the asymptotical stability of the closed loop system and the asymptotical null error.

$$\begin{aligned} G_0^* &= B_m^{-1}(A_e C - CA) \\ C_0^* &= (CB)^{-1}B_m \\ v^* &= -B_m^{-1}Cd \\ K_0 &= B_m^{-1}(A_m - A_e) \end{aligned} \quad (8)$$

In order to evaluate the left hand terms (the gains of the controller), Equations 8 require matrix B_m to be invertible and CB matrix to be pseudo-invertible. While the former is a design parameter, the latter, called high frequency gain, is a structural characteristic of the plant. Anyway, modern aircrafts have typically a sufficient redundancy order for the control surfaces, thus ensuring not to lose rank order even in the case of single and often double actuators failure. Concerning the C matrix, no sensor failure cases are addressed in this chapter, anyway the device redundancy or several techniques, available in literature (f.i. Kalman filtering), may ensure a full state feedback, even though each signal may lose accuracy in case of sensor failure.

It should be anyway noted that the control parameters of Equation 8 do not take into account the system parameters variation. However, the system parameters uncertainties can be modelled by a proper variation of the matrices in Equation 1. Finally, a set of adaptation rules is necessary to react to the system parameters variation and uncertainty, Lyapunov theory furnishes a very efficient solution. First of all, let us define the differences between the actual adaptive parameters and the optimal ones:

$$\begin{aligned} \Delta G &= G_0 - G_0^* \\ \Delta \Psi &= C_0^{*-1} - C_0^{-1} \\ \Delta v &= v_0 - v_0^* \end{aligned} \quad (9)$$

After some manipulations (Kim et al., 2003), here left out for the sake of brevity, it is now possible to write the real expression of the error dynamics taking into account a parameters variation:

$$\dot{e} = A_e e + B_m \Delta G \cdot x + B_m \Delta \Psi \cdot u + B_m \Delta v \tag{10}$$

It is allowed to impose the Lyapunov stability condition for the error system. So, let us consider the Lyapunov candidate function:

$$V = e^T P e + tr \left\{ \frac{\Delta G^T \Delta G}{\gamma_1} \right\} + tr \left\{ \frac{\Delta \Psi^T \Delta \Psi}{\gamma_2} \right\} + \frac{\Delta v^T \Delta v}{\gamma_3} \tag{11}$$

where P is the matrix solution of Lyapunov equation:

$$A_e^T P + P A_e = -Q \tag{12}$$

with Q is a positive definite weighting matrix. By calculating the time derivative of the Lyapunov candidate function and by casting it to get null, the following conditions can be found, that represent the adaptation rules for the control laws parameters.

$$\begin{aligned} \dot{G}_0 &= -\gamma_1 B_m^T P e x^T \\ \dot{C}_0 &= -\gamma_2 C_0 B_m^T P e u^T C_0 \\ \dot{v}_0 &= -\gamma_3 B_m^T P e \end{aligned} \tag{13}$$

Moreover by taking into account the Equations 10, 11 and 13 it is possible to demonstrate the non-positiveness of Lyapunov candidate function derivative:

$$\dot{V} = -e^T P e \leq 0 \tag{14}$$

which assures the asymptotical stability for the error dynamic system.

3.2 Implementation of the SCAS module

The SCAS module is made of two nested sub-modules, taking advantage of the dynamics separation principle, being the angular rate dynamics sufficiently faster than those of the attitude ones. This two modules architecture also leads to a relevant reduction of the overall complexity (in terms of states number) of the adaptive algorithm. The detailed structure of each Multi Input Multi Output (MIMO) controller is reported in Fig. 2. The design of both inner and outer loops consists in tuning some parameters. First of all, the matrices A_m and B_m , representing the dynamics of the Reference Model, must be selected with the limitation that the former must trivially be chosen with negative eigenvalues and the latter must be chosen invertible. These two matrices actually define the control system performance requirements. For both attitude and rates regulators, a couple of very simple reference models made of two diagonal systems (1st order and decoupled systems) have been chosen. The desired error dynamics are chosen through the matrix A_e by which, it is also possible to modify the system capability to reject noise and disturbances.

The matrix Q , used in the Equation 12 for the calculation of P , has the meaning of a weighting matrix. By fine tuning this matrix, it is possible to give more or less relevance to the tracking requirement of one or more output variables with respect to the others. Finally, the three parameters γ_1 , γ_2 and γ_3 (evaluated by means of a trial and error procedure) are used to regulate the adaptive capability. As a reminder, in Table 2 all the design parameters are reported.

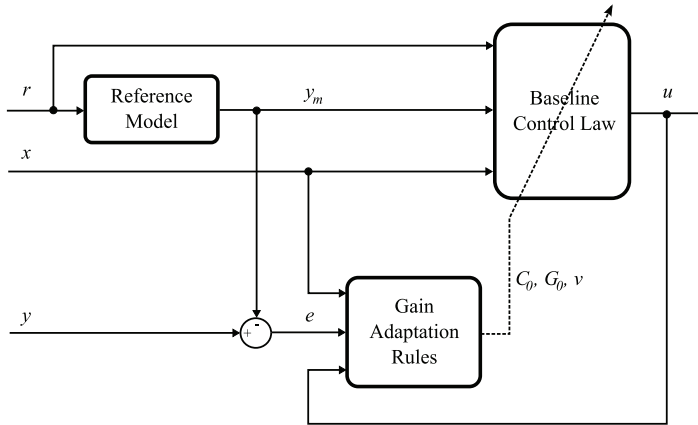

Fig. 2. SCAS sub-module logical architecture

	A_m, B_m	A_e	Q	$\gamma_1, \gamma_2, \gamma_3$
Inner Loops	$\begin{bmatrix} -1 & 0 & 0 \\ 0 & -1 & 0 \\ 0 & 0 & -1 \end{bmatrix} \begin{bmatrix} 1 & 0 & 0 \\ 0 & 1 & 0 \\ 0 & 0 & 1 \end{bmatrix}$	$\begin{bmatrix} -45 & 0 & 0 \\ 0 & -45 & 0 \\ 0 & 0 & -45 \end{bmatrix}$	$\begin{bmatrix} 0.8 & 0 & 0 \\ 0 & 1.2 & 0 \\ 0 & 0 & 1 \end{bmatrix}$	$\begin{bmatrix} 0.06 \\ 0.1 \\ 0.1 \end{bmatrix}$
Outer Loops	$\begin{bmatrix} -0.5 & 0 \\ 0 & -0.5 \end{bmatrix} \begin{bmatrix} 0.5 & 0 \\ 0 & 0.5 \end{bmatrix}$	$\begin{bmatrix} -1.5 & 0 \\ 0 & -0.75 \end{bmatrix}$	$\begin{bmatrix} 1 & 0 \\ 0 & 0.5 \end{bmatrix}$	$\begin{bmatrix} 0.01 \\ 0.01 \\ 0.2 \end{bmatrix}$

Table 2. SCAS module parameters

4. The control allocation module

As mentioned in the introduction a control allocation algorithm can be very useful for control reconfiguration purposes due to its ability of managing actuator redundancy, so to redistribute control effort after a failure event. Moreover, it may be a great support for an optimal control strategy, such as the DAMF that works well in the case of limited faults (i.e. the plant dynamics do not change dramatically) and in any case it does not take into account the limited range and limited rate of the control variables.

4.1 Theoretical background

In this section the control allocation problem is briefly introduced. Given a control vector $u_p \in \mathfrak{R}^m$ as computed by the control system (see Equation 3), a desired moment vector $v_{des} \in \mathfrak{R}^l$ can be defined as:

$$v_{des} = CBu_p \tag{15}$$

where the matrix product CB is the high frequency gain of the healthy system (no faults). In the event of one or more faults, system defined in Equation 1 becomes:

$$\begin{aligned} \dot{x} &= Ax + B_{fault}u + Bu_{lock} + d \\ y &= Cx \end{aligned} \tag{16}$$

where B_{fault} is the control matrix of the failed plant which can be expressed as:

$$B_{fault} = B\Pi \tag{17}$$

where Π is a diagonal matrix with the elements $\pi_i = 0$ for i -th actuator failed and $\pi_i = 1$ for a healthy actuator. This matrix accounts for the fact that failed actuators cannot be used anymore to change the system’s dynamics. The term Bu_{lock} accounts for a residual moment due to an actuator locked in a fixed position, so we set $u_{lock}(j) = 0$ if j -th actuator is healthy and $u_{lock}(j) = u_j$ if j -th actuator is locked at u_j . After this setting, the residual moment to be attained by the failed system is defined as

$$\Delta v = v_{des} - CBu_{lock} \tag{18}$$

which is the moment to be attained with the *failed* high frequency gain matrix B_{fault} . Therefore the goal of control allocation is to find a control $\tilde{u} \in \mathfrak{R}^m$ such that $CB_{fault}\tilde{u} = \Delta v$. The new control vector shall also satisfy the constraints on maximum and minimum values, which can be computed at each instant depending on the actual position and rate limits, that is, $u_{min} \leq \tilde{u} \leq u_{max}$.

Generally speaking a solution to the above problem may not exist or it may be not unique depending on the rank of matrix CB_{fault} . If there are more solutions, the exceeding control authority can be exploited to choose the solution which is the nearest to a reference control vector $u_p \in \mathfrak{R}^m$ (for example the one computed by the control system). A common approach to solve the control allocation problem is based on the following weighted least square formulation (Harkegard, 2002):

$$u_w = \min_{u_{min} \leq u \leq u_{max}} \left\| W_u (u - u_p) \right\|^2 + \gamma \left\| W_v (CB_{fault}u - \Delta v) \right\|^2 \tag{19}$$

where $\|\cdot\|^2$ is the L_2 -norm, u_p is a reference control vector, W_u and W_v are non-singular weighting matrices. The first term of the above minimization problem allows to choose, among all the feasible control vectors which minimize the L_2 -norm of the error $CB_{fault}u - \Delta v$, the one minimizing the norm of $(u - u_p)$. The weighting factor γ defines the relative degree of importance between the moments error $CB_{fault}u - \Delta v$ and the control error $(u - u_p)$. Obviously γ should be chosen large enough to ensure the minimization of the error in attaining the desired moments.

In this chapter we will address the problem of control allocation with the use of a technique based on the active set method and described in (Harkegard, 2002). Active set methods are very common in constrained quadratic programming. They only consider active constraints (equality constraints) and disregard inactive constraints. Therefore active set algorithms move on the surface defined by the set of the active constraints (named Working Set) to get an improved solution. The working set is continuously updated during the execution of the algorithm. In fact, whenever a new constraint is violated, it is added to the current working set. On the other hand, if a feasible solution has been found by the algorithm, but a Lagrange multiplier related to the current working set is negative, the corresponding active constraint is dropped in order to get an improved solution. An exhaustive description of the

control allocation algorithm used in this chapter can be found in (Harkegard, 2002). Some recalls are given in the section below.

4.2 Control allocation algorithm

For each iteration step of the algorithm the following optimization problem is solved:

$$\min_p \|A(p + u_k) - b\|^2; \quad (20)$$

$$p_i = 0, \quad i \in W_k, \quad A = \begin{pmatrix} \mathcal{W}_v B \\ W_u \end{pmatrix}, \quad b = \begin{pmatrix} \mathcal{W}_v v \\ W_u u_p \end{pmatrix}$$

where u_k is the starting solution at the iteration step k , the set W_k is the current working set, that is, the set containing the active constraints (i.e. saturated controls) which are expressed through the equality $p_i=0$, while the remaining inequality constraints are disregarded.

Solution to the least square problem of Equation 21 consists of finding the optimal perturbation p which can be obtained by using a simple pseudo inversion method (Harkegard, 2002). Once the constraints on actuator limits have been set

$$Cu \geq U; \quad (21)$$

$$C = \begin{pmatrix} +I \\ -I \end{pmatrix}, \quad U = \begin{pmatrix} +u_{\max} \\ -u_{\min} \end{pmatrix}$$

($I^{m \times m}$ is the identity matrix), if the solution $u_k + p$ is feasible, the Lagrange multipliers λ_i associated with the active constraints are computed. If they are non-negative, the optimum solution is obtained otherwise the i -th constraint is dropped from the active set because a better solution can be found according to the meaning of Lagrange multipliers (Luenberger, 1989). In the case that $u_k + p$ is not feasible, the maximum step α is calculated such that $u_k + \alpha p$ is still feasible and a new constraint is added to the working set. This iterative procedure is then repeated until a suitable solution and a working set with negative related Lagrange multiplier are found.

4.3 Remarks

As above described control allocation algorithm has the aim of redistribute the control effort among the "healthy" surfaces to achieve the moments needed to keep the system along reference trajectory. In view of these considerations we argue that control allocation can be very useful, when used in conjunction with a direct adaptive control in those critical failure scenarios which can be hardly handled by the only use of the adaptive controller. Nevertheless, in order to be effective for reconfiguration purposes, control allocation needs a Fault Detection (FD) system, which gives information about the health of the surfaces' actuators. This aspect could make unfeasible the use of a CA scheme. Anyway, in the following sections it will be shown that, in order to obtain a satisfactory performance of the CA module, only limited failure information are needed. In fact, also a very simple monitoring algorithm, based on the actuator model and on the surface actual position, can be sufficient to establish whether an actuator is failed or not. The results show that the use of a CA scheme allows significant improvements of the control system performances also in the event of very critical failures and it only needs limited information about actuators'

health. These features make the proposed control architecture very appealing for reconfiguration purposes.

5. Numerical validation

The FCS has been applied in a case study with a large transport aircraft. The works has been performed within the GARTEUR Action Group 16, project focused on Fault-Tolerant Control. In that project a benchmark environment (Smaili et al., 2006) has been developed modelling a bunch of surface actuators faulty conditions. A brief summary of all these conditions is given in Table 3, while a detailed explanation of the benchmark can be found in (Smaili et al., 2006).

Several manoeuvres are considered in the benchmark to be accomplished in the various faulty conditions. The test results are here shown both in terms of time histories of the state variables and with a visual representation of the trajectories performed by the airplane.

Stuck Ailerons:

Both inboard and outboard ailerons are stuck.

Stuck Elevators:

Both inboard and outboard elevators are stuck.

Stabilizer Runaway:

The stabilizer goes at the maximum speed toward the maximum deflection.

Rudder Runaway:

The upper and lower rudders go at the maximum speed toward the maximum deflection.

Loss of Vertical Tail:

The vertical tail separates from the aircraft.

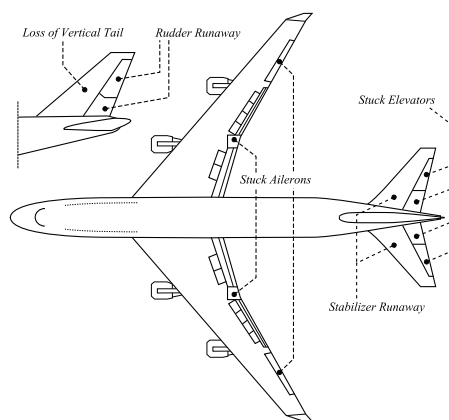

Table 3. Failures considered in the test campaign

Only the most meaningful conditions are here reported and discussed. To better demonstrate the improvement of fault-tolerance achieved by adopting the adaptive control in conjunction with the Control Allocation, comparison is made between three versions of the FCS, the first is a baseline SCAS developed with classic control techniques. The two remaining FCS are based on the adaptive SCAS with and without the CA respectively. As above said, only limited FD information are supposed to be provided, that is, the information about whether an actuator is failed or not but the current position of the failed actuator will be considered as unknown. The CA parameters have been set to:

$$\begin{aligned}
 \gamma &= 10^6 \\
 W_u &= I^{3 \times 3} \\
 W_v &= I^{3 \times 3}
 \end{aligned}
 \tag{22}$$

5.1 Straight flight with stabilizer failure

In this condition, while in straight and levelled flight, the aircraft experiences a stabilizer runaway to maximum deflection that generates a pitching down moment. The initial flight condition data are summarized in Table 4.

Altitude [m]	True Airspeed [m/s]	Heading [deg]	Mass [kg]	Flaps [deg]
600	92.6	180	263,000	20

Table 4. Flight condition data

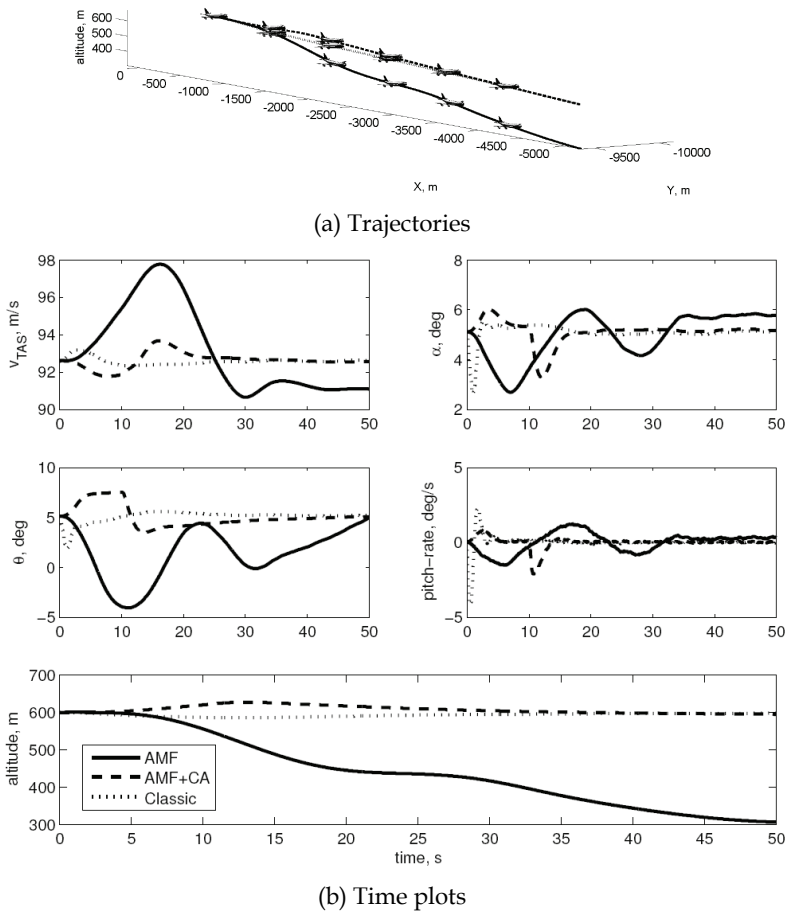

Fig. 3. Straight flight with stabilizer runaway with classic technique (dotted line), DAMF (solid line) and DAMF+CA (dashed line)

Fig. 3 (a) shows the great improvement achieved thanks to the adoption of the control allocation. Note that the classic technique, for this failure condition, shows adequate robustness. This is caused by its structure. In fact, the longitudinal control channel (PI for

pitch-angle above proportional pitch-rate SAS) affects only the elevators, while the stabilizer is supposed to be operated by the pilot separately. In this way, the stabilizer runaway results to be a strong, but manageable disturbance. Instead, the DAMF tries to recover the attitude lavishing stronger control effort on the faulty stabilizer, the most effective surface, with bad results. The awareness of the fault on the stabilizer gives the chance to the CA technique to compensate by moving the control effort from this surface to the elevators, thus achieving the same results of the classical technique. As it is also evident in the time plots of Fig. 3 (b) when the failure is detected and isolated (here it is supposed to be done in 10 sec after the failure occurs), the aircraft recovers a more adequate attitude to carry out properly the manoeuvre.

5.2 Right turn and localizer intercept with rudder runaway

This manoeuvre consists in the interception of the localizer beam, parallel to initial flight path, but opposite in versus. So, in the early stage of the manoeuvre, a right turn is performed, and then the capture and the tracking of the localizer beam are carried out. The fault, instead, consists in a runaway of both upper and lower rudder surfaces, so giving a strong yawing moment opposite to the desired turn. The initial flight condition data are summarized in Table 4.

In this failure case, a classical technique is totally inadequate to face such a failure, so leading the aircraft to crash into the ground. Instead, the DAMF shows to be robust enough to deal with this failure condition and it makes the aircraft to accomplish the manoeuvre, even though with reduced performance. The control allocation technique, instead, shows a sensible improvement of the robustness (see Fig. 4), if compared to the DAMF technique. The awareness of the fault (detected 10 sec after it actually occurs) allows the control laws to fully exploit all the efficient effectors, thus accomplishing the manoeuvre smoothly. It is worth noting that in this case the DAMF without CA is robust enough to accomplish the manoeuvre, even though with degraded performances.

5.3 Right turn and localizer intercept with loss of vertical tail

The manoeuvre, here considered, is the same described in the previous subsection, but the failure scenario consists in the loss of the vertical tail (Smaili et al., 2006). The initial flight condition data are summarized in Table 4. This is both a structural and actuation failure, in fact, the loss of the rudders strongly affects the lateral-directional aerodynamics and stability, compromising the possibility to damp the rotations about the roll and yaw axes. In this case (see Fig. 5), the classical technique is not able to reach lateral stability. Instead, no significant differences are evidenced between the two versions of the adaptive FCS (with and without CA). In fact, the information about the efficiency of the differential thrust is already available to the DAMF, due to the linear model of the bare Aircraft. Thus, as the tracking errors increase, the core control laws raise the control effort for both the rudders (failed) and the differential thrust. The latter is efficient enough to ensure the manoeuvrability.

6. Conclusions

In this chapter a fault-tolerant FCS architecture has been proposed. It exploits the main features of two different techniques, the adaptive control and the control allocation. The contemporaneous usage of these two techniques, the former for the robustness, and the latter for the explicit actuators failure treatment, has shown significant improvements in terms of fault-tolerance if compared to a simple classical controller and to the only adaptive

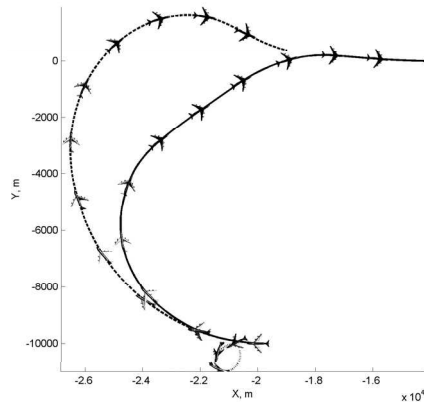

(a) Trajectories

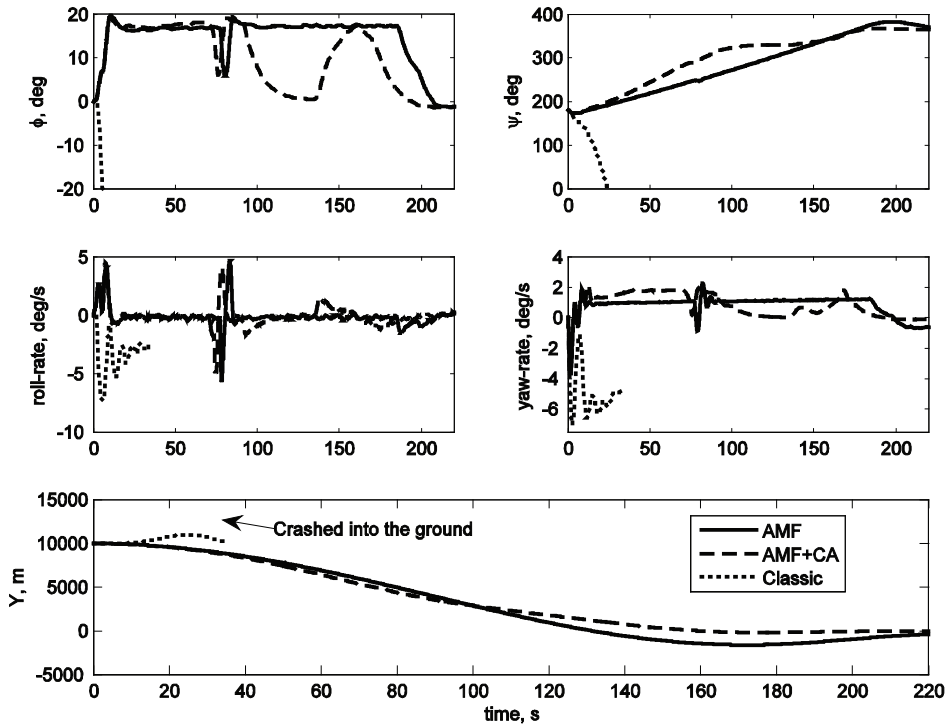

(b) Time plots

Fig. 4. Right turn and localizer intercept with rudder runaway with classic technique (dotted line), DAMF (solid line) and DAMF+CA (dashed line)

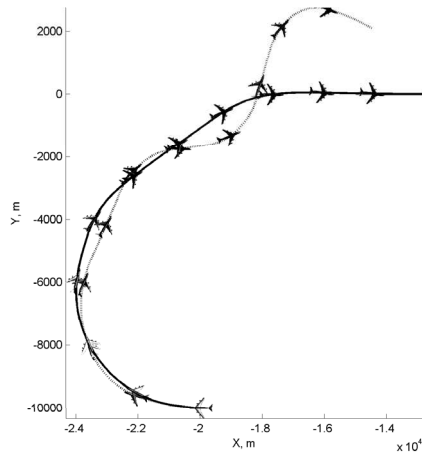

(a) Trajectories

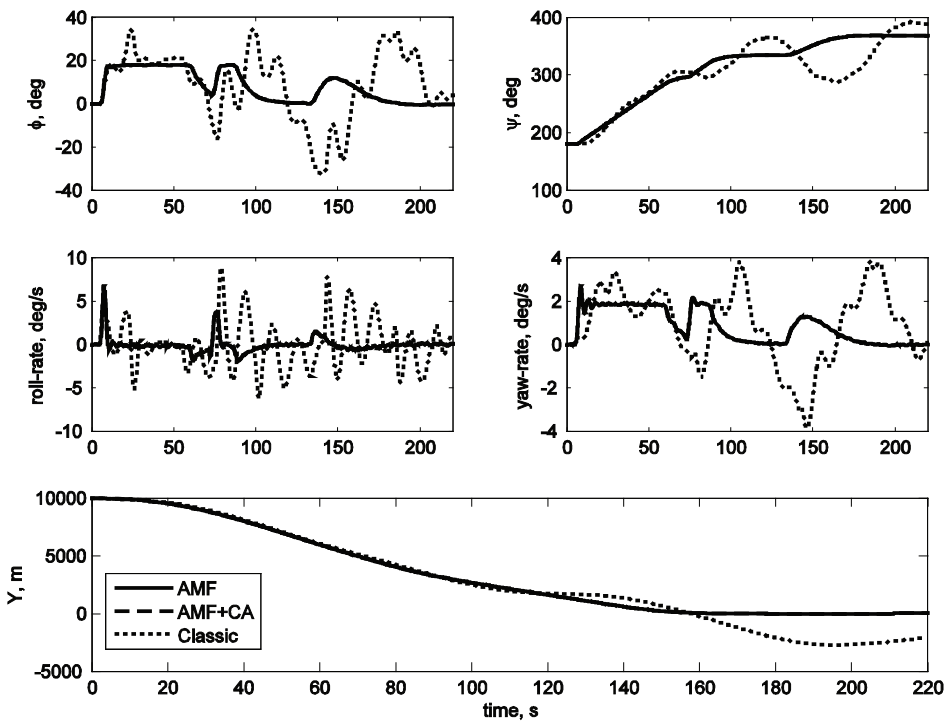

(b) Time plots

Fig. 5. Loss of vertical tail failure scenario, while performing a right turn & localizer intercept runway with classic technique (dotted line), DAMF (solid line) and DAMF+CA (dashed line)

controller. The ability of the DAMF to on-line re-compute the control gains guarantees both robustness and performance, as shown in the proposed test cases. However, the contemporary usage of a control allocation scheme allowed improving significantly the fault-tolerance capabilities, at the only expense of requiring some limited information about the vehicle actuators' health. Therefore the proposed fault-tolerant scheme appears to be very promising to deal with drastic off-nominal conditions as the ones induced by severe actuators failure and damages thus improving the overall adaptive capabilities of a reconfigurable flight control system.

7. References

- Bodson, M. & Groszkiewicz, J. E. (1997). Multivariable Adaptive Algorithms for Reconfigurable Flight Control, *IEEE Transaction on Control Systems Technology*, Vol. 5, No. 2, pp. 217-229.
- Boskovic, J. D. & Mehra, R. K. (2002), Multiple-Model Adaptive Flight Control Scheme for Accommodation of Actuator Failures, *Journal of Guidance, Control, and Dynamics*, Vol. 25, No. 4, pp. 712-724.
- Buffington, J. & Chandler, P. (1998), Integration of on-line system identification and optimization-based control allocation, *Proceedings of AIAA Guidance, Navigation, and Control Conference and Exhibit*, Boston, MA.
- Burken, J. J., Lu, P., Wu, Z. & Bahm, C. (2001), Two Reconfigurable Flight-Control Design Methods: Robust Servomechanism and Control Allocation, *Journal of Guidance, Control, and Dynamics*, Vol. 24, No. 3, pp. 482-493.
- Calise, A. J., Hovakimyan, N. & Idan, M. (2001). Adaptive output feedback control of nonlinear systems using neural networks, *Automatica*, Vol. 37, No. 8, pp. 1201-1211.
- Durham, W. C. & Bordignon, K. A. (1995), Closed-Form Solutions to Constrained Control Allocation Problem, *Journal of Guidance, Control and Dynamics*, Vol. 18, No. 5, pp. 1000-1007.
- Enns, D. (1998), Control Allocation Approaches, *Proceedings of the AIAA Guidance, Navigation and Control Conference*, Boston, MA.
- Harkegard, O. (2002), Efficient Active Set Algorithms for Solving Constrained Least squares Problems in Aircraft Control Allocation, *Proceedings. of the 41st IEEE Conference on Decision and Control*, Vol. 2, pp. 1295-1300.
- Kim, K. S., Lee, K. J. & Kim, Y. (2003), Reconfigurable Flight Control System Design Using Direct Adaptive Method, *Journal of Guidance, Control, and Dynamics*, Vol. 26, No. 4, pp. 543-550.
- Luenberger, D. G. (1989), *Linear and Nonlinear Programming*, 2nd ed., Addison-Welsey, 1989, Chapter 11.
- Patton, R. J. (1997). Fault-Tolerant Control Systems: The 1997 Situation, *Proceedings of the IFAC Symposium on Fault Detection, Supervision and Safety for Technical Processes*, Vol. 2, pp. 1033-1055.
- Smaili, M. H., Breeman, J., Lombaerts, T. J. & Joosten, D. A. (2006), A Simulation Benchmark for Integrated Fault Tolerant Flight Control Evaluation, *Proceedings of AIAA Modeling and Simulation Technologies Conference and Exhibit*, Keystone, CO.
- Tandale, M. & Valasek, J. (2003), Structured Adaptive Model Inversion Control to Simultaneously Handle Actuator failure and Actuator Saturation, *Proceedings. of the AIAA Guidance, Navigation and Control Conference*, Austin, TX.
- Virnig, J. & Bodden, D. (2000), Multivariable Control Allocation and Control Law Conditioning when Control Effector Limit, *Proceedings of the AIAA Guidance, Navigation and Control Conference*, Denver, CO.



Advances in Flight Control Systems

Edited by Dr. Agneta Balint

ISBN 978-953-307-218-0

Hard cover, 296 pages

Publisher InTech

Published online 11, April, 2011

Published in print edition April, 2011

Nonlinear problems in flight control have stimulated cooperation among engineers and scientists from a range of disciplines. Developments in computer technology allowed for numerical solutions of nonlinear control problems, while industrial recognition and applications of nonlinear mathematical models in solving technological problems is increasing. The aim of the book *Advances in Flight Control Systems* is to bring together reputable researchers from different countries in order to provide a comprehensive coverage of advanced and modern topics in flight control not yet reflected by other books. This product comprises 14 contributions submitted by 38 authors from 11 different countries and areas. It covers most of the current main streams of flight control researches, ranging from adaptive flight control mechanism, fault tolerant flight control, acceleration based flight control, helicopter flight control, comparison of flight control systems and fundamentals. According to these themes the contributions are grouped in six categories, corresponding to six parts of the book.

How to reference

In order to correctly reference this scholarly work, feel free to copy and paste the following:

Federico Corraro, Gianfranco Morani and Adolfo Sollazzo (2011). Fault-Tolerance of a Transport Aircraft with Adaptive Control and Optimal Command Allocation, *Advances in Flight Control Systems*, Dr. Agneta Balint (Ed.), ISBN: 978-953-307-218-0, InTech, Available from: <http://www.intechopen.com/books/advances-in-flight-control-systems/fault-tolerance-of-a-transport-aircraft-with-adaptive-control-and-optimal-command-allocation>

INTECH

open science | open minds

InTech Europe

University Campus STeP Ri
Slavka Krautzeka 83/A
51000 Rijeka, Croatia
Phone: +385 (51) 770 447
Fax: +385 (51) 686 166
www.intechopen.com

InTech China

Unit 405, Office Block, Hotel Equatorial Shanghai
No.65, Yan An Road (West), Shanghai, 200040, China
中国上海市延安西路65号上海国际贵都大饭店办公楼405单元
Phone: +86-21-62489820
Fax: +86-21-62489821

© 2011 The Author(s). Licensee IntechOpen. This chapter is distributed under the terms of the [Creative Commons Attribution-NonCommercial-ShareAlike-3.0 License](#), which permits use, distribution and reproduction for non-commercial purposes, provided the original is properly cited and derivative works building on this content are distributed under the same license.