

Iterative Optimization Algorithms to Determine Transmit and Receive Weights for MIMO Systems

Osamu Muta, Takayuki Tominaga, Daiki Fujii, and Yoshihiko Akaiwa
Kyushu University
Japan

1. Introduction

As a technology to realize high data rates and high capacity in wireless communication systems, Multiple-Input Multiple-Output (MIMO) system has received increasing attention. In MIMO systems, high spectral efficiency is achieved by spatially multiplexing multiple data streams at the same time and frequency [1].

The MIMO system with space division multiplexing (SDM) technique is categorized into two cases, i.e., no channel state information (CSI) is needed at the transmitter or CSI is exploited in both transmitter and receiver. As a method used in the former systems, spatial filtering and maximum likelihood detection (MLD) are known [1], where the received SDM signal is de-multiplexed with signal processing at the receiver. One of the latter MIMO systems is called the Eigenbeam SDM (E-SDM) [1][2], where data streams are transmitted through multiple orthogonal eigenpath channels between the transmitter and the receiver. Thus, the E-SDM system with power control based on the water-filling theorem [3] improves the MIMO channel capacity, provided that accurate CSI is known to the transmitter and the receiver. Therefore, it is expected that the E-SDM system achieves significant increase of spectral efficiency. In the E-SDM system, it is important to find optimum transmit and receive weights for maximizing its capacity. Such the optimum weights are determined based on eigenvector of $\mathbf{H}^H\mathbf{H}$, where \mathbf{H} denotes channel matrix and suffix H denotes complex conjugate transpose. As a method to find these eigenvectors, eigenvalue decomposition (EVD) of $\mathbf{H}^H\mathbf{H}$ or singular value decomposition (SVD) of \mathbf{H} is well-known. Generally, SVD or EVD requires matrix decomposition operation based on QR decomposition.

MIMO techniques can be used for multiple access systems where multiple signals are sent from multiple terminals at the same time and same frequency, i.e., Space Division Multiple Access (SDMA) or multi-user MIMO (MU-MIMO) [6]-[9]. When such a multi-antenna system is used at a transmitter, the transmit weights are optimized under the constraint of total transmit power [5]-[9]. However, the maximum transmit power for each antenna element in SDMA systems is not restricted in general assumptions. Therefore, in the worst case, an amplifier whose maximum output power is the same as total transmit power is needed for each antenna element; these amplifiers cause an increase in cost. From this point of view, it is desirable to use a reasonable (i.e., low cost) power amplifier for each antenna element, where per-antenna transmit power is limited within a permissible output power.

To meet this requirement, it is necessary to determine weight coefficients so that the transmit power for each antenna is limited below a given threshold.

In Ref.[10], a method to maximize transmission rate in eigenbeam MIMO-OFDM system under constraint of the maximum transmit power for an antenna has been reported, where the weights are determined by considering only the suppression of inter-stream interference (i.e., the optimum weights are first determined without considering the constraint of per-antenna power, and then the total transmit power is normalized to meet the power constraint). However, this method does not optimize weight coefficients in presence of noise and interference. To find the optimum weights under per-antenna power constraint, these two factors (inter-stream interference and signal-to-noise power ratio) have to be taken into consideration simultaneously.

In this paper, first we propose an iterative optimization algorithm to find optimum transmit and receive weights in an E-SDM system, where the transmitter is equipped with a virtual MIMO channel and virtual receiver to obtain the optimum transmitter weight. The transmitter estimates the optimum transmitter weights by minimizing the error signal at the virtual receiver. Second, we propose an optimization method of transmit and receive weights under constraints of both total transmit power and the maximum transmit power for an antenna element in MU-MIMO systems, where the transmit weights are optimized by minimizing the mean square error of the received signal to obtain the minimum bit error rate (BER) under the per-antenna power constraint, provided that the knowledge of channel state information (CSI) and the receive signal to noise power ratio (SNR) is given. In our study, we solve this optimization problem by transforming the above constrained minimization problem to non-constrained one by using the *Extended Interior Penalty Function (EIPF) Method* [11]. After descriptions of the weight optimization methods, BER and signal-to-noise and interference power ratio (SINR) performance of MIMO systems are evaluated by computer simulation.

2. A least mean square based algorithm to determine the transmit and receive weights in Eigen-beam SDM

2.1 Eigen-beam SDM in MIMO systems

Figure 1 shows a MIMO system model considered in this paper, where N_t and N_r stand for the number of transmit and receive antenna elements, respectively. \mathbf{W}_t denotes $N_t \times N_s$ transmitter weight matrix whose row vectors are given as eigenvector of channel autocorrelation matrix $\mathbf{H}^H \mathbf{H}$, where N_s is the number of data streams. \mathbf{W}_r denotes $N_s \times N_r$ receiver weight matrix. \mathbf{H} is $N_r \times N_t$ channel matrix. To achieve the maximum capacity, the receive weight matrix \mathbf{W}_r is determined as

$$\mathbf{W}_r = \mathbf{W}_t^H \mathbf{H}^H \quad (1)$$

When the transmit and receive data stream vectors are defined as $\mathbf{s} = (s_1, s_2, \dots, s_{N_s})^T$ and $\mathbf{s}_0 = (s_{01}, s_{02}, \dots, s_{0N_s})^T$, respectively, the received data stream in E-SDM system is given as

$$\mathbf{s}_0 = \mathbf{W}_r \mathbf{H} \mathbf{W}_t \mathbf{s} + \mathbf{W}_r \mathbf{n} = \mathbf{W}_t^H \mathbf{H}^H \mathbf{H} \mathbf{W}_t \mathbf{s} + \mathbf{W}_t^H \mathbf{H}^H \mathbf{n} \quad (2)$$

where $\mathbf{n} = (n_1, n_2, \dots, n_{N_r})^T$ is noise signal vector.

2.2 Iterative optimization of transmit- and receive-weights in E-SDM

a. System Description

Figure 2 shows a block diagram of an E-SDM system using the proposed LMS based algorithm, where it is assumed that the transmitter is equipped with a virtual MIMO channel and virtual receiver. Figure 3 shows transmission frame structure assumed in this paper, where transmission frame is composed of pilot and data symbols. Pilot symbols are used for weight determination at the receiver. In this paper, for simplicity, we assume that channel state information is perfectly estimated at the receiver and correctly informed to the transmitter by a feedback channel.

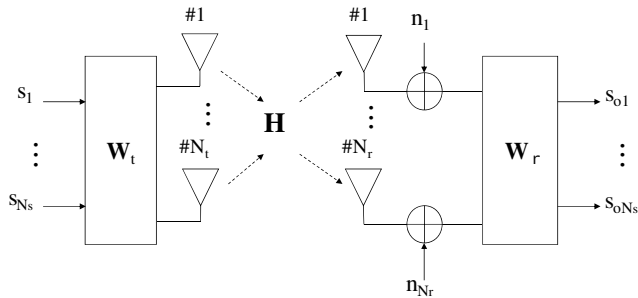

Fig. 1. MIMO System Model

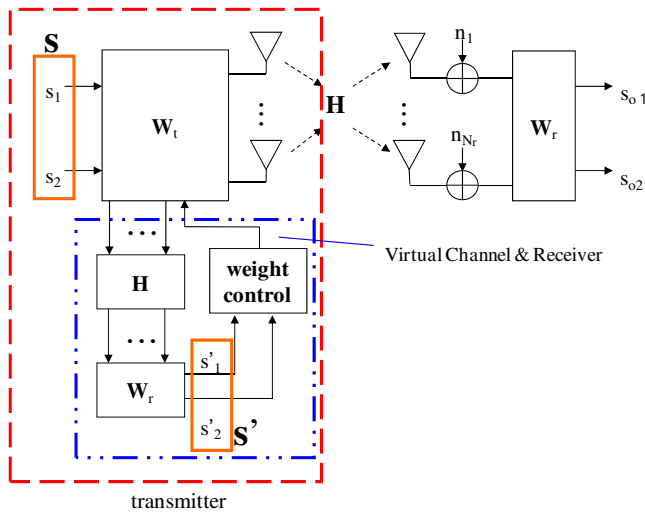

Fig. 2. E-SDM system with iterative weight optimization

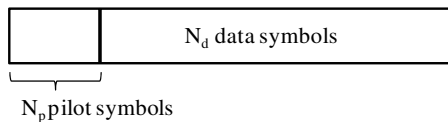

Fig. 3. Frame format

The optimum weight matrices are obtained by minimizing the error signal attributable to inter-stream interference and noise at the receiver side, i.e., the error signal is defined as the difference between transmit and receive signal vectors. This means that, in E-SDM system using the proposed algorithm, weight optimization cannot be performed at the transmitter. To solve this problem, we employ a virtual MIMO channel and virtual receiver on the transmitter side as shown in Fig.2. The received signal at the virtual receiver is expressed as

$$\mathbf{s}'_o = \mathbf{W}_r \mathbf{H} \mathbf{W}_t \mathbf{s} = \mathbf{W}_t^H \mathbf{H}^H \mathbf{H} \mathbf{W}_t \mathbf{s} \tag{3}$$

where $\mathbf{s}'_o = (s'_{o1}, s'_{o2}, \dots, s'_{oNs})$ and s'_{oi} is i -th receive stream at the virtual receiver. After determining optimum transmitter weight matrix, the weighted data stream is transmitted to MIMO channel. At the receiver, optimum receiver weight matrix is calculated by observing the pilot symbols. It is noteworthy that the receiver can find optimum receive weight by minimizing the error signal at the receiver, if the optimum transmit weight is multiplied at the transmitter.

b. Iterative Algorithm to Determine the Transmit and Receive Weights

The detailed algorithm to determine optimum weights in the proposed method is explained as follows. For simplicity of discussion, it is assumed that channel matrix \mathbf{H} is known to the transmitter. From the relation of Eq.(1), it can be seen that the maximum capacity in E-SDM system is achieved by constructing the matrix \mathbf{W}_t whose row vectors are given as eigenvectors of $\mathbf{H}^H \mathbf{H}$. Therefore, in the proposed method, eigenvector of channel matrix is sequentially obtained by using a recursive calculation such as *least mean square* (LMS) algorithm. In the following discussion, we consider 2x2 MIMO system for simplicity, i.e., two eigenpaths exist. The detailed expression of the received signal in 2x2 MIMO system can be given as

$$\begin{bmatrix} s_{o1} \\ s_{o2} \end{bmatrix} = \begin{bmatrix} w_{t11}^* & w_{t21}^* \\ w_{t12}^* & w_{t22}^* \end{bmatrix} \mathbf{H}^H \mathbf{H} \begin{bmatrix} w_{t11} & w_{t12} \\ w_{t21} & w_{t22} \end{bmatrix} \begin{bmatrix} s_1 \\ s_2 \end{bmatrix} = \begin{bmatrix} \mathbf{w}_{t1}^H \\ \mathbf{w}_{t2}^H \end{bmatrix} \mathbf{H}^H \mathbf{H} \begin{bmatrix} \mathbf{w}_{t1} & \mathbf{w}_{t2} \end{bmatrix} \begin{bmatrix} s_1 \\ s_2 \end{bmatrix} \tag{4}$$

where $\mathbf{w}_{t1} = (w_{t11}, w_{t21})^T$ and $\mathbf{w}_{t2} = (w_{t12}, w_{t22})^T$ denote column vectors of weight matrix, i.e., the transmit weight vectors for data streams of s_1 and s_2 . It is noteworthy that the discussion for 2x2 MIMO system can be easily extended to the case of arbitrary number of transmit and receive antennas as explained later.

First, we consider the optimization of the first weight vector \mathbf{w}_{t1} corresponding to data stream s_1 . The first received data stream in E-SDM system is given as

$$s_{o1} = \mathbf{w}_{t1}^H \mathbf{H}^H \mathbf{H} \mathbf{w}_{t1} s_1 \tag{5}$$

where the effect of noise is neglected here. The above equation suggests that the condition for orthogonal multiplexing of data streams in E-SDM system is given as $\mathbf{w}_{t1}^H \mathbf{H}^H \mathbf{H} \mathbf{w}_{t1} = 1$, i.e., when this condition is satisfied, \mathbf{w}_{t1} becomes one of eigenvectors of $\mathbf{H}^H \mathbf{H}$. Thus, the error signal e_1 corresponding to the first data stream is defined as

$$e_1 = s_1 - s_{o1} \tag{6}$$

In this case, the error signal defined in Eq.(6) cannot be obtained at the transmitter. Therefore, by substituting s_{o1} for the first virtual received stream s'_{o1} in Fig.2, the error signal is modified to

$$e_1 = s_1 - s'_{o1} = s_1 - \mathbf{w}_{t1}^H \mathbf{H}^H \mathbf{H} \mathbf{w}_{t1} s_1 \tag{7}$$

Thus, the mean square error is obtained as

$$E[|e_1|^2] = E[|s_1|^2] - 2\mathbf{w}_{t1}^H E[\mathbf{H}^H \mathbf{H}] \mathbf{w}_{t1} E[|s_1|^2] + (\mathbf{w}_{t1}^H E[\mathbf{H}^H \mathbf{H}] \mathbf{w}_{t1})^2 E[|s_1|^2] \tag{8}$$

In Eq.(8), we can see that local minimum value does not exist and therefore optimum solution is obtained with a simple iterative algorithm such as LMS method, since Eq.(8) is the fourth order equation with respect to the weight vector \mathbf{w}_{t1} and the first, second and third terms of right side in Eq.(8) are the zero-th, second and fourth order expressions with respect to \mathbf{w}_{t1} , respectively.

By differentiating Eq. (8) with respect to \mathbf{w}_{t1} , we can obtain

$$\nabla \mathbf{w}_{t1} E[|e_1|^2] = -4E[\mathbf{H}^H \mathbf{H}] \mathbf{w}_{t1} E[|s_1|^2] + 4E[\mathbf{H}^H \mathbf{H}] \mathbf{w}_{t1} \mathbf{w}_{t1}^H E[\mathbf{H}^H \mathbf{H}] \mathbf{w}_{t1} \tag{9}$$

where $\nabla \mathbf{w} = \frac{\partial}{\partial \mathbf{w}_x} - j \frac{\partial}{\partial \mathbf{w}_y}$ ($\mathbf{w} = \mathbf{w}_x + j\mathbf{w}_y$). Thus, the recursive equation to obtain the first weight vector is given as

$$\mathbf{w}_{t1}(m+1) = \mathbf{w}_{t1}(m) - \frac{\mu}{4} \nabla \mathbf{w}_{t1} E[|e_1|^2] \tag{10}$$

In this paper, to achieve fast convergence time, we employ the normalized LMS algorithm[4]. Hence, after substituting Eq.(9) for the above equation and expectation operation is removed, Eq.(10) is reduced to

$$\mathbf{w}_{t1}(m+1) = \mathbf{w}_{t1}(m) + \frac{\mu}{|\mathbf{r}_1(m)|^2} \mathbf{H}^H \mathbf{r}_1(m) e_1^*(m) \tag{11}$$

where m is an integer number corresponding to the number of iterations in the LMS algorithm and μ denotes step size. \mathbf{r}_1 is the received signal given by $\mathbf{r}_1(m) = \mathbf{H} \mathbf{w}_{t1}(m) s_1$. After the first weight vector is determined, we consider optimization of the second weight vector \mathbf{w}_{t2} corresponding to data stream s_2 . Similarly in the first case, the error signal for the second data stream is defined as

$$e_2 = s_2 - \mathbf{w}_{t2}^H \mathbf{H}^H \mathbf{H} \mathbf{w}_{t2} s_2 - \mathbf{w}_{t2}^H \mathbf{H}^H \mathbf{H} \mathbf{w}_{t1} s_1 \tag{12}$$

where \mathbf{w}_{t1} is set to the optimum value obtained in the first case in Eq. (11). In Eq.(12), the second and third terms in right hand side of this equation mean that "condition where the second eigenvector exists" and the third term means "condition where a target vector \mathbf{w}_{t2} is orthogonal to the first eigenvector \mathbf{w}_{t1} ". Hence, if $e_2=0$, we can obtain the second eigenvector \mathbf{w}_{t2} . Thus, mean square error of the error signal e_2 is given as

$$E[|e_2|^2] = E[|s_2|^2] - 2\mathbf{w}_{t2}^H E[\mathbf{H}^H \mathbf{H}] \mathbf{w}_{t2} E[|s_2|^2] + (\mathbf{w}_{t2}^H E[\mathbf{H}^H \mathbf{H}] \mathbf{w}_{t2})^2 E[|s_2|^2] + \mathbf{w}_{t2}^H E[\mathbf{H}^H \mathbf{H}] \mathbf{w}_{t1} \mathbf{w}_{t1}^H E[\mathbf{H}^H \mathbf{H}] \mathbf{w}_{t2} E[|s_1|^2] \tag{13}$$

The above equation implies that local minimum solution does not exist and the optimum solution with minimum square error is definitely determined as well as in Eq. (8). Thus, by differentiating this equation respect to \mathbf{w}_{t2} , we can obtain

$$\begin{aligned} \nabla_{\mathbf{w}_{t2}} E\left[|e_2|^2\right] &= -4E\left[\mathbf{H}^H \mathbf{H}\right] \mathbf{w}_{t2} E\left[|s_2|^2\right] + 4E\left[\mathbf{H}^H \mathbf{H}\right] \mathbf{w}_{t2} \mathbf{w}_{t2}^H E\left[\mathbf{H}^H \mathbf{H}\right] \mathbf{w}_{t2} \\ &+ 2E\left[\mathbf{H}^H \mathbf{H}\right] \mathbf{w}_{t1} \mathbf{w}_{t1}^H E\left[\mathbf{H}^H \mathbf{H}\right] \mathbf{w}_{t2} E\left[|s_1|^2\right] \end{aligned} \tag{14}$$

After substituting this equation for Eq.(10) and removing the expectation operation, Eq.(10) is reduced to

$$\mathbf{w}_{t2}(m+1) = \mathbf{w}_{t2}(m) + \frac{\mu}{|\mathbf{r}_2(m)|^2} \left(\mathbf{H}^H \mathbf{r}_2(m) e_2^*(m) - \frac{1}{2} \mathbf{H}^H \mathbf{w}_{t1} \mathbf{w}_{t1}^H \mathbf{H} \mathbf{w}_{t2}(m) |s_1|^2 \right) \tag{15}$$

where $\mathbf{r}_2(m) = \mathbf{H}(\mathbf{w}_{t1}(m)s_1 + \mathbf{w}_{t2}(m)s_2)$. The optimum weight matrix \mathbf{W}_i is obtained by updating weight vectors of these two recursive equations, i.e., Eqs. (11) and (15).

The above discussion on 2x2 MIMO system is easily extended to $N_t \times 2$ or $2 \times N_r$ MIMO system, i.e., for $N_t \times 2$ MIMO system, the received signal at the virtual receiver can be given as

$$\begin{bmatrix} s'_{o1} \\ s'_{o2} \end{bmatrix} = \begin{bmatrix} w_{t11}^* & \cdots & w_{tN_t1}^* \\ w_{t12}^* & \cdots & w_{tN_t2}^* \end{bmatrix} \mathbf{H}^H \mathbf{H} \begin{bmatrix} w_{t11} & w_{t12} \\ \vdots & \vdots \\ w_{tN_t1} & w_{tN_t2} \end{bmatrix} \begin{bmatrix} s_1 \\ s_2 \end{bmatrix} = \begin{bmatrix} \mathbf{w}_{t1}^H \\ \mathbf{w}_{t2}^H \end{bmatrix} \mathbf{H}^H \mathbf{H} \begin{bmatrix} \mathbf{w}_{t1} & \mathbf{w}_{t2} \end{bmatrix} \begin{bmatrix} s_1 \\ s_2 \end{bmatrix} \tag{16}$$

where $\mathbf{w}_{t1} = (w_{t11}, \dots, w_{tN_t1})^T$ and $\mathbf{w}_{t2} = (w_{t12}, \dots, w_{tN_t2})^T$. From this equation, it is clear that optimum weight matrixes for $N_t \times 2$ MIMO system are obtained by the same way as 2x2 MIMO case, since channel autocorrelation matrix $\mathbf{H}^H \mathbf{H}$ is given as $N_t \times N_t$ matrix. For case of $2 \times N_r$ MIMO system, since the autocorrelation matrix $\mathbf{H}^H \mathbf{H}$ is given as 2x2 matrix, the same discussion as 2x2 MIMO case can be applied.

In addition, the proposed method can be applied to case where the rank of channel matrix is more than two, e.g., when the rank of channel matrix is 3, optimum weight matrix is obtained by minimizing the error function defined so that the third weight vector \mathbf{w}_{t3} is orthogonal to both the first and second weight vectors of \mathbf{w}_{t1} and \mathbf{w}_{t2} , where the weight vectors obtained in the previous calculation, i.e., \mathbf{w}_{t1} and \mathbf{w}_{t2} , are used as the fixed vectors in this case. Thus, it is obvious that this discussion can be extended to case of channel matrix with the rank of more than 3.

In the proposed method, the parameter convergence speed depends on initial values of weight coefficients. When continuous data transmission is assumed, the convergence time becomes faster by employing weight vectors in last data frame as initial parameters in current recursive calculation.

2.3 Simulation results

We evaluate the performance of a MIMO system using the proposed algorithm by computer simulation. For comparison purpose, obtained eigenvalues, bit error rate (BER) and capacity performance of the E-SDM systems using the proposed algorithm are compared to cases

with SVD. Simulation parameters are summarized in Table 1. QPSK with coherent detection is employed as modulation/demodulation scheme. Propagation model is flat uncorrelated quasistatic Rayleigh fading, where we assume that there is no correlation between paths. In the iterative calculation, an initial value of weight vector is set to $(1, 0, 0, \dots, 0)^T$ for both \mathbf{w}_{t1} and \mathbf{w}_{t2} . The step size of μ is set to 0.01 for \mathbf{w}_{t1} and 0.0001 for \mathbf{w}_{t2} , respectively. A frame structure consisting of 57 pilot and 182 data symbols in Fig.3 is employed. For simplicity, we assume that channel parameters are perfectly estimated at the receiver and sent back to the transmitter side in this paper.

Number of users	1
Number of data streams	1, 2
(Number of the transmit antennas × Number of the receive antennas)	(2×2), (3×2), (4×2), (2×3), (2×4)
Data modulation / demodulation	QPSK / Coherent detection
Angular spread (Tx & Rx Station)	360°
Propagation model	Flat uncorrelated quasistatic Rayleigh fading

Table 1. Simulation parameters

Figure 4 shows the first and second eigenvalues measured by the proposed method as a function of the frame number in 2×2 MIMO system, where these eigenvalues are obtained by using channel matrix and the transmit and receive weights determined by the proposed algorithm. Figure 4 also shows eigenvalues determined by the SVD method. In Fig. 4, although the first eigenvalue obtained by the proposed method occasionally takes slightly smaller value than that of SVD, the proposed method finds almost the same eigenvectors as the theoretical value obtained by SVD.

Figure 5 shows BER performance of $N_t \times 2$ MIMO diversity system using the maximum ratio combining (MRC) as a function of transmit signal to noise power ratio, where average gain of channel is unity. Figure 6 also shows BER performance of $2 \times N_r$ MIMO MRC diversity system. In Figs. 5 and 6, the data stream is transmitted by the first eigenpath. Therefore, it can be seen that both methods (LMS, SVD) achieve almost the same BER performance. This result suggests that the eigenvector corresponding to the highest eigenvalue is correctly detected as the first weight vector, i.e., the first eigenpath. It can be also qualitatively explained that the highest eigenvalue is first found as the most dominant parameter determining the error signal.

Figures 7 and 8 show BER performance of $N_t \times 2$ and $2 \times N_r$ E-MIMO, respectively. The number of data streams is set to two, since the rank of channel matrix is two. Based on the BER minimization criterion [1], the achievable BER is minimized by multiplying the transmit signal by the inverse of the corresponding eigenvalue at the transmitter. In Figs. 7 and 8, we can see that both methods (LMS and SVD) achieve almost the same BER performance.

Figures 9 and 10 show the MIMO channel capacity in case of two data streams. In this paper, for simplicity, MIMO channel capacity is defined as the sum of each eigenpath channel capacity which is calculated based on Shannon channel capacity in AWGN channel [3];

$$C = \log_2 (1 + \text{SNR}) \quad [\text{bit/s/Hz}] \tag{17}$$

The transmit power allocation for each eigenpath is determined based on the water-filling theorem [3]. In Figs.9 and 10, it can be seen that the E-SDM system with the proposed method achieves the same channel capacity as that of the ideal one (SVD).

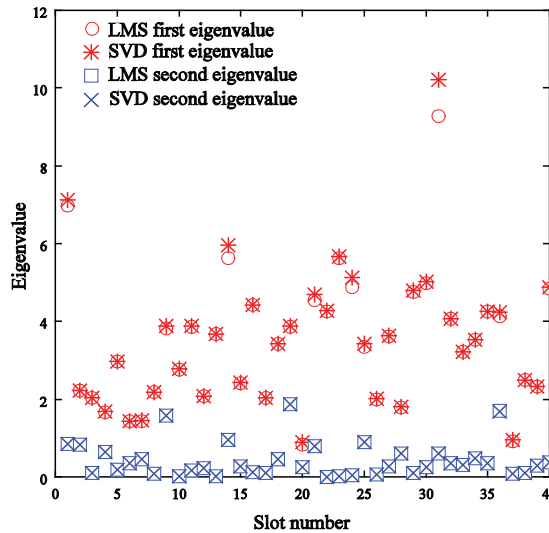

Fig. 4. Measured eigenvalues

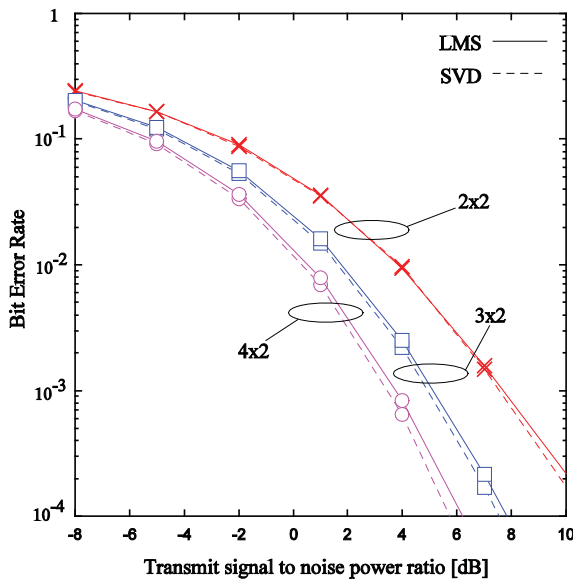

Fig. 5. Bit error rate performance (1 data stream, $N_t \times 2$)

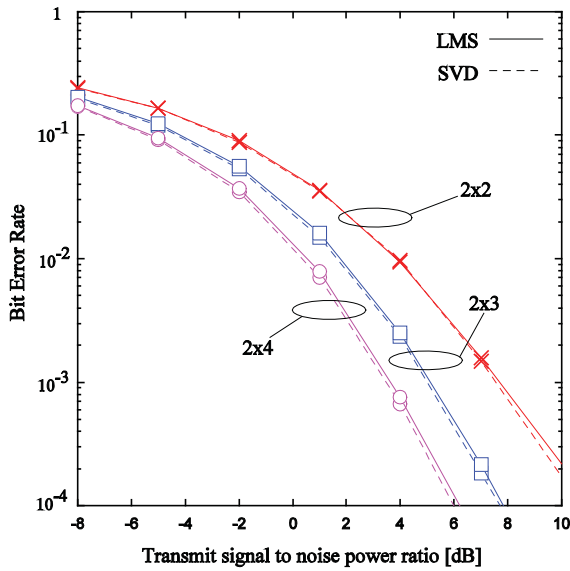

Fig. 6. Bit error rate performance (1 data stream, $2 \times N_r$)

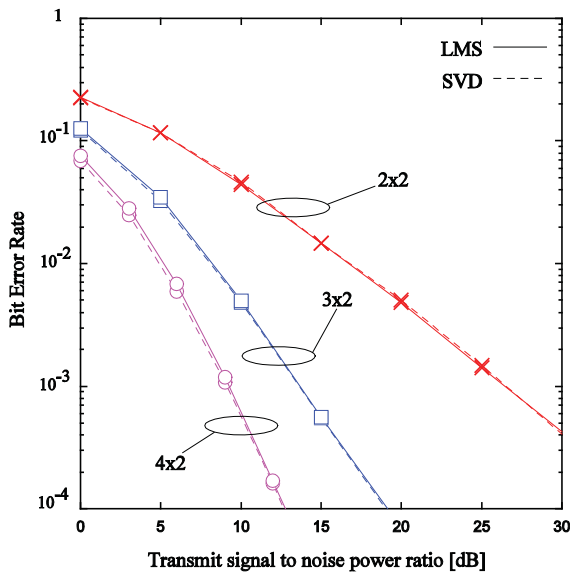

Fig. 7. Bit error rate performance (2 data stream, $N_t \times 2$)

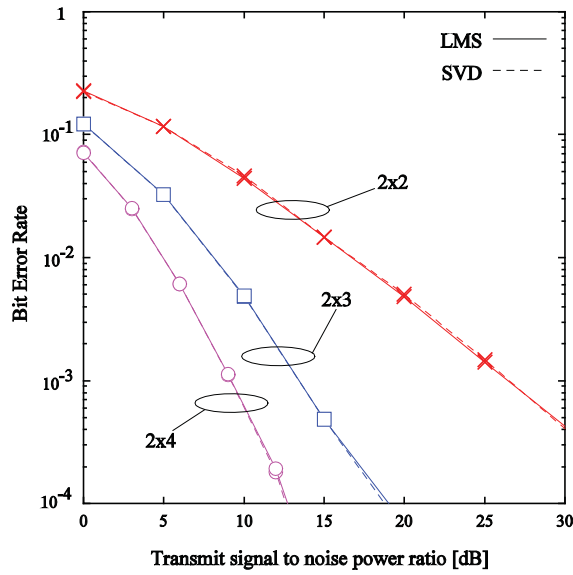

Fig. 8. Bit error rate performance (2 data stream, $2 \times N_r$)

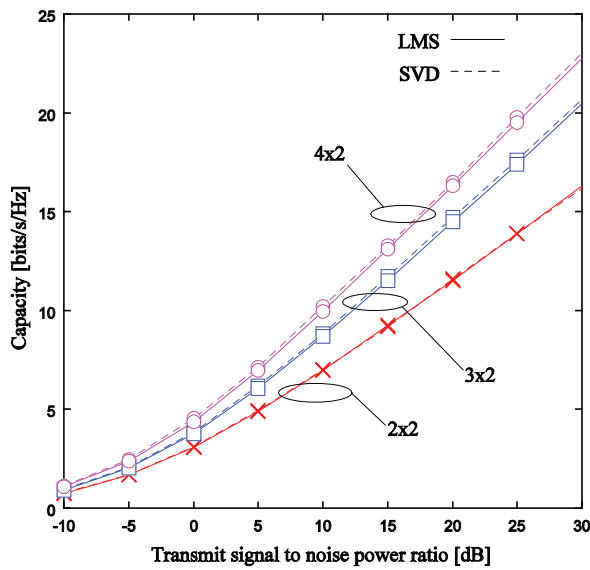

Fig. 9. Channel capacity performance ($N_t \times 2$)

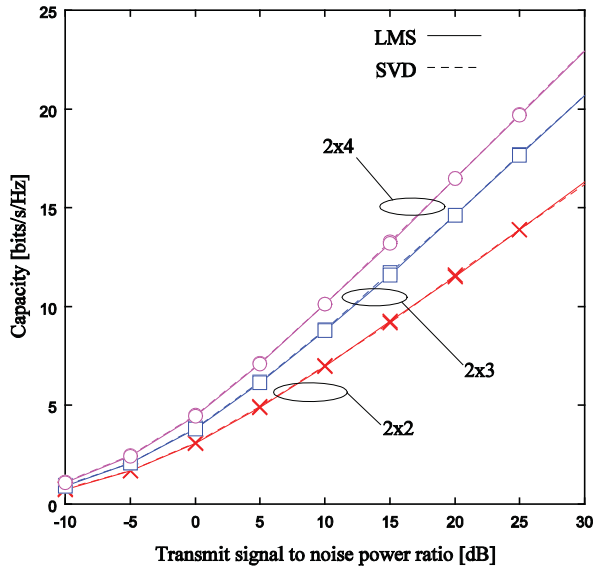

Fig. 10. Channel capacity performance (2xN_r)

3. Iterative optimization of the transmitter weights under constraint of the maximum transmit power for an antenna element in MIMO systems

3.1 System model

Figure 11 shows MU-MIMO system considered in this paper, where K antenna elements and single antenna element are equipped at the Base Station (BS) and Mobile Station (MS), respectively. Single antenna is assumed for each Mobile Station (MS). The number of users in SDMA is N. The receive signal at receive antenna $\mathbf{Y}=[y_1, \dots, y_N]^T$ is expressed as

$$\mathbf{Y} = \mathbf{W}_r^H \mathbf{H} \mathbf{W}_t^H \mathbf{X} + \mathbf{W}_r^H \mathbf{n} \tag{18}$$

where superscript T and superscript H denote transpose and Hermitian transpose, respectively. \mathbf{H} is $N \times K$ complex channel metrics, \mathbf{W}_t is $N \times K$ complex transmit weight matrices, $\mathbf{W}_r = \text{diag}(w_1, \dots, w_N)$ is receive weight metrics, $\mathbf{X}=[x_1, \dots, x_N]^T$ is transmit signal, and $\mathbf{n}=[n_1, \dots, n_N]^T$ is noise signal. The average power of transmit signal is unity (i.e., $E[x_i^2] = 1$), where $E[\]$ denotes ensemble average operation) and there is no correlation between each user signal (i.e., $E[x_{i1} x_{i2}] = 0$), the condition to keep the total average transmit power to be less than or equal to P_{th} is given as

$$\sum_{i=1}^N \sum_{j=1}^K |w_{ij}|^2 \leq P_{th} \tag{19}$$

where w_{ij} denotes the transmit weight of antenna #j for user #i. Then, the condition to constrain the average transmit power per each antenna to be less than or equal to p_{th} is given as

$$\sum_{i=1}^N |w_{ij}|^2 \leq p_{th} \quad \forall j \quad (1 \leq j \leq K) \tag{20}$$

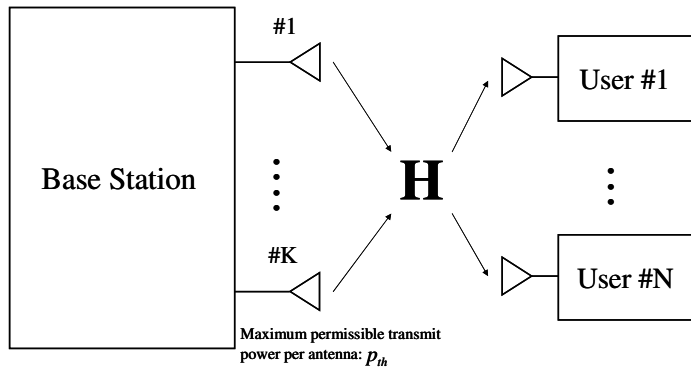

Fig. 11. MU-MIMO Systems

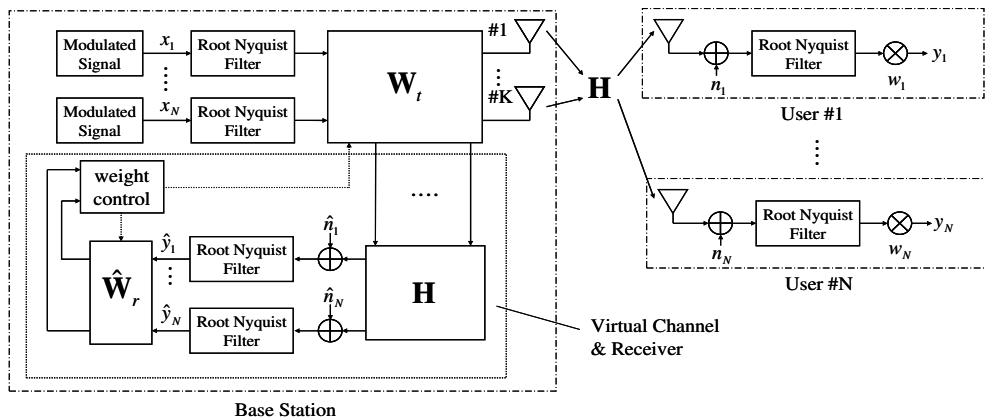

Fig. 12. System configurations

Pilot N_p symbols	Data N_d symbols
------------------------	-----------------------

Fig. 13. Frame format

3.2 Transmitter and receiver model

Figure 12 shows the system configuration of the transmitter and receiver in MU-MIMO system considered in this paper, where the number of transmit antennas and the number of receive antennas are K and 1 , respectively. A virtual channel and virtual receiver are equipped with the transmitter to estimate mean square error at the receiver side, where

$\hat{\mathbf{W}}_r = \text{diag}(\hat{w}_1, \dots, \hat{w}_N)$ and $\hat{\mathbf{n}} = [\hat{n}_1, \dots, \hat{n}_N]^T$ denote the virtual receive weight and the virtual noise, respectively. We assume that the average power of additive white Gaussian noise (AWGN) is known to the transmitter, i.e., we assume $E[\hat{n}_i^2] = E[n_i^2]$. Then, the receive signal at the virtual receiver $\hat{\mathbf{Y}}$ is given as

$$\hat{\mathbf{Y}} = \hat{\mathbf{W}}_r^H \mathbf{H} \mathbf{W}_t^H \mathbf{X} + \hat{\mathbf{W}}_r^H \hat{\mathbf{n}} \tag{21}$$

The transmit weights are optimized by minimizing the error signal between transmit and receive signals at the virtual receiver under constraints given as Eqs.(19) and (20). Figure 13 shows a frame format assumed in this paper, where each frame consists of N_p pilot symbols and N_d data symbols. Pilot symbols are known and used for optimizing the receive weights on the receiver side.

3.3 Weight optimization

a. Problem Formulation

The transmit weights are optimized by minimizing the mean square error between transmit and receive signals at the virtual receiver under constraint given as Eqs. (19) and (20). From Eq.(21), the error signal between transmit signal \mathbf{X} and receive signal at the virtual receiver $\hat{\mathbf{Y}}$ is given as

$$\mathbf{e} = \mathbf{X} - \hat{\mathbf{Y}} = \mathbf{X} - \hat{\mathbf{W}}_r^H \mathbf{H} \mathbf{W}_t^H \mathbf{X} - \hat{\mathbf{W}}_r^H \hat{\mathbf{n}} \tag{22}$$

where $\mathbf{e} = [e_1, \dots, e_N]$. From Eqs.(19) and (20), the problem to minimize the mean square error under two constraints can be formulated as the following constrained minimizing problem;

$$\begin{aligned} & \text{Minimize } E[\|\mathbf{e}(\mathbf{W})\|^2] \\ & \text{Subject to } g(\mathbf{W}) = \sum_{i=1}^N \sum_{j=1}^K |w_{ij}|^2 - P_{th} \leq 0 \\ & h_j(\mathbf{W}) = \sum_{i=1}^N |w_{ij}|^2 - p_{th} \leq 0 \quad \forall j \end{aligned} \tag{23}$$

where $\|\cdot\|$ denotes vector norm. \mathbf{W} is $N \times (N+K)$ complex matrix defined as $\mathbf{W} = [\mathbf{W}_t, \hat{\mathbf{W}}_r]$.

b. A EIPF based Approach for Weight Optimization

By introducing the extended interior penalty function (EIPF) method into the problem shown in Eq.(23), this problem can be transformed into the following non-constrained minimizing problem [11];

$$\begin{aligned} & \text{Minimize } E[\|\mathbf{e}(\mathbf{W})\|^2] + r\{\Phi(\mathbf{W}) + \Psi(\mathbf{W})\} \\ & \text{Subject to } \Phi(\mathbf{W}) = \begin{cases} -\frac{1}{g(\mathbf{W})} & \text{if } g(\mathbf{W}) \leq \varepsilon \\ -\frac{2\varepsilon - g(\mathbf{W})}{\varepsilon^2} & \text{if } g(\mathbf{W}) > \varepsilon \end{cases} \end{aligned}$$

$$\Psi(\mathbf{W}) = \sum_{j=1}^K \psi_j(\mathbf{W})$$

$$\psi_j(\mathbf{W}) = \begin{cases} -\frac{1}{h_j(\mathbf{W})} & \text{if } h_j(\mathbf{W}) \leq \varepsilon \\ -\frac{2\varepsilon - h_j(\mathbf{W})}{\varepsilon^2} & \text{if } h_j(\mathbf{W}) > \varepsilon \end{cases}$$

Here, $\varepsilon (<0)$ and $r (>0)$ denote the design parameters for non-constrained problem. In Eq.(24), $\Phi(\mathbf{W})$ and $\Psi(\mathbf{W})$ increase rapidly as \mathbf{W} approaches to the boundary. When $g(\mathbf{W}) = \varepsilon$ and $h_j(\mathbf{W}) = \varepsilon$, the continuity of $\Phi(\mathbf{W})$ and $\Psi(\mathbf{W})$ is guaranteed as well as derivatives of these two functions. Thus, Eq. (24) can be minimized by using the Steepest Descent method; \mathbf{W} is updated as

$$\mathbf{W}(m+1) = \mathbf{W}(m) - \mu \nabla_{\mathbf{W}} \left(E \left[\|\mathbf{e}(\mathbf{W})\|^2 \right] + r \{ \Phi(\mathbf{W}) + \Psi(\mathbf{W}) \} \right) \tag{28}$$

where μ is a step size to adjust the updating speed. $\nabla_{\mathbf{W}}$ denotes a gradient with respect to \mathbf{W} , which is defined as

$$\nabla_{\mathbf{W}} = \begin{bmatrix} \frac{\partial}{\partial w_{11}} & \dots & \frac{\partial}{\partial w_{1K}} & \frac{\partial}{\partial \hat{w}_1} & \dots & \mathbf{0} \\ \vdots & \ddots & \vdots & & \ddots & \\ \frac{\partial}{\partial w_{N1}} & \dots & \frac{\partial}{\partial w_{NK}} & \mathbf{0} & & \frac{\partial}{\partial \hat{w}_N} \end{bmatrix} \tag{29}$$

where j denotes an imaginary unit and

$$\frac{\partial}{\partial w_{ij}} = \frac{\partial}{\partial \{ \text{Re}(w_{ij}) \}} + j \frac{\partial}{\partial \{ \text{Im}(w_{ij}) \}}, \tag{30}$$

$$\frac{\partial}{\partial \hat{w}_i} = \frac{\partial}{\partial \{ \text{Re}(\hat{w}_i) \}} + j \frac{\partial}{\partial \{ \text{Im}(\hat{w}_i) \}}, \tag{31}$$

When \mathbf{W} is updated as in Eq. (28) at every symbols, Eq. (28) can be reduced to

$$\mathbf{W}(m+1) = \mathbf{W}(m) - \mu \nabla_{\mathbf{W}} \left[\|\mathbf{e}(\mathbf{W})\|^2 + r \{ \Phi(\mathbf{W}) + \Psi(\mathbf{W}) \} \right]. \tag{32}$$

3.4 Performance evaluation

Performance of MU-MIMO system using the considered algorithm is evaluated by computer simulation. Simulation parameters are shown in Table 2. As a channel model, we consider a set of 8 plane waves transmitted in random direction within the angle range of 12 degrees at the BS. Each of the plane waves has constant amplitude and takes the random phase distributed from 0 to 2π . All users are randomly distributed with a uniform distribution in a range of the coverage area of a BS. Channel states and distribution of users

change independently at every frame. Transmit weights are determined with recursive calculation given in Eq.(32). Receive weights are determined by observing the pilot symbols. The upper limit of the average transmit power for an antenna element normalized by the upper limit of the total transmit power is denoted as

$$\gamma = \frac{P_{th}}{P_{th}} \tag{33}$$

where

$$\frac{1}{K} \leq \gamma \leq 1 \tag{34}$$

In Eq.(34), $\gamma=1$ corresponds to the case without constraint of per-antenna transmit power. The minimum value of γ is $1/K$ which corresponds to, the strictest case where per-antenna transmit power is limited within the minimum value. The maximum permissible power per user (P_{th}/N) to noise power ratio is defined as

$$SNR_{max} = \frac{P_{th} / N}{E[|n_i|^2]} \tag{35}$$

where $E[|n_i|^2]$ denotes the average noise power corresponding to the user #i.

Channel Model	Flat uncorrelated quasistatic Rayleigh fading
Modulation Method	QPSK
Number of Pilot Symbols (N_p)	34 [symbols/frame]
Number of Data Symbols (N_d)	460 [symbols/frame]
Average propagation loss	0 [dB] (Except for Figs.20 and 21)
Antenna element spacing	5.25λ

Table 2. Simulation Parameters

Figures 14(a) and (b) show complementary cumulative distribution function (CCDF) of average transmit power of transmit signal measured at every frames with respect to antenna #1. The number of transmit antennas is set to 4 and 8, respectively. The number of users is 2. The maximum permissible transmit power is set to $P_{th}=1.0$, and average noise power is set to $E[|n_i|^2]=0.1$. From these figures, we can see that transmit power of the signal at antenna #1 can be kept below p_{th} .

Figures 15 and 16 show the received SINR as a function of γ , where SNR_{max} is set to 10 dB. Note that SINR is the same as SNR when the number of users is 1. In these figures, we can see that the degradation in SINR at $\gamma=1/K$ is about 0.5dB and 0.6 ~ 1.0dB for $K=4$ and 8 as compared with the case of $\gamma=1$. It is shown that SINR is slightly degraded when $\gamma \leq 0.4$ and $\gamma \leq 0.3$ for $K=4$ and $K=8$, respectively. This is because the probability that transmit power of the signal at a certain antenna element exceeds γ becomes low as γ increases. The received SINR is degraded as the number of users increases, because the diversity effect is reduced attributable to the decrease of a degree of freedom on the number of antennas.

Figures 17 and 18 show BER performance as a function of SNR_{max} , where the number of users is set to 1~3 for $K=4$ in Fig.17, and set to 3 for $K=8$ in Fig.18. In these figures, we can see that, when the maximum per-antenna transmit power is limited to $1/K$, BER performances is degraded by about 0.7~0.8 dB at $BER=10^{-2}$ as compared with case of $\gamma=1$.

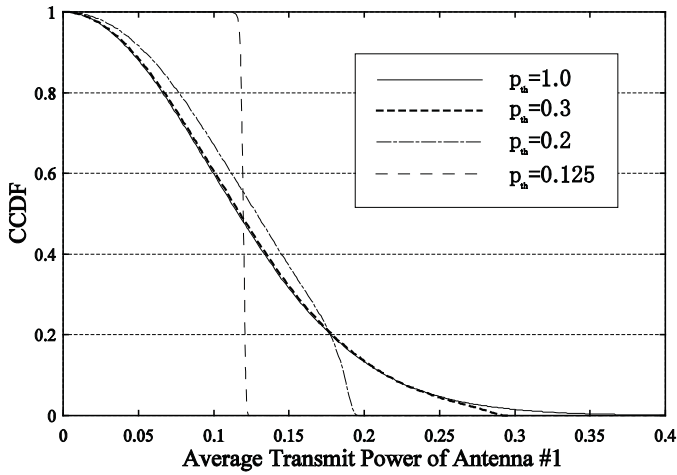

(a) $K=4, N=2$

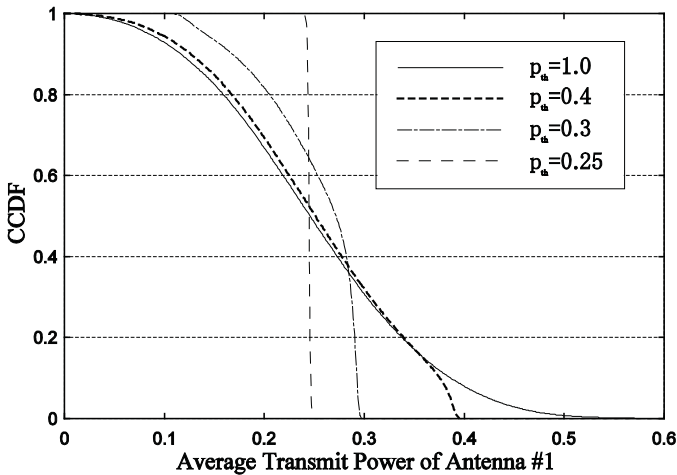

(b) $K=8, N=2$

Fig. 14. CCDF of average transmit power of the signal measured at every frames with respect to antenna #1

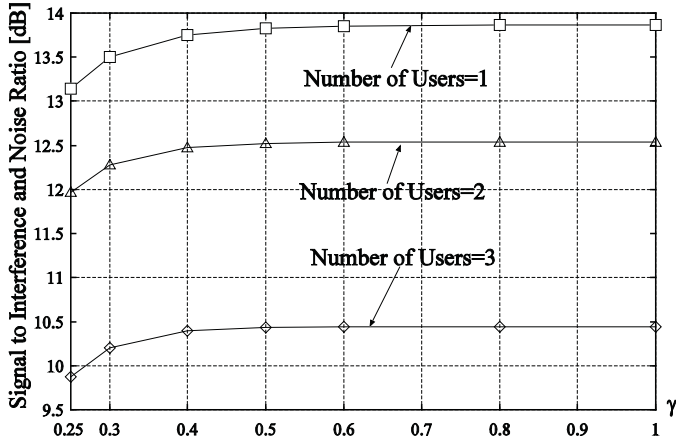

Fig. 15. SINR vs. γ ($K=4$, $SNR_{max}=10\text{dB}$)

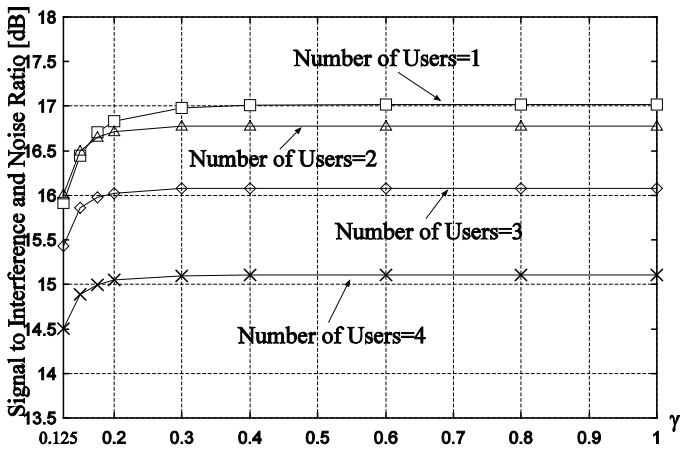

Fig. 16. SINR vs. γ ($K=8$, $SNR_{max}=10\text{dB}$)

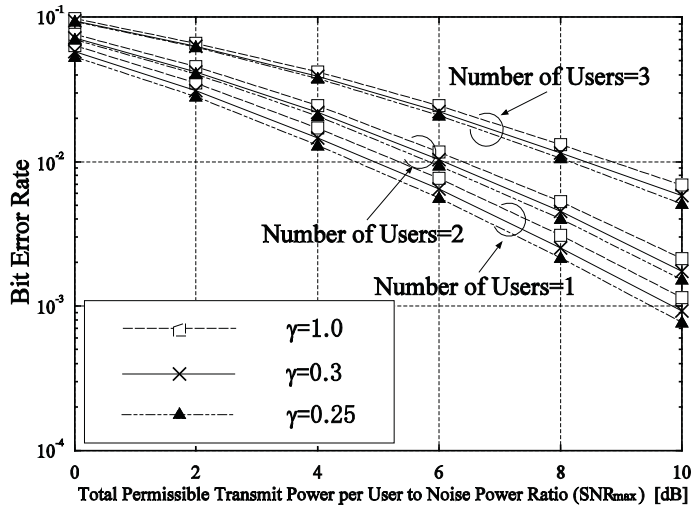

Fig. 17. Bit Error Rate Performance (K=4)

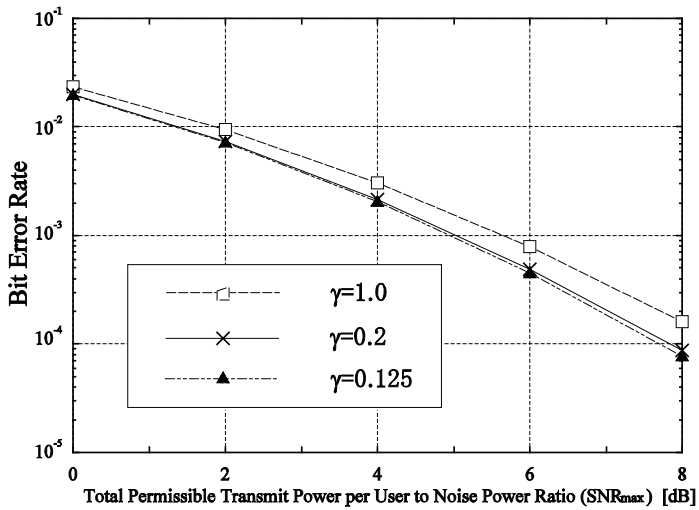

Fig. 18. Bit Error Rate Performance (K=8, N=3)

4. Conclusion

We proposed optimization algorithms of transmit and receive weights for MIMO systems, where the transmitter is equipped with a virtual MIMO channel and virtual receiver to calculate the transmitter weight. First, we proposed an iterative optimization of transmit and receive weights for E-SDM systems, where a least mean square algorithm is used to determine the weight coefficients. The proposed method can be easily extended to the case of E-SDM in MIMO system with arbitrary number of transmit and receive antennas. Second, we proposed a weight optimization method of MIMO systems under constraints of the total transmit power for all antenna elements and the maximum transmit power for an antenna element. The performance of the proposed method is evaluated for QPSK signal in MU-MIMO system with K antenna elements on the transmitter side and single antenna element at the receive side. It is clarified that the degradation of received SINR attributable to constraint of per antenna power is 0.5~1.0 dB in case where the maximum transmit power for an antenna element is limited to $1/K$ for the number of antenna of $K=4$ and 8. These results mean that the proposed optimization algorithm enables to use a low cost power amplifier at base stations in MIMO systems.

5. References

- [1] T. Ohgane, T. Nishimura, & Y. Ogawa. Applications of Space Division Multiplexing and Those Performance in a MIMO Channel, *IEICE Transactions on Communications*, vol.E88-B, no.5, pp.1843-1851, May. 2005.
- [2] G. Lebrun, J. Gao, & M. Faulkner. MIMO Transmission Over a Time-Varying Channel Using SVD, *IEEE Transactions on Wireless Communications*, vol. 4, No.2, pp. 757--764, March 2005.
- [3] J. G. Proakis. Digital Communications, Fourth Edition, *McGraw-Hill*, 2001.
- [4] S. Haykin. Adaptive Filter Theory, Fourth Edition, *Prentice Hall*, 2002.
- [5] H. Yoshinaga, M.Taromaru, & Y.Akaiwa. Performance of Adaptive Array Antenna with Widely Spaced Antenna Elements, *Proceedings of the IEEE Vehicular Technology Conference Fall'99*, pp.72-76, Sept. 1999.
- [6] T. Nishimura, Y. Takatori, T. Ohgane, Y. Ogawa, & K. Cho, Transmit Nullforming for a MIMO/SDMA Downlink with Receive Antenna Selection, *Proceedings of the IEEE VTC Vehicular Technology Conference Fall'02*, pp.190-194, Sept. 2002.
- [7] Y. Kishiyama, T. Nishimura, T. Ohgane, Y. Ogawa, & Y. Doi. Weight Estimation for Downlink Null Steering in a TDD/SDMA System, *Proceedings of the IEEE VTC Vehicular Technology Conference Spring'00*, pp.346-350, May 2000.
- [8] Y. Doi, Tadayuki Ito, J. Kitakado, T. Miyata, S. Nakao, T. Ohgane, & Y. Ogawa. The SDMA/TDD Base Station for PHS Mobile Communication, *Proceedings of the IEEE Vehicular Technology Conference Spring'02*, pp.1074-1078, May 2002.
- [9] T. Nishimura, T. Ohgane, Y. Ogawa, Y. Doi, & J. Kitakado. Downlink Beamforming Performance for an SDMA Terminal with Joint Detection, *Proceedings of the IEEE Vehicular Technology Conference Fall'01*, pp.1538-1542, Oct. 2001.
- [10] B. S. Krongold. Optimal MIMO-OFDM Loading with Power-Constrained Antennas, *Proceedings of the IEEE PIMRC'06*, Sept. 2006.

- [11] S. S. Rao. Engineering Optimization, Theory and Practice, 3rd Edition, *Wiley-Interscience*, 1996.



MIMO Systems, Theory and Applications

Edited by Dr. Hossein Khaleghi Bizaki

ISBN 978-953-307-245-6

Hard cover, 488 pages

Publisher InTech

Published online 04, April, 2011

Published in print edition April, 2011

In recent years, it was realized that the MIMO communication systems seems to be inevitable in accelerated evolution of high data rates applications due to their potential to dramatically increase the spectral efficiency and simultaneously sending individual information to the corresponding users in wireless systems. This book, intends to provide highlights of the current research topics in the field of MIMO system, to offer a snapshot of the recent advances and major issues faced today by the researchers in the MIMO related areas. The book is written by specialists working in universities and research centers all over the world to cover the fundamental principles and main advanced topics on high data rates wireless communications systems over MIMO channels. Moreover, the book has the advantage of providing a collection of applications that are completely independent and self-contained; thus, the interested reader can choose any chapter and skip to another without losing continuity.

How to reference

In order to correctly reference this scholarly work, feel free to copy and paste the following:

Osamu Muta, Takayuki Tominaga, Daiki Fujii, and Yoshihiko Akaiwa (2011). Iterative Optimization Algorithms to Determine Transmit and Receive Weights for MIMO Systems, MIMO Systems, Theory and Applications, Dr. Hossein Khaleghi Bizaki (Ed.), ISBN: 978-953-307-245-6, InTech, Available from:
<http://www.intechopen.com/books/mimo-systems-theory-and-applications/iterative-optimization-algorithms-to-determine-transmit-and-receive-weights-for-mimo-systems>

INTECH

open science | open minds

InTech Europe

University Campus STeP Ri
Slavka Krautzeka 83/A
51000 Rijeka, Croatia
Phone: +385 (51) 770 447
Fax: +385 (51) 686 166
www.intechopen.com

InTech China

Unit 405, Office Block, Hotel Equatorial Shanghai
No.65, Yan An Road (West), Shanghai, 200040, China
中国上海市延安西路65号上海国际贵都大饭店办公楼405单元
Phone: +86-21-62489820
Fax: +86-21-62489821

© 2011 The Author(s). Licensee IntechOpen. This chapter is distributed under the terms of the [Creative Commons Attribution-NonCommercial-ShareAlike-3.0 License](#), which permits use, distribution and reproduction for non-commercial purposes, provided the original is properly cited and derivative works building on this content are distributed under the same license.