

Adaptive Fuzzy Modelling and Control for Non-Linear Systems Using Interval Reasoning and Differential Evolution

Jiangtao Cao¹, Ping Li¹ and Honghai Liu²

¹*Liaoning Shihua University,*

²*University of Portsmouth*

¹*China*

²*United Kingdom*

1. Introduction

Fuzzy systems have been developed to a major scientific domain since fuzzy set theory was introduced by Zadeh about four decades ago (Zadeh, 1965). There are certain particular properties of fuzzy systems that offer them better performance for specific applications. In general, fuzzy systems are suitable for uncertain or approximate reasoning, allow decision making with estimated values under incomplete information and represent descriptive or qualitative expressions which are easily incorporated with symbolic statements (Klir & Folger, 1987). However, under the general framework of typical fuzzy systems, some kinds of uncertainty cannot be handled, particularly in practical applications (Mendel & John, 2002; Ross, 2004; Hagra, 2004). Therefore, further flexibility can be obtained by considering the uncertainty in fuzzy systems which occur from qualitative knowledge and stochastic information.

As mentioned in (Mendel & John, 2002; Hagra, 2004; Liu & Li, 2005a), most of uncertainties in fuzzy systems can be embodied by the information of fuzzy membership functions. In order to expand fuzzy systems to solve more complex uncertainty, some novel methods have been proposed during recent decade. Type-2 fuzzy logic system (T2FLS) was proposed to model and control further uncertainties in typical fuzzy systems by using the secondary fuzzy membership functions (Karnik & Liang, 1999; Liang & Mendel, 2000a). The T2FLS was originally inspired by the fact that the typical FLS limits introducing uncertain factors from linguistic rules through predefined membership functions. The type-2 fuzzy methods can be roughly described that their fuzzy sets are further defined by the typical fuzzy membership functions, i.e., the membership degree of belonging for each element of these sets are fuzzy sets, not a crisp number (Liang & Mendel, 2000b; Karnik & Mendel, 2001; Wu & Mendel, 2009). In comparison with the typical FLS, a type-2 FLS has the two-fold advantages as follows. Firstly, it has the capability of directly handling the uncertain factors of fuzzy rules caused by expert experience or linguistic description. Secondly, it is efficient to employ a

⁰:Supported by Program for Liaoning Science and Technology Innovative Research Team in University(2007T103,LT2010058), the Program for Liaoning Excellent Talents in University(2008RC32) and a full PhD scholarship at University of Portsmouth, UK.

type-2 FLS to cope with scenarios in which it is difficult or impossible to determine an exact membership function and related measurement of uncertainties. These strengths have made researchers consider type-2 FLS as the preference for real-world applications (Sepúlveda et al., 2007; Astudillo et al., 2007).

From the viewpoint of real-time application, many researchers use interval type-2 fuzzy sets to solve the computational complexity of general type-2 fuzzy sets and have brought some application results (Wu & Mendel, 2002; Julio & Alberto, 2007). However, the computational expense on type reduction of type-2 FLS also is a bottleneck to use an type-2 FLS for real-time control applications (Mendel, 2007). Some new alternative ways have been provided to reduce the computational expense and to promote the applications (Castro et al., 2008; Hagra, 2008; Nie & Tan, 2008; Cao et al., 2008). Up to now, how to design an efficient type-2 FLS with less calculation and strong adaptive ability to overcome uncertainty of industrial control is still an open question.

By introducing the probabilistic information into fuzzy membership functions, the Probabilistic Fuzzy Logic Systems (PFLS) were established to handle stochastic uncertainties which occurred in complex plant dynamics (Liu & Li, 2005a;b). The mathematical expectation of fuzzy output centroid was calculated to perform defuzzification of PFLS. In spite of many research results, the problem of systematic handling uncertainty of fuzzy system has not yet been completely resolved.

In this paper, firstly, a systematic design method of extended fuzzy logic system (EFLS) is represented for engineering applications based on our previous research (Cao et al., 2009). By introducing the degree of uncertainty in membership functions, the EFLS can not only make use of typical fuzzy system which has been well developed, but also can expand its capability of handling uncertainty in complex circumstance. In the EFLS, the process is similar to conventional fuzzy system which includes fuzzification, inference engine and defuzzification. But in each part of this process, the operation methods are different. In the fuzzification, the EFLS uses the interval membership functions which are generated from typical membership functions. The inference engine is separated into two parts which perform fuzzy reasoning on inner and outer fuzzy subsystems, respectively. In the defuzzification, the outputs are calculated by weighted outputs of subsystems with novel adaptive optimal algorithm and feedback structure.

Secondly, under the above framework of EFLS, the adaptive fuzzy control system is designed to deal with the uncertainties from complex dynamics of control plant by integrating the global optimization method : Differential Evolution (DE). The main difference in this adaptive control system is the defuzzification part. For dealing with the variable control target and solving the nonlinear optimization performance, the crisp outputs are derived from the interval of outputs of subsystems by the DE optimization method. For evaluating the framework of EFLS, it is applied on the inverse kinematics modelling problem of a two-joint robotic arm. The adaptive fuzzy control system is implemented on a typical nonlinear quarter car active suspension system.

The paper is organized as follows. In Section 2 the interval fuzzy membership functions with degree of uncertainty are addressed. A systematic design method based on interval fuzzy membership functions and adaptive optimal algorithm is represented in Section 3. The novel adaptive fuzzy control system with DE method is designed in Section 4. Simulations on the two-joint robotic arm and the quarter car active suspension system are investigated in Section 5, finally the paper is concluded with concluding remarks and future work in Section 6.

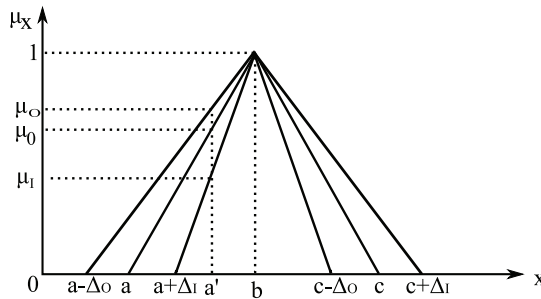

Fig. 1. Degree of uncertainty in fuzzy membership function

2 Interval fuzzy membership function generation methods

Although fuzzy systems have been used in different scientific and engineering applications, the phenomenon of uncertainty in typical fuzzy systems has been studied and some novel methods have been proposed to cover more uncertainties. Type-2 fuzzy methods expanded the typical fuzzy systems by a secondary membership function. The PFLS methods proposed the probabilistic fuzzy membership functions to represent the stochastic uncertainty in fuzzy systems. However, it is still a difficult task to completely solve all problems caused by uncertainty in fuzzy systems.

Generally, there are three types of uncertainty which mainly occur in conventional fuzzy methods. First type is uncertainty due to variability of inputs and/or model parameters. Second type is uncertainty due to understanding of linguistic knowledge and quantification of fuzzy rules. Third type is uncertainty due to unknown process and/or unmodelled dynamics. In this section, by introducing the degree of uncertainty in fuzzy membership function, interval membership function generation method is proposed to build proper membership functions for covering possible uncertain information.

2.1 Degree of uncertainty in fuzzy membership function

Considering the natural property of uncertainty, there are many different methods to quantitatively describe it. Generally, there are three kinds of methods to quantify uncertainty. One is margin of uncertainty which is stated by giving a range of values around true value. The other is standard deviation of estimate value by repeating measurement enough times. The third one is fuzzy presentation by fuzzy sets and fuzzy rules. The second method has been used in PFLS and the third method was used in type-2 fuzzy systems. Here, the first method is used to define a margin of uncertainty for membership function which is called degree of uncertainty in fuzzy membership function. In this paper, the degree of uncertainty is used to describe possible uncertainty which is inherent in fuzzy membership functions.

As an example, a triangle membership function with degree of uncertainty is shown in Fig.1. For implementation, the center triangle membership function can be presented as $[a, b, c]$. It is deduced by expert knowledge or any training methods of fuzzy membership function. With degree of uncertainty, the proposed fuzzy membership function belongs to a bounded region which the outer and inner boundaries of membership function can be presented as $[a - \Delta_O, b, c + \Delta_O]$ and $[a + \Delta_I, b, c - \Delta_I]$. Here, Δ_O and Δ_I are defined as bounded values of uncertainty in fuzzy membership function and their values can be adaptive tuned by proposed method in Section 3. The inner and outer degrees of uncertainty are defined in equation 1.

$$\alpha = \frac{\Delta_O}{\Delta_O + \Delta_I}, \beta = \frac{\Delta_I}{\Delta_O + \Delta_I} \tag{1}$$

With the membership function $[a, b, c]$, the membership grade of crisp input a' is μ_0 . However, with proposed interval membership function, the membership grade belongs to an interval domain $[\mu_I, \mu_O]$. The exact grade will depend on the bounded uncertainty and the proposed fuzzy system in Section 3.

2.2 Interval fuzzy membership functions

The proposed method simply uses an appropriate predefined typical fuzzy membership functions, such as triangular, trapezoidal, Gaussian, or S functions, to expand to the interval fuzzy membership functions with the degree of uncertainty. The following is an example of triangular membership function which can be expanded to interval membership function from typical membership function.

The typical triangular fuzzy membership function is

$$\mu(x; a, b, c) = \begin{cases} 0 & x \leq a \\ \frac{x-a}{b-a} & a \leq x \leq b \\ \frac{c-x}{c-b} & b \leq x \leq c \\ 0 & x \geq c \end{cases} \tag{2}$$

Based on the above fuzzy membership function, with the defined degree of uncertainty in Section 2.1, the interval fuzzy membership function can be represented as below.

$$\mu(x; a, b, c) = \begin{cases} 0 & x \leq a - \Delta_O \\ \frac{x-a+\Delta_O}{b-a+\Delta_O} & a - \Delta_O \leq x \leq a + \Delta_I \\ \left[\frac{x-a-\Delta_I}{b-a-\Delta_I}, \frac{x-a+\Delta_O}{b-a+\Delta_O} \right] & a + \Delta_I \leq x \leq b \\ \left[\frac{c-\Delta_I-x}{c-\Delta_I-b}, \frac{c+\Delta_O-x}{c+\Delta_O-b} \right] & b \leq x \leq c - \Delta_I \\ \frac{c+\Delta_O-x}{c+\Delta_O-b} & c - \Delta_I \leq x \leq c + \Delta_O \\ 0 & x \geq c + \Delta_O \end{cases} \tag{3}$$

3. Systematic design of extended fuzzy logic system

A framework of EFLS for fuzzy modelling is proposed as Fig. 2. Similar to the typical FLS (Ross, 2004), the EFLS still has operations of fuzzification, inference engine and defuzzification. Different with the typical FLS, the EFLS uses the interval fuzzy membership functions which can be generated from typical fuzzy membership function. Thus the membership grade for the crisp input belongs to an interval which aims to expand the typical fuzzy sets to cover more uncertain information in practical applications. Considering the computational cost, the inference engine of EFLS is separated into two parts and the reasoning results are presented by two typical boundary FLSs. With the fuzzy interval reasoning results, a novel adaptive algorithm is established to transfer them into expected crisp output.

3.1 Fuzzification of EFLS

Considering a T-S fuzzy model represented as the general form:

$R^{(k)}$: IF z_1 is F_1^k and z_2 is $F_2^k, \dots,$ and z_m is $F_m^k,$ THEN $x(t + 1)$ is $g^k(X, U)$, here, $k \in K := 1, 2, \dots, n$

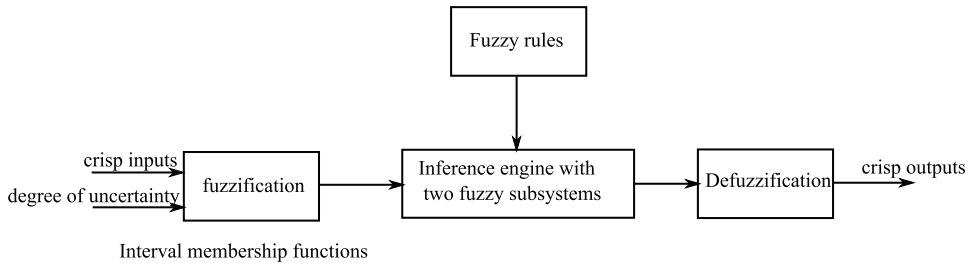

Fig. 2. The framework of interval fuzzy logic system

Here R^k denotes the k th fuzzy rule, n denotes the number of fuzzy rules, m denotes the number of input variables, $F_j^k(j = 1, 2, \dots, m) = (F_j^k(inner), F_j^k(outer))$ denote the proposed interval fuzzy sets as shown in Section 2, $z(t) := [z_1, z_2, \dots, z_m]$ denote measurable variables, $x(t) \in \mathbb{R}^n$ denotes the state vector, $u(t) \in \mathbb{R}^p$ denotes the input vector, and the T-S consequent term g_j^k is defined in equation 4.

$$g^k(X, U; \theta^k) = A_k x(t) + B_k u(t) \quad (4)$$

$$k \in K := 1, 2, \dots, n$$

where A_k and B_k are the parameter matrices of the k th local model.

Different with other fuzzy systems, the fuzzification of EFLS requires the predefined outer and inner degrees of uncertainty in fuzzy membership functions, that is α, β which can be defined by expert knowledge or the measurement data and predicted error boundary. These degrees of uncertainty are used to present the possible uncertainty due to the understanding of linguistic knowledge or unknowing system dynamic in fuzzy system. The structure of fuzzification is shown in Fig. 3. And all the degrees can be self-tuned by proposed adaptive algorithm in Section 3.3.

Based on these degrees of uncertainty and typical fuzzy sets, a crisp input variable is transferred into two fuzzy membership grades which belong to an interval region. From practice viewpoint, a bounded region of fuzzy membership grade will be more flexible to cover uncertain information.

3.2 Inference engine in EFLS

With the proposed fuzzification, each crisp input variable is changed to fuzzy value which relates to two fuzzy membership grades in a bounded fuzzy set. The fuzzy inference engine is separated into two parts to perform fuzzy reasoning on the inner boundary fuzzy subsystem S_{inner} and the outer boundary fuzzy subsystem S_{outer} as shown in Fig. 4. With the fixed fuzzy membership functions $F_j^k(inner)$ and $F_j^k(outer)$, typical fuzzy inference engines are used to perform fuzzy reasoning with the same fuzzy rules. However, since the degree of

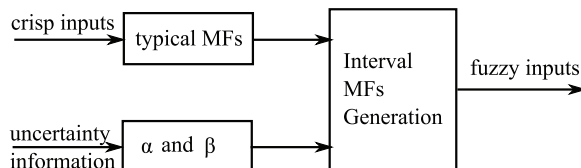

Fig. 3. The interval membership functions(MFs) generation

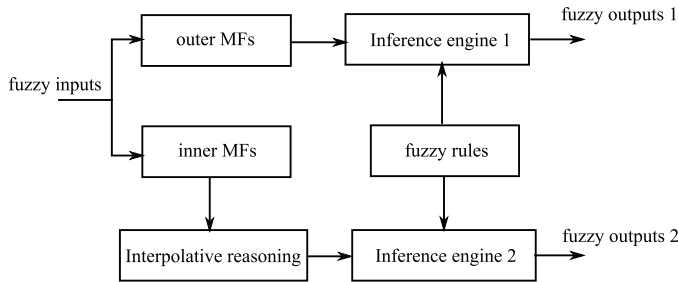

Fig. 4. The inference engine of EFLS

uncertainty is tuned in real time, the inner boundary fuzzy subsystem possibly becomes a sparse fuzzy rule-based system. That's means, for some inputs, their fuzzy sets are not defined or their fuzzy membership grade can't covered by neighbourhood membership functions. In order to deal with these problems, there have been many fuzzy interpolative reasoning methods for the sparse fuzzy systems (Baranyi et al., 2004; Huang & Shen, 2006; Lee & Chen, 2008). Considering the overlapping phenomenon in the inner boundary fuzzy subsystem, the method in (Lee & Chen, 2008) is used.

With the fuzzy rules in Section 3.1, the firing strength of the k th rule can be described as:

$$\mu_k^I = \mu_{F_1^k}^I * \mu_{F_2^k}^I * \dots * \mu_{F_i^k}^{I(*)} * \dots * \mu_{F_m^k}^I \geq 0 \tag{5a}$$

$$\mu_k^O = \mu_{F_1^k}^O * \mu_{F_2^k}^O * \dots * \mu_{F_m^k}^O \geq 0 \tag{5b}$$

in which $\mu_k^I \in [0,1]$ and $\mu_k^O \in [0,1]$ denote the inner and outer grades of membership governed by the inner and outer fuzzy membership functions, respectively. Furthermore, $\mu_{F_i^k}^{I(*)}$ denotes the interpolative grade by the interpolative reasoning method. The fuzzy inference logic employs the max-min product to operate the fuzzy rules. The reasoning results are two fuzzy values which are deduced from two fuzzy subsystems.

3.3 Defuzzification and adaptive algorithm

The centroid calculation is used to obtain crisp outputs from two fuzzy reasoning results by typical defuzzification. Each crisp output corresponds to one bounded fuzzy subsystem. The two boundary outputs can be written as

$$\begin{aligned} x^I(t+1) &= \frac{\sum_{k=1}^n \mu_k^I [A_k x(t) + B_k u(t)]}{\sum_{k=1}^n \mu_k^I} \\ &= \sum_{k=1}^n h_k^I [A_k x(t) + B_k u(t)] \end{aligned} \tag{6a}$$

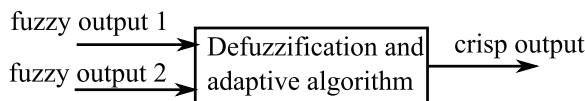

Fig. 5. The defuzzification of EFLS

$$\begin{aligned}
 x^O(t+1) &= \frac{\sum_{k=1}^n \mu_k^O [A_k x(t) + B_k u(t)]}{\sum_{k=1}^n \mu_k^O} \\
 &= \sum_{k=1}^n h_k^O [A_k x(t) + B_k u(t)]
 \end{aligned}
 \tag{6b}$$

where

$$h_k^I = \frac{\mu_k^I}{\sum_{k=1}^n \mu_k^I}, h_k^O = \frac{\mu_k^O}{\sum_{k=1}^n \mu_k^O}
 \tag{7}$$

And,

$$\begin{aligned}
 h_k^I \geq 0, h_k^O \geq 0, k = 1, 2, \dots, n \\
 \sum_{i=1}^n h_k^I = 1, \sum_{i=1}^n h_k^O = 1
 \end{aligned}
 \tag{8}$$

For interpreting the uncertain information inherent in these two subsystems, an adaptive algorithm is established to get final crisp outputs. The algorithm can be presented as follows. Let $y_I = x^I(t+1)$ and $y_O = x^O(t+1)$,

$$e_O = y^* - y_O, e_I = y^* - y_I
 \tag{9}$$

here, y^* is the reference value, measurement value or objective function for system modelling. Let $\tilde{e}_I = |e_I|$ and $\tilde{e}_O = |e_O|$, the crisp output of EFLS is

$$y = f(y_O, y_I) = \frac{\tilde{e}_O}{\tilde{e}_O + \tilde{e}_I} y_I + \frac{\tilde{e}_I}{\tilde{e}_O + \tilde{e}_I} y_O
 \tag{10}$$

The system error is

$$e = y^* - y
 \tag{11}$$

In order to tune the degree of uncertainty to deal with uncertainties, the adaptive algorithm is presented as follows.

If the condition is

$$e_O e_I < 0, \text{ and } \tilde{e}_O > \tilde{e}_I
 \tag{12}$$

then the inner degree of uncertainty is kept as the same, and the outer degree of uncertainty will be tuned as

$$\alpha = (1 - \Delta\alpha)\alpha
 \tag{13}$$

here,

$$\Delta\alpha = \eta_O \cdot \frac{\tilde{e}_O}{\tilde{e}_O + \tilde{e}_I}
 \tag{14}$$

and η_O is the tuning factor for the outer subsystem. If the condition is

$$e_O e_I < 0, \text{ and } \tilde{e}_O < \tilde{e}_I
 \tag{15}$$

then the outer degree of uncertainty is kept as the same, and the inner degree of uncertainty will be tuned as

$$\beta = (1 - \Delta\beta)\beta
 \tag{16}$$

here,

$$\Delta\beta = \eta_I \cdot \frac{\tilde{e}_I}{\tilde{e}_O + \tilde{e}_I}
 \tag{17}$$

and η_I is the tuning factor for the inner subsystem. If the condition is

$$e_O e_I > 0, \text{ and, } \tilde{e}_O > \tilde{e}_I \quad (18)$$

then the outer degree of uncertainty is kept as the same, and the inner degree of uncertainty will be tuned as

$$\beta = (1 + \Delta\beta)\beta \quad (19)$$

here, $\Delta\beta$ can be solved by equation 17.

If the condition is

$$e_O e_I > 0, \text{ and, } \tilde{e}_O < \tilde{e}_I \quad (20)$$

then the inner degree of uncertainty is kept as the same, and the outer degree of uncertainty will be tuned as

$$\alpha = (1 + \Delta\alpha)\alpha \quad (21)$$

here, $\Delta\alpha$ can be solved by equation 14.

Once the outer and inner degree of uncertainty are tuned to new values, by solving the equation 1, the new values of Δ_O and Δ_I are obtained. Then the new bounded region for uncertainty is rebuilt.

3.4 Systematic design of EFLS

With the information of section 3.1-3.3, a systematic procedure is obtained to design the EFLS for system modelling.

- Step 1) Determine the state variables, their typical fuzzy membership functions and fuzzy rules.
- Step 2) Define the degrees of uncertainty in membership functions and build the interval membership functions for all the input variables by equations 1-3.
- Step 3) Obtain the input and output data of modelled process.
- Step 4) Calculate the fuzzy reasoning results by equation 10 and the system error by equation 11.
- Step 5) Perform on-line adaptive algorithm to update the degree of uncertainty by equations 12-21. Then back to the second step to rebuild the interval membership functions and recalculate the system outputs. Recycle this process until that system error reduces to an expected region.

4. Adaptive fuzzy control system

With the above systematic design of EFLS, a novel general framework of interval fuzzy reasoning system has been built. From the point of control system design, by implementing the DE to optimize the control performance on the interval reasoning results, an adaptive control structure is proposed in this section.

4.1 Design of the adaptive control system

Based on the reasoning results from subsystems as equations 6a- 6b, the further optimization process can be designed to find the optimal values which satisfy the required control performance. This adaptive control structure aims to rebuild the switching routes between the local subsystems.

With the proposed adaptive control structure, the crisp outputs of the control system can be recalculated as,

$$\underline{u}_c^* = \min \{x^I(t), x^O(t)\} \tag{22a}$$

$$\overline{u}_c^* = \max \{x^I(t), x^O(t)\} \tag{22b}$$

$$\Gamma = f(\tilde{u}(t))$$

$$\tilde{u}(t) \in (\underline{u}_c^* + \Delta u_c^*, \underline{u}_c^* + 2\Delta u_c^*, \dots, \overline{u}_c^*) \tag{22c}$$

$$\Delta u_c^* = \frac{\overline{u}_c^* - \underline{u}_c^*}{n} \tag{23}$$

where $x^I(t)$ and $x^O(t)$ can be calculated from equations 6a and 6b, n denotes the re-sampling number, Γ denotes the further optimization goal, f is defined as a performance function of the system with variable $\tilde{u}(t)$. The control output $\tilde{u}(t)$ can be solved from equation 22c by the global optimization algorithm: DE algorithm. For clearly showing the details of optimal process, the DE method is represented in Section 4.2.

4.2 Differential evolution algorithms

DE method, recently proposed by Storn (Storn & Price, 1997), is one kind of evolutionary algorithms(EAs) which are a class of direct search algorithms. The main advantage of DE method is to converge fast and to avoid being trapped by local minim. It has been applied to several engineering problems in different areas(Storn, 1999; Abbass, 2002; Price et al., 2005; Brest et al., 2006). The main difference between the DE method and other EAs is the mutation scheme that makes DE self adaptive the selection process. In DE algorithms, all solutions have the same chance of being selected as parents without dependence of their fitness value. DE algorithm employs a greedy selection process: The better one of new solution and its parent wins the competition providing significant advantage of converging performance over other EAs (Karaboga et al., 2004).

As a population based algorithm, DE algorithms uses the similar operators as the genetic algorithms: crossover, mutation and selection. The main difference is that genetic algorithms rely on crossover while DE algorithm relies on mutation operation. The DE algorithm also uses a non-uniform crossover that can take child vector parameters from one parent more often than it does from others. By using the components of the existing population members to construct trial vectors, the crossover operator efficiently shuffles information about successful combinations, enabling the search for a better solution space.

The main steps of the DE algorithm is given below(Karaboga et al., 2004):

- Initialization
- Evaluation
- Repeat
 - Mutation
 - Recombination
 - Evaluation
 - Selection
- Until(termination criteria are met)

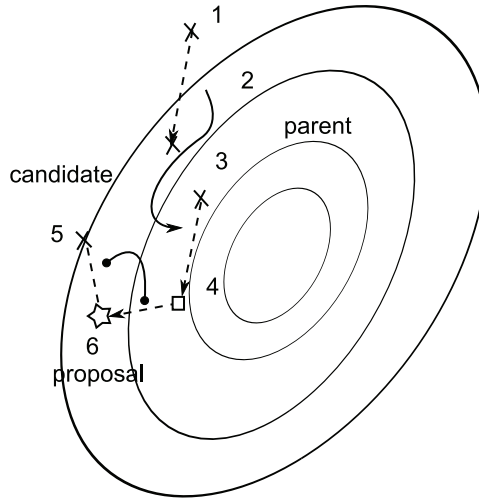

Fig. 6. Obtaining a new proposal in DE algorithm (Karaboga et al., 2004)

4.2.1 Mutation

For each target vector $x_{i,G}$, a mutant vector is produced by

$$u_{i,G+1} = x_{i,G} + K \cdot (x_{r1,G} - x_{i,G}) + F \cdot (x_{r2,G} - x_{r3,G}) \quad (24)$$

where $i, r1, r2, r3 \in 1, 2, \dots, NP$ are randomly chosen and must be different from each other. In 24, F is the scaling factor which has an effect on the difference vector $(x_{r2,G} - x_{r3,G})$, K is the combination factor.

4.2.2 Crossover

The parent vector is mixed with the mutated vector to produce a trial vector $u_{ji,G+1}$ as below.

$$u_{ji,G+1} = \begin{cases} v_{ji,G+1} & \text{if } (rnd_j \leq CR) \text{ or } j = rn_i \\ q_{ji,G} & \text{if } (rnd_j > CR) \text{ and } j \neq rn_i \end{cases} \quad (25)$$

where $j = 1, 2, \dots, D$; $rnd_j \in [0, 1]$ is the random number; CR is crossover constant $\in [0, 1]$ and $rn_i \in (1, 2, \dots, D)$ is the randomly chosen index.

4.2.3 Selection

All solutions in the population have the same chance of being selected as parents without dependence of their fitness value. The child produced after the mutation and crossover operations is evaluated. Then, the performance of the child vector and its parent is compared and the better one is selected. If the parent is still better, it is retained in the population.

Figure 6 shows DE algorithm process in detail. The difference between two population members (1,2) is added to a third population member (3). The result (4) is subject to the crossover with the candidate for replacement (5) to obtain a proposal (6). The proposal is evaluated and replaces the candidate if it is found to be better.

4.3 Systematic design of adaptive fuzzy control system

With the above information, the systematic control procedure of proposed method is obtained as follows.

- Step 1) Determine all the state variables, their typical fuzzy MFs and fuzzy rules.
- Step 2) Define the degrees of uncertainty in membership functions and build the interval membership functions for all the input variables by equations 1-3.
- Step 3) With the control plant and required control aims, design the optimization task and the related parameters for the DE algorithm.
- Step 4) Obtain the system inputs, the interval outputs are calculated with the proposed EFLS by equations 5a- 6b.
- Step 5) Calculate the fuzzy control outputs by further optimization structure with equations 22a - 23.
- Step 5) Perform the control outputs on the plant, the system inputs are updated and the system performance in further optimization part are also recalculated.
- Step 6) Return to the Step 4) to do the next interval fuzzy reasoning. Recycle this process until the expected system performance is obtained.

In comparison with the existed type-2 fuzzy control systems and PFLS, the proposed structure build a more general framework to represent the fuzzy modelling and control process. Under the proposed structure, the crisp output of the EFLS and the related control system represent two-fold information. One is the fuzzy rules which are extracted from expert knowledge or industrial experience. The other is the further optimal goal which is required by practical issues or is impossible to be combined into the fuzzy rules. With the optimization algorithms, the control performance will be improved and the optimal goal can be flexibly designed. For the purpose of evaluating the proposed structure, a inverse kinematics modelling of a two-joint robotic arm and a case study on a non-linear quart-vehicle active suspension system are presented in Section 5.

5. Simulations

5.1 Modelling by EFLS

In order to demonstrate the performance of proposed EFLS, the numerical simulations have been carried out on the inverse kinematics modelling of a two-joint robotic arm (Gan et al., 2005). The model of robotic arm is presented in Fig. 7.

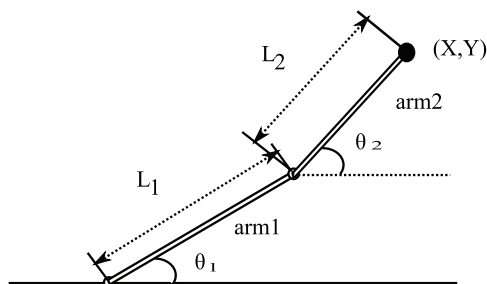

Fig. 7. The two-joint robotic arm with two angles

l	S_1	S_2	S_3
B_1	1	4	7
B_2	2	5	8
B_3	3	6	9

Table 1. The Antecedents of Fuzzy Rules

The inverse kinematics modelling is a typical problem in robotics. In a two-dimensional input space, with a two-joint robotic arm and the desired location, the problem reduces to find the angles between arms. For simple structures of the two-joint robotic arm, its dynamics is described as the following dynamical equations:

$$c_1 = \frac{x^2 + y^2 - L_1^2 - L_2^2}{2L_1L_2} \quad (26a)$$

$$c_2 = \sqrt{1 - c_1^2}, c_3 = L_1 + L_2c_1, c_4 = L_2c_2 \quad (26b)$$

$$\theta_1 = \arctan \frac{Y}{X} - \arctan \frac{c_4}{c_3} \quad (26c)$$

$$\theta_2 = \arctan \frac{c_2}{c_1} \quad (26d)$$

where, X, Y are the desired location, θ_1 and θ_2 are the corresponded angles as shown in Fig.7. The parameters are chosen as: $L_1 = 8$ and $L_2 = 5$.

With the fuzzy toolbox of MATLAB, the typical fuzzy system for this inverse kinematics problem is established which membership functions have been decided by hybrid neuro-fuzzy learning algorithm. Based on this typical fuzzy system, the proposed EFLS is designed. The inputs are the desired locations which are presented by the data pair (X, Y) . Their typical membership functions are shown in Fig. 8 and Fig.9. The original uncertain margins are chosen as $\Delta_I = 0.4$ and $\Delta_O = 0.4$. The outputs are two angles. By the T-S fuzzy model, the fuzzy rules are described as:

$R^{(l)}$: IF X is S_p^l and Y is B_q^l , THEN $\theta_1 = c_1^l X + c_2^l Y + c_3^l$, $\theta_2 = d_1^l X + d_2^l Y + d_3^l$, here, $l = 1, 2, \dots, 9$, $p = 1, 2, 3$ and $q = 1, 2, 3$.

The antecedents are shown in TABLE 3 and the consequents are shown in TABLE 2.

The true values of angles are solved from equations 26a-26d. The predicted angles are obtained by the typical fuzzy system and the proposed EFLS, respectively. The comparisons of modelling results are performed by the error of predicted angles. For evaluating performance of the proposed EFLS, the inverse kinematics with or without noise are modelled and the predicted errors of two angles are shown in Fig.10-Fig.13.

According to the comparison of modelling errors in Fig.10 and Fig. 11, the proposed EFLS improved typical FLS to obtain better non-linear model of inverse kinematics. Also Fig.12 and Fig.13 both showed that robust and adaptive ability of the proposed EFLS was stronger than the typical FLS.

The simulation results have demonstrated the proposed EFLS can deal well with non-linear model and expanded the typical fuzzy system to handle uncertainty in complex circumstance.

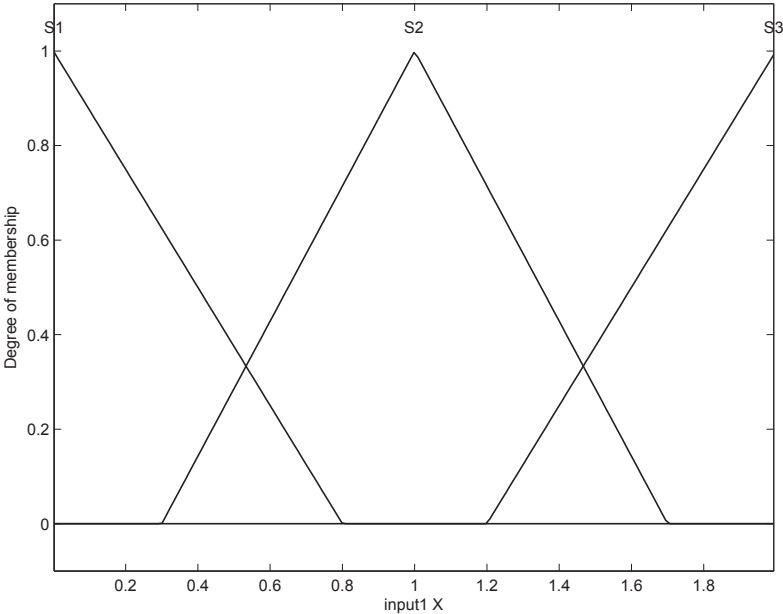

Fig. 8. The fuzzy membership functions of input X

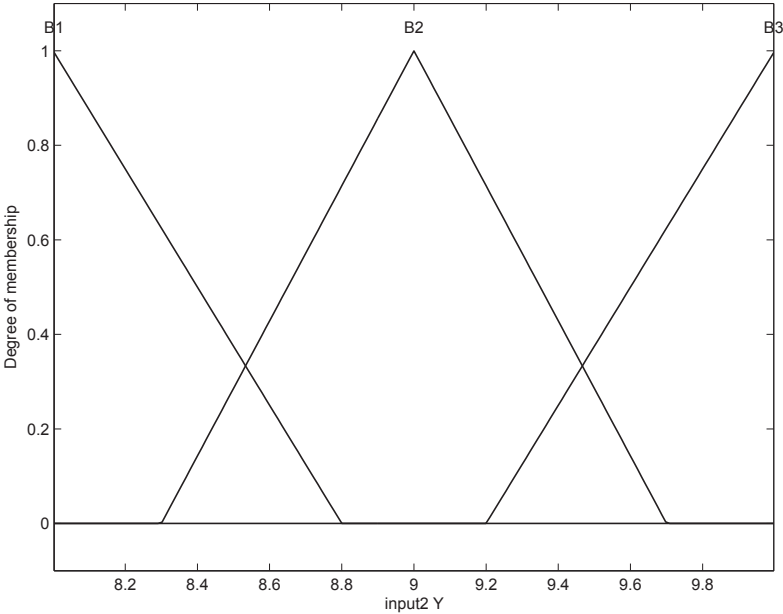

Fig. 9. The fuzzy membership functions of input Y

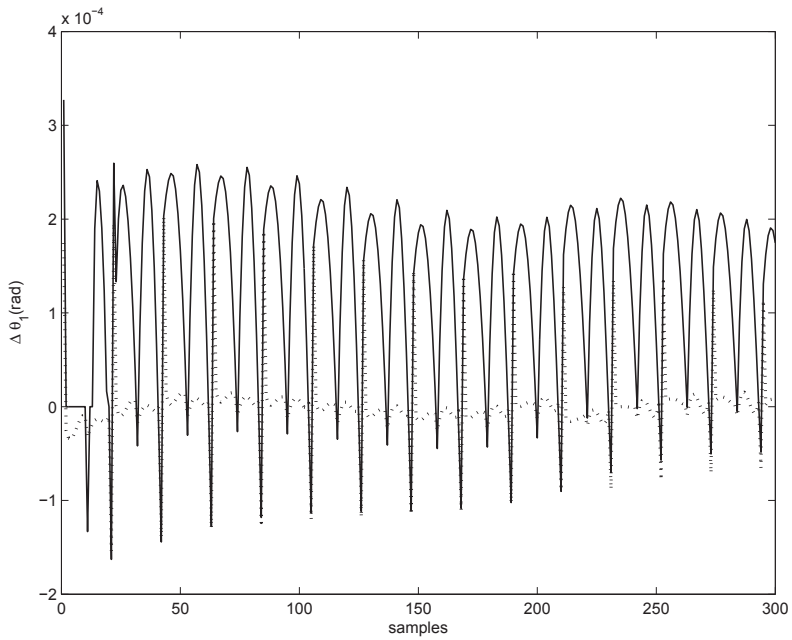

Fig. 10. The angle error of θ_1 by typical FLS(solid line) and EFLS(dot line)

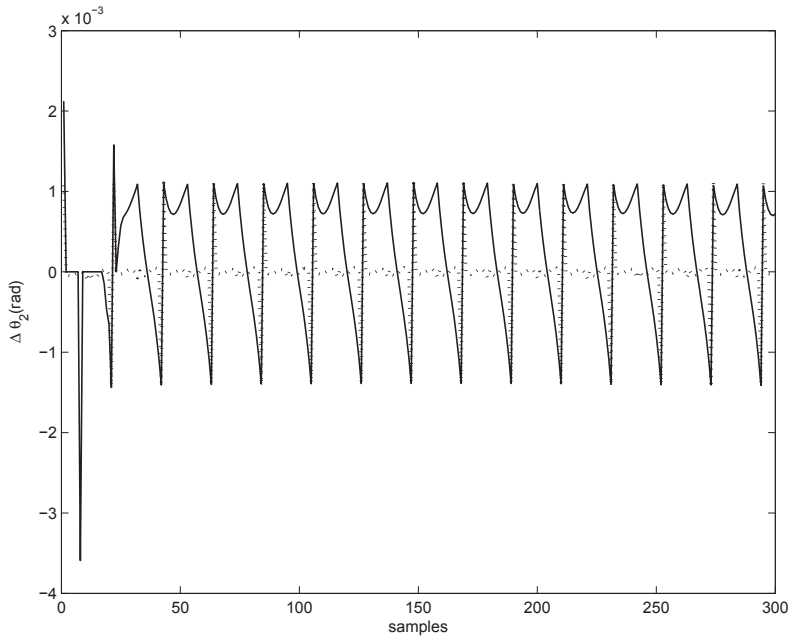

Fig. 11. The angle error of θ_2 by typical FLS(solid line) and EFLS(dot line)

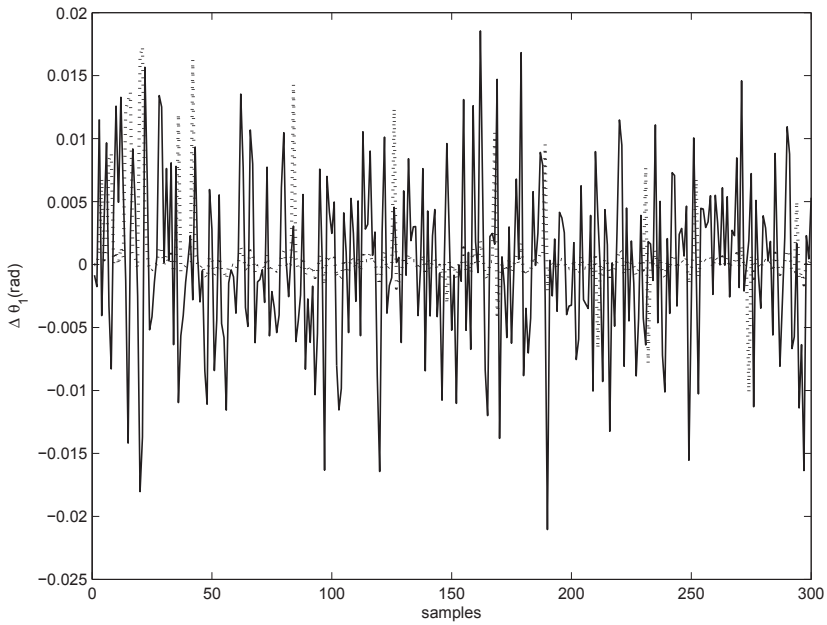

Fig. 12. The angle error of θ_1 by type-1 FLS(solid line) and EFLS(dot line) with random noise

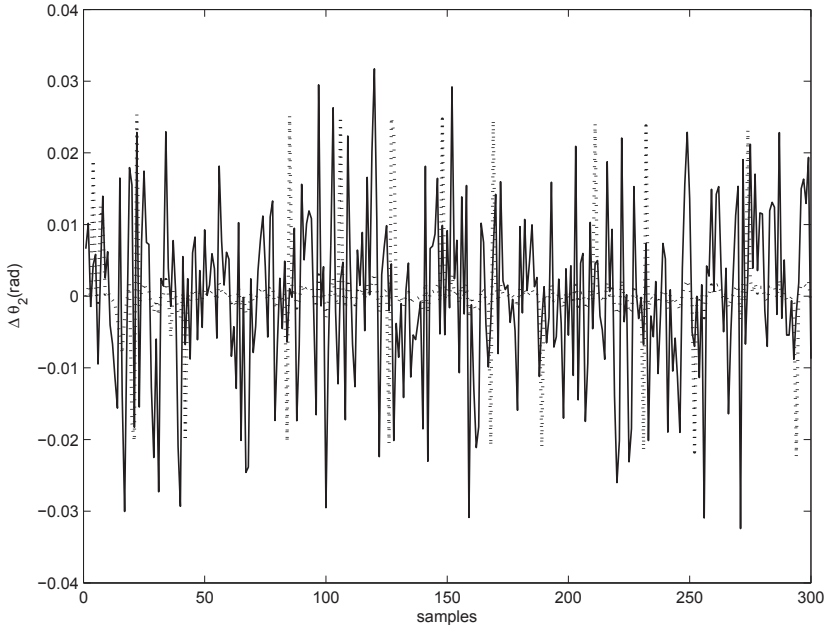

Fig. 13. The angle error of θ_2 by type-1 FLS(solid line) and EFLS(dot line) with random noise

l	c_1^l	c_2^l	c_3^l	d_1^l	d_2^l	d_3^l
1	-0.12	0.09	0.16	-0.01	0.19	0.36
2	-0.11	0.11	0.03	-0.01	0.18	0.03
3	-0.09	0.12	-0.11	-0.01	0.17	-0.26
4	-0.12	0.09	0.14	-0.03	0.19	0.35
5	-0.10	0.11	0.03	-0.03	0.18	0.28
6	-0.09	0.12	-0.10	-0.02	0.17	-0.26
7	-0.11	0.10	0.13	-0.04	0.19	0.35
8	-0.09	0.11	0.02	-0.04	0.19	0.03
9	-0.09	0.11	-0.09	-0.04	0.17	-0.25

Table 2. The Consequents of Fuzzy Rules

5.2 Control by the adaptive fuzzy control system and DE

For evaluating the performance of proposed adaptive fuzzy control system, the numerical simulations have been carried out on a quarter vehicle active suspension system as shown in Fig. 14 whose mathematical model was given in (Cao et al., 2008). Parameters of the model are provided in Table 3, partly from (Taghirad & Esmailzadeh, 1998).

The vehicle body velocities (*i.e.*, \dot{z}_b , \dot{z}_w), displacements (*i.e.*, z_b and z_w) are chosen as input variables, the actuator forces (*i.e.*, f_a) is output variables. The original MFs of the inputs and outputs are provided in Fig. 15. Here, N means negative, Z means zero, P means positive. These typical MFs are used to build the interval fuzzy MFs by the method in section 2. With the assumption that the amplitude of uncertainty will not extend the one fifth of original variable, the original values of α and β are 0.2. Considering the balance between the convergence speed and stability of adaptive algorithm, the tuning factors (*i.e.*, η_I and η_O) are both 0.9. For simplicity, the MFs of outputs are chosen as typical MFs which are shown in Fig. 16. Here,

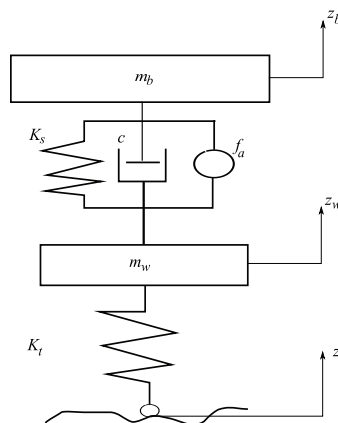

Fig. 14. The quarter vehicle active suspension system

$m_b(Kg)$	$m_w(Kg)$	$k_{s0} (N)$	$k_{s1} (N/m)$
1494.4	120.04	-136	70502
$k_{s2} (Ns/m)$	$k_{s3} (N/m^3)$	$c_1 (Ns/m)$	$c_2 (Ns/m)$
-10865	104	1290	426

Table 3. The Parameters of Quarter Vehicle Active Suspension

NB means negative big, NS means negative small, PS means positive small, PB means positive big. Since the main task is to improve the ride comfort by reducing the body acceleration, the reference variable y^* is defined as the body acceleration, the value is equal to zero. The vehicle speed is 20 m/s.

For evaluation propose, a passive suspension system and a typical FLC are also designed to compare with the proposed approach. The MFs for typical FLC are the original MFs in Fig. 15-Fig. 16.

According to the International Standardization Organization (ISO) classification using the Power Spectral Density (PSD), the class average and poor road surfaces are used as random road inputs, where their road roughness are $6.4 \times 10^{-5} m^3/cycle$ and $2.56 \times 10^{-4} m^3/cycle$, respectively.

Here, two kinds of performance criteria are used to evaluate the vehicle suspension system. One is the root mean square (RMS) value which presents the vehicle ride comfort and handling performance from time domain(Hrovat, 1997). Another is the ride index of body vibration which focus on the ride comfort from frequency weighted vibrating accelerations(2631-1, 1997).

Average Road	VA(m/s^2)	TD (m)
Passive	4.5211×10^{-4}	1.2010×10^{-6}
FLC	4.1460×10^{-4}	2.1465×10^{-7}
Proposed method	4.0032×10^{-4}	1.8423×10^{-7}
Poor Road	VA(m/s^2)	TD (m)
Passive	2.4216×10^{-3}	3.1087×10^{-5}
FLC	1.5671×10^{-3}	1.6233×10^{-6}
Proposed method	1.3211×10^{-3}	1.4213×10^{-6}

^aVA: Vehicle Accelerations, TD: Tyre Deflections

Table 4. The RMS Values Comparison of Body Accelerations with nominal mass m_b

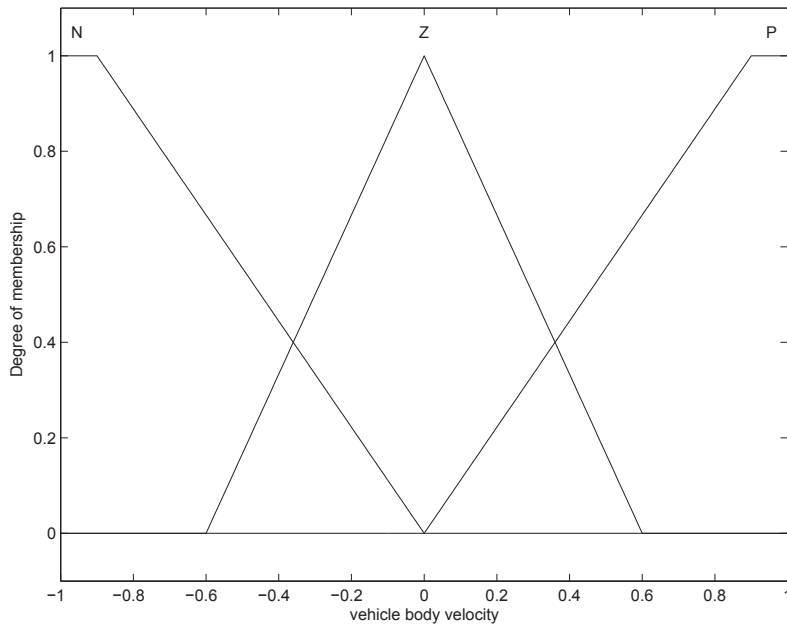

(a) Membership functions of the vehicle body velocities, \dot{z}_b

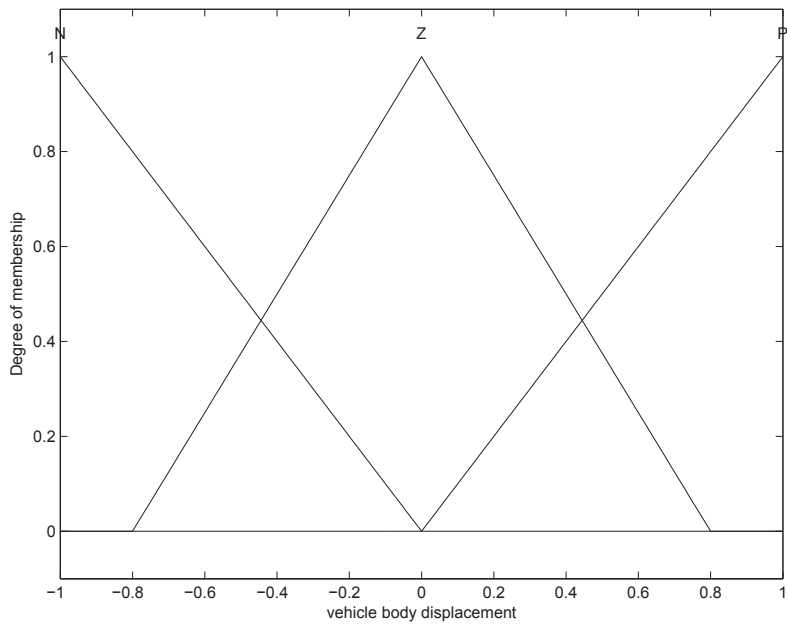

(b) MFs of displacements of the vehicle body, z_b

Fig. 15. Fuzzy membership functions of the input variables

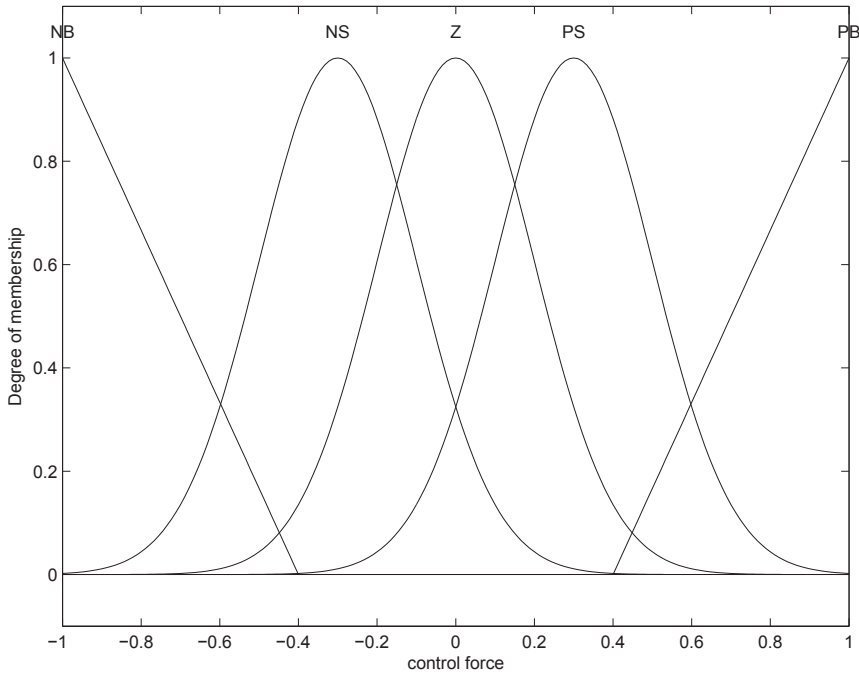

Fig. 16. Membership functions of control forces, f_a

The comparison of RMS values with nominal vehicle body mass m_b are shown in Table 4. With additional $\pm 20\%$ changes of vehicle body mass, the RMS value comparisons are shown in Table 5 and Tabel 6.

Regarding to the RMS accelerations of the vehicle body , the proposed method has achieved better performance on ride comfort than the other two methods. Furthermore, with the comparison of tyre deflections, vehicle handling performance has been improved by proposed method.

6. Concluding remarks

A novel extended fuzzy logic system has been built in this paper. With the interval fuzzy reasoning and adaptive tuning rules, the proposed structure generated a more general framework to cover the uncertain information of complex dynamic systems. Based on this framework, integrating with the DE algorithm, an adaptive fuzzy control system was designed to improve the control performance by using the further optimization process. The EFLS was implemented to solve the inverse kinematic modelling problem of a two-joint robotic arm which can not be well modelled by the typical fuzzy methods. The simulation results verified the EFLS can not only obtain more precise model, but also has potential capability to handle the high level uncertain information due to the understanding of linguistic knowledge and the quantification of fuzzy rules. Furthermore, an adaptive fuzzy control system was designed for a typical complex non-linear system: quarter-vehicle active suspension system. The control performance was improved and the design process was more flexible than other existed methods.

Average Road	VA(m/s^2)	TD (m)
Passive	4.7160×10^{-4}	1.4145×10^{-6}
FLC	4.2312×10^{-4}	2.3254×10^{-7}
Proposed method	4.012×10^{-4}	1.9744×10^{-7}
Poor Road	VA(m/s^2)	TD (m)
Passive	2.5764×10^{-3}	3.7677×10^{-5}
FLC	1.6070×10^{-3}	2.0001×10^{-6}
Proposed method	1.4912×10^{-3}	1.8231×10^{-6}

Table 5. The RMS Values Comparison of Body Accelerations with (1+20%) m_b

Average Road	VA(m/s^2)	TD (m)
Passive	4.3762×10^{-4}	6.8341×10^{-7}
FLC	4.1579×10^{-4}	2.0502×10^{-7}
Proposed method	3.6352×10^{-4}	1.2133×10^{-7}
Poor Road	VA(m/s^2)	TD (m)
Passive	2.1945×10^{-3}	3.0046×10^{-5}
FLC	1.5071×10^{-3}	1.4907×10^{-6}
Proposed method	1.2958×10^{-3}	1.2877×10^{-6}

Table 6. The RMS Values Comparison of Body Accelerations with (1-20%) m_b

Future work has been targeted to address the theory analysis of proposed framework, especially the convergence of adaptive algorithm and impact assessment of uncertainty. Besides, the stability of closed-loop control system should be analyzed.

7. References

- 2631-1, I. (1997). Mechanical vibrations and shock - evaluation of human exposure to whole-body vibration part 1: general requirements, *International Standardization Organization*.
- Abbass, H. (2002). The self-adaptive pareto differential evolution algorithm, *Congress on Evolutionary Computation (CEC2002)*, Vol. 1, Citeseer, pp. 831–836.
- Astudillo, L., Castillo, O. & Aguilar, L. (2007). Intelligent Control for a Perturbed Autonomous Wheeled Mobile Robot: a Type-2 Fuzzy Logic Approach, *Journal of Nonlinear Studies* 14(3): 37–48.
- Baranyi, P., Koczy, L. & Gedeon, T. (2004). A generalized concept for fuzzy rule interpolation, *Fuzzy Systems, IEEE Transactions on* 12(6): 820–837.
- Brest, J., Greiner, S., Boskovic, B., Mernik, M. & Zumer, V. (2006). Self-adapting control parameters in differential evolution: A comparative study on numerical benchmark problems, *IEEE Transactions on Evolutionary Computation* 10(6): 646–657.
- Cao, J., Li, P. & Liu, H. (2009). An extended fuzzy logic system for uncertainty modelling, *FUZZ-IEEE 2009, Korea*, pp. 888–893.
- Cao, J., Liu, H., Li, P. & Brown, D. (2008). Adaptive fuzzy logic controller for vehicle active suspensions with interval type-2 fuzzy membership functions, *FUZZ-IEEE 2008, Hong Kong*, pp. 83–89.
- Castro, J., Castillo, O. & Melin, P. (2008). Intelligent control using an interval type-2 fuzzy neural network with a hybrid learning algorithm, *FUZZ-IEEE 2008, Hong Kong*, pp. 893–900.
- Gan, J., Oyama, E., Rosales, E. & Hu, H. (2005). A complete analytical solution to the inverse kinematics of the Pioneer 2 robotic arm, *Robotica* 23(01): 123–129.
- Hagras, H. (2004). A hierarchical type-2 fuzzy logic control architecture for autonomous mobile robots, *Fuzzy Systems, IEEE Transactions on* 12(4): 524–539.
- Hagras, H. (2008). Developing a type-2 flc through embedded type-1 flcs, *FUZZ-IEEE 2008, Hong Kong*, pp. 148–155.
- Hrovat, D. (1997). Survey of advanced suspension developments and related optimal control applications, *Automatica* 33(10): 1781–1817.
- Huang, Z. & Shen, Q. (2006). Fuzzy interpolative reasoning via scale and move transformations, *Fuzzy Systems, IEEE Transactions on* 14(2): 340.
- Julio, R. & Alberto, V. (2007). Calculating functions of interval type-2 fuzzy numbers for fault current analysis, *IEEE Transactions on Fuzzy Systems* 15(1): 31–40.
- Karaboga, D., Okdem, S. & Simple, A. (2004). A Simple and Global Optimization Algorithm for Engineering Problems: Differential Evolution Algorithm, *Turk J Elec Engin* 12(1).
- Karnik, N. & Liang, J. (1999). Type-2 fuzzy logic systems, *Fuzzy Systems, IEEE Transactions on* 7(6): 643–658.
- Karnik, N. & Mendel, J. (2001). Centroid of a type-2 fuzzy set, *Information Sciences* 132(1-4): 195–220.
- Klir, G. & Folger, T. (1987). *Fuzzy sets, uncertainty, and information*, Prentice-Hall, Inc. Upper Saddle River, NJ, USA.
- Lee, L. & Chen, S. (2008). Fuzzy interpolative reasoning for sparse fuzzy rule-based

- systems based on the ranking values of fuzzy sets, *Expert Systems With Applications* 35(3): 850–864.
- Liang, Q. & Mendel, J. (2000a). Interval type-2 fuzzy logic systems: theory and design, *Fuzzy Systems, IEEE Transactions on* 8(5): 535–550.
- Liang, Q. & Mendel, J. (2000b). Interval type-2 fuzzy logic systems: theory and design, *Fuzzy Systems, IEEE Transactions on* 8(5): 535–550.
- Liu, Z. & Li, H. (2005a). A probabilistic fuzzy logic system for modeling and control, *Fuzzy Systems, IEEE Transactions on* 13(6): 848–859.
- Liu, Z. & Li, H. (2005b). A probabilistic fuzzy logic system for uncertainty modeling, *Systems, Man and Cybernetics, 2005 IEEE International Conference on*, Vol. 4.
- Mendel, J. (2007). New results about the centroid of an interval type-2 fuzzy set, including the centroid of a fuzzy granule, *Information Sciences* 117: 360–377.
- Mendel, J. & John, R. (2002). Type-2 fuzzy sets made simple, *Fuzzy Systems, IEEE Transactions on* 10(2): 117–127.
- Nie, M. & Tan, W. (2008). Towards an efficient type-reduction method for interval type-2 fuzzy logic systems, *FUZZ-IEEE 2008*, Hong Kong, pp. 1425–1432.
- Price, K., Storn, R. & Lampinen, J. (2005). *Differential evolution*, Springer.
- Ross, T. (2004). *Fuzzy logic with engineering applications*, Wiley.
- Sepúlveda, R., Castillo, O., Melin, P., Rodríguez-Díaz, A. & Montiel, O. (2007). Experimental Study of Intelligent Controllers Under Uncertainty Using Type-1 and Type-2 Fuzzy Logic, *Information Sciences* 177(10): 2023–2048.
- Storn, R. (1999). System design by constraint adaptation and differential evolution, *IEEE Transactions on Evolutionary Computation* 3(1): 22–34.
- Storn, R. & Price, K. (1997). Differential Evolution - a Simple and Efficient Heuristic for Global Optimization over Continuous Spaces, *Journal of Global Optimization* 11(1): 341–359.
- Taghirad, H. & Esmailzadeh, E. (1998). Automobile passenger comfort assured through LQG/LQR active suspension, *Journal of Vibration and Control* 4(5): 603–618.
- Wu, D. & Mendel, J. (2009). A comparative study of ranking methods, similarity measures and uncertainty measures for interval type-2 fuzzy sets, *Information Sciences* 179(8): 1169–1192.
- Wu, H. & Mendel, J. (2002). Uncertainty bounds and their use in the design of interval type-2 fuzzy logic systems, *Fuzzy Systems, IEEE Transactions on* 10(5): 622–639.
- Zadeh, L. (1965). Fuzzy sets, *Information and Control* 8(3): 338–353.

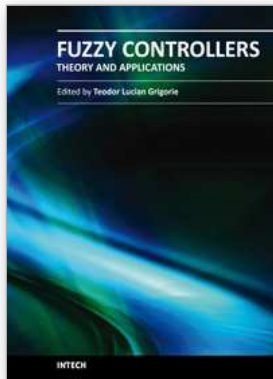

Fuzzy Controllers, Theory and Applications

Edited by Dr. Lucian Grigorie

ISBN 978-953-307-543-3

Hard cover, 368 pages

Publisher InTech

Published online 28, February, 2011

Published in print edition February, 2011

Trying to meet the requirements in the field, present book treats different fuzzy control architectures both in terms of the theoretical design and in terms of comparative validation studies in various applications, numerically simulated or experimentally developed. Through the subject matter and through the inter and multidisciplinary content, this book is addressed mainly to the researchers, doctoral students and students interested in developing new applications of intelligent control, but also to the people who want to become familiar with the control concepts based on fuzzy techniques. Bibliographic resources used to perform the work includes books and articles of present interest in the field, published in prestigious journals and publishing houses, and websites dedicated to various applications of fuzzy control. Its structure and the presented studies include the book in the category of those who make a direct connection between theoretical developments and practical applications, thereby constituting a real support for the specialists in artificial intelligence, modelling and control fields.

How to reference

In order to correctly reference this scholarly work, feel free to copy and paste the following:

Jiangtao Cao, Ping Li and Honghai Liu (2011). Adaptive Fuzzy Modelling and Control for Non-Linear Systems Using Interval Reasoning and Differential Evolution, Fuzzy Controllers, Theory and Applications, Dr. Lucian Grigorie (Ed.), ISBN: 978-953-307-543-3, InTech, Available from: <http://www.intechopen.com/books/fuzzy-controllers-theory-and-applications/adaptive-fuzzy-modelling-and-control-for-non-linear-systems-using-interval-reasoning-and-differentia>

INTECH
open science | open minds

InTech Europe

University Campus STeP Ri
Slavka Krautzeka 83/A
51000 Rijeka, Croatia
Phone: +385 (51) 770 447
Fax: +385 (51) 686 166
www.intechopen.com

InTech China

Unit 405, Office Block, Hotel Equatorial Shanghai
No.65, Yan An Road (West), Shanghai, 200040, China
中国上海市延安西路65号上海国际贵都大饭店办公楼405单元
Phone: +86-21-62489820
Fax: +86-21-62489821

© 2011 The Author(s). Licensee IntechOpen. This chapter is distributed under the terms of the [Creative Commons Attribution-NonCommercial-ShareAlike-3.0 License](#), which permits use, distribution and reproduction for non-commercial purposes, provided the original is properly cited and derivative works building on this content are distributed under the same license.