

Lubrication of Attitude Control Systems

Sathyam Krishnan¹, Sang-Heon Lee¹
Hung-Yao Hsu¹ and Gopinath Konchady²

¹*University of South Australia,*

²*Indian Institute of Technology Chennai,
Australia*

1. Introduction

The spacecraft attitude control system contains attitude error sensors such as gyroscopes and actuators such as momentum wheels and reaction wheels. The control moment gyros (CMG), in which the momentum wheels are mounted in gimbals, are also used in attitude control of spacecrafts. All these systems are designed to operate continuously till the end of the mission at varying speeds of several thousand rpm. The on-orbit performance of spacecrafts depends largely on the performance of the momentum/reaction wheels which in turn depends on the bearings used and its lubrication, since the only component which undergoes wear in these systems are the ball bearings. Currently, the life cycle of spacecrafts are aimed to be around 20–30 years. However, the increases in size, complexity and life expectancy of spacecrafts demand advanced technologies especially in tribology and in turn the development of more innovative lubrication systems for long-term operation.

Space tribology is a subset of the lubrication field dealing with the reliable performance of satellites and spacecraft including the space station. Lubrication of space system is still a challenging task confronting the tribologists due to the unique factors encountered in space such as near zero gravity, hard vacuum, weight restriction and unattended operation. Since the beginning of space exploration, a number of mission failures have been reported due to bearing system malfunction (Robertson & Stoneking 2003; Kingsbury, et.al., 1999; Bedingfield, et. al., 1996) and the most recent is the bearing failure in the control moment gyro (CMG) of the international space station on July 2002 (Burt and Loffi, 2003).

1.1 Momentum/reaction wheels

Momentum/reaction wheels are spacecraft actuators used for control and stabilization of spacecraft attitude to the required level. These are momentum exchange devices that works by the principle of conservation of angular momentum. The torque produced by changing angular momentum of the wheel is used to turn the satellite to the required direction. Since the inertia of the satellite is large compared to the inertia of the wheels, a very precise control of the satellite orientation is possible with these systems. A typical momentum/reaction wheel contains a flywheel which is driven by an electric motor, generally, a brushless dc motor as shown in Fig. 1 (Sathyam, 2010). Its precise rotation about a fixed axis is ensured by mounting it over a bearing unit consisting of a pair of high precision angular contact ball bearings. The flywheel and the rotor of the motor are

mounted on the bearing unit housing. The speed of the flywheel is controlled through a drive electronics circuit. All these components are enclosed in a hermetically sealed metal casing purged with an inert gas. Usually the internal pressure is less than atmospheric, typically 15 torr. There are different designs of flywheels such as single piece machined disc type wheels and built-up spoked type wheels. For larger angular momentum, spoked type flywheels are generally used since it has the advantage of low mass to inertia ratio compared to disc type flywheels. Also, built-up flywheels shows better vibration damping properties, which is highly important in spacecraft systems. The normal operating speeds of momentum wheels are in the range of 3000 to 10000 rpm and produces angular momentum 50 to 200 Nms (Briscoe & Aglietti, 2003; Sathyan, 2003). The reaction wheels are usually small in size compared to the momentum wheels and has bidirectional capability. The speed range is about 3500 rpm and angular momentum capacity upto 5 Nms.

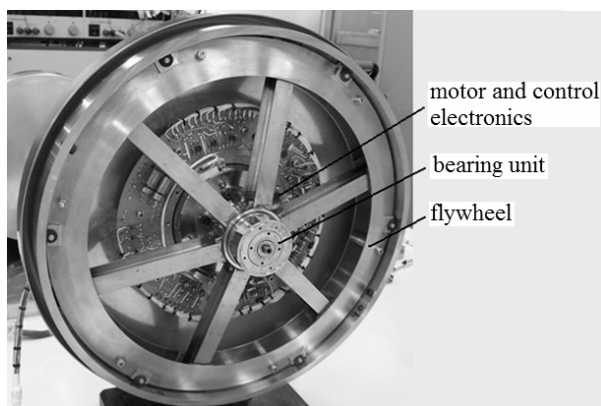

Fig. 1. Momentum wheel with top cover removed

1.2 Bearing unit

The bearing unit is the most critical subassembly of a momentum wheel. The life and performance quality of a momentum/reaction wheels to a great extent depends on the bearing unit. Unlike the electronic circuits, it is not possible to design a momentum wheel with redundant bearing units, therefore utmost care is given in the design, manufacturing and processing of bearing units. Fig. 2 shows a typical bearing unit used in a momentum wheel (Sathyan et.al., 2008). The bearing unit is generally made of high quality steel to ensure high strength and dimensional stability. AISI 440C is the most commonly used material for bearing units. Usually the bearings and the bearing unit components are made of the similar material to eliminate the effects of thermal stresses, because in service the wheels are subjected to wide ranges of temperatures. The bearings typically used in a momentum wheel are of light series high precision angular contact ball bearings (ABEC 9). The size of the bearings are determined based on the angular momentum required, typically for a 60 Nms wheel operating in a speed range 3000–6000 rpm, 20 mm bore is common (104 size). The bearings are usually arranged in back to back configuration and are separated by a set of equal length spacers.

There are two different designs of bearing units available such as rotating shaft design and rotating housing design. In rotating shaft design, the bearing housing is rigidly mounted on

the base plate of the wheel and the flywheel and the motor rotor are mounted on the shaft (Honeywell, 2003). In the rotating housing type, the bearing unit shaft is mounted on the base plate and the flywheel and motor rotor are mounted on the bearing housing (Auer, 1990; Jones and Jansen, 2005; Sathyan, 2003). Fig. 2 shows a typical rotating housing bearing unit used in a momentum wheel.

In bearing units, ball bearings with non-metallic retainers [cages] are generally used. However, retainerless bearings are also used in momentum wheel bearing units considering its advantages such as high loadability and absence of retainer instability. Retainer instability is one of the major causes of failure in high speed spacecraft bearings (Shogrin, et.al., 1999; Kannel and Snediker, 1977). Bearing retainers commonly used in momentum/reaction wheels are made from cotton based phenolic materials. The retainers made from this material can absorb certain amount of oil in its body and can act as a primary source of lubricant. Phenolic retainers are carefully and thoroughly dried to remove any absorbed moisture before they are impregnated with oil. Otherwise, the retainer will not be fully saturated and may absorb and remove oil from the bearing it is intended to lubricate (Bertrand, 1993). The lubricant stored in the retainer is sufficient to run a wheel continuously for 3-4 years with stable performance. A supplementary lubrication system is included either inside the bearing unit or inside the wheel casing to augment the life of the wheel to the required number of years.

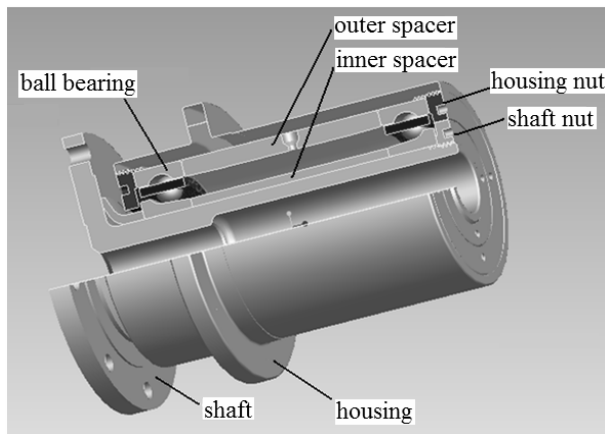

Fig. 2. Bearing unit assembly

Being a critical part, the bearing assembly needs exceptional care. The bearings in a momentum/reaction wheels are generally lubricated with specially developed liquid lubricants. A wide variety of lubricants are developed and used by different manufacturers. These lubricants possess certain important properties that are essential for successful operation in space environments.

A bearing in a momentum/reaction wheel may fail due to multiple reasons such as chemical degradation of lubricant, loss of lubricant from the working zone by surface migration and evaporation, and retainer instability. Retainer instability is the most dangerous mode of failure in spacecraft bearings. The retainer instability is related to a number of factors like geometry and mass of the retainer, operating speed, lubricant quantity, etc. The retainer instability problem can be totally eliminated by using retainerless bearings. Thus, with the

selection of proper lubricant and proven retainer design, lubrication becomes the principle life limiting problem on momentum wheels.

Generally, momentum/reaction wheels are made with high precision angular contact ball bearings having non-metallic retainers. These retainers act as a primary source of lubricant when it is impregnated with the lubricant. With this initial lubrication, the bearings can perform up to 3–4 years normally, provided the retainer is running stable. However, the current life requirement for momentum wheels and other high speed space systems are more than 20 years or even up to 30 years. This implies the need for efficient supplementary lubrication systems to achieve the mission life. Moreover, it is not possible to service the spacecrafts once it is launched. Therefore, in-situ, remote lubrication systems are employed in momentum/reaction wheels.

According to the nature of operation, the lubrication systems used in momentum wheels can be broadly classified as passive lubrication systems and active lubrication systems. The passive systems also known as continuous systems, supplies lubricant continuously to the bearings and is driven by centrifugal force or by surface migration force. The active lubrication systems, also known as positive lubrication systems, supplies a controlled amount of lubricant to the bearings when it is actuated by external commands

2. Tribology of attitude control systems

The word “tribology” was first introduced in the publication named “Department of Education and Science Report” England in 1966, and is defined as the science and technology of interacting surfaces in relative motion and of the practices related thereto (Hamrock, et.al., 1994). In otherwords, it is the study of friction, wear and tear, and lubrication of interacting surfaces.

At the beginning of the space explorations in 1957 when the first satellite was launched, scientists were unaware of the term tribology as a multidisciplinary subject. This is because, the spacecrafts never faced any lubrication problems for the short duration exploration. However, as the life requirement changed, especially with the development of communication satellites, spacecraft designers realised the importance of tribology in space system design. As a result, space tribology is emerged as a subset of the lubrication field dealing with the reliable performance of satellites and spacecraft including the space station. Lubrication of space system is still a challenging task before the tribologists due to the unique factors encountered in space such as near zero gravity, hard vacuum, weight restriction and unattended operation (Fusaro, 1992). Kannel and Dufrane (Kannel and Dufrane, 1986) conducted a study of tribological problems of past space systems and predicted the future tribological challenges. According to them “The development of aerospace mechanisms has required considerable advances in the science of friction, wear, and lubrication (tribology). Despite significant advances in tribology, the insatiable demands of aerospace systems seem to grow faster than the solutions.” A qualitative chart based on their study is shown in Fig. 3. This is a valid chart for the present and can be extended many more years because still there are space system failures due to tribological problems.

The main purpose of lubrication is to reduce the friction between the interacting surfaces in relative motion by introducing a third body (called lubricant) between them. The third body should have very low shear strength so that the mating surfaces do not undergo wear or damage. There are different lubricant materials available in various forms such as liquids,

gases and solids. Attitude control systems are generally lubricated with liquid lubricants. Depending upon the thickness of lubricant film present between the interacting surfaces, four well defined lubrication regimes are identified such as hydrodynamic, elastohydrodynamic (EHD), mixed and boundary lubrication regimes (Zaretsky,1990; Jones and Jansen, 2000; Dowson, 1995; Fusaro, 2001). These four regimes are clearly understood from the Stribeck/ Hersey curve (Fig. 4), which shows the coefficient of friction as a function of dimensionless bearing parameter (ZN/P), where, Z is the lubricant viscosity, N is the velocity at the contact surface and P is the bearing load. A space bearing with liquid lubrication undergoes the last three regimes namely EHD, mixed and boundary before it fails due to lubricant starvation. Since it is not preferred to run the bearings in the hydrodynamic region due to the high viscous drag resultant from the high lubricant film thickness as seen from Fig. 4.

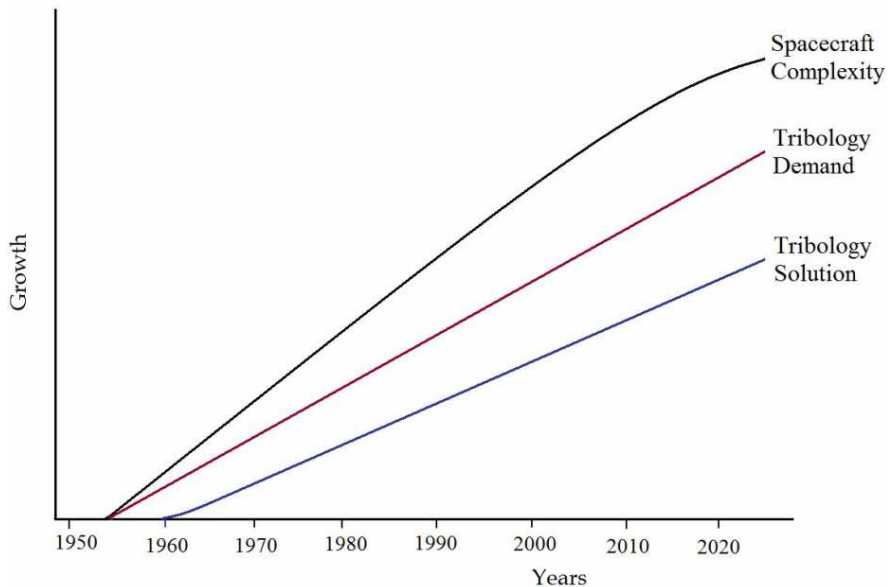

Fig. 3. Growth of spacecraft technology and tribology challenges

The concentrated research on elastohydrodynamic lubrication (EHD) resulted in the identification of three subdivisions in EHD, namely starved EHD, parched EHD and transient/non-steady state EHD (Jones and Jansen, 2005). In starved EHD lubrication, the pressure build-up at the inlet contact region is low due to restricted oil supply. As a result the lubricant film will be thinner than calculated by EHD theory (Hamrock and Dowson, 1981). In parched EHD lubrication, the lubricant films are so thin that they are immobile outside the contact zone (Kingsbury, 1985; Guangteng, et.al. 1992) and this regime is particularly important for momentum/reaction wheel bearings. In the transient/non-steady state EHD lubrication, the load, speed and contact geometry are not constant with time. The theoretical behavior of this regime in point contact bearings is not well understood (Jones and Jansen, 2005) but it was studied experimentally by Sugimura et al. (Sugimura, et.al, 1998). Generally, the momentum/reaction wheel bearings are designed to be operated in the lower boundary of EHD region because it has the advantage of the lowest coefficient of friction.

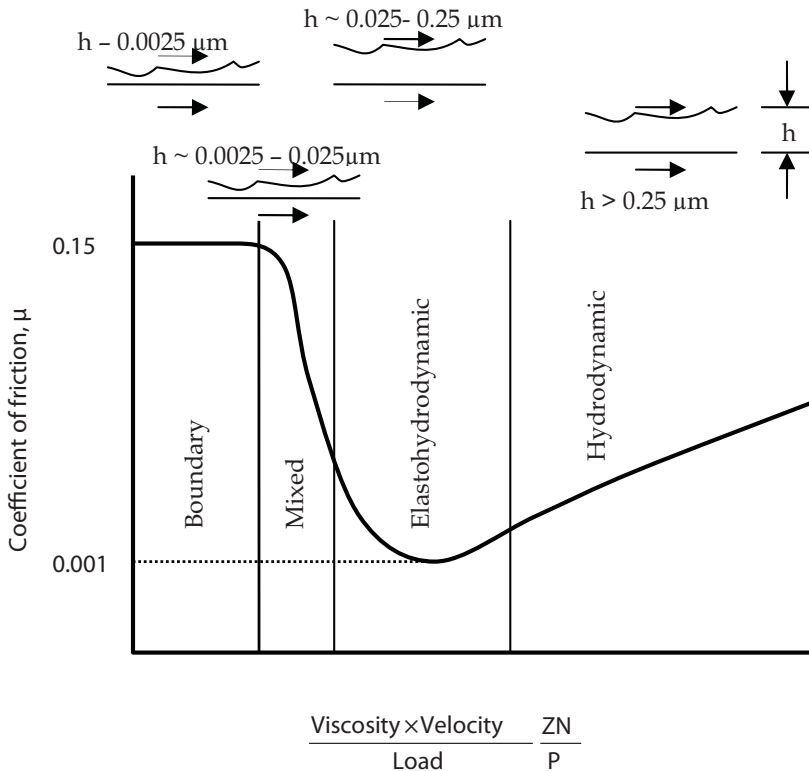

Fig. 4. Stribeck/Hersey curve (Fusaro, 2001)

In EHD lubrication, the load is carried by the elastic deformation of the bearing material together with the hydrodynamic action of the lubricant (Dowson, 1995; Hamrock and Dowson, 1981). A bearing operating in EHD region shows an indefinite life with lowest friction torque. The most interesting practical aspect of the EHD lubrication theory is the determination of lubricant film thickness which separates the ball and the races. The generally used equation for calculating the film thickness is the one developed by Hamrock and Dowson (Hamrock & Dowson, 1981):

$$H_{min} = 3.63 U_s^{0.68} G^{0.49} W^{-0.073} (1 - e^{-0.68k}) \tag{1}$$

and

$$H_{min} = \frac{h_{min}}{R_x} \tag{2}$$

where H_{min} is dimensionless minimum EHD film thickness, U_s is the dimensionless speed parameter, G is the dimensionless material parameter, W is the dimensionless load parameter, h_{min} is the minimum film thickness and R_x is the effective radius. The effectiveness of EHD lubrication is described by the λ ratio or film parameter, which is the

ratio of central film thickness at the Hertzian contact zone to the r.m.s. surface finish of the rolling element surface:

$$\lambda = \frac{h_{\min}}{\sqrt{(S_r^2 - S_b^2)}} \quad (3)$$

where S_r and S_b are the r.m.s surface finish of races and balls. The EHD regime is characterized by λ ratio between 3 and 10, which corresponds to a film thickness between 0.1 and 1 μm . It has been pointed out that a full film can be obtained with no asperity contact only when $\lambda > 3$. If the value of $\lambda < 3$, it will lead to mixed lubrication with some asperity contacts (Hamrock and Dowson, 1981). The calculated film thickness and λ ratio for a typical momentum wheel bearing (20 mm bore, 6.35 mm ball, ABEC 9P class) operating at 5400 rpm with a lubricant having pressure-viscosity coefficient $2 \times 10^{-8} \text{ m}^2/\text{N}$ and a bearing preload 50 N is 0.62 mm and 13.4 for the inner race contact and 0.76 mm and 16.3 for the outer race contact, respectively (Sathyan, 2003). Experimental verification of film thickness has been done by Coy et.al. on 20 mm bore ball bearing using the capacitance technique and the reported values ranging from 0.025 to 0.51 mm (Coy, et.al. 1979).

Tribological failures of momentum/reaction wheels are related to lubricant breakdown, loss of lubricant due to evaporation and surface migration (insufficient lubricant) and retainer instability. Lubricant breakdown failure occurs when the original liquid lubricant is chemically changed to solid friction polymer (Kingsbury, et.al., 1999). Kingsbury (Kingsbury, 1992) has shown that the rate of lubricant polymerization is determined by the thickness of the EHD film, larger rate for thinner films and negligible for thicker films. Loss of lubricant in momentum wheels occurs mainly due to evaporation, surface migration and centrifugal action. The working temperature, which is also a function of bearing friction torque, causes the lubricant to evaporate. The oil loss by migration is induced by temperature gradients and capillary forces. It was demonstrated that a small temperature gradient leads to the rapid and complete migration of thin oil films to the colder regions (Fote, et.al., 1978). The capillary migration describes the tendency of oil to flow along surface scratches and corners and is driven by pressure gradient in the radius of curvature of the oil-vapor interface.

Retainer instability is the most dangerous mode of failure in momentum wheel bearings. It has been the topic of interest for many researchers and tribologists and lot of published data are available (Taniwaki, et.al., 2007; Gupta, 1991; Kannel and Snediker, 1977; Boesiger, et.al., 1992). Generally, retainer instability is characterized by large variation in bearing friction torque associated with severe audible noise. There are three types of instabilities (Stevens, 1980) such as radial instability, axial instability and instability due to change in running position of retainer. The radial instability is characterized by high frequency radial vibration of the retainer and result in abrupt torque variation. Under marginal lubrication condition, this will cause significant torque increase and audible noise, whereas under excess lubrication it will show a sudden reduction in torque. The axial instability is characterized by high frequency axial vibration of the retainer and is mainly due to excessive clearance between the rolling element and the retainer pocket. The position instability occurs when the retainer oscillates between its mean position of running and the races. When it runs in the mean position, the friction will be nominal and occasionally the retainer moves in the radial

direction and run in that position rubbing against the race. This will result in a periodic change in friction torque as shown in Fig. 5. Uneven cage wear, lubricant degradation and insufficient lubrication are the prime causes for instabilities. It is also related to a number of factors like geometry and mass of the retainer, operating speed, lubricant quantity, etc. (Lowenthal, et.al., 1991; Boesiger and Warner, 1991; Gupta, 1988 and 1991). The retainer instability problem in attitude control wheels can be eliminated by using retainerless bearings (Shogrin, et.al., 1999; Kingsbury, et.al., 1999). Momentum/reaction wheels with retainerless ball bearings are now available (Kingsbury, et.al., 1999; Boesiger and Warner, 1991; Jones, et.al., 1997; Singer and Gelotte, 1994), which overcomes the most devastating problem observed in conventional bearings. Thus, with the selection of proper lubricant and proven retainer design, lubrication remains the principle life limiting problem on attitude control wheels.

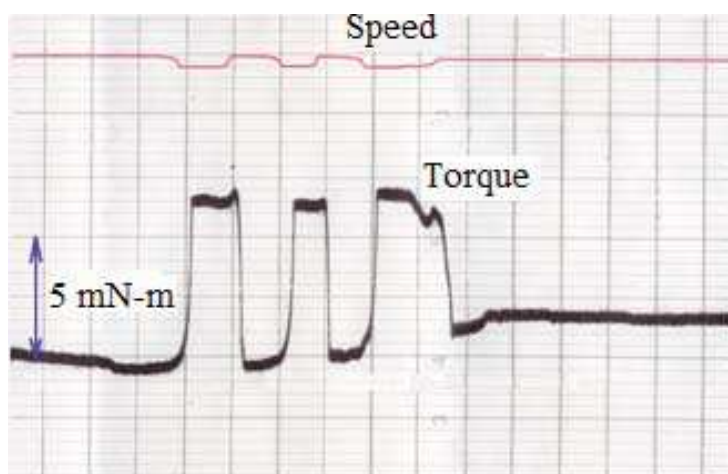

Fig. 5. Bearing friction torque variation due to retainer position change

Since the bearings are still mechanically intact when the lubricant degrades, if lubricant could be resupplied to the contact, the life of the wheels could be extended. Kingsbury (Kingsbury, 1973) has shown that only $0.2 \mu\text{g/h}$ lubricant flow rate is needed to maintain a continuous EHD film in instrument ball bearings. This is a very low value and is difficult to achieve practically, but efforts are underway to develop lubricant supply systems with the lowest possible flowrate, possibly less than $10 \mu\text{g/h}$ (Sathyan, et.al, 2010).

3. Qualities required for space lubricants

Momentum / reaction wheels are generally lubricated with liquid lubricants because of its outstanding merits over solid lubricants such as excellent torque characteristics and means of replenishment. The primary advantage obtained with liquid lubricants is that bearing surfaces separated by hydrodynamic films of liquid lubricants have virtually no wear and thereby have the potential for infinite lives. Since no single lubricant can meet the often conflicting requirements of various applications for liquids, hundreds of specialty lubricants have been developed for aerospace applications.

There are a number of factors to be considered while selecting a lubricant for attitude control wheels. Since these wheels are designed to operate in the elastohydrodynamic lubrication region, the EHL properties of the lubricant are of prime importance. Typically, a momentum wheel lubricant should have the following essential properties:

Viscosity Index: Since the attitude control wheel has to work over a wide temperature range (typically between 15 and 85°C) the change in viscosity with temperature should be minimum to maintain the EHD film. Therefore a lubricant with high viscosity index needs to be selected.

Vapor Pressure: The volatilization of lubricant contaminates the spacecraft systems and may have harmful effects; therefore the vapor pressure should be low in order to minimize losses by evaporation and to limit the pollution due to degassing. Fig. 6 shows the relative evaporation rates of various aerospace lubricants.

Pressure-viscosity Coefficient (α): The pressure-viscosity coefficient is important in determining the EHD film thickness at the ball-race contact inlet. From EHL theory, the lubricant with the largest α value should yield the thickest film at room temperature (Jones and Jansen, 2005).

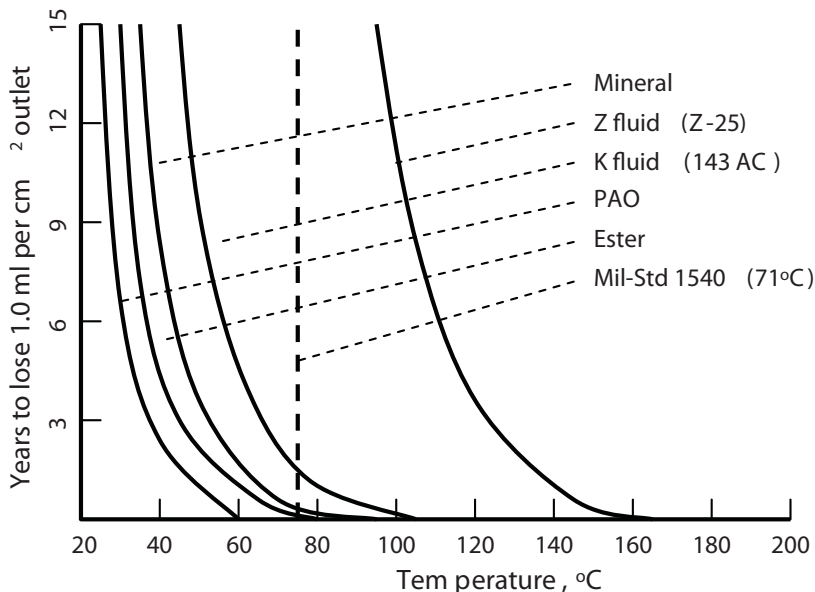

Fig. 6. Evaporation rates of various aerospace liquid lubricants (Jones and Jansen, 2005)

4. Space liquid lubricants

There are a number of liquid lubricants that have been used in attitude control wheel bearing lubrication. Most of these lubricants are formulated and developed specially for space application and some of these are not readily available in the market. These lubricants fall under different classes based on their chemical structure such as mineral oils, silicone fluids, esters, synthetic hydrocarbons, perfluoropolyethers (PFPE) and silahydrocarbons. Table 1 shows the property data of some of these lubricants.

Lubricant Properties		Mineral Oils		Esters		Silicon fluids	Synthetic Hydrocarbons			PFPE	
		KG 80	SRG 60	Klubber PDP 65	BP 135	Versilube-F 50	Nye 186A (POA)	Nye 3001A	permzane® SHFX-2000	Fomblin™ Z-25	Krytox™ 143 AB
Viscosity, $\frac{cP}{cSt}$	@100°C		9.44	15.5		16	14.6	15.75	14.6	49	10.3
	@ 40°C	520 (20°C)	77.6	73	55 (20°C)	52	103	127.5	108	159	85
	Index	101	106	235	128		146	130	137	335	113
Flash Point (°C)			232	230			248		300		
Pour Point (°C)		-9	-12	-60	-45	-73	-48	-48	-55	-66	-43
Sp. Gravity (g/cc)			0.88	0.915		1.045	0.85 (15°C)	0.83 (100°C)	0.85	1.85 (20°C)	1.89
Vapour Pressure (Torr) @100°C		1×10^{-6} (20°C)	10^{-8}	7×10^{-4}	10^{-6}		5×10^{-8}	2.4×10^{-7}	1.4×10^{-10}	1.3×10^{-8}	1.5×10^{-8}
Surface tension (mN/m)			30	30						25	18.5

4.1 Mineral oils

Mineral oils are natural hydrocarbons with a wide range of molecular weights. The paraffinic base oils are commonly used for space applications. Super refined mineral oils were the lubricant of choice for momentum wheels in the early periods, KG80 and Apiezon C are examples (Zaretsky, 1990). The super refined gyroscope [SRG] oils are another class of mineral oils widely used in momentum wheels. These are available in a wide viscosity ranges, for example SRG-40 [27cSt at 40°C] and SRG-60 [77.6 cSt at 40°C] (Kannel and Dufrane, 1986).

4.2 Silicon fluids

Silicon lubricants were used in the early spacecrafts. An example for silicon lubricant is GE Versilube F50, a chloroarylalkylsiloxane [CAS]. This oil has a very low vapor pressure and excellent low temperature properties. However, it degrades quickly under boundary lubrication conditions (Vernier and Casserly, 1991), which limited its application in many space systems. Silicone lubricants have a strong tendency to migrate and may adversely affect conductivity of electrical contacts.

4.3 Esters

Esters are inherently good boundary lubricants and are available in a wide range of viscosities. Diesters and triesters are the commonly used lubricants. The British Petroleum in 1970 developed a triester for space application and the European Space Tribology Laboratory [ESTL] has qualified this oil for high speed space mechanisms (Jones and Jansen, 2000), but its production was stopped and was never used in spacecrafts. A series of esters are marketed by Nye Lubricants; namely, UC4, UC7 and UC9. The ISOFLEX PDP65. A diester oil produced by Kluber Lubrication is a proven momentum wheel lubricant (Sathyan, 2003). This lubricant has very high viscosity index [235] and very low pour point [-60°C].

4.4 Synthetic hydrocarbons

Synthetic hydrocarbons are of two groups, polyalphaolefins (PAO) and multiply alkylated cyclopentanes (MACs). The PAO is typically made by oligomerization of 1-decene, for example Nye 186A, 3001A. A more detailed study of Nye 3001A and 3001(formulated) are presented in Ref. (Dube, et.al, 2003). MACs are synthesized by reacting cyclopentadiene with various alcohols in the presence of a strong base (Vernier and Casserly, 1991). The products are hydrogenated to produce the final products, which is a mixture of di-, tri-, tetra or penta alkylated cyclopentanes. These lubricants are known as Pennzanes® and the two types which currently in use are SHF X1000 and SHF X2000. It has been proved that addition of silver nano particles to MACs base oil will significantly improve its wear properties and load-carrying capacity and slight effect on its friction property (Ma, et.al., 2009).

4.5 Perfluoropolyethers (PFPE)

Perfluoropolyether is clear colorless fluorinated synthetic oil. These are nonreactive, nonflammable and long lasting lubricants. PFPE lubricants have very low outgassing properties compared to any other lubricants (Fowzy, 1998). These lubricants have been in use for over 30 years. This is a well known ball bearing lubricant for the international space

station (Mia, et.al, 2007). PFPE lubricants are made by polymerization of perfluorinated monomers. There are a number of PFPE lubricants available for space applications such as Krytox™, Fomblin™, Demnum™ etc. These are high density lubricants and due to this, yield EHD film thickness twice that of other lubricant having the same kinematic viscosity (Jones, 1993). However, it has been reported that viscosity loss both temporary and permanent occurred under EHL conditions due to high contact pressure (Mia, et.al, 2007). Also, reported that lubricant breakdown (tribo-corrosion) occurs with PFPE lubricants under boundary conditions (Jansen, et.al, 2001).

4.6 Silahydrocarbons

Silahydrocarbons are relatively new class of lubricants with great potential for use in space mechanisms. They are unimolecular species consisting of silicon, carbon and hydrogen and posses unique tribological properties. Silahydrocarbons have very low vapor pressure, high viscosity index and are available in wider viscosity ranges. These are available as tri-, tetra- and penta silahydrocarbons based on the number of silicon atoms present in their molecules. Silahydrocarbons are compatible with conventional lubricant additives. A detailed study of this class of lubricant appears in Ref. (Jones, et.al, 2001).

The EHL effectiveness of different classes of lubricant is shown in Fig. 7. The EHL performances of lubricants are improved by adding chemical additives such as extreme pressure, anti-wear and anticorrosion additives. The extreme pressure (EP) additive reacts with the bearing material to form surface films which prevent metal to metal contacts under high loads. Tricresylphosphate (TCP) is the commonly used EP additive and is usually added as 5% of the lubricant volume. The anti-wear additives are added to reduce the boundary lubrication wear, lead naphthenate (PbNp) is an example of such additives. Most lubricants mentioned above are compatible with these additives except the PFPE. Effective additives are recently developed for PFPE lubricants, but they have not yet found their application into space lubricants. A space lubricant must be thoroughly characterized before being put into real application. Various types of tribometers such as four ball tribometers, spiral orbit tribometers, pin on disk tribometers, etc. are used to evaluate the EHL properties of these lubricants. In addition to this a full scale system level life test is also recommended to evaluate actual performance.

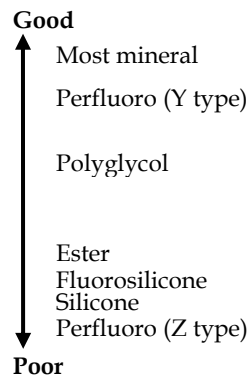

Fig. 7. EHD effectiveness of some oils (Roberts and Todd, 1990)

5. Lubrication systems

As mentioned before, the bearing unit of attitude control wheels are made with high precision angular contact ball bearings having non-metallic retainers. These retainers act as a primary source of lubricant when it is impregnated with the liquid lubricant. For example, a phenolic retainer for 104 size bearing, when properly impregnated and soaked in oil for 60 days, holds approximately 90 mg of oil in its body. This is because the retainer materials are made with phenolic resin reinforced with fine cotton fabric. During impregnation and soaking, the oil penetrates into the cotton layer and is later available for lubrication. Also, the bearing metal surface, after centrifuged to the operating speed (say 5000 rpm), hold approximately 15–20 mg of oil. Altogether, about 100 mg of oil per bearing is available initially. With this initial charge of lubrication, the bearings can perform up to 3–4 years normally, provided the retainer is running stable. However, with a retainerless bearings (full complement bearing), the retainer oil is absent and the bearing surface oil is about 20 mg (the absence of retainer facilitates addition of more balls). The current life requirement for momentum wheels and other high speed space systems are more than 20 years or even up to 30 years. According to Auer (Shapiro, et.al, 1995) “the ball bearing lubrication remains the principal life-limiting problem on momentum and reaction wheels”. This reveals the need for efficient supplementary lubrication systems to achieve the longer mission life. Moreover, it is not possible to service the spacecrafts once it is launched. Therefore, in-situ, remote lubrication systems are employed in attitude control wheels.

According to the nature of operation, the lubrication systems used in momentum/reaction wheels can be broadly classified as active lubrication systems and passive lubrication systems. The active lubrication systems, also known as positive lubrication systems, supplies a controlled amount of lubricant to the bearings when it is actuated by external commands. The positive commandable lubricators, remote in-situ systems, etc. are examples of active systems. The passive systems, also known as continuous systems, supplies lubricant continuously to the bearings and is driven by centrifugal force or by surface migration force. The centrifugal lubricators, the oozing flow lubricators, wick feed systems, porous lubricant reservoirs, etc. come under this classification.

5.1 Active lubrication systems

The active lubrication system supplies lubricant depending on the demand. Different types of active systems are currently in use and some of these systems are briefed here.

Positive Lubrication Systems: In this type of lubrication systems, a known quantity of lubricant is delivered to the bearings when the system is actuated by external commands. The command to actuate the lubricator is executed when a demand for lubricant is arise. The demand is indicated either by an increase in power consumption of the wheel or by increase in bearing temperature resultant of increased bearing friction torque. Different versions of positive lubrication systems are available with different actuators such as solenoid valves, stepper motors, etc.

The commandable oiler developed by Hughes Aircraft Company (Glassow, 1976), in which a solenoid operated piston moves inside a reservoir, one end of which acts as cylinder. A quantity of oil equal to the cylinder volume is discharged during every operation. The oil coming out of the cylinder is directed to the bearings through a 1.5 mm stainless steel tubing. The capacity of the reservoir is 6 g and the quantity delivered per stroke is 45 mg. This system had been used in the Intelsat IV satellites. The positive

lubrication system (PLUS) developed by Smith and Hooper (Smith and Hooper, 1990) is another kind of solenoid operated lubricator. In this system, the oil is stored in a metallic bellows and is pressurized by a compression spring. The high pressure oil is delivered to the bearings by actuating the solenoid valve connected to the reservoir. The amount of oil delivered is 0.2–5 mg for 125 ms opening of the valve. The amount of oil delivered depends on the reservoir pressure, oil temperature and plumbing resistance and the oil viscosity.

The positive-pressure feed system proposed by James (James, 1977) consisted of a spring loaded metallic bellows in which oil is stored under pressure, release valve, metering valve, metering bellows and lubricant feed line. When the release valve is operated, the oil flows out to the line through the metering bellows and the metering valve. The amount of oil delivered is controlled by the metering bellows. The lubricant feed line terminates near the bearing delivers oil to the bearing surface. In this case the lubricant is injected directly into the bearing balls, which transfer it to the contact surfaces. Fig. 8 shows the arrangement.

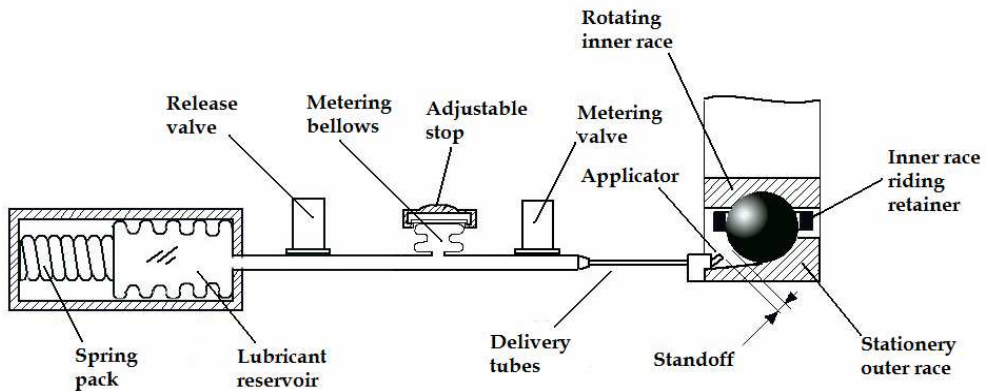

Fig. 8. Positive commandable lubricator for satellite bearing application (James, 1977)

The command lubrication system (CLS) (Sathyan, et.al., 2010) is another active lubrication system contains flexible metallic bellows, a micro stepping motor, frictionless ball screw, injection nozzle and capillary tubes. The stainless steel bellows act as the oil reservoir in which the oil is stored under ambient pressure. The pressure is usually the internal pressure of the momentum/reaction wheel or control moment gyro (CMG), if it is placed inside the system, and is usually varies between 15 torr and 350 torr. The bellows is of compression type having a swept volume of approximately 1.5 cc, i.e. the difference between the normal and fully compressed states. The micro stepping motor, which is the actuator, is a geared motor having a torque capacity of 130 mN-m and is driven through the drive electronics. The motor shaft is connected to the reservoir bellows through the precision ball screw (3 mm size). It is properly lubricated with space proven lubricant and protected from contaminants. One end of the screw is rigidly connected to the motor shaft. The housing/nut of the ball screw is attached to the bellows through the link, which houses the ball screw. The ball screw converts the rotary motion of the motor shaft into liner motion and thus actuates the bellow. On the delivery end of the bellows, a nozzle is attached which connects the capillary tubes with the bellows as shown in Fig. 9.

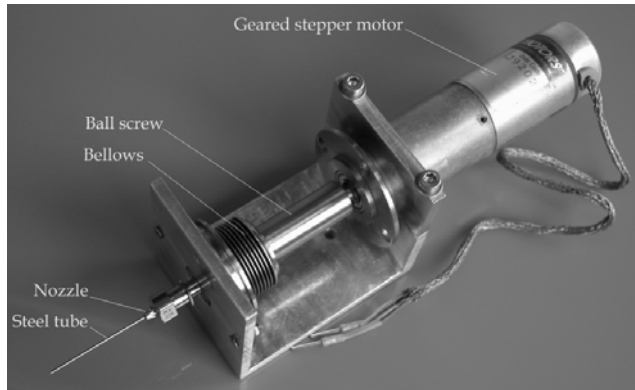

Fig. 9. Command lubrication system

The CLS is operated when a demand for lubricant arises. In spacecraft, the demand is indicated either by an increase in bearing temperature as a result of increased bearing friction torque or increased motor current to maintain the rotational speed. In such situation, the drive motor of the CLS is actuated for a predetermined period of time to deliver oil to the bearings. When the motor shaft rotates, the ball screw attached to it also rotates. The housing/nut of the ball screw which is rigidly mounted on the bellows moves linearly and presses the bellows. As a result, the pressure of oil in the bellows increases and it flows out through the capillary tubes. The delivery tip of the tube is placed adjacent to the rotating bearing. A set-off distance, i.e. the distance between the nozzle tip and the rotating element of the bearing, is provided to prevent the tip from touching the bearing. The set-off is equal to the diameter of the oil droplet. It was experimentally determined that the weight of a drop of oil (Kluber PDP-65 oil) is approximately 8 mg and the size is about 2.5 mm. therefore, the set-off distance in this case is 2 mm. At the delivery tip of the tube, oil forms droplets and when the size of the drop is sufficiently large, it touches the rotating element of the bearing and transfers to the contact surfaces. The nozzle tip can be suitably located near the bearing depending on the design of the bearing unit to ensure oil discharge to bearings.

The amount of oil delivered can be precisely controlled. Fig. 10 shows the amount of oil delivered by CLS when operated for duration of 5 s each. The bellows can hold approximately 2.5 g oil and the quantity delivered per cycle (5 s duration) as shown in figure is approximately 15 mg. Therefore, if two operations per year are planned, the CLS can lubricate the wheel bearings for more than 25 years. Also, in this system, since the oil is stored at ambient pressure, the chances of leaks are absent.

In-situ Lubrication Systems: In these systems, the lubricant is stored in a porous medium placed adjacent to the bearings. When the porous medium is heated up by some means, it ejects the oil stored in its pores due to differential thermal expansion. The in-situ on demand lubricator developed by Marchetti (Marchetti, et.al, 2001, 2001) consists of a porous material cartridge to which an electric heater is attached. The cartridge is impregnated with oil and is attached to the stationary race of the bearing. When the cartridge is heated, due to the higher thermal expansion of the oil compared to the porous material, oil flows out of the cartridge. The oil coming out of the cartridge is migrated to the bearing surfaces due to the low surface tension of oil compared to the bearing metal. It is actuated when the bearing temperature increases due to higher friction, demanding lubricant.

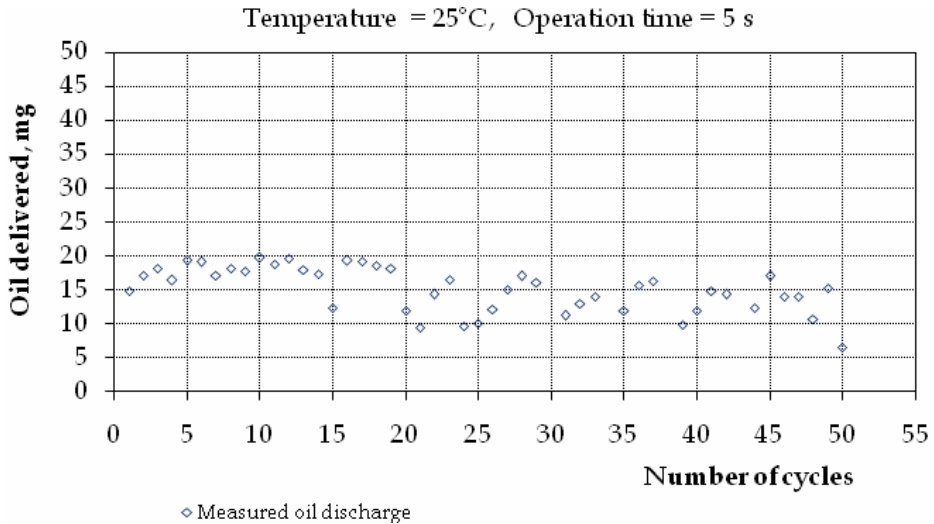

Fig. 10. Oil discharged by CLS for 50 cycles

Another type of in-situ lubrication system is the static lubricant reservoir (Sathyan, 2003), consists of a porous material reservoir of cylindrical shape mounted on an aluminum sleeve. An electric foil heater is pasted inside the aluminium sleeve. The porosity of the reservoir material is about 30% by volume so that it carries sufficient amount of lubricant to support for the entire mission period. The reservoir assembly is mounted on the static part of the bearing unit. When the heater is put on, it heats up the oil inside the reservoir and it flows out due to differential thermal expansion. The lubrication is effected by surface migration and vapor condensation. Fig. 11 illustrates the lubrication process.

The major drawback of this kind of system is the delayed lubrication process because of the delay in oil to get heated up and ejected out of the system. Moreover, the heater activation time should be progressively increased after each operation to eject the same quantity of oil.

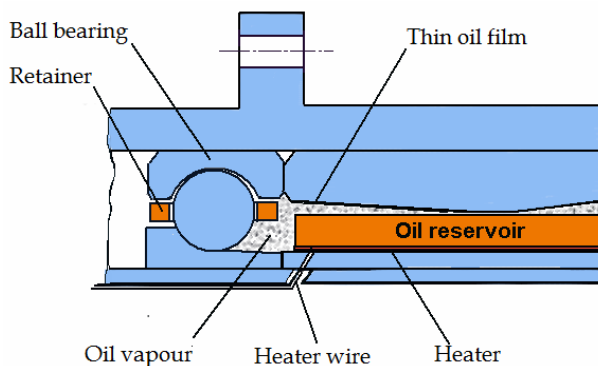

Fig. 11. Mechanism of oil transfer in static oil reservoir

5.2 Passive lubrication systems

The passive lubrication systems supplies lubricant continuously at a controlled rate irrespective of the requirement. These systems work on centrifugal force or by surface migration. Passive systems are simple in construction, but it is difficult to control the flow rate to the required amount. Different techniques are used to control the flow rate in this type of lubricators. There are a number of designs of passive lubrication systems used today by different manufacturers of attitude control wheels for spacecraft. Some of these systems are briefly discussed here.

Wick feed systems: In wick feed lubrication system (Loewenthal, et.al, 1985), a lightly spring loaded cotton wick, saturated with oil is continuously in contact with a conical sleeve adjacent to the bearings. The other end of the wick is in contact with oil in a reservoir and it absorbs and maintains its saturation level. The frictional contact causes small amount of oil to be deposited on to the contact surface. From this contact surface, oil migrates to the other end of the sleeve and then to the bearing. The oil leaving the bearing after lubrication return to the reservoir.

Rotating Lubricators: These are the most common type of lubricators currently in use and are actuated by centrifugal force due to the rotation of the lubricator. In these lubricators, the lubricant, either grease or oil, is filled in a cylindrical container and is assembled to the rotating part of the bearing unit. A lubricant bleed path is provided at the outer most layer of lubricant in the container. When the bearing unit is rotating, the lubricator attached to it also rotating at the same speed. The centrifugal force thus generated causing the lubricant to flow out through the bleed path. The oil oozing out of the lubricator is guided to the bearings mounted on either side of the lubricator. Different types of rotating lubricators are briefed under.

The ooze flow lubricator invented by Hashimoto (Hashimoto, 2001) is a novel concept. In this, the lubricator is fitted to the outer spacer of the bearing unit, the ends of which are formed as the bearing outer race. The reservoir to store the lubricant is formed by the two cylindrical components of the assembly. A set of precision turned helical grooves made at the interface of the inner and outer part of the lubricator. The helical grooves run in the axial direction and deliver lubricant to each of the bearings. The rate of flow is controlled by the dimensions of the helical groove and speed of rotation of the bearing shaft. The design life of the system is claimed as 15 years when operating at 12 000 rpm. The space cartridge bearing system presented by Kingsbury et al. (Kingsbury, et.al., 1999) and the oozing flow lubricator presented by Jones et al. (Jones, et.al., 1997) and Singer et al. (Singer, et.al., 1994) resemble the ones mentioned above. Fig. 12 shows the space bearing cartridge with oozing flow lubricator.

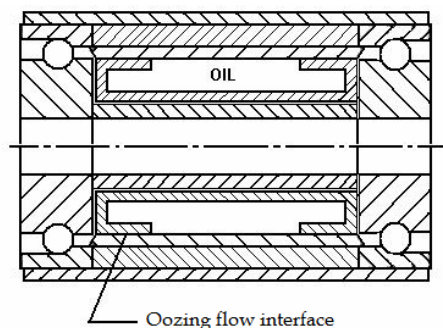

Fig. 12. Space cartridge bearing system with oozing flow lubricator (Kingsbury, et.al, 1999)

The centrifugal oil lubricator (Sathyan, et.al., 2008) contains a reservoir cup and an inner sleeve made of aluminum and machined with a high degree of accuracy. When the outer cup and inner sleeve are assembled, a cavity is formed where the lubricant is filled. The capacity of the reservoir is about 5 cc. The interfaces of the outer cup and inner sleeve are electron beam welded to make the reservoir leak proof. Two orifices of 150 μm diameter are made on the periphery of the outer cup in diametrically opposite locations. A filling hole is provided on one of the faces of the outer cup to fill oil as shown in Fig. 13 (a). The lubricator is designed to mount on the rotating outer spacer of the bearing unit, which separates the bearings. Lubrication of each bearing in the assembly is carried out by separate lubricators mounted adjacent to each bearing as shown in Fig. 13 (b).

When the bearing unit starts rotating, the centrifugal lubricator attached to the outer spacer of the bearing unit also rotates along with the bearings. The centrifugal force due to rotation of the reservoir generates pressure head in the stored oil, which is the maximum at the outer layer of oil near the orifices. The pressure thus developed forces the oil out through the orifices provided on the outer cup. The oil coming out of the orifice is directed to the bearing surface by suitably designed flow paths.

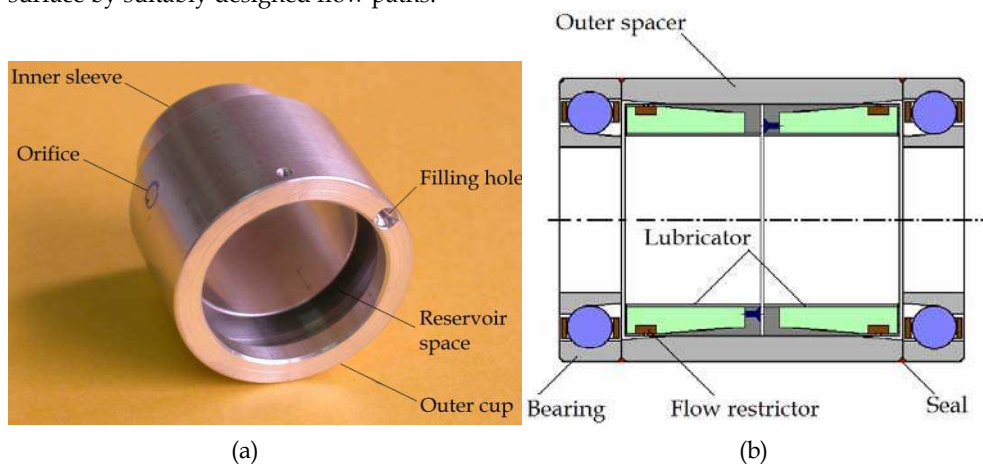

Fig. 13. Centrifugal oil lubricator components (a), schematic view of lubricator assembly (b)

It is estimated that the pressure developed at the orifice is nearly 12,000 Pa when the lubricator is running at 5000 rpm. Under this pressure, it is only a matter of hours to empty the reservoir through the 150 μm orifice. To avoid this and to control the flow rate to the lowest possible value, a flow restrictor is introduced at the orifices. Here, a piece of isotropic porous material is used to control the flow rate as shown in Fig. 13 (b). The flow area through the restrictor is used to control the flow rate to achieve the required flow rate. The material of the restrictor must be homogeneous and isotropic to ensure uniform flow rate. The particle size and porosity are the two important factors, which determine the permeability or fluid conductivity of the porous material. It is observed that sintered polyimide is an ideal material for this application. Polyimide spherical particles are available in a variety of sizes. Using graded particles sintered filter porosity can be very accurately controlled. Small pieces of branded sintered polyimide, MELDIN- 9000, is used as flow restrictor.

The rate of flow from the lubricator is given by the equation:

$$q = \frac{\alpha A \rho \omega^2}{2\mu L} (R^2 - r^2) \quad (4)$$

where, α is the permeability of the restrictor material in m^2 , A is the cross sectional area of flow through the restrictor in m^2 , ρ is the density of the lubricant in kg/m^3 , ω is the angular speed of the reservoir in rad/sec , μ is the dynamic viscosity of oil in $\text{N}\cdot\text{sec}/\text{m}^2$, L is the thickness of the restrictor in m , R is the radius of oil outer layer in m , r is the instantaneous radius of oil inner layer in m , and q is the flow rate in m^3/sec .

It is understood from Eq. 4 that the flow rate is directly proportional to the pressure of oil at the inlet to the porous restrictor. Pressure at the inlet of the restrictor is proportional to the speed of rotation and mass of liquid column above it. The pressure and thus the flow rate are the maximum when the reservoir is full and both become zero at the end of life, as shown in Fig. 14. The time to reach the zero flow rate depends on various operating parameters such as flow diameter, operating speed, temperature, and initial quantity of oil filled. Since the flow rate is proportional to the left out quantity of oil in the reservoir, the required flow rate can be obtained by filling the quantity corresponding to the flow rate as obtained from Eq. 4.

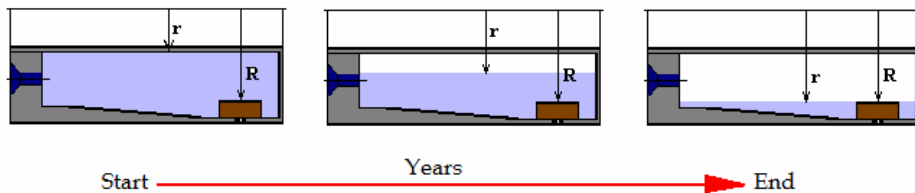

Fig. 14. Variation of oil quantity in the reservoir with time

The predicted performance of a lubricator having $150 \mu\text{m}$ flow diameter is shown in Fig. 15, obtained for operating speed and temperature 5400 rpm and 40°C respectively. It is seen that the initial flow rate is $0.037 \text{ mg}/\text{h}$ and the flow rate at the 20th year is approximately $0.006 \text{ mg}/\text{h}$. The total oil expelled in 20 years is 3000 mg , which is only 60% of the total capacity of the reservoir, 5 cc .

Another version of centrifugal oil lubricator is shown in Fig. 16 (a). This design is meant to provide a delay in supplying the lubricant to the bearing during the initial stage of operation. The capacity of the reservoir is 4 cc and the initial flow rate is about $0.02 \text{ mg}/\text{h}$. It is understood from Section. 5 that the bearings are assembled with an initial charge of approximately 100 mg and with this initial oil, it can perform upto 3 years. If lubricant is supplied during this period, it may cause increased viscous drag and resultant higher power consumption of the wheel. To avoid this and maintain the frictional loss to minimum, a delay mechanism is introduced to the centrifugal lubricator. This is achieved by mounting a dry porous material sleeve in between the lubricator outlet and the bearings as shown in Fig. 16 (b). The sleeve absorbs the oil coming out of the lubricator and get saturated. Once saturated, it start giving oil to the bearings. The porosity of the sleeve material is 28% of volume and it can hold nearly 300 mg oil. Assuming a flow rate of $0.02 \text{ mg}/\text{h}$ from the lubricator, it would take about 21 months to saturate the porous sleeve with oil. The oil from the lubricator start reach the bearings only after this period and thus prevents the bearings from running with excess bearing friction due to high viscos drag.

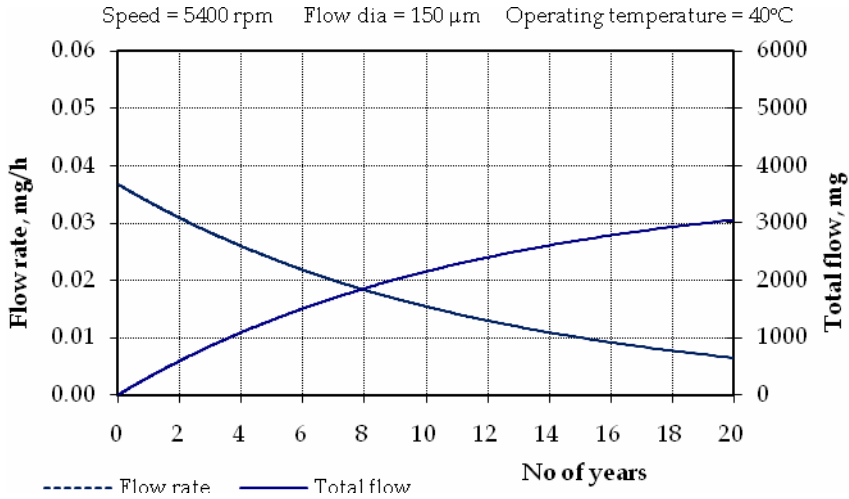

Fig. 15. Predicted performance of a lubricator with 150 μ m flow diameter at 40°C

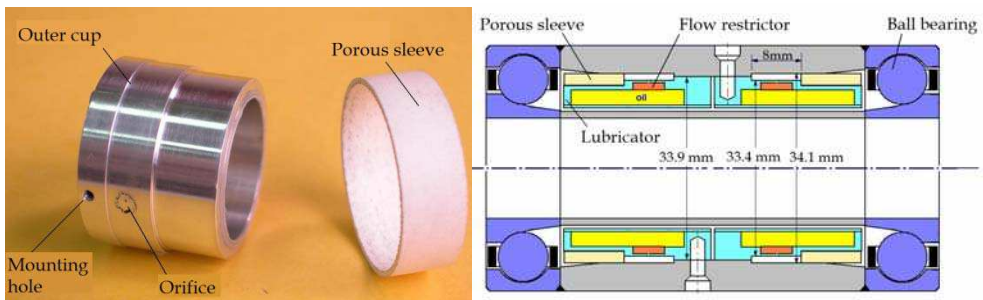

Fig. 16. Centrifugal lubricator with nylasint sleeve (a), schematic of lubricator assembly (b)

6. Conclusion

In this chapter, a brief overview of the tribological problems of the attitude control wheels is presented. The information related to momentum/reaction wheels, bearing units, lubrication requirements and various lubricants is provided. Various lubrication systems used in the past and present attitude control wheels are concisely described. A few lubrication systems developed by the authors for the future attitude control wheels requiring very long mission life are also elucidated.

7. References

Auer, W. (1990). Test Results and Flight Experience of Ball Bearing Momentum and Reaction Wheels. Proc. the 24th Aerospace Mechanisms Symposium. 1990, pp 273-287.

Bedingfield, K. L.; Leach, R. D.; Alexander, M. B. (1996). Spacecraft System Failures and Anomalies Attributed to the Natural Space Environment. NASA reference publication 1390, August 1996. Marshall Space Flight Center, MSFC, Alabama .

- Bertrand, P. A. (1993). Oil adsorption into cotton-phenolic material. *Journal of Materials Research*, 1993;8(7):1749–57, IISN: 0884-2914.
- Boesiger, E. A., Warner, M. H. Spin bearing retainer design optimization. In: *Proceedings of the 25th aerospace mechanisms symposium*, NASA conference publication, vol.3113,1991.p.161–78.
- Boesiger, E. A., Donley, A. D., Loewenthal, S. (1992). An analytical and experimental investigation of ball bearing retainer instabilities. ASME Transactions, *Journal of Tribology*, vol.14, no.3, July 1992, p. 530-539, IISN: 0742-4787.
- Briscoe, M. H.; Aglietti, G. S. (2003) Spacecraft mechanisms, In: *Spacecraft System Engineering*, Fortescue, P.; Stark, J.; Swinerd, G. 501-529, John Wiley & Sons, ISBN: 0 471 61951 5, England
- Burt, R. R.; Loffi. R. W. (2003). Failure Analysis of International Space Station Control Moment Gyro. *Proceedings, 10th European Space Mechanisms and Tribology Symposium*, pp-13 – 25, ISBN: 92-9092-834-4, Spain, September 2003, ESA Publication.
- Coy, J. J.; Rama, S. R.; Dennis, P. T. (1979). Comparison of predicted and measured elastohydrodynamic film thickness in a 20 millimeter-bore ball bearing. *NASA Technical Paper 1542*; October 1979.
- Dowson, D. (1995). Elastohydrodynamic and micro-elastohydrodynamic lubrication. *Wear* 1995; 190: 125–38.
- Dube, M. J.; Bollea, D.; Jones Jr, W.R.; Marchetti, M.; Jansen, M. J. (2003). A new synthetic hydrocarbon liquid lubricant for space application. *Tribology Letters*, 2003; 5(1).
- Fote, A. A., Slade, R. A., Feuerstein, S. (1978). The prevention of lubricant migration in spacecraft. *Wear* 1978; 51:67–75, ISSN: 0043-1648.
- Fowzy, M. A. (1998). PFPE, A unique lubricant for a unique application. Castrol Specialty Products Division, 19980624 044, ADA347666, 01 Jan 1998, Illinois.
- Fusaro, R. L. (1992). Lubrication of Space Systems—Challenges and potential solutions. *NASA technical memorandum-105560*; 1992.
- Fusaro, R. L. (2001). Preventing spacecraft failures due to tribological problems. In: *NASA technical memorandum -210806*; April 2001.
- Glassow, F. A. (1976). Assurance of lubricant supply in wet-lubricated space bearings. In: *Proceedings of the 10th aerospace mechanisms symposium*. NASA technical memorandum, vol. 33–777; April 1976. p. 90–106.
- Guangteng, G.; Cann, P. M.; Spikes, H. A. (1992). A study of parched lubrication. *Wear*, 1992, 153:91–105. ISSN: 0043-1648.
- Gupta, P. K. (1991). Cage unbalance and wear in ball bearings. *Wear* 1991; 147: 93–104. ISSN: 0043-1648.
- Gupta, P. K. (1988). Frictional instabilities in ball bearings. *TribologyTrans* 1988; 31(2): 258–68. ISSN: 0569-8197.
- Hamrock, B. J.; Schmid, S. R.; Jacobson, B. O. (2004). *Fundamentals of Fluid Film Lubrication*. Marcel Dekker, Inc., ISBN: 0-8247-5371-2, New York.
- Hamrock, B. T.; Dowson, D. (1981). *Ball bearing lubrication: the lubrication of elliptical contacts*. Wiley, ISBN: 13-9780471035534, New York.
- Hashimoto, F. (2001). Ooze flow bearing. *United State Patent*, patent no.:6290397; September 18, 2001.

- Honeywell. (2003). Product Specification Document. Model HR 0610, Defence and Space Electronics Systems, Honeywell International Inc. N61-0098-000-000, DFOISR: 03-S-1924, December 2003. www.honeywell.com.
- James, G. E. (1977). Positive commandable oiler for satellite bearing lubrication. In: *Proceedings of the 11th aerospace mechanisms symposium*. NASA CP-2038; 1977. p. 87-95.
- Jansen, M. J.; Jones Jr, W. R.; Predmore, R. E.; Loewenthal, S. L. (2001). Relative lifetimes of several space liquid lubricants using a vacuum spiral orbit tribometer (SOT). In: *NASA-TM-2001-210966*; June 2001.
- Jones, Jr, W. R.; Jansen, M. J. (2005), Lubrication for space application, in *NASA Contractor Report-2005-213424*.
- Jones, Jr, W. R.; Jansen, M. J.; Gschwender, L. J.; Snyder, C. E.; Sharma, S. K.; Predmore, R. E. (2001). The tribological properties of several silahydrocarbons for use in space mechanisms. *J Synthetic Lubrication*, 2004; 20(4).
- Jones, Jr, W. R.; Jansen, M. J. (2000). Space tribology. In: NASA technical memorandum 2000-106392; March 2000.
- Jones, Jr, W. R., Shogrin, B. A., Kingsbury, E. P. (1997). Long-term performance of a retainerless bearing cartridge with an oozing flow lubricator for space application. In: *Proceedings of the international rolling element bearing symposium*, April 1997.
- Jones, W. R. (1993). The properties of perfluoropolyethers used for space applications. In: *NASA technical memorandum 106275*; July 1993.
- Kannel, J. W., Snediker, D. (1977). Hidden Cause of Bearing Failure. *Machine Design*, April 1977, pp. 78-82.
- Kannel, J. W., Bupara, S. S. (1977). A simplified model of cage motion in angular contact ball bearings operating in the EHD region. *J Lubr Technol*, ASME Trans 1977:395-403.
- Kannel, J. W.; Dufrene, K. F. (1986). Rolling Bearings in Space. In: *Proceedings of the 20th aerospace mechanisms symposium*. NASA conference publication 2423 (revised); May 1986. p. 121-32.
- Kingsbury, E. P.; Hanson, R. A.; Jones, W. R.; Mohr, T. W. (1999). Cartridge bearing system for space applications. Proc. 33rd Aerospace Mechanisms Symposium, *NASA Conf. Publ.* 1999, 209259, 137-143.
- Kingsbury, E. P. (1985). Parched elastohydrodynamic lubrication. *ASME Journal of Tribology* 1985;107:229, ISSN: 0742-4787.
- Kingsbury, E. (1992). Influences on polymer formation rate in instrument ball bearings. *Tribology Trans* 1992; 35:184-8. ISSN: 0569-8197.
- Kingsbury, E. (1973). Cross flow in a starved EHD contact. *ASLE Transactions* 1973, 16, p-276-280.
- Loewenthal, S.; Boesinger, E.; Donley, A. (1991). International rolling element symposium 91. Sponsored by C.S. Draper Lab and DOD, Instrument Bearing Working Group; April 8-11, 1991.
- Loewenthal, S. H.; Scibbe, H. W.; Parker, R. J.; Zaretsky, E. V. (1985). Operating characteristics of a 0.87 kWh flywheel energy storage module. In: *NASA technical memorandum 87038*; August 1985.
- Ma, J.; Mo, Y.; Bai, M. (2009). Effect of Ag nano particles additive on the tribological behaviour of multialkylated cyclopentanes (MACs). *Wear*, 266 (2009), 627-631.

- Marchetti, M.; Jones, Jr, W. R.; Pepper, S. V.; Jansen, M. J.; Predmore, R. E. (2002). In-situ, on-demand lubrication system for space mechanisms. In: *NASA technical memorandum 2002-211706*; July 2002.
- Marchetti, M.; Meurisse, M. H.; Vergne, P.; Sicreb, J.; Durand, M. (2001). Analysis of oil supply phenomena by sintered porous reservoirs. *Tribology Letters*, 2001; 10(3).
- Mia, S.; Komiya, H.; Hayashi, S.; Morita, S.; Ohno, N.; Obara, S. (2007). Viscosity loss in PFPE lubricant for space applications under EHL conditions. *Tribology Online*, 2007; 2(2), 54–8.
- Robertson, B.; Stoneking, E. (2003). Satellite GN&C Anomaly Trends. *Proceedings, 26th annual AAS Guidance and Control Conference*, AAS 03-071. February 2003, Colorado, AAS publications, California.
- Roberts, E. W.; Todd, M. J. (1990). Space and vacuum tribology. *Wear*; 1990,136, 157–67.
- Sathyan, K. (2010). Development of a centrifugal lubricator for long-term lubrication of momentum wheels used in spacecrafts. PhD thesis, University of South Australia; March 2010.
- Sathyan, K. (2003). Long-term lubrication systems for momentum wheels used in spacecrafts. MS thesis, Indian Institute of Technology Madras; September 2003.
- Sathyan, K.; Gopinath, K.; Hsu, H. Y.; Lee S. H. (2008). Development of a Lubrication System for Momentum Wheels Used in Spacecrafts. *Tribology Letters* , 32, 2008, 99–107, IISN:1023-8883.
- Sathyan, K.; Hsu, H. Y.; Lee, S. H.; Gopinath. K. (2010). Long-term lubrication of momentum wheels used in spacecrafts—An overview. *Tribology International*, 43, pp. 259–267. ISSN: 0301-679X.
- Sathyan, K.; Gopinath, K.; Hsu, H. Y.; Lee S. H. (2010). Development of a positive lubrication system for space application. *Tribology Online*, 5, 1, 2010, 40–45. ISSN: 1881-2198.
- Shapiro, W.; Murray, F.; Howarth, R. (1995). Space mechanisms lessons learned study, Volume II—literature review. In:*NASA technical memorandum 107047*; September 1995.
- Shogrin, B. A.; Jones, W. R.Jr.; Kingsbury, E. P.; Prah, J. M. (1999). Experimental Determination of Load Carrying Capacity of Point Contact at Zero Entrainment Velocity. *NASA/TM – 1999-208848*, January 1999.
- Singer, H. B., Gelotte, E. (1994). Design of a high-speed reliable ball bearing. In: *Proceedings of the 28th aerospace mechanisms symposium*. NASA conference publication, vol. 3260, May 1994. p. 279–83.
- Smith, D. W.; Hooper, F. L. (1990). Positive lubrication system. In: *Proceedings of the 24th aerospace mechanisms symposium*. NASA conference publication, vol. 3062, 1990. p. 243–58.
- Stevens, K. T. (1980). Experimental observations on torque variations caused by ball bearing cage instabilities. In: *Proceedings of Second Space Tribology Workshop*. 15-17 October 1980, ESTL Risley, UK.
- Sugimura, J.; Jones, Jr, W. R.; Spikes, H. A. (1998). EHD film thickness in non-steady state contacts. *Trans ASME J Tribology* 1998, 120:442. IISN: 0742-4787.
- Taniwaki, S.; Kudo, M.; Sato, M.; Ohkami, Y. (2007). Analysis of retainer induced disturbances of reaction wheel. *Journal of System Design and Dynamics*, vol. 1, no.2, 2007, 307–317.

- Vernier, C. G.; Casserly, E. W. (1991). Multiply-alkylated cyclopentanes (MACs): a new class of synthesized hydrocarbon fluids. *Lubrication Engineering* 1991; 47(7), 586-91.
- Zaretsky, E. V. (1990). Liquid lubrication in space. In: *NASA reference publication-1240*; July 1990.



Advances in Spacecraft Technologies

Edited by Dr Jason Hall

ISBN 978-953-307-551-8

Hard cover, 596 pages

Publisher InTech

Published online 14, February, 2011

Published in print edition February, 2011

The development and launch of the first artificial satellite Sputnik more than five decades ago propelled both the scientific and engineering communities to new heights as they worked together to develop novel solutions to the challenges of spacecraft system design. This symbiotic relationship has brought significant technological advances that have enabled the design of systems that can withstand the rigors of space while providing valuable space-based services. With its 26 chapters divided into three sections, this book brings together critical contributions from renowned international researchers to provide an outstanding survey of recent advances in spacecraft technologies. The first section includes nine chapters that focus on innovative hardware technologies while the next section is comprised of seven chapters that center on cutting-edge state estimation techniques. The final section contains eleven chapters that present a series of novel control methods for spacecraft orbit and attitude control.

How to reference

In order to correctly reference this scholarly work, feel free to copy and paste the following:

Sathyan Krishnan, Sang-Heon Lee, Hung-Yao Hsu and Gopinath Konchady (2011). Lubrication of Attitude Control Systems, *Advances in Spacecraft Technologies*, Dr Jason Hall (Ed.), ISBN: 978-953-307-551-8, InTech, Available from: <http://www.intechopen.com/books/advances-in-spacecraft-technologies/lubrication-of-attitude-control-systems>

INTECH
open science | open minds

InTech Europe

University Campus STeP Ri
Slavka Krautzeka 83/A
51000 Rijeka, Croatia
Phone: +385 (51) 770 447
Fax: +385 (51) 686 166
www.intechopen.com

InTech China

Unit 405, Office Block, Hotel Equatorial Shanghai
No.65, Yan An Road (West), Shanghai, 200040, China
中国上海市延安西路65号上海国际贵都大饭店办公楼405单元
Phone: +86-21-62489820
Fax: +86-21-62489821

© 2011 The Author(s). Licensee IntechOpen. This chapter is distributed under the terms of the [Creative Commons Attribution-NonCommercial-ShareAlike-3.0 License](#), which permits use, distribution and reproduction for non-commercial purposes, provided the original is properly cited and derivative works building on this content are distributed under the same license.