

Effects of the Long-Time Immersion on the Mechanical Behaviour in Case of Some E-glass / Resin Composite Materials

Assoc.prof.dr.eng. Camelia CERBU
*„Transilvania” University of Braşov, Faculty of Mechanical Engineering,
Romania*

1. Introduction

The chapter deals with the actual and difficult problem of analysing the mechanical structures from the perspective of using composite materials in aggressive environment. Optimising the mechanical structures, made by composite materials is a great actual and important problem that includes two of the most modern, difficult and demanded aspects in mechanical engineering. If we point out this subject, meaning the aggressive environment, we already have the complete image of an extreme actual, important and special complexity subject.

The major studies in the field of structural optimising of the components made of composite materials, followed to obtain structures of components having higher strength and rigidity, lower weight, under conditions of a lower cost. There have been analysed composite material components, for which have been varied the material structure for fibre and matrix, the orientation of the fibres in layers, the shape of component, etc. The present study proposes an objective and supplementary criterion: the conservation of the mechanical characteristics of strength and rigidity under the long time action of the aggressive environment factors.

The results presented within this chapter address to the researchers and specialists in the field of the composite materials, to the ph.d. students and students from master, etc. Concurrently, reading of this working, may establish a point of start in the researching activity in this direction because it notes some important remarks regarding the effects of the aggressive environment (humidity, basic and acid solutions, temperature, thermal cycles, electrons radiation, UV rays etc) on the degradation of the mechanical characteristics of some composite materials.

The specialists interested in the field of composite materials will find a rich source of information by establishing a method of testing the specimens made of composite materials, subjected to statically forces after maintaining in aggressive environment; recommendations concerning the polymeric composite structure, having long durability under the action of the humidity and variations of temperature.

When an organic matrix composite is exposed to humid air or to a liquid, both the moisture content and temperature of the composite material may change with time. These changes affect the mechanical characteristics (Corum et al., 2001; Pomies et al., 1995; Cerbu, 2007; Takeshige et al., 2007).

Glass fibre reinforced resins are used widely in the building and chemical industry (wall panel, window frames, tanks, bathroom units, pipes, ducts, boat hulls, storage tanks, process vessels), automotive industry, aerospace industry. These structure elements may also be exposed to the environmental conditions (moisture, temperature etc).

In the last years, it was published many scientific papers concerning to the mechanical behaviour in wet environment of the composite materials and of the structure made of composite materials. For example, it was shown that the long-time immersion of the polymeric composite materials in water, seawater or detergent solutions, lead to the degradation of the mechanical characteristics (Corum et al., 2001; Pomies et al., 1995 ; Cerbu, 2005; Cerbu, 2007). Experimental results (Cerbu s.a. 2009) also demonstrated the influence of the immersion time on the degradation of the mechanical characteristics of some polymeric composite materials.

A recent paper (Takeshige et al. 2007) investigated some interactions between mechanical and chemical fatigue in case of some resin composite materials. Therefore, in that research was remarked that the fatigue crack propagation is retarded under humid conditions but accelerated after water immersion.

Some recent works shown the new tendencies from the manufacture field of the composite materials by recycling of the wood wastes (Adhikary s.a. 2008), plastic wastes, polyetilena waste, paper, CDs / DVDs (Cerbu s.a. 2009) and so forth. Consequently, some of the new composite materials were studied from moisture absorption point of view. For example, Adhikary s.a. (2007) analysed the long-term moisture absorption and thickness swelling in case of some specimens made of recycled thermoplastics reinforced with pinus wood flour.

An interesting book (Klyosov 2007) focused on wood-plastic composites regarding the particularities of their fabrication; the effects of cellulose fillers, mineral fillers and coupling agents on their mechanical properties. It also showed the effects of the moisture absorption on changes of some mechanical characteristics. Thus, it was experimentally demonstrated that the flexural strength and flexural modulus E increased in case of an water-saturated board made of a commercial wood-plastic composite material.

The first of all, the present chapter proposes the analysing of the effects of moisture absorbed concerning the changing of the mechanical characteristics of four kinds of polymeric composite materials randomly reinforce with chopped glass fibres. Both the nature of resin and the immersion environment, were analysed regarding their effects on the changing of the mechanical characteristics.

On the other hand, it focus on the using of the wood flour obtained by recycling of the wood wastes from industry to manufacture of hybrid composite materials. The new polymeric composite material described within this section, is reinforced with both glass woven fabric EWR145 (145g/m²) layed in six layers and wood flour.

It will be comparatively shown the results concerning to the mechanical characteristics (tensile strength, flexural modulus E , flexural maximum stress σ_{\max}) determined by tensile tests and flexural tests (method of the three points), before and after immersion in different environments (water, natural seawater, detergent solution). The results will be compared with the ones obtained in case of four kinds of composite materials randomly reinforced only with chopped glass fibres, free of admixture of wood flour. Moreover, it will be comparatively analysed the data concerning the quantity of the moisture absorbed and the its effect on the change of the mechanical characteristics.

2. Materials. Work method

The first of all, it was manufactured six laminated composite plates whose material structures are different. In this work, E-glass fibres (50 mm length) were used to randomly reinforce four kinds of resins: two polyester resins (Heliopol 8431 ATX and Polylyte 440-M880); an epoxy resin (LY554); a vinyl-ester resin (Atlac 582). These composite materials had the average volume fibre ratio equal to 26%, while the weight fibre ratio was 40%. Another two plates having the dimensions 350 x 250mm² and 8mm in thickness, were manufactured by using a polyester resin reinforced with both glass woven fabrics EWR145 (six layers) and wood flour (oak wood flour or fir wood flour).

Then, the plates were cut to obtain the specimens according to the european standards concerning of determination of the both tensile properties (ISO 527) and flexural properties (SR EN 63). A total number of 164 specimens were manufactured for tensile tests (Table 1) while 194 specimens were prepared for the flexural tests (Table 2).

It may be noted that all sides of a half of the total number of specimens reinforced only with E-glass fibres, were coated using the resins used for the matrix while the others were not coated.

No.	Composite material	Number of specimens			
		Dry	Environment		
			Water	Detergent solution	Seawater (Black Sea)
1	E-glass / polyester Heliopol 8431 ATX	5	12	12	12
2	E-glass / polyester Polylyte 440-M880	5	12	12	12
3	E-glass / epoxy LY 554	5	12	12	12
4	E-glass / vinyl-ester Atlac 582	5	12	12	12

Table 1. Specimens for tensile test

No.	Composite material	Number of specimens			
		Dry	Environment		
			Water	Detergent solution	Seawater (Black Sea)
1	E-glass / polyester Heliopol 8431 ATX	5	12	12	12
2	E-glass / polyester Polylyte 440-M880	5	12	12	12
3	E-glass / epoxy LY 554	5	12	12	12
4	E-glass / vinyl-ester Atlac 582 composite	5	12	12	12
5	E-glass EWR145 / fir wood flour / polyester Colpoly 7233	5	5	-	5
6	E-glass EWR145 / oak wood flour / polyester Colpoly 7233	5	5	-	5

Table 2. Specimens for flexural test

Then, the specimens were kept at the room temperature and dried environment for three weeks.

Additionally, some specimens were stored in an oven at 30 ± 1°C and weighted to ensure that they were dried prior to the immersion in water (SR EN ISO 62, 2008). Water (Fig. 1, a),

detergent solution (Fig. 1, b) and fresh natural seawater from Black Sea (Fig. 1,c) at room temperature (20 °C) were used as wet environments. Stands were used to maximise the contact surface between specimens and water (see the detail presented in the Fig. 1, c). The salinity of the natural seawater was approximately of 1.6%. The water tanks were covered to minimise evaporation and the water was changed every month to keep conditions constant.

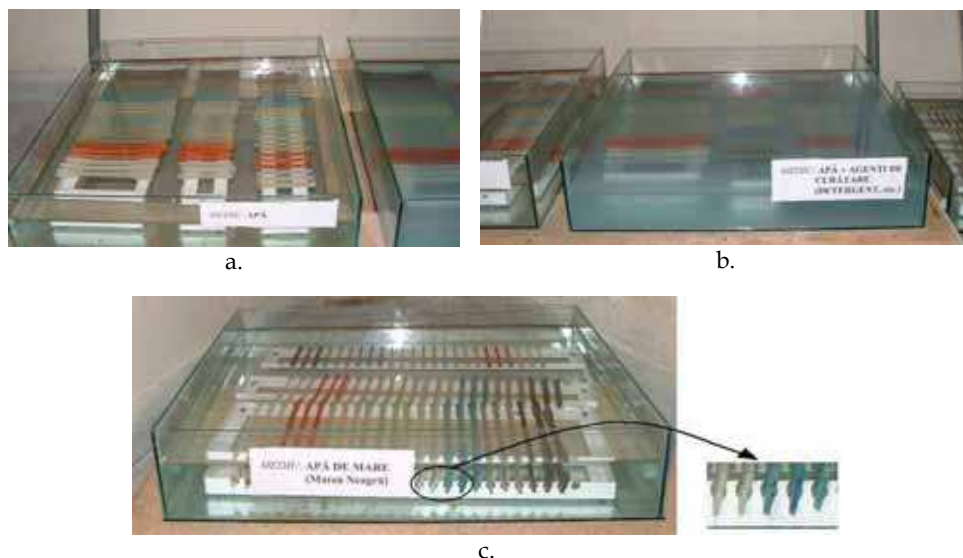

Fig. 1. Environments a. Water ; b. Water / detergent mix c. Seawater (Black Sea);

No.	Composite material	Specimen type	Immersion time t (hours)		
			Environment		
			Water	Detergent solution	Seawater (Black Sea)
1.	E - glass / polyester Heliopol 8431 ATX	Uncoated	7197	7134	6987
		Coated	7197	7134	6987
2.	E - glass / polyester PolyLite 440-M880	Uncoated	7197	7134	6987
		Coated	1803	1732	2762
3.	E - glass / epoxy LY 554	Uncoated	7197	7134	6987
		Coated	7197	7134	6987
4.	E-glass / vinyl-ester Atlac 582 composite	Uncoated	2975	2865	6987
		Coated	1821	1732	2762
5.	E-glass EWR145 / fir wood flour / polyester Colpoly 7233	Uncoated	5612		5612
6.	E-glass EWR145 / oak wood flour / polyester Colpoly 7233	Uncoated	5853	-	5853

Table 3. Immersion times for the composite materials tested

The times of immersion in water were different in case of the composite materials tested (Table 3). To monitor the uptake of water, quantified by the moisture content m , the specimens were periodically removed from tanks, superficially dried with absorbing paper and weighted by using an electronic balance (maximum mass 250 g) accurate within $\pm 0.0001\text{g}$.

After long-time immersion, the specimens were subjected to both tensile test and flexural test by the method of the three points (SR EN ISO 178, 2001). LR5K Plus machine manufactured by LLOYD Instruments, was used for mechanical testing of the composite specimens involved. The maximum force provided by the testing machine is $F_{\max} = 5\text{kN}$.

The shape and the dimensions of the tensile specimens are shown in the figure 2. Diagrams having the coordinates force - elongation ($F-\Delta l$) coordinates were directly recorded from tensile machine.

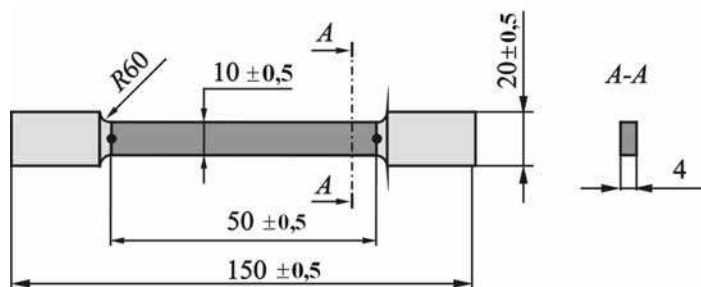

Fig. 2. Specimen for tensile test

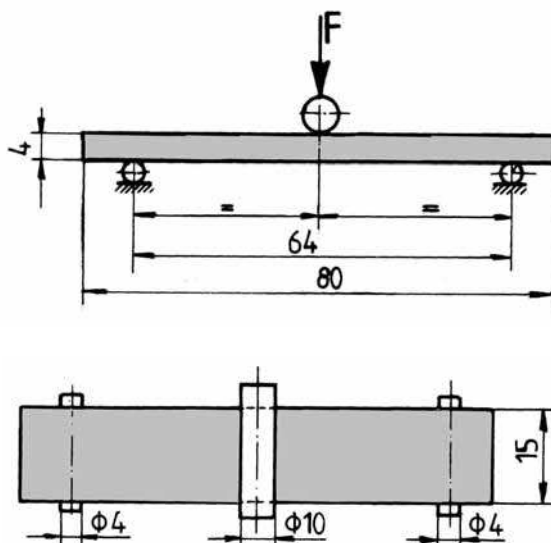

Fig. 3. Specimen used in flexural test



Fig. 4. Specimen made of E-glass / polyester Heliopol 8431 ATX during flexural test



Fig. 5. Specimen made of E-glass EWR145 / oak wood flour / polyester Colpoly 7233 during flexural test

The loading scheme (three-point method) is shown in the figure 3. The dimensions of the specimens are valid only for specimens reinforced only with E-glass fibres because these are functions of the specimen thickness. In case of the flexural tests, the span between the supports was accorded with the specimen thickness (SR EN ISO 62, 2008).

Figures 4 and 5 show two photos of specimens during the flexural test. The specimens shown are made of E-glass / polyester Heliopol 8431 ATX composite material (Fig. 4) and E-glass EWR145 / oak wood flour / polyester Colpoly 7233 (Fig. 5), respectively. It may be observed that the deformations are much more significant in the case of the specimens made with wood flour (Fig. 5) than in the case of the specimens reinforced only with glass fibres (Fig. 4).

The speed of loading was 3mm/min. in the case of the specimens made of the composite materials filled with wood flour and 1.5mm/min. in the case of the other four kinds of composite materials tested, respectively. The speed of loading was greater in the case of additionally reinforcing with oak wood flour because this composite material is much more flexible. Consequently, the time of the flexural test was approximately 40min. when the speed of loading was equal to 1.5mm/min., in the case of this composite material. It was remarked that the time of the flexural test halved by doubling of the loading speed while

the shape of the curve obtained was approximately the same. It may be mentioned that the time of the flexural test was approximately equal to 10min. when the speed of loading was 1.5mm/min., in case of the specimens reinforced only with the E-glass fibres.

Before each mechanical test of a specimen, the dimensions of the cross-section were accurately measured (0.1mm) and then, they were considered as input data in the software program of the machine.

In case of the flexural testing, the testing equipment allowed to record pairs of values (force F and deflection v at midpoint of the specimens) in form of files having up to 3000 recordings. The testing machine also gave the results of a statistical calculus for the set of the specimens tested. Experimental results recorded during the flexural tests, were graphically drawn using $F - v$ coordinates and finally, the following quantities were computed:

- flexural modulus E of the composite material

$$E = \frac{1}{48} \cdot \frac{l^3}{I_z} \cdot \frac{\Delta F}{\Delta v} \quad (1)$$

- flexural strength σ of the composite material:

$$\sigma = \frac{M_{bz \max}}{W_z}, \quad (2)$$

where $l = 64 \text{ mm}$ represents the span of the specimen between simple supports (Fig. 3), I_z - moment of inertia, W_z - elastic cross-section modulus, $M_{bz \max} = Fl/4$ - maximum value of the bending moment. Formula used for the flexural modulus E is a good approximation because

$\frac{l}{h} = 16$, where h represents the thickness of the specimen and one can neglect the effect of the shearing force.

3. Results

3.1 Water absorption

The first, moisture behaviour was analysed. The absorption data were shown in the figures 6 – 9 for all composite materials reinforced only with glass fibres. Important remarks are noted by analysing these results.

- Moisture absorption in composite materials depends on the resin used for matrix and type of the wet environment. The absorption process is a long-term process in case of the composite materials tested.
- E - glass / Heliopol 8431 ATX and E-glass / PolyLite 440-M880 composites closed the saturation point after 7000 hours of immersion time while the moisture content was approximately the same.
- E-glass / epoxy LY 554 composite does not reach the saturation point after 7000 hours of immersion (Fig. 8) and moisture content is much more greater than in case of the others three composite materials (Fig. 6, 7 and 9). E-glass / epoxy LY 554 composite material absorbs more water than seawater or detergent solution.
- Glass-reinforced polymers absorb more water than seawater. Rate of diffusion of the water through composite materials analysed is greater than that of the seawater.
- Sodium chloride molecules contained in seawater (as well as sulphate) appear to be limiting the diffusion of water into the matrix material.

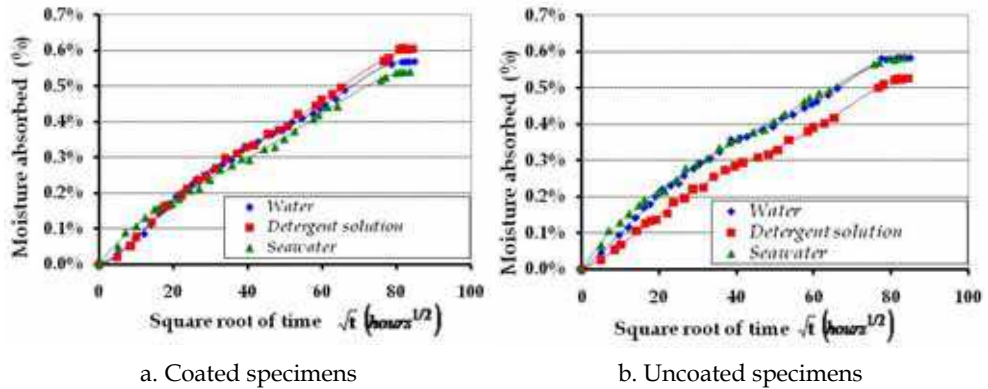

Fig. 6. Absorption data in case of E-glass / Heliopol 8431 ATX composite material

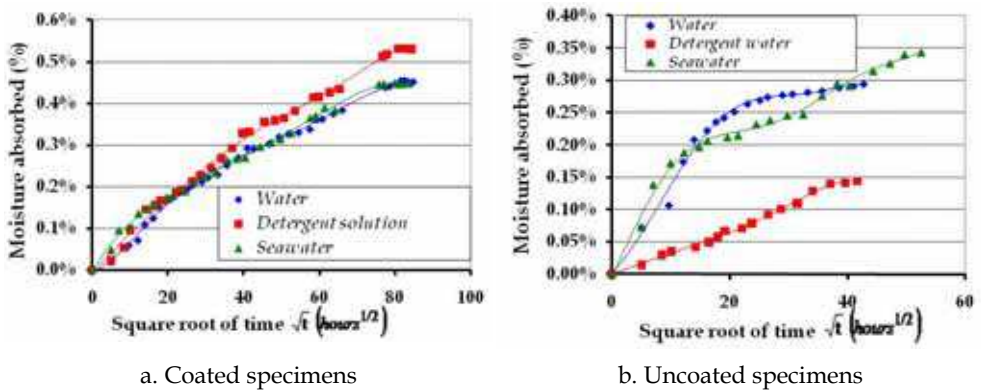

Fig. 7. Absorption data in case of E-glass / PolyLite 440-M880 composite material

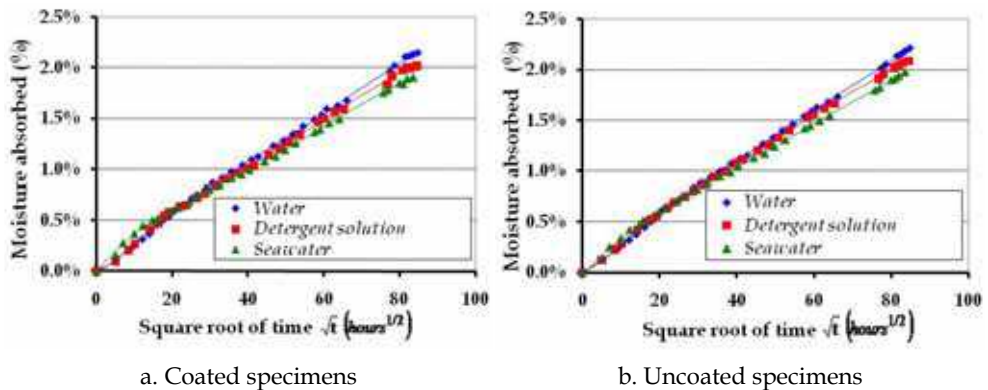

Fig. 8. Absorption data in case of E-glass / epoxy LY 554 composite material

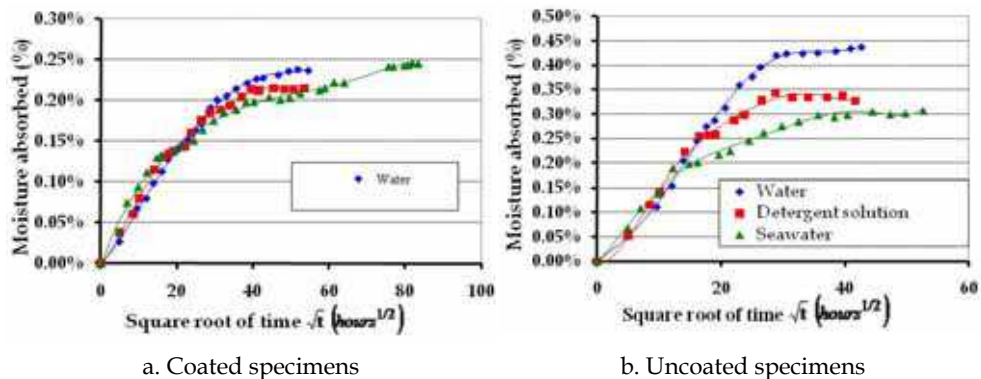

Fig. 9. Absorption data in case of E-glass / vinyl-ester Atlac 582 composite

The absorption curves recorded in case of the two hybride composites are drawn in the figure 10 in case of the immersion in water and in the figure 11 in case of the immersion in seawater.

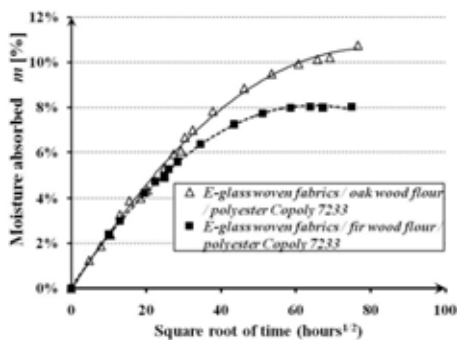

Fig. 10. Data of the absorbed moisture during immersion in water in case of the E-glass woven fabrics / wood flour / polyester

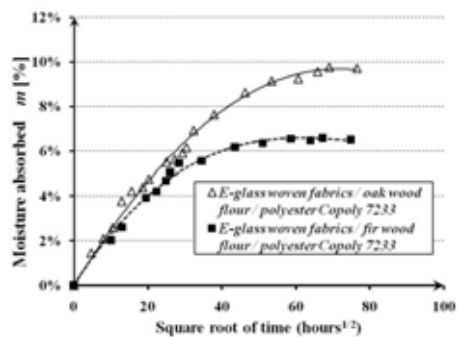

Fig. 11. Data of the absorbed moisture during immersion in seawater in case of the E-glass woven fabrics / wood flour / polyester

It may be easily observed that the two absorption curves recorded in case of the composite material filled with fir wood flour is located below the one recorded in case of the other one composite filled with oak wood flour. The cause may be assigned to resinous nature of the fir wood. Therefore, the greater resin content of the fir wood flour acts as a barrier against the water absorption. The average value of the water content (Fig. 10) was 10.73% while the seawater content (Fig. 11) recorded was 9.72% after immersion during 5853 hours, in case of the composite filled with oak wood flour. In case of the other one composite material filled with fir wood flour, the water content (Fig. 10) was equal to 8.02% while the seawater content was 6.50% after 5612 hours of immersion. Therefore, like the other previous works showed, it was recorded again a smaller quantity of the moisture absorbed during the immersion in seawater than in case of the immersion in water. The salts of the seawater act again like a barrier against the moisture absorption.

There is a small difference between the absorption curves recorded during the first 400-600 hours of immersion. It follows that the diffusivity of the moisture inside the composite material, has approximately the same value in the both cases: water environment and seawater environment.

3.2 Mechanical behaviour in tensile test after immersion in different environments

After approximately 7000 hours of immersion (≈ 10 months) the tensile specimens made of polymer resins reinforced only with glass fibres, were subjected to the tensile test. A photo of these specimens after the tensile test, is shown in the figure 12.

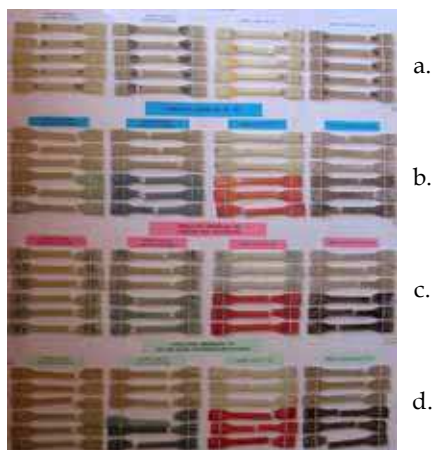

Fig. 12. Tensile Specimens reinforced only with E-glass fibres after flexural test: a. dried specimens; b. specimens after immersion in water; c. specimens after immersion in detergent solution; d. specimens after immersion in seawater

Comparatively analysing of the experimental results (Fig. 13 - 16) obtained in case of both dried and wet specimens it may observe:

- Tensile strength decreases in case of all composites;
- Decreasing of the tensile strength (40 %) is greater for the specimens made of E-glass / Heliopol 8431 ATX and E-glass / epoxy LY 554 composites after immersion in water than in case of the other two environments (Fig. 10 and 12);

- Conservation of the tensile strength was not very different if all sides of the specimens were coated using the resin of the matrix of the composite;
- Tensile strength of the specimens decreases with 10 - 20 % in case of the immersion in seawater and water / detergent mix (Fig. 10 - 12). The reason could be that moisture content was much smaller in case of these environments.

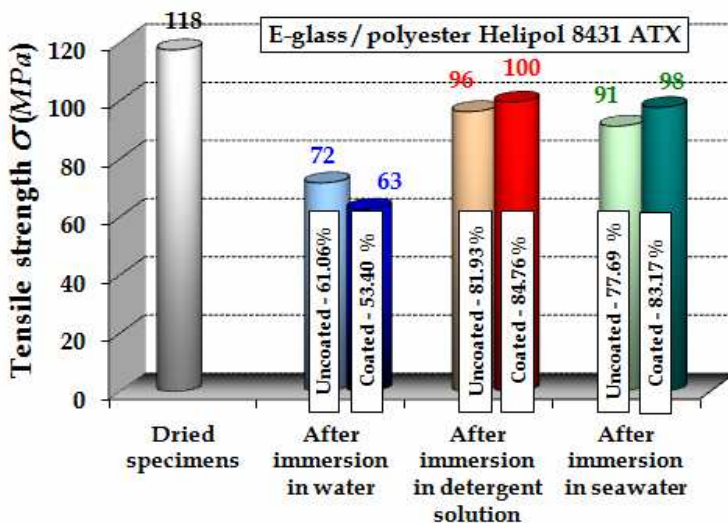

Fig. 13. Changes of the tensile strength in case of E-glass / Heliopol 8431 ATX composite

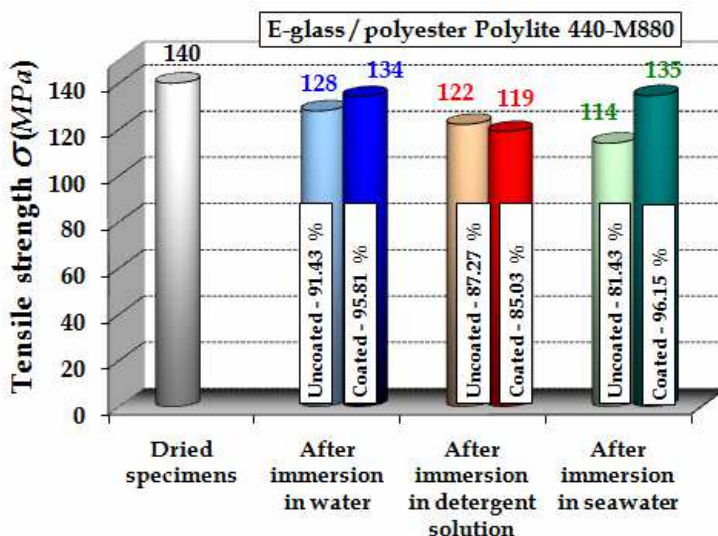

Fig. 14. Changes of the tensile strength in case of E-glass / PolyLite 440-M880 composite

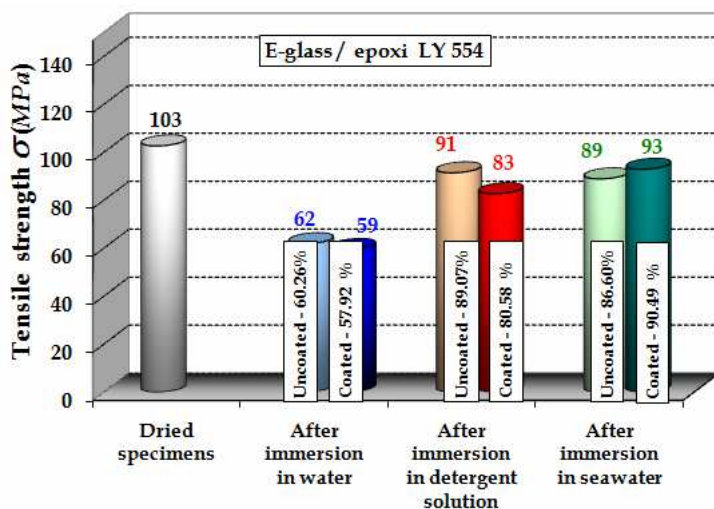

Fig. 15. Changes of the tensile strength in case of E-glass / epoxy LY 554 composite

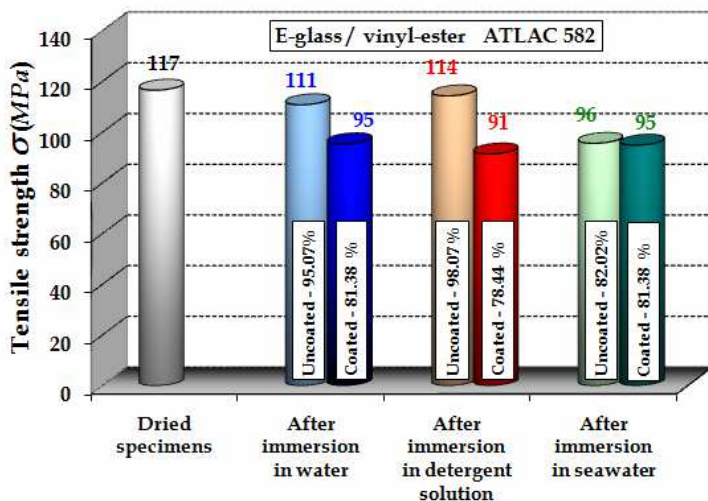

Fig. 16. Changes of the tensile strength in case of E-glass / vinyl-ester ATLAC 582 composite

3.3. Mechanical behaviour in flexural test after immersion in different environments

Then, flexural test by using the three-point method, was considered the immersion in the three kinds of wet environment. The specimens made of polymer resins reinforced with only glass fibres, after they were subjected to the flexural test, are shown in the figure 17. The results obtained in case of the wet specimens were compared with the ones obtained in case of the dried specimens.

Two photos of the flexural specimens filled with both E-glass woven fabrics and wood flour, after immersion in water, are shown in the figures 18 and 19, respectively.

Figures 20 – 23 comparatively show the force – deflection (F-v) curves recorded during the flexural tests, in case of both wet specimens in case of the following composite materials:

- E-glass / polyester Heliopol 8431 ATX (Fig. 20);
- E-glass / polyester PolyLite 440-M880 (Fig. 21);
- E-glass / epoxy LY 554 (Fig. 22);
- E-glass / polyester PolyLite 440-M880 (Fig. 23).

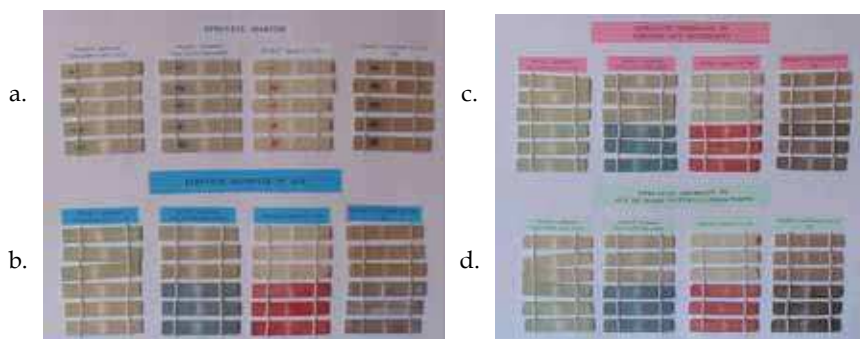

Fig. 17. Flexural specimens reinforced only with E-glass fibres after flexural test: a. dried specimens; b. specimens after immersion in water; c. specimens after immersion in detergent solution; d. specimens after immersion in seawater



Fig. 18. Flexural specimens made of E-glass EWR145 / oak wood flour / polyester Colpoly 7233 after flexural test



Fig. 19. Flexural specimens made of E-glass EWR145 / fir wood flour / polyester Colpoly 7233 after flexural test

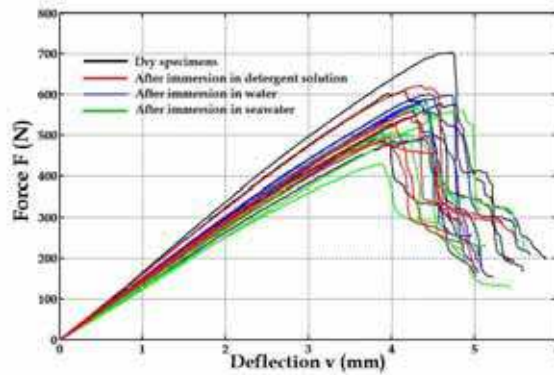

Fig. 20. Curves F-v recorded during the flexural tests in case of E-glass / polyester Heliopol 8431 ATX composite

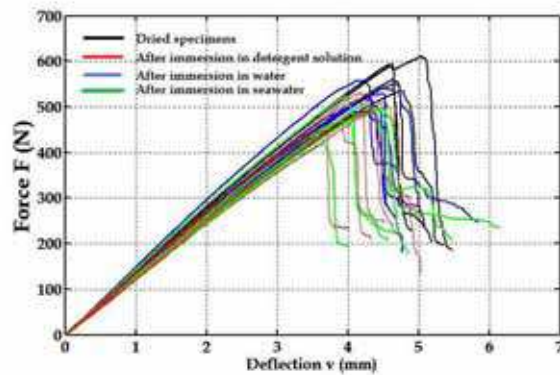

Fig. 21. Curves F-v recorded during the flexural tests in case of E-glass / polyester Polylyte 440-M880 composite

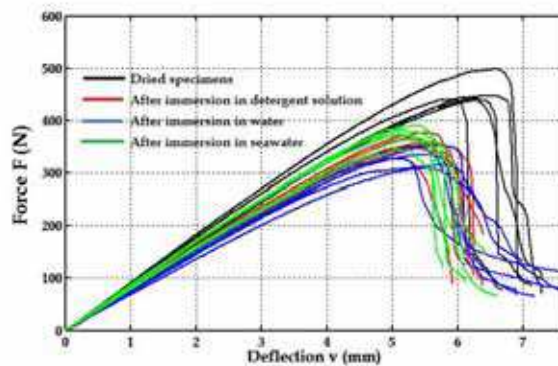

Fig. 22. Curves F-v recorded during the flexural tests in case of E-glass / epoxy LY 554 composite

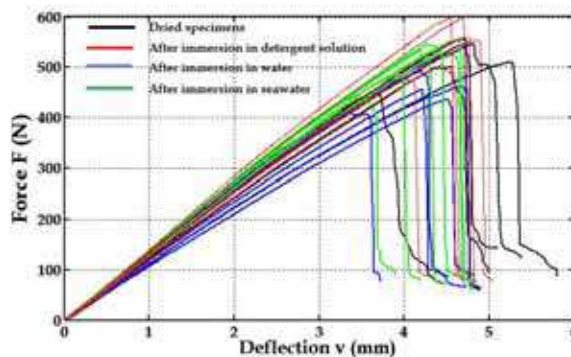

Fig. 23. Curves F-v recorded during the flexural tests in case of E-glass/vinyl-ester ATLAC 582 composite

The flexural modulus was computed on the linear portion of the force-displacement curve. Figures 24 and 25 graphically show the experimental results obtained in case of the glass / polyester composites (E-glass / Heliopol 8431 ATX and E-glass / Polylyte 440-M880), figure 26 represents the results in case of E-glass / epoxy LY 554 composite material and figure 27 shows the flexural properties measured in case of the E-glass / vinyl-ester Atlac 582 composite.

Analysing of the results of the experimental research shown in the figures 24 - 27, lead to important remarks that are noted below.

- Effects of the seawater are more pronounced than the action of the water in case of E-glass / polyester composites (E-glass / polyester Heliopol 8431 ATX and E-glass / polyester Polylyte 440-M880) as shown in figures 24 and 25.
- Decreasing of the Young's modulus E was $\approx 11\%$ while the change of the flexural strength was $\approx 12\%$ in case of the E-glass / polyester Heliopol 8431 ATX composite when the specimens were kept in seawater and detergent solution (Fig. 24). One may observe a good conservation of the flexural characteristics in case of the specimens after 9200 hours of immersion in water.
- Decreasing of the Young's modulus E was $\approx 5\%$ when the specimens were kept in water and detergent solution while the change was $\approx 10\%$ when were submerged in seawater in case of the E-glass / Polylyte 440-M880 composite (Fig. 25, a).
- A decreasing of the flexural strength was also observed in case of the E-glass / Polylyte 440-M880 composite (Fig. 25, b) - about 11%, 23% and 15% when the specimens were kept in water, seawater and detergent solution, respectively.
- On the other hand, when the E-glass / epoxy LY 554 composite was submerged in water, the decreasing of the Young's modulus was much more pronounced - about 21% (Fig. 26, a) while the decreasing of the flexural strength was approximately 31% (Fig. 26, b).
- The decreasing of the flexural strength was about 23%, 26% when the specimens were kept in seawater and detergent solution respectively, in case of the E-glass / epoxy LY 554 composite (Fig. 26, b).
- The decreasing of the Young's modulus E was about 10%, 15% when the specimens were kept in seawater and water / detergent mix in case of the E-glass / epoxy LY 554 composite (Fig. 26, a).

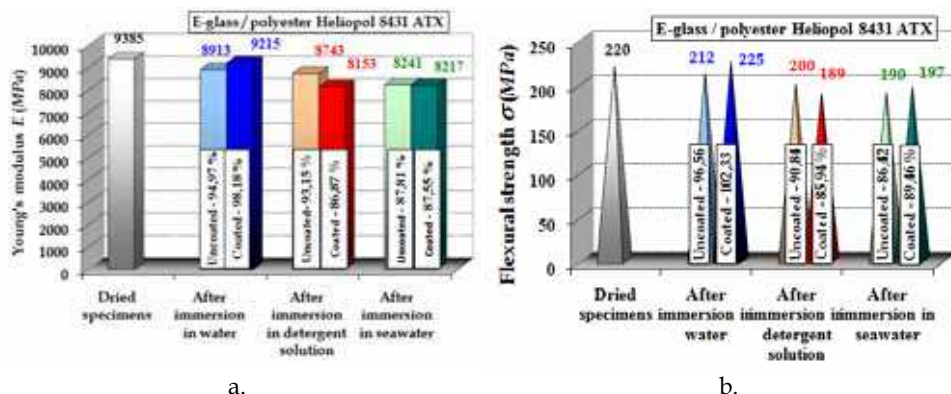

Fig. 24. Experimental results of the flexural test in case of E-glass / Heliopol 8431 ATX composite

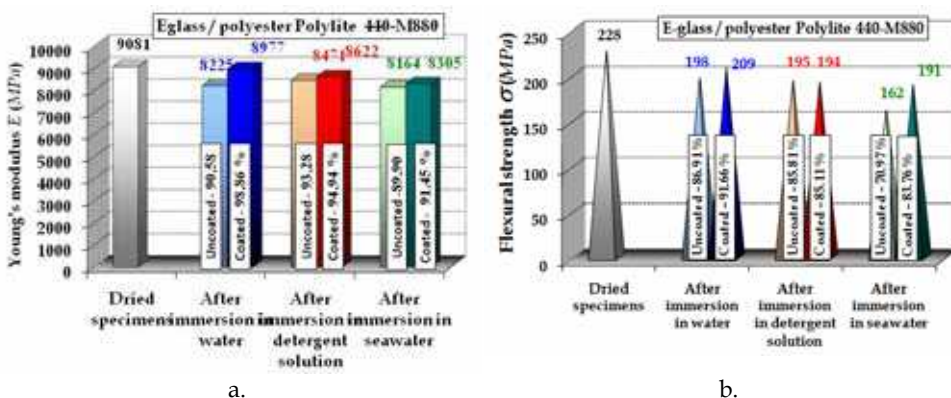

Fig. 25. Experimental results of the flexural test in case of E-glass / PolyLite 440-M880 composite

Several researchers also found that water absorption causes degradation of matrix-dominated properties such as interface and in-plane shear strengths, compressive strength and transverse tensile strength (Corum et al., 2001; Pomies et al., 1995; Cerbu, 2007; Takeshige et al., 2007). In (Pomies et al., 1995) E-glass / epoxy and carbon / epoxy composites were studied. Finally, the loss in the mechanical properties has been attributed to the plasticity of the matrix by water and degradation of the fibre/matrix interfacial bond due to moisture swelling of the matrix.

In case of the composite materials reinforced only with glass fibres, tested during our experimental research the above reason could be again the cause of the decreasing of the mechanical characteristics of the composite materials.

Experimental results recorded during bending tests, are graphically drawn in case of the hybrid composite materials: E-glass EWR145 / fir wood flour / polyester Colpoly 7233 (Fig. 28 and 29) and E-glass EWR145 / oak wood flour / polyester Colpoly 7233 (Fig. 30 and 31). It may be noted that Young's modulus was computed again, for data points located on the linear portion of the F-v curve.

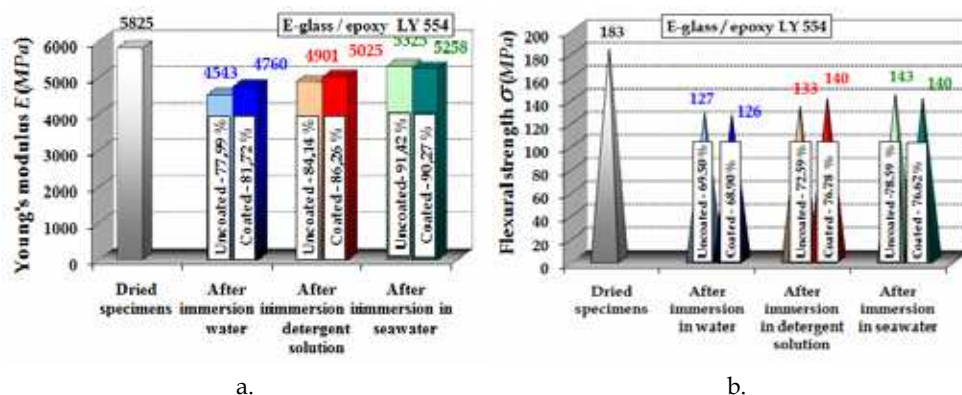

Fig. 26. Experimental results of the flexural test in case of E-glass / epoxy LY 554 composite

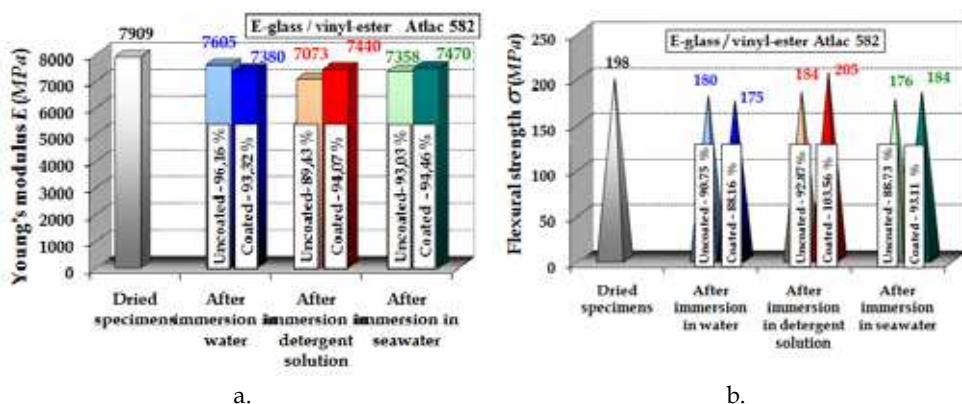

Fig. 27. Experimental results of the flexural test in case of E-glass / vinyl-ester Atlac 582 composite

The first of all, it is discussed the changing of the mechanical properties in case of the E-glass / fir wood flour / polyester composite. Young's modulus E (Fig. 28) decreases from 601.1MPa down to 356.2 MPa (with 40.7 %) after 5621 hours of immersion in water while it increases up to 766.0 MPa (with 27.5%) after the same immersion time in seawater. In the same manner, the maximum flexural stress σ_{max} (Fig. 29) decreases from 27.7 MPa down to 16.0 MPa (with 42.2%) after immersion in water and it decreases down to 23.5 MPa (with 15.2%) after immersion in seawater.

In case of the E-glass woven fabric / oak wood flour / polyester composite, it may observe generally speaking, the increasing of both Young's modulus E (Fig. 30) and maximum flexural stress σ_{max} (Fig. 31) after immersion in wet environment. Therefore, this remark confirms once again the well-known property of the oak wood concerning the hardening by aging over the years. In fact, the keeping of the materials completely immersed in water, represents an accelerate process of aging. More exactly, in case of the composite material filled with oak wood flour, Young's modulus E (Fig. 30) increases from 215.0 MPa up to

500.9 MPa (with 132.9%) after 5853 hours of immersion in water while it increases up to 482.0 MPa (with 124.2%) after the same immersion time in seawater. In the same time, the maximum flexural stress σ_{max} (Fig. 31) increases from 21.0 MPa up to 25.0MPa (with 19.05%) after 5853 hours of immersion in water while it decreases down to 17.5MPa (with 16.67%) after the same immersion time in seawater.

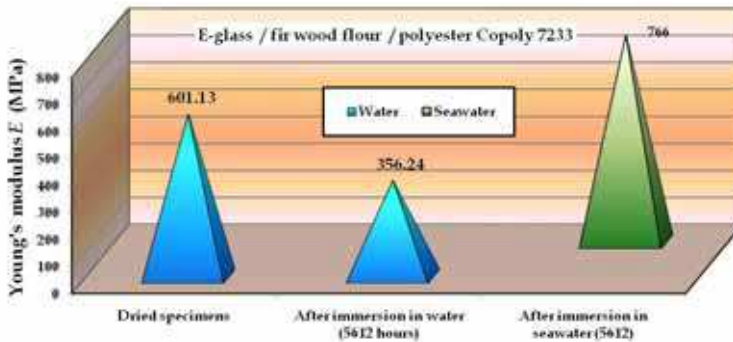

Fig. 28. The effects of water / seawater absorption on *Young's* modulus E in case of E-glass EWR145 / fir wood flour / polyester Colpoly 7233

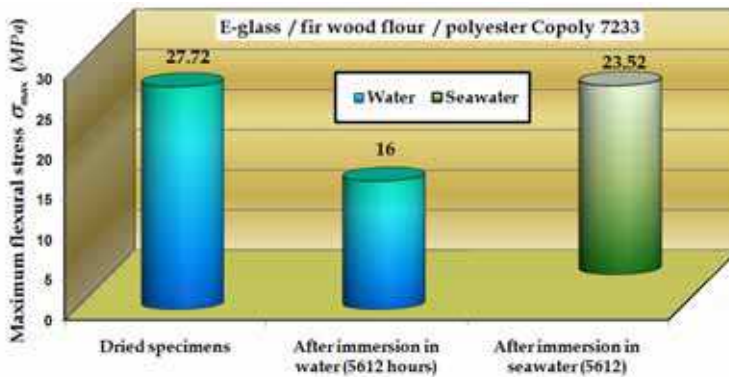

Fig. 29. The effects of water / seawater absorption on on the maximum flexural stress σ_{max} in case of E-glass EWR145 / fir wood flour / polyester Colpoly 7233

In case of the composite material filled with oak wood flour, it was also analysed the effect of the immersion time in water on the changing of the mechanical characteristics. Therefore, Young's modulus increased with 182.28 % after 861 hours of immersion in water while the increasing was only with 132.9%) after 5853 hours of immersion. With other words the increasing of the immersion time leads to a decreasing of the rigidity. The results concerning the changing of the maximum flexural stress σ_{max} show contrary that the maximum flexural stress σ_{max} increases with 7.14 % after 861 hours and it increases with 19.05% after 5853 hours of immersion.

But, the most important remark remains that concerning the values of the maximum deflection v_{max} of the midpoint of the specimens during and after the flexural test. The values recorded

for this quantity is shown in the Table 4 in case of the dried specimens made with oak wood flour. It may easily observe that the maximum residual deflection v_{max} after approximately 30 min. after flexural test had finished, was much smaller than the maximum deflection recorded at maximum load and also, than the one recorded at the final test.

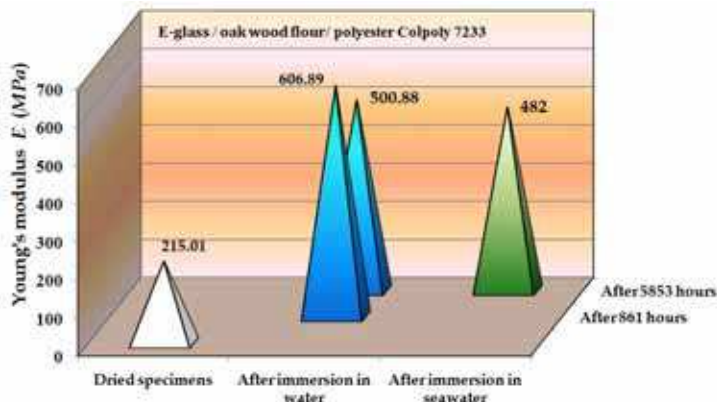

Fig. 30. The effects of water /seawater absorption on Young's modulus E in case of E-glass EWR145 / oak wood flour / polyester Copoly 7233

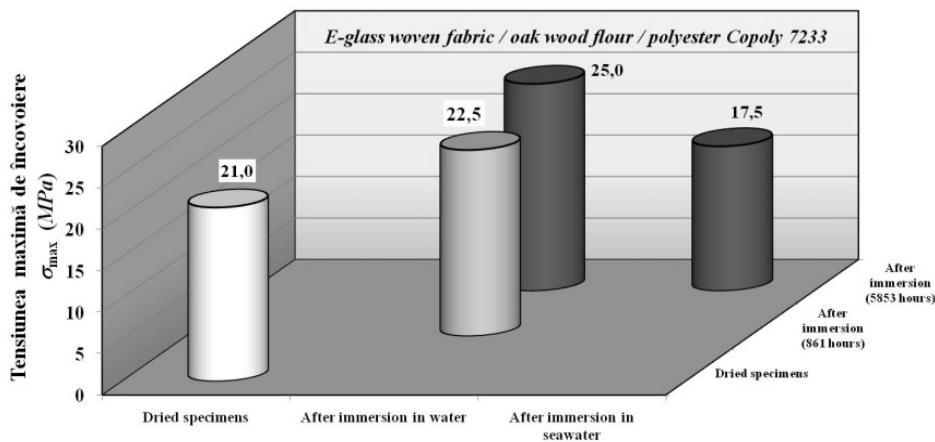

Fig. 31. The effects of water /seawater absorption on on the maximum flexural stress σ_{max} in case of E-glass EWR145 / oak wood flour / polyester Copoly 7233

The reason of this mechanical behaviour could be assigned to the wood flour used to manufacture the composite specimen because no suchlike observation was recorded in case of E-glass / polyester composite materials tested within this work. Practically, this unexpected mechanical behaviour of the new hybrid composite after the flexural test could be owing to a good combination between the rheological behaviour of wood and the shape memory, property that is assigned to the E-glass fibres.

Specimen No.	1	2	3	4	5
vmax at max. load	22.143	29.513	19.984	39.387	31.504
vmax at final of the flexural test	58.674	54.592	59.396	59.400	59.396
vmax after \approx 30 minutes after test	7.1	5.2	5.8	4.1	5.7

Table 4. Maximum values of deflection v_{\max} in case of the dried specimens made of E-glass EWR145 / oak wood flour / polyester Colpoly 7233 composite material

3.4. Failure mode

Figure 32, a shows a specimen made of the E-glass EWR145 / fir wood flour / polyester Colpoly 7233 composite material, after it was subjected to the flexural test. On the other hand, figure 32, b is a photo of the failure area aquired in case of a flexural specimen made of E-glass EWR145 / oak wood flour / polyester Colpoly 7233 composite material.

It could be observed that only 1-2 layers was partially failed during the testing of the specimens filled with wood flour. Contrary, almost all plies was failed during the flexural test in case of the specimens made of composite materials reinforced only with glass fibres (Fig. 33).



Fig. 32. Failure area occurred during flexural tests in case of the specimens additionally reinforced with wood flour: a. fir wood flour; b. oak wood flour



Fig. 33. Failure area of some specimens reinforced only with E-glass fibres, after flexural test

3.5. Degradation of the composite materials

The figure 34, a shows a photo of the two specimens made of composite material reinforced only with glass fibres, after immersion in water while the figure 34, b is a detailed photo of a damaged area located on the surface of the specimen. It was observed that more specimens analysed had similar brown spots located on the cut edge of the specimens. Since there was no spot before immersion in water, it may assume that the oxidation of the resin could be the cause of the spot appearance. The photos shown in figure 35, acquired by using a metallographic microscope, confirms this opinion.

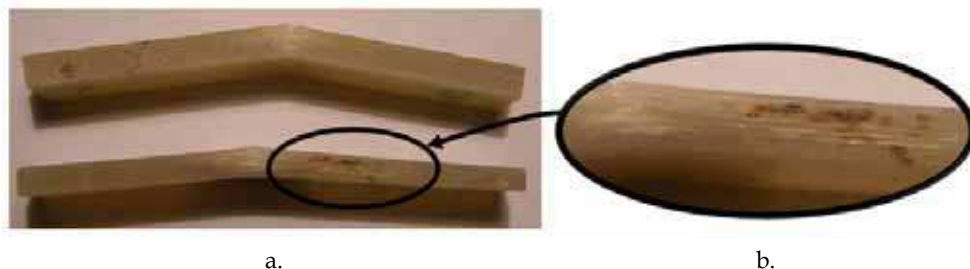

Fig. 34. Photos of the damaged composite materials

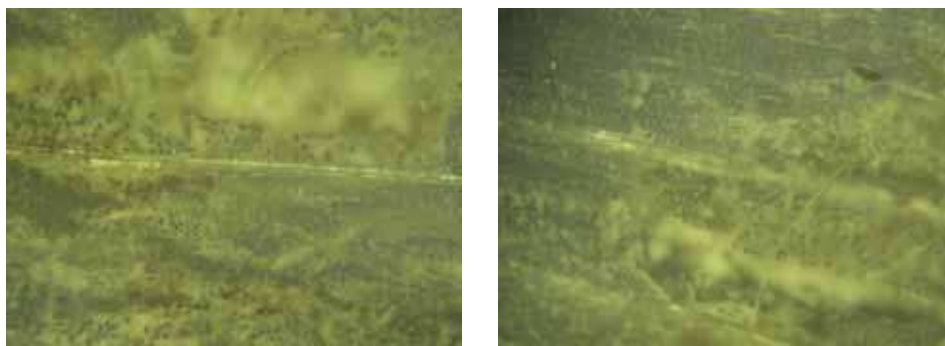

Fig. 35. Specimen photos (zoom 100x) acquired by using a metallographic microscope, after 7197 hours of immersion in water, in case of E-glass/polyester Heliopol 8431ATX composite



Fig. 36. Photo of the specimen surface made of E-glass EWR145 / fir wood flour / polyester Colpoly 7233 after immersion in water (5612 hours)

Concerning the degradation of the surfaces of the specimens made of E-glass EWR145 / fir wood flour / polyester Colpoly 7233, it was observed no spots or colour changes (Fig. 36). The figure 37 shows two photos of some specimens made of E-glass / oak wood flour / polyester composite material after 5853 hours of immersion in water (Fig. 37,a) and seawater (Fig. 37, b), respectively. It may be easily observed that more specimens analysed had similar black spots located on the cut edges of the specimens, especially in case of the specimens immersed in seawater.

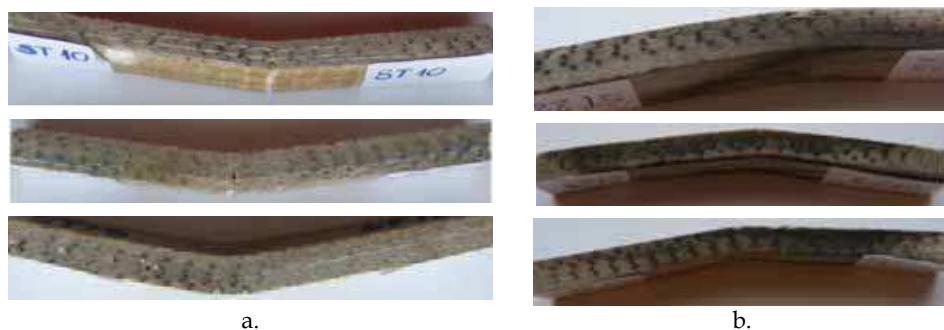

Fig. 37. Photos of the edges of the specimens made of E-glass / oak wood flour / polyester after 5853 hours of immersion in: a) water; b) seawater

Since there was no spot before immersion in water, it may assume that the oxidation of the resin could be one of the causes of the spot appearance.

Moreover, it was remarked that in case of the specimens immersed in seawater, the damaged areas located on the specimen edge are larger in case of the composite material filled with oak wood flour than in case of the other one type of composite. The greater content of the tannin in case of oak wood than in case of the fir wood, could be the cause of the greater degradation of the specimens made of the E-glass / oak wood flour / polyester composite material.

4. Conclusions and discussions

We note that the moisture absorption into the composite materials reinforced only with glass fibres, leads to the decreasing of the tensile strength, flexural strength and Young's modulus E . It was observed that the flexural modulus E of these composite materials decreases with 10 - 20 %.

Decreasing of the tensile strength is about 40 % in case of E-glass / epoxy LY 554 composite after ≈ 7000 hours of immersion in water while the decreasing of the flexural strength is 30 % after 9200 hours.

In general, it was found that the E-glass / epoxy composite analysed absorbed more water than seawater or detergent solution. The sodium chloride molecules contained in seawater (as well as sulphate), appear to be limiting the diffusion of water into the matrix material. It was observed that the detergent effect was much more pronounced than the sodium chloride effect in case of E-glass / polyester composite.

The E-glass / polyester composites (E-glass / polyester Heliopol 8431 ATX and E-glass / polyester PolyLite 440-M880) are recommended as composite materials in case of water or seawater environment.

Finally, it should remark that the absorption of water leads to the increasing of both Young's modulus E and maximum flexural normal stress σ_{\max} in case of the hybrid composite material with oak wood flour. Contrary, the absorption of water leads to the decreasing of the mechanical characteristics (Young's modulus E and strength) in case of the other one composite with fir wood flour. It follows that wood oak flour should be recommended as filler for the parts that works in water environment and that made of the hybrid composite material involved. If the humid environment contains salts fir wood flour should be used as filler because the greater content of the tannins associated to the oak wood leads to the appearance of the large dark stains over the surface of the composite.

5. Acknowledgement

This work was supported by CNCIS - UEFISCSU of Romania, project number PNII - IDEI 733 / 2008 (CNCIS - National Council of Scientific Research in Higher Education; UEFISCSU - Executive Unit for Financing Higher Education and Research).

6. References

- Adhikary, K. B.; PANG, S.; STAIGER, M. P. (2007). Long-term moisture absorption and thickness swelling behaviour of recycled thermoplastics reinforced with *Pinus radiata* sawdust. In: Chemical Engineering Journal, doi: 10.1016 /j.cej.2007.11.024.
- Adhikary, K. B.; PANG, S.; STAIGER, M. P. (2008). Dimensional stability and mechanical behaviour of wood-plastic composites based on recycled and virgin high-density polyethylene - HDPE. In: Composites Journal (Part B) 39: 807-815.
- Cerbu C. (2007). Aspects concerning the degradation of the elastic and mechanical characteristics in bending in case of the glass / polymer composite materials due to the moisture absorption, *Materiale Plastice*, ISSN 0025 / 5289, 44, nr. 2, 2007, pp.97-102;
- Cerbu C. (2005) - *Researches concerning structural optimisation of some pieces made of composite materials, loaded in environmental aggressive conditions*. Doctoral thesis. Transilvania University of Brasov
- Cerbu, C., Ciofoaia, V., Curtu I., Vişan, A. (2009). The effects of the immersion time on the mechanical behaviour in case of the composite materials reinforced with E-glass woven fabrics, *Materiale Plastice*, ISSN 0025 - 5289, 46, nr. 2, 2009, p.201;
- Cerbu, C.; Teodorescu, H. (2009). Bending behaviour of the composite materials made by recycling of the CDs and DVDs, In: Proceedings of The World Congress on Engineering WCE 2009, vol. II: p.1753-1756.
- Cerbu, C., Curtu, I. (2009). Particularities concerning the mechanical behaviour in wet environment in case of a hybrid composite material with wood flour, *Rev. ProLigno*, ISSN 1841-4737, vol. 5, Nr. 3, 2009, pp.37,
- Cerbu, C., Motoc, D., Ciofoaia, V. (2009). Advantages of the using of the poliester resin to manufacturing of the composite materials based on wood flour, *Annals of DAAAM for 2009 & Proceed. of the 20th International DAAAM Symposium "Intelligent Manufacturing & Automation: focus on Theory, Practice & Education"*, vol. 20, no. 1, 25-28th November 2009, Vienna, Austria, ISSN 1726-9679, ISBN 978-3-901509-70-4, Editor Branko Katalinic, pp.1417-1418.

- Corum, J. M., Battiste, R. L., Ruggles, M. B., Ren, W. (2001). Durability - based design criteria for a chopped-glass-fibre automotive structural composite, *Composite Science and Technology*, no. 61;
- Kamdem, D. P.; Jiang, H.; Cui, W.; Freed, J.; Matuana, L. M. (2004). Properties of wood plastic composites made of recycled HDPE and wood flour from CCA-treated wood removed from service. In: *Composites Journal (Part A)* 35: 347-355.
- Klyosov, A. A. (2007). *Wood-plastic composites*, A John Wiley & Sons, Inc. Hoboken, New Jersey, USA.
- Pomies, F., Carlson, L. A., Gillespie, J. W. (1995). Marine environmental effects on polymer matrix composites, *Composite Materials: Fatigue and Fracture*, Fifth Volume, ASTM STP 1230, R. H. Martin, Ed., American Society for Testing and Materials, Philadelphia;
- Springer, G. S. (1984). *Environmental Effects on Composite Materials*, Vol. 2, Technomic Publishing Inc., Lancaster, PA, ,;
- SR EN ISO 527 / 1,2,3. Glass fibre reinforced plastics, Determination of the tensile properties;
- SR EN ISO 178 (2001). Glass fibre reinforced plastics, Determination of flexural properties, Three point method, CEN, Bruxelles, 2001;
- SR EN ISO 62 (2008). *Plastics. Determination of water absorption*, European Committee for Standardization, Brussels.
- Takeshige, F.; Kawakami, Y.; Hayashi, M.; Ebisu S. (2007). Fatigue behavior of resin composites in aqueous environments, In: *Dental Materials* 23: 893-899.

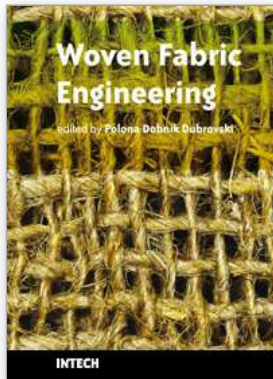

Woven Fabric Engineering

Edited by Polona Dobnik Dubrovski

ISBN 978-953-307-194-7

Hard cover, 414 pages

Publisher Sciyo

Published online 18, August, 2010

Published in print edition August, 2010

The main goal in preparing this book was to publish contemporary concepts, new discoveries and innovative ideas in the field of woven fabric engineering, predominantly for the technical applications, as well as in the field of production engineering and to stress some problems connected with the use of woven fabrics in composites. The advantage of the book *Woven Fabric Engineering* is its open access fully searchable by anyone anywhere, and in this way it provides the forum for dissemination and exchange of the latest scientific information on theoretical as well as applied areas of knowledge in the field of woven fabric engineering. It is strongly recommended for all those who are connected with woven fabrics, for industrial engineers, researchers and graduate students.

How to reference

In order to correctly reference this scholarly work, feel free to copy and paste the following:

Camelia Cerbu (2010). Effects of the Long-Time Immersion on the Mechanical Behaviour in Case of Some E-glass / Resin Composite Materials, *Woven Fabric Engineering*, Polona Dobnik Dubrovski (Ed.), ISBN: 978-953-307-194-7, InTech, Available from: <http://www.intechopen.com/books/woven-fabric-engineering/effects-of-the-long-time-immersion-on-the-mechanical-behaviour-in-case-of-some-e-glass-resin-composi>

INTECH
open science | open minds

InTech Europe

University Campus STeP Ri
Slavka Krautzeka 83/A
51000 Rijeka, Croatia
Phone: +385 (51) 770 447
Fax: +385 (51) 686 166
www.intechopen.com

InTech China

Unit 405, Office Block, Hotel Equatorial Shanghai
No.65, Yan An Road (West), Shanghai, 200040, China
中国上海市延安西路65号上海国际贵都大饭店办公楼405单元
Phone: +86-21-62489820
Fax: +86-21-62489821

© 2010 The Author(s). Licensee IntechOpen. This chapter is distributed under the terms of the [Creative Commons Attribution-NonCommercial-ShareAlike-3.0 License](#), which permits use, distribution and reproduction for non-commercial purposes, provided the original is properly cited and derivative works building on this content are distributed under the same license.