

# Sound Pressure Measurements in Urban Areas

Fernando A. N. Castro Pinto  
*Federal University of Rio de Janeiro (UFRJ)*  
*fcpinto@ufrj.br*  
*Brazil*

## 1. Introduction

The assessment of noise pollution is of prime concern in modern urban planning. Nevertheless, even in the case of the use of numerical simulations it must rely on actual measurements. In order to make reliable noise evaluations one must take into account the position of the measurement but also have a thorough knowledge of the equipment used like microphones, pre-amplifiers, and analysers. Their correct configuration is mandatory for a correct interpretation of the obtained results. The signal processing techniques ranging from detector types to the quantification of equivalent levels is discussed in this chapter.

A correct analysis of a sound event, the background noise from the vehicle traffic on streets and avenues, noise coming from industrial facilities or from air conditioning equipment, involves various parameters as sketched in Fig. 1. Not all of them can be evaluated and quantified with standard measurement equipment and techniques. Nevertheless it is possible do establish metrics for comparison of different situations and for the determination of noise thresholds in laws and regulations to protect the population from too high levels.

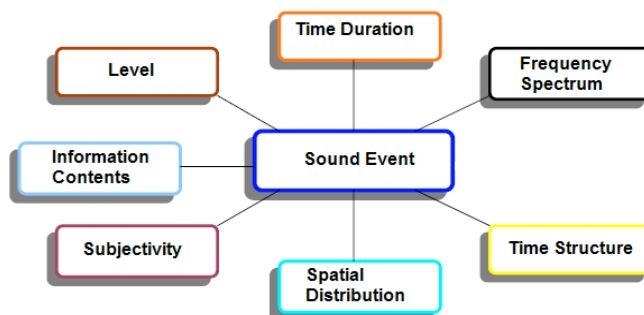

Fig. 1. Sound event parameters

## 2. Sound Pressure Level

The assessment of the noise pollution in urban areas involves the quantification of the sound exposure of the population. This task may seem at a first glance relatively simple with the

use of sound level meters, equipment which is readily available in different types. Nevertheless, in order to correctly evaluate the measurements, a thorough understanding of the acoustic phenomena involved and of the instrumentation itself is needed.

Besides the data acquisition equipment the signal processing associated with the measurements, i.e. the configuration of the sound level meter, will lead to the measurement of different parameters that are used as indicators of the noise impact.

The basic problem faced here is related to the fact that sound is a sensation caused by the pressure fluctuation occurring in our hearing system. The outer ear performs the task of gathering the pressure waves leading them to the middle ear, the middle ear in turn transforms the pressure fluctuations on the tympanum membrane into waves inside the inner ear, the cochlea, where a frequency analysis is done and the signals are then sent to a further processing in the brain.

As can be seen, a major problem arises from the engineering feasibility of measuring pressure fluctuations to actually quantify a *sensation* produced inside the brain. It is not difficult to devise the measurement of the pressure fluctuations. The microphones being a membrane which is excited by the ambient pressure transforming it into a fluctuating force over a sensing element. Ideally this sensor shall respond equally well to different kinds of fluctuations, i.e. to different frequencies of excitation.

Although desirable from the point of view of a good sensor this flat response is quite different from the actual response of our hearing system. Therefore it is necessary to adapt the results of the microphone measurements in order to get values that can be correlated to our sound sensation.

Another problem is that this sound sensation is not so simple, but is full of different aspects such as loudness, pitch, tonality, roughness, fluctuations, etc., besides being influenced by the duration of the noise event. Each of these aspects may lead to a different perception of the sound and to different impacts of the noise exposure. The definition and quantification of these different aspects of the sound sensation are studied by the field of psycho-acoustics, which is beyond the scope of this text. For the assessment of the noise pollution we shall concentrate on the sensation of loudness or volume which is mainly associated to the amplitude of the pressure fluctuations of the sound waves.

In general the human body reacts to actual *physical stimuli*, such as pressure fluctuations, light, temperature, etc., to create a sensation in a relative way. It means that the increase in the sensation is related to the relative increase in the physical stimulus. Weber and Fechner formulated this empirical law as a logarithmic function of the stimulus intensity (Schick, 2004). This intensity is in turn represented by the energy content of the stimulus. In the case of sound this energy is represented by the square of the pressure fluctuation.

One step towards the quantification of the sensation from pressure measurements is the evaluation of this energy through the definition of a mean pressure which, over a suitable time interval  $T$ , would yield the same acoustic energy of the event of interest. This is done through the RMS (Root Mean Square) value  $\overline{P}_{RMS}$  of the time varying pressure fluctuations  $p(\tau)$ , as in equation (1).

$$\overline{P}_{RMS} = \sqrt{\frac{1}{T} \int_{\tau-T}^{\tau} p(\tau)^2 d\tau} \quad (1)$$

Further, one must build the equivalent of the logarithmic function for sensations, going from an actual pressure measurement as above to a dimensionless quantification of the so called *Sound Pressure Level* or *SPL*, presented in equation (2).

$$SPL = 10 \log \left( \frac{\overline{P}_{RMS}}{P_{ref}} \right)^2 \tag{2}$$

where  $P_{ref}$  is a reference pressure value. The calculated SPL value is expressed in decibels, abbreviated dB, and the commonly, standardised, used value for  $P_{ref}$  is 20  $\mu$ Pa. The choice of a suitable time interval  $T$  for the measurement, will be addressed further in this chapter.

Another step in order to approximate the sound sensation from the sound pressure measurements is related to the frequency response of the ears. We are neither able to hear fluctuations with high frequencies, above about 20kHz, nor low frequencies, below about 30Hz. Of course the actual values are individual and may be influenced by age, diseases, and long exposure to high noise levels, among other factors. This can be translated into a sensitivity which varies with frequency. Actually the frequency dependency is also related to the loudness of the sound itself and one may construct curves representing equal sensitivity, the so called isophonic curves. Based on the pressure fluctuations of different frequencies and amplitudes that cause the same hearing sensation to a single person they are constructed from a statistical analysis of many of these measurements.

In contrast the ideal measurement microphone would show equal sensitivity to all frequencies, independently of the sound pressure level being assessed. This final step to evaluate noise consists in the *distortion* of the measured pressure signal through a filter, analogic or digital, that resembles the inverse of the sensitivity of the ears. Four such weighting filters are defined in international standards (IEC, 2002) and designated by the letters A, B, C and D. The most important for noise pollution assessment are the A and C filters, which approximate the sensitivity at levels near 40dB and 90dB respectively. Figure 2 shows the frequency characteristics of the different weighting filters.

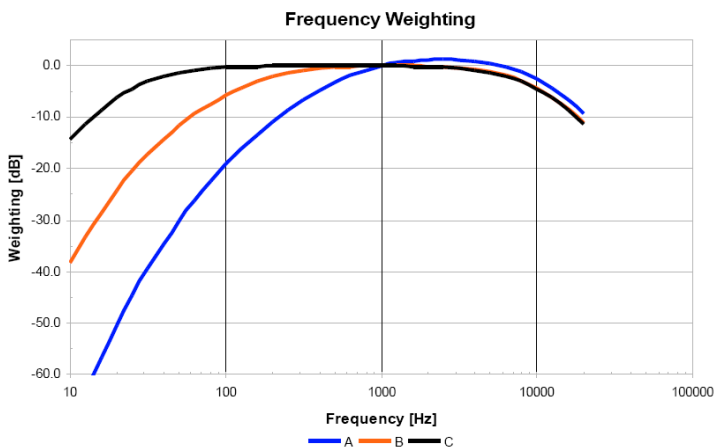

Fig. 2. Frequency characteristics of weighting filters A, B and C

Weighting curve D is mainly used to assess airport and aircraft related noise. Curve B, although interesting, since it resembles the inverse isophonic of about 70dB, a common encountered level, is seldom used. Curve C is preferred to assess impact noise and high levels. It is possible to recognise the low sensitivity for low frequencies, specially below 30Hz, and high frequencies, above 18kHz.

Nevertheless, due to the non-linear nature of the RMS calculation the filtering process, the frequency weighting, must actually be done previously, i.e. before the RMS calculation takes place. Firstly the sensitivity of the microphone is corrected to reflect the human sensitivity through the frequency weighting, after that the RMS-value is calculated and finally the level is found through the logarithmic function.

The finally obtained sound pressure level involving all described steps is expressed in dB(A), dB(B), dB(C) or dB(D) according to the filter used. In the case of no filtering it is advisable to express the measurements as dB(L), from linear or no filtering, or dB(F), from a flat response frequency filter, stating clearly that no frequency weighting was used.

It is clear from the above that the specification of a Sound Pressure Level is a mere trial to approximate the sound sensation.

Since the frequency weighting depends on the frequency spectra of the sounds being measured, without knowledge of these spectral contents of the measurements, it is not possible to convert a value expressed in dB regardless of the suffix, A, B, C, D or L (or F), into another one with a simple additive or multiplicative factor. Therefore it is sometimes advisable to measure and record the sound spectra as well.

Yet there are still deeper aspects related to the perception of loudness such as frequency and temporal masking which are not addressed by the described procedure. This can be improved through the use of other volume metrics such as the *Loudness*, defined in the ISO 532 standard (ISO, 1975), nevertheless it is still not practice in noise pollution assessment, neither is the evaluation of most other aspects of sound perception. Only the tonality is taken into account and will be discussed further in the spectral analysis of the sound, since it is related its frequency distribution.

### 3. Instrumentation

The instrumentation used to evaluate the SPL as described earlier involves the sensor, microphone, to capture the pressure fluctuations, a preamplifier to adequate the, low power, electrical signals from the microphone to a meter or a frequency analyser to perform the RMS calculation, the frequency weighting and analysis, showing the final obtained values. Often it is desirable to store the measurements, along with a time stamp, and/or to transfer them to a computer either locally or remotely. The accuracy of the whole measurement chain, and the adjustment of the microphone sensitivity, is achieved with the help of an acoustic calibrator.

#### 3.1 Microphones and Preamplifiers

The microphones used in noise pollution assessment are *measurement microphones* which shall not be confused with high quality studio or music microphones. Both types are committed to low distortion levels since the incoming sound wave should be correctly registered by both of them. No one is expecting that the singer's voice will be distorted by the microphone, nor shall the existing sound field under measurement be distorted.

Nevertheless the greatest difference between these microphones is related to the, long term, stability regarding level perception or sensitivity. If one measurement is made showing a level of say 80dB(A) and it is repeated some weeks or months later, and the same level exists, one shall expect that the result will be the same 80dB(A). This is of fundamental importance for the comparison of different situations and for a correct enforcement of laws and regulations, for they may impose some penalties for those causing high noise levels, thus high pollution impact. The studio microphone although being of good quality can be compensated for difference in its sensitivity by simply adjusting the volume control of the amplifiers or recording equipment. The levels being, in these applications, a simple matter of subjectivity. Therefore they are not suitable for actual sound pressure level measurements.

Two major types of measurement microphone are in use: condenser microphones and electret microphones (Fig. 3). Condenser microphones are more accurate, sensible, stable and exhibit higher sensitivity and shall therefore be preferred. They are of course more expensive than the electret ones, which in turn are more reliable and still possess good measurement qualities (Webster, 1999).

Condenser microphones, besides the own housing are made of a diaphragm, a backplate, and an insulator. The diaphragm and the backplate create a capacitor with air as dielectric element, often polarised from an external voltage supply provided by the meter or analyser. The sensitivity of the microphone is usually linearly related to the voltage of this external polarisation. Some models of condenser microphones have pre-polarised backplates and shall not be used with the external polarisation. The diaphragm, which is quite delicate, is protected by a removable grid. This grid is intended to be part of the sensor and is only removed for metrological calibration purposes. With the pressure fluctuations the diaphragm is excited by a fluctuating force thus varying the capacitance between diaphragm and backplate, generating the output voltage of the microphone.

Figure 4 presents a typical example of a condenser microphone.

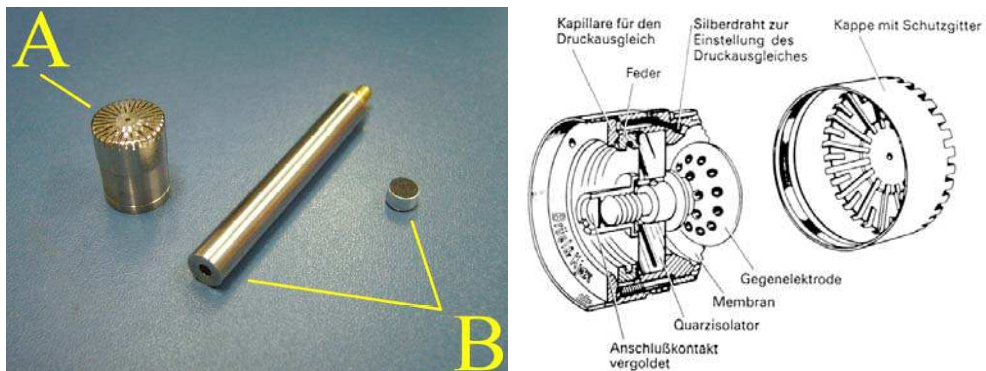

Fig. 3 and 4. Condenser (A) and electret (B) types of microphone, and condenser microphone according to Klingenberg (1991)

The microphone characteristics, including its sensitivity, are determined by its mechanical parameters such as mass, diaphragm stiffness, tension and area, internal damping, air volume of the housing, etc. Typical sensitivities of condenser microphones range from

20mV/Pa up to 100mV/Pa. A commonly used 1/2" condenser microphone will exhibit a sensitivity of about 50mV/Pa. This means that, when exposed to pressure fluctuations of 1Pa i.e. 94dB, the output of the microphone will be 50mV. Accordingly, since we are using a logarithmic dB scale for the SPL, with 114dB the output will be of 500mV and with 74dB of only 5mV. It is clear that the loudest and quietest levels capable of being measured will depend on the electrical measurement range of the meter but also on the microphone sensitivity. The quietest level is influenced by the electrical background noise on the meter, including cabling. For the commonly used microphones this level is about 15dB to 20dB. The frequency range also affected by the above mentioned parameters will usually starts about 20Hz and extend up to 20kHz, since it should follow the human ear characteristics. Since, when dealing with noise pollution in urban areas, the specified microphone shall be of *free-field* type. This kind of microphone is designed to have its frequency response compensating the presence of the microphone itself on the sound field, distorting the waves being measured. The free-field is an idealisation of a sound-field free of reflections, where the acoustic energy being measured is coming only directly from the sound source. The free-field microphones shall be pointed directly towards the sound source under investigation for they are designed to operate this way.

Condenser microphones are very sensible sensor, therefore great care shall be taken when manipulating and storing them. The protective grid shall remain in place except when it is being metrologically calibrated. This procedure consists of the verification of the sensitivity and frequency response of the microphone, done in a for this purpose accredited laboratory, and shall be repeated every two years or according to the requirements stated in local regulations, standards or applicable laws.

Electret microphones also exhibits a diaphragm and a backplate working quite with the same varying capacitance principle. However either the diaphragm or the backplate are made of a metal plated polymer which is electrically charged to create polarisation voltage. The diaphragm built in this way usually is not suited to be tensioned in order to exhibit a similar frequency response as in the case of the condenser microphone. A better construction will use the backplate as the pre-polarised surface of the capacitor, thus allowing for a better diaphragm. The sensitivities usually found in electret microphones range from 5mV/Pa to 15mV/Pa, thus being fair less sensitive than the condenser type. It means that the quietest levels that can be measured with electret microphones are higher than those from the condenser type, being of about 30dB. Two great advantages of the electret type are the reliability, the microphone itself being very robust, and the possibility of mass production, decreasing the final price of the sensor.

In both cases, with electret as well as with condenser microphones, the pressure fluctuation causes a capacitance variation. Nevertheless the electrical circuit of a meter or analyser is usually designed to measure voltage, not capacitance. In order to transform a capacitance variation in varying voltage and also to adjust the electrical impedance of the sensor to that from the meter a preamplifier is needed. Usually, the preamplifier does not affect the sensitivity of the microphone and is designed to have a flat frequency response extending beyond that of the sensor. It shall not, therefore, significantly alter the measurement characteristics of the sensor but shall allow for a better transmission of the electric signals to the sound level meter, including eventually the cabling.

For the placement of the preamplifier should be as close as possible to the sensor they are usually the mounting point of the microphone and therefore have matching dimensions

(Fig. 5). Microphones of different diameters must use different preamplifiers or specific adapters.



Fig. 5. Preamplifier for condenser (A) and electret (B) microphones (microphones attached)

The signal conditioning for the electret microphones is usually incorporated in the sound level meter and no preamplifier is usually seen, although it exists inside the meter. In some cases, where constant voltage and varying current measurement circuits are used, as in the case of IEPE interfaces, even the electret microphones are fitted with specific preamplifiers. Due to the nature of the circuitry involved in these cases only pre-polarised microphones can be used.

The complete measurement chain consists of microphone, preamplifier, cables and sound level meter. Although being part of the chain the preamplifiers are not normally required to be metrologically calibrated, only the microphones and SLM. However, during the normal calibration or verification prior to the measurements the whole chain, including the preamplifier, must be verified with an acoustic calibrator.

### 3.2 Meters and Analysers

Once the pressure fluctuations were transformed into electrical signals, through the microphone and preamplifier, a device is needed to properly execute the frequency weighting, the RMS and level calculations, displaying at the end of the process the obtained values. Since the sound level is the quantity being measured one speaks of a *Sound Level Meter (SLM)*. If the device is capable of doing some kind of frequency analysis it is in turn called *analyser*, or *spectral analyser*.

If only the instantaneous values of the detectors, slow, fast and/or impulsive are available one may speak of a simple SLM. If it is possible to configure the equipment to measure an equivalent level during some specified time interval, it is then called *Integrating Sound Level Meter* (Fig. 6).

Besides the possibility of displaying the already mentioned levels from each detector the SLM shall allow the calibration of the measurement chain, with the help of an acoustic calibrator.

An international standard, IEC61672 (IEC, 2002), establishes tolerance classes for this kind of equipment, namely types 0, 1, 2 and 3. A device of type 0 shall meet the most stringent tolerances, being more accurate than the other classes. It is mainly intended for laboratory devices operating under stable controlled conditions. Type 3 devices are seldom used for noise pollution assessment since they are not accurate enough, in general use of a type 1 or

type 2 device is enforced by law, regulations or standards. Equipment of type 1 are quite accurate and fitted with high quality condenser microphones. Type 2 in general use electret microphones and have lower cost.



Fig. 6. Integrating Sound Level Meter

Among other characteristics it is advisable to specify and use SLM with the capability of performing statistical analysis and great storage memory, allowing a deeper insight on the time variations of the sound level during a longer period of study. Integrating SLM are mandatory for the most regulations demand the measurement of an equivalent level, in dB(A),  $L_{Aeq}$ .

Very useful, when dealing with noise pollution from different kinds of sound sources in the urban environment, is the assessment of the statistical percentile levels. These values, represent the acoustic level found to be surpassed during a specified percentage of the time, from an acoustic long time assessment. For instance, if the varying levels during a measurement are above a certain value, in decibels, during ten percent of the time, this value is called the Ln10, accordingly the value for which the levels are over for half of the time being considered (50%) is called Ln50 and so on.

If its difficult to measure the background noise for the sources cannot be turned off, the Ln90 can be used as an estimate. During noise pollution surveys it is usual to establish at least the percentile levels Ln10, Ln50, Ln90. The difference among them is related to the variations found in the noise impact. If one is dealing with a source operating continuously and in steady state, like an industrial equipment for instance, the percentile levels would be close to each other, a few dB, for the level itself will not vary along the measurement. With traffic noise or noise from entertainment activities for instance one will face spread percentile levels for the sound source varies with time. The long term time structure of the noise can be assessed by the percentile levels. They need to be determined from a continuous statistical assessment during the measurement and is automatically done by the sound level meters or analysers capable of doing this kind of analysis. Figures 7 and 8 shows two different situations where the Fast level is shown together with percentiles Ln10, Ln50 and Ln90, please note the different time scales in the figures. One can easily see that the difference between the percentile levels is quite smaller for the steady state noise from a turbine than in a sport stadium with people cheering.



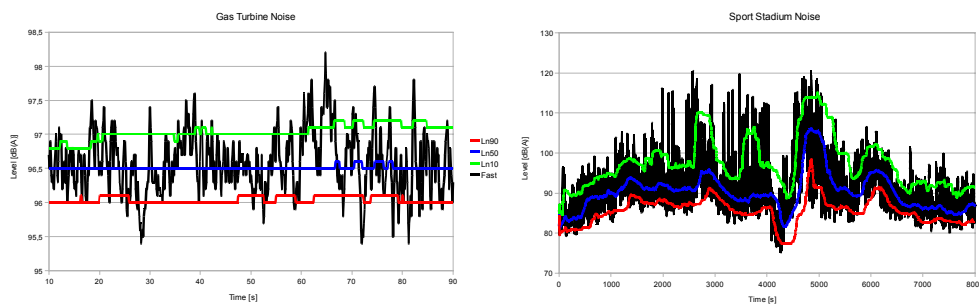

Fig. 7 and 8. Time evolution of percentile Ln levels from a running gas turbine, and time evolution of percentile Ln levels from noise in a sports arena

When complex situations are faced an efficient design of mitigation measures must take into account the nature of the sound field involved. This may lead to the necessity of determining the distribution of the sound energy among the different frequencies of the audible spectrum, in order to specify the correct absorptive materials or isolation. This is accomplished by a spectral analyser using variable width, broad band, frequency filters like the octave filters or third octave filters.

Octave filters were developed based on the human ear characteristics which tends to render similar sounds with doubling frequency ratios. A sound with 440Hz or with 880Hz are quite different from each other in the sense of frequency of the pressure fluctuations, nevertheless, both are recognised by the listener as being the same musical note. An octave is thus a frequency interval corresponding to a doubling, or halving, of some basis frequency. For the octave filters, which are standardised, the basis frequency is 1000Hz, used as the centre frequency of one of the filters. As one can easily see, the bandwidth of the filters must grow with growing frequency, obeying a power law, as in equation (3).

$$f_{i+n} = f_i \times 2^n \tag{3}$$

where  $f$  is the basis frequency of 1000Hz and  $i$  varies from 1 to 11,  $f_i$  varying from approximately 16Hz to 16kHz.

The initial, center, and end frequencies of the octave filters are shown on Table 1. The power law is however slightly modified to round up some frequencies.

The human ear performs a frequency analysis in the inner ear. Due to the spatial characteristics of the cochlea the frequency evaluation takes place in a way resembling filters obeying a power law similar to equation (3), as in equation (4).

$$f_{i+n} = f_i \times 2^{\frac{n}{3}} \tag{4}$$

where  $f_{20}$  is the basis frequency of 1000Hz and  $i$  varies from 1 to 33,  $f_i$  varying from approximately 12.5Hz to 20kHz.

Since the exponent is now 1/3 of the exponent from the octaves these filters are known as third octave filters. One octave corresponds to three, sequential, third octave filters. Their

initial, center, and end frequencies are also shown on Table 1, and are in the same way rounded. It is a rather good approximation of the behaviour of the inner ear, specially for frequencies above 150Hz. Below this frequency the bandwidth of the inner ear filtering is broader than the first third octave filters.

<i>Octave</i>			<i>Third Octave</i>		
<i>Initial</i>	<i>Center</i>	<i>End</i>	<i>Initial</i>	<i>Center</i>	<i>End</i>
11	16	22	11,2	12,5	14,1
			14,1	16	17,8
			17,8	20	22,4
			22,4	25	28,2
22	31,5	44	28,2	31,5	35,5
			35,5	40	44,7
			44,7	50	56,2
44	63	88	56,2	63	70,8
			70,8	80	89,1
			89,1	100	112
88	125	177	112	125	141
			141	160	178
			178	200	224
177	250	355	224	250	282
			282	315	355
			355	400	447
355	500	710	447	500	562
			562	630	708
			708	800	891
710	1000	1420	891	1000	1122
			1122	1250	1413
			1413	1600	1778
1420	2000	2840	1778	2000	2239
			2239	2500	2818
			2818	3150	3548
2840	4000	5680	3548	4000	4467
			4467	5000	5623
			5623	6300	7079
5680	8000	11360	7079	8000	8913
			8913	1000	11220
			11220	12220	14130
11360	16000	22720	14130	16000	17780
			17780	20000	22390

Table 1. Initial, Center and End frequencies from octave and third octave filters in Hz

The frequency analysis consists in the separation of the energy contents of the sound signal into distinct parts, between the initial and end frequencies of each filter. The sum of the energies of all filters will correspond to the energy of the whole signal. The frequency characteristics of the octave and third octave filters are standardised by IEC 1260 (IEC, 1995). Once the energy is divided among the filters the same procedure is done to obtain the corresponding sound pressure levels in each frequency, including eventually the frequency weighting. From the obtained spectra, we can approximately convert from dB to dB(A) or any other weighting by just adding the values in dB shown in Fig. 2 for each weighting found at the corresponding center frequency of each filter. Please note that the majority of the values are negative, thus reducing the corresponding levels. From weighted spectra, we can find the approximate flat or linear spectra by just doing the subtraction.

As noted before the bandwidth of the third octave filters is quite narrow in the low frequency range but rather broad in higher frequencies. If there is a need to determine precisely the frequency contents of the sound, for instance to correctly identify a source or to optimise the acoustic treatment another possibility is the use of constant bandwidth filters implemented through Fast Fourier Transform (FFT) algorithms. The mathematics of the FFT is beyond the scope of this chapter but consists on the use of the properties of the Fourier transforms, actually of the Fourier series, to split the energy of the signal among several bins each with the same bandwidth, over the whole frequency range.

Since it is accomplished by a mathematical algorithm, the FFT analyser requires the digitalisation of the signal and a computer to perform the calculations. Of course the frequency analyser itself is a dedicated computer. Modern systems tend to split the functions requiring a device for the data acquisition and digitalisation and a computer, normally a laptop, with software to perform the calculations and display. The same procedure for weighted spectra conversion can be used here.

In the case of noise pollution assessment, most regulations and standards foresee a kind of penalty for the case of the presence of pure tones in the sound. This is due to the quite annoying characteristics of this kind of noise. For two distinct situations with the same overall sound pressure level, one with broad band noise, the other with the presence of a prominent pure tone, even in the context of a broad band noise, the human ear tends to regard the former as being more annoying. In order to detect and document the tonality of the noise its spectral characteristics is taken into account. Normally if any of the filters, in a third octave spectrum, or any of the bins in a FFT-analysis exhibits a level which is 5dB higher than those of its neighbours, filters or bins, the noise may be regarded as being tonal.

For more complete analysis, specially for long term monitoring, these functionalities can be combined with data transmission on a monitoring station. They may be installed on a fixed position, measuring and storing data which are transmitted to a central through, telephone lines, cell phone technology or even wireless internet connections. Different protocols are used for this data transmission, mostly proprietary protocols from the equipment producer. Monitoring stations are normally offered with a complete package including software for the data transmission, and a database to store and analyse the obtained levels.

Figure 9 presents the results from different analysis of the same signal.

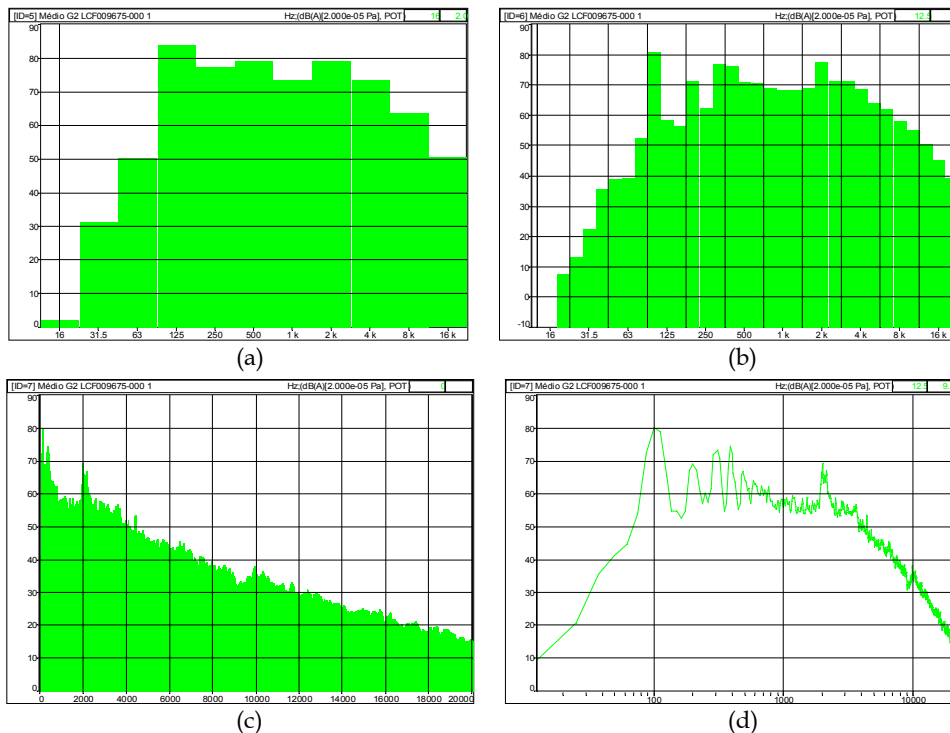

Fig. 9. Different analysis of the same signal (Level [dB] x Frequency [Hz]): (a) Octave, (b) Third Octave, (c) FFT Linear freq. Axis, and (d) FFT Logarithmic freq. Axis

### 3.3 Choice of Detector and Time Interval

Usually, during a noise pollution assessment, one will deal with time varying sound pressure levels. In order to evaluate the measurements it must be distinguished among equivalent levels over a time period and the instantaneous levels. For the sake of allowing a comparison between different measurements, done with different equipment a set of detectors were defined in the standard IEC 61672 (IEC, 2002) which will provide the instantaneous level of the measurement. They reflect the behaviour of the acoustic signal in different time scales, from 1 second to a few milliseconds. Although they may be actually regarded as equivalent levels for this time interval, calculated according to equation (1) with the corresponding value for  $T$  from the Table 2, the duration is quite small when compared with the time scale of a general assessment of noise that they may be considered as instantaneous. Table 2 shows the different standardised detectors and their time scales.

<i>Detector</i>	<i>Averaging time</i>	<i>Use</i>
Slow	1 s	Outdoor noise
Fast	0.125 s (1/8 s)	Outdoor and indoor noise
Impulse	0.032 s with longer decay time	Short duration impulsive events
Peak	Instantaneous	Impulsive noise

Table 2. Sound level meter detectors

If a graphic is plotted with these values, we will have the time history of the noise being measured. Of course the Fast detector will better follow the fast variations of the signal. Actually the regulation or standards for noise assessment being followed will determine the kind of detector to be used. The Impulsive detector is more appropriate for the evaluation of impact noise, as well as the Peak detector. The Slow and Fast are more used in urban noise assessment. Figure 10 shows the time history of the same acoustic event measured with different detectors.

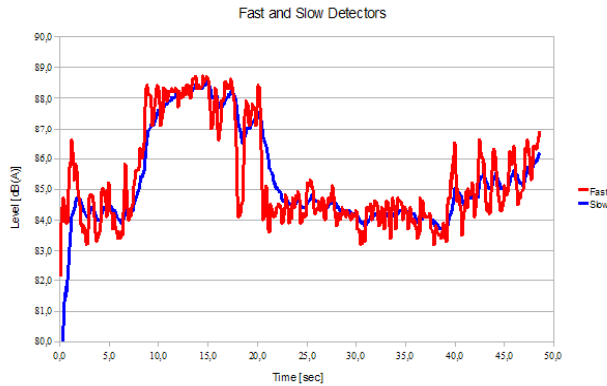

Fig. 10. Time history of a signal with different detectors

With the advent of the integrating sound level meters the parameter for a long term evaluation of urban noise changed for the equivalent level  $Leq$ , in most cases with A-weighting the  $LAeq$ . The evaluation is done again according to equation (2) but the choice of the averaging time  $T$  shall reflect the behaviour of the noise being assessed. The averaging time must thus be chosen in order to reflect the main variations of the sound, reflecting a representative portion of its overall behaviour. In the case of a traffic noise for instance, it must cover periods of red lights as well as periods with normal traffic. A time span of 5 minutes is normally a good choice. For industrial noise, with equipment running continuously and in steady-state about 1 minute may be a good choice. In the same way one can build a time history of the sound with  $Leq$  levels or also build a time evolution of the  $Leq$  parameter allowing the time  $T$  to continuously increase until it eventually reach a constant level. This will correspond to a general average of the acoustic energy over this period. Figure 11 shows the time history of 5 minutes  $LAeq$  from traffic noise over a whole day in two different locations. For comparison, the instantaneous Fast levels are also shown.

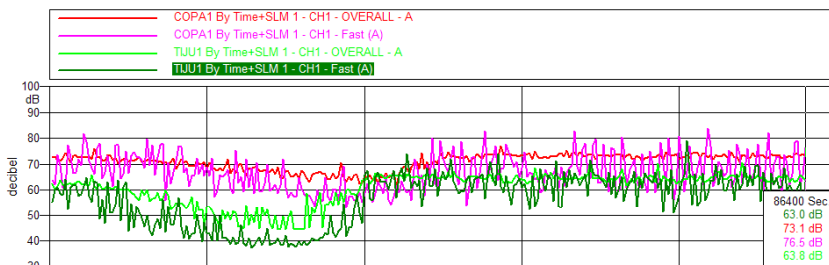

Fig. 11. Time history from Traffic noise in a 24h period –  $LAeq$  5 min. and Fast

Of course when stating a *Leq* level, we must also mention the time period used for its determination.

### 3.4 Acoustic Calibrators

The primary objective of the acoustic calibrator is to provide a reliable reference of frequency and amplitude for the pressure fluctuation. Thus it allows the quick verification of the quality and accuracy of the measurement chain, from the microphone to the meter or analyser (IEC, 2003). It consists of an equipment capable of generating a simple harmonic acoustic noise signal, with known amplitude and frequency.

Usually the amplitude values correspond to either 94dB or 114dB, 1Pa or 10Pa respectively. The use of higher values is related to a better stability of the electro-mechanical mechanism when compared to the generation of a relatively small pressure of 1 Pa.

The frequencies most commonly found in calibrators are 250Hz and 1kHz. Whenever possible use shall be made of a frequency of 1kHz. Since every standard weighting filter, from A to D, do not impose a correction factor at 1kHz, the imposed amplitude of the harmonic sound wave value is expressed as the same SPL, either 94dB or 114dB depending on the choice, in whatever filter chosen, and even without weighting (dB(F) or (L)). This facilitates the setup of the measuring equipment, reducing the chance of an operator's error. Since the conversion of pressure fluctuation into electric signals is mainly determined by the microphone sensitivity, the measurement equipment must be properly set to correctly convert the voltage received to pressure. This can be achieved by exposing the microphone to the known pressure generated at the calibrator output, setting up the measurement either to the global sound pressure value or to the specific frequency of the calibrator, and observing the instruments reading. Using its setup options the obtained value shall be corrected to correspond to the calibrator's level, thus assuring the accuracy of the measurement chain. This procedure shall be repeated before and after each measurement set and is of course mandatory after a microphone replacement, for its sensitivity will likely be different from the previous one.

After the measurement set is finished, the calibrator shall be used again to verify if any changes have occurred in this period. The difference obtained between the calibrator level and the reading at the end of the measurement set is an indicator of the smaller bias error of the values obtained. Of course other factors affecting the measurement will still need to be added upon this bias.

Care should be taken when positioning the microphone in the calibrator's opening for it must fit properly in place. Otherwise the imposed pressure on the microphone will not correspond to the expected level. The volume of cavity formed at the calibrator, with the microphone closing the opening, is extremely important, therefore.

For different standardised microphone diameters one may find suitable adapters for the calibrator's opening.

## 4. Positioning

A very important issue, of course, is related to the place where the measurement takes place. Sound pressure levels are consequence of an existing sound field build up by the sound waves and their interactions with the environment. Reflection and diffraction are very important factors to be considered as well as the eventual interference between sound waves

coming from different sources or reflections. Much like a temperature field, it is hotter near a heat source such as an oven than far away from it, the sound pressure level may vary from place to place. Therefore the actual position where the measurement is being made will influence the result.

In the urban noise assessment of primary concern is the position where the population is exposed to the pollution. Although a measurement near the sound source may be very useful to characterise this source the population may be exposed to different levels in different places. For instance, for a source like traffic noise, there may be remarkable differences between levels measured at the side walk, at the first floor in a building, at the highest floor in the building and even in windows facing directly to the street or facing the back of the building. Thus together with the sound pressure level one must also report the exact location where it was obtained. Commonly used measurement heights are 1.2m to 1.5m, corresponding more or less to the ear level and 4.0m in urban surveys, avoiding being too close to the traffic noise source. The regulations or standards followed shall indicate the measurement height when applicable.

A different situation arises when dealing with specific complaints. In these cases preference should be given to measurements in the actual places where the complaints are made. Some regulations however (ABNT, 2000, and City of Rio de Janeiro, 1978, 1985, 2002) allows the measurements to be done from a specified distance from the sound source. Sound source in this case, from the point of view of urban legislation, may be regarded as being the terrain or property where the sound is being generated, where the emission comes from. It is not the equipment, machine, sound system or whatsoever which is regarded as source since one will not have, in general, permission to enter the property to evaluate the noise. Therefore the property itself is considered as source.

When measuring inside of rooms care should be taken with the eventual presence of standing waves due to resonance. Usually at least three measurements are done and their average value is taken as the result. Positions close to walls or furniture must be avoided, with a distance of at least 1m. The values measured will also differ if measured directly on the facade, or with open or closed windows. The actual position must be correctly reported to allow a further verification or comparison to other evaluated levels.

Avoided in any case must be measurements too close, less than 1m, to reflective surfaces of any kind such as walls, vehicles, trees, etc... Barriers shall also be avoided, including here even the very presence of the operator of the sound level meter in the sound field.

No measurement shall be done under rain conditions, for the rain noise in general is not considered in the allowable limits and the high humidity is dangerous to the measurement equipment. If the wind speed is above 5m/s the measurements may be affected by the wind noise itself, generated by the presence of the microphone in the air flow. Without measurement there will be no flow disturbance and the wind noise measured will not exist. Therefore measurements under these conditions are not reliable. In the presence of wind, with lower speeds, a suitable wind protection, windscreen, must be used to reduce the flow noise induced at the microphone diaphragm.

## 5. Conclusion

The correct assessment of noise levels starts with the measurement of the physical stimulus pressure fluctuations in order to quantify the sensation caused, the sound. In order to

perform actual measurements which may be useful to enforce the application of laws and regulations a thorough knowledge of the characteristics of the involved sensors and equipment as well as the correct choice of configuration parameters. Among others a suitable time detector, frequency weighting filter, correct calibration and bandwidth of the spectral analysis are of primary importance. These aspects, together with the positioning of the microphones and the evaluation of the commonly used metrics were discussed to help the choice of measurement configuration in order to understand the environmental impact of noise pollution in urban centres.

## 6. References

- ABNT - Associação Brasileira de Normas Técnicas (2000). *NBR 10151/2000 Acústica - Avaliação do ruído em áreas habitadas, visando o conforto da comunidade - Procedimento*, Rio de Janeiro, Brazil
- City of Rio de Janeiro (1978). *Decree #1,601 from June 21st (1978)*, Diário Oficial do Município do Rio de Janeiro, Brazil
- City of Rio de Janeiro (1985). *Decree #5,412 from October 24th (1985)*, Diário Oficial do Município do Rio de Janeiro, Brazil
- City of Rio de Janeiro (2002). *Resolution #198 from February 22nd 2002 of the environmental board of the city*, Diário Oficial do Município do Rio de Janeiro, Brazil
- IEC (1995). *IEC 1260 Electroacoustics - Octave-band and fractional-octave-band filters*, International Electrotechnical Commission, Genève, Switzerland
- IEC (2002). *IEC 61672-1 Electroacoustics - Sound Level Meters Part 1 Specifications*, International Electrotechnical Commission, Genève, Switzerland
- IEC (2003). *IEC 60942 Electroacoustics - Sound Calibrators*, International Electrotechnical Commission, Genève, Switzerland
- ISO (1975). *ISO 532 Method for Calculating Loudness Level*, International Organization for Standardization
- Klingenberg, H. (1991). *Automobilmeßtechnik Band A: Akustik*, Springer Verlag, Berlin
- Schick, A. (2004). History of psychoacoustics, In: *Proceedings of 18th International Congress on Acoustics (ICA)*, Kyoto Acoustical Science and Technology for Quality of Life, Vol. V, pp. 3759-3762
- Webster, J.G. (1999). *Measurement, Instrumentation, and Sensors Handbook CRCnetBASE*, CD-ROM, CRC-Press, Boca Raton, USA



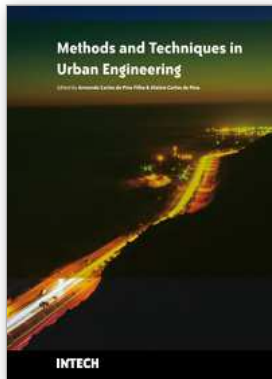

## **Methods and Techniques in Urban Engineering**

Edited by Armando Carlos de Pina Filho and Aloisio Carlos de Pina

ISBN 978-953-307-096-4

Hard cover, 262 pages

**Publisher** InTech

**Published online** 01, May, 2010

**Published in print edition** May, 2010

A series of urban problems such as dwelling deficit, infrastructure problems, inefficient services, environmental pollution, etc. can be observed in many countries. Urban Engineering searches solutions for these problems using a conjoined system of planning, management and technology. A great deal of research is devoted to application of instruments, methodologies and tools for monitoring and acquisition of data, based on the factual experience and computational modeling. The objective of the book was to present works related to urban automation, geographic information systems (GIS), analysis, monitoring and management of urban noise, floods and transports, information technology applied to the cities, tools for urban simulation, social monitoring and control of urban policies, sustainability, etc., demonstrating methods and techniques applied in Urban Engineering. Considering all the interesting information presented, the book can offer some aid in creating new research, as well as incite the interest of people for this area of study, since Urban Engineering is fundamental for city development.

### **How to reference**

In order to correctly reference this scholarly work, feel free to copy and paste the following:

Fernando A. N. Castro Pinto (2010). Sound Pressure Measurements in Urban Areas, Methods and Techniques in Urban Engineering, Armando Carlos de Pina Filho and Aloisio Carlos de Pina (Ed.), ISBN: 978-953-307-096-4, InTech, Available from: <http://www.intechopen.com/books/methods-and-techniques-in-urban-engineering/sound-pressure-measurements-in-urban-areas>

# **INTECH**

open science | open minds

### **InTech Europe**

University Campus STeP Ri  
Slavka Krautzeka 83/A  
51000 Rijeka, Croatia  
Phone: +385 (51) 770 447  
Fax: +385 (51) 686 166  
[www.intechopen.com](http://www.intechopen.com)

### **InTech China**

Unit 405, Office Block, Hotel Equatorial Shanghai  
No.65, Yan An Road (West), Shanghai, 200040, China  
中国上海市延安西路65号上海国际贵都大饭店办公楼405单元  
Phone: +86-21-62489820  
Fax: +86-21-62489821

© 2010 The Author(s). Licensee IntechOpen. This chapter is distributed under the terms of the [Creative Commons Attribution-NonCommercial-ShareAlike-3.0 License](#), which permits use, distribution and reproduction for non-commercial purposes, provided the original is properly cited and derivative works building on this content are distributed under the same license.