

# Vibration Based Control for Flexible Link Manipulator

Tamer Mansour, Atsushi Konno  
and Masaru Uchiyama  
*Tohoku University*  
*Japan*

## 1. Introduction

Robotic manipulators are widely used to help in dangerous, monotonous, and tedious jobs. Most of the existing robotic manipulators are designed and built in a manner to maximize stiffness in an attempt to minimize the vibration of the end-effectors. This high stiffness is achieved by using heavy material and bulky design. Hence, the existing heavy rigid manipulators are shown to be inefficient in terms of power consumption or speed with respect to the operating payload. Also, the operation of high precision robots is severely limited by their dynamic deflection, which persists for a period of time after a move is completed. The settling time required for this residual vibration delays subsequent operations, thus conflicting with the demand of increased productivity. These conflicting requirements between high speed and high accuracy have rendered the robotic assembly task a challenging research problem. In addition, many industrial manipulators face the problem of arm vibrations during high-speed motion. In order to improve industrial productivity, it is required to reduce the weight of the arms and/or to increase their speed of operation. For these purposes, it is very desirable to build flexible robotic manipulators. Compared to the conventional heavy and bulky robots, flexible link manipulators have the potential advantage of lower cost, larger work volume, higher operational speed, greater payload-to-manipulator weight ratio, smaller actuators, lower energy consumption, better manoeuvrability, better transportability and safer operation due to reduced inertia. However, the major drawback of these robots is the inaccuracy of the end effectors due to low stiffness. Due to the importance and usefulness of these robots, researchers are nowadays engaged in the investigation of control of flexible manipulator. The issue of tip position control for flexible link manipulator has gained a lot of attention due to the great benefits, which can be achieved by changing the traditional rigid robots with flexible ones. Then, by measuring the elastic deformations of the link and using a more sophisticated control algorithm, the endpoint of the robot can be controlled with a relatively high degree of precision with minimal vibration. Using the vibration signal that is from the motion of the flexible links robot is one of the important methods used in controlling the tip position of the single-link arms. Compared with the common methods for controlling the base of the flexible arm the vibration feedback can improve the use of the flexible-link robot systems.

The control of a flexible robot arm has attracted many researchers either to design advanced and intelligent controllers or to use smart actuators in order to achieve a high positioning accuracy at the end of the arm. An initial experiment on the control of a single-link flexible robot moving in a plane was done by (Cannon & Schmitz, 1984). After then many researches have been done in all topics related to the control of flexible robot arms. Some researches focus on the modelling of the flexible arm such as (Zhu & Mote, 1997); (Kariz & Heppler, 2000). (Ge et al., 1997); (Ge et al., 1998) uses the finite element method to model flexible arms. The use of smart material and piezoelectric actuators in suppressing the vibration for a flexible robot has been investigated by (Tawfeic et al., 1997). (Lee et al., 1988) proposed PDS (proportional-derivative-strain) control for vibration suppression of multi-flexible-link manipulators and analyzed the Lyapunov stability of the PDS control while (Matsuno & Hayashi, 2000) applied the PDS control to a cooperative task of two one-link flexible arms. They aimed to accomplish the desired grasping force for a common rigid object and the vibration absorption of the flexible arms. Control policy had attracted (Menq & Xia, 1993) to investigate the use of classical control for the single-link flexible arm. The optimal control of the flexible link is highlighted by (Rai & Asada, 1995) while (Etxebarria et al., 2005) have proposed a robust control scheme for flexible link robotic manipulators.

The motivation for this research is to find a simple controller, which can be able to achieve final accurate tip position for the flexible arm and at the same time reduce resulting vibration. The use of the deflection signal or its derivatives in the feedback is one of the effective methods used in controlling the vibration of the tip position. A modified PID (MPID) control that uses the rate of change of the tip deflection is investigated in this chapter.

In this chapter, a Modified PID control (MPID) is proposed to control flexible link manipulator. The MPID control depends mainly on vibration feedback to improve the response of the flexible arm without the massive need of measurements. First, we give a brief introduction about the experimental set-up then the dynamic model of the system is driven. A detailed of the controller design is shown and the analysis of this controller is highlighted. The stability of the system is checked with the proposed controller. A case study for a single link flexible manipulator is chosen to verify the proposed controller. Simulation results are exposed for the system using the MPID to suppress the vibration. Finally, the experimental results for the response of the flexible manipulator are shown. A concluding summary is ending the chapter.

Unlike other research (Ge et al., 1998), the effect of static deformation is taken into consideration when evaluating the effect of the vibration on the control signal. As this control signal will drive the flexible manipulator, residual strain due to material defect and/or static deformation may lead to inaccurate movement. In addition to that, an experimental verification has been done in parallel with a simulation study to evaluate the performance of the MPID control. Using the rate of deflection at the tip of flexible manipulator as an indication for the vibration of the tip can remove successfully the effect of static deformation that may appears in the generated control signal.

The main contribution point with this controller is the usage of the rate of deflection at the tip as an indication of the vibration. The controller succeeds to remove the quasi-static component in the strain instead of using high-pass filter, which is used in general. However, a high-pass filter may bring a phase shift, which may cause the instability. The MPID

controller uses rate of deflection; therefore, neither quasi-static strains due to gravity nor residual strains in the material bring a problem.

## 2. Experimental setup

In this section, the details of the experimental flexible robot system are presented. As shown in Fig. 1, the flexible robot consists of a motor/actuator, an arm of length  $l$  and an end-point payload  $M_t$ . All the three elements are related to each other through the shear force and the bending moment. The motor torque  $T$  drives the whole system. The flexural rigidity  $EI$  and the mass per unit length  $\rho$  of the arm are assumed uniform along the length of the arm. A motor armature and gearbox are described by an equivalent moment of inertia  $I_h$  at the hub. A payload  $M_t$  is mounted at the tip of the arm. The variable  $\delta(x, t)$  is the deflection of the arm at a point located a distance  $x$  from the hub, measured relative to the non-deformed position of the arm.  $\theta$  is the rotary angle of the arm from its reference position. The geometry of the single-link flexible robot is shown in Fig. 1.

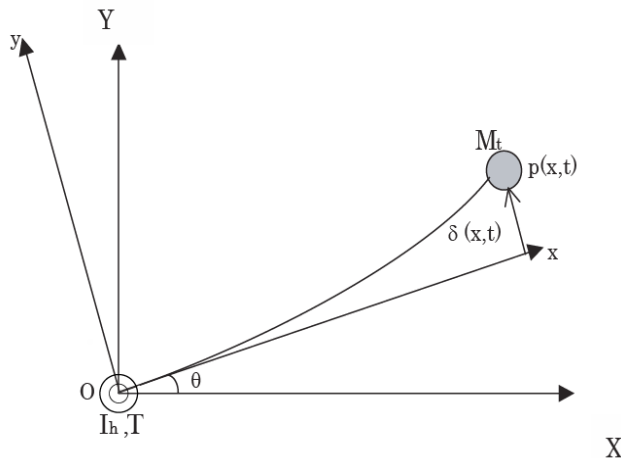

Fig. 1. Flexible arm system.

The experimental apparatus shown in Fig. 2 consists of a flexible arm, an actuator and sensors for tip and hub. An aluminum thin plate is used for the arm. The payload at the tip of the arm is detachable. The base end of the arm is clamped onto the hub that is driven by a DC permanent magnet servomotor, which is controlled by a PWM servo amplifier through a reduction gearbox. A tachometer is used to measure the rotary velocity of the joint. The flexible arm can freely bend in the horizontal plane but not in the vertical plane nor in torsion in order to eliminate the gravitational effects. Strain gauges are used to measure the strain at the base of the arm, which is an indication for the deflection of the tip. A measuring circuit with an amplifier is applied to get the value of the deflection. A/D converter is used to convert the analog signals into digital signals through an interface card. The hub position is measured using a rotary encoder. A digital controller is used through PC computer. The

measurement instruments used for measuring the joint angle, joint velocity and the deflection is shown in Fig. 2.



Fig. 2. The experimental setup.

A program written in C language is used for the interfacing and controlling processes. In addition, a digital low pass filter based on Hamming window is used to eliminate the noise from the deflection-measured signal. The physical parameters of the system are shown in Table 1.

Parameter	Values
$l \times b \times h$ (Arm dim.)	$0.5 \times 0.003 \times 0.05$ m
$\rho$ (Uniform mass/unit length)	0.403 kg/m
$EI$ (Flexural rigidity)	7.85 Nm <sup>2</sup>
$M_t$ (Tip payload)	0.0, 0.25, 0.5 kg
$K_1$ (Motor amplifier gain)	4.8 V/V
$K_2$ (Motor torque const.)	0.11 Nm/A
$K_3$ (Back E.M.F const.)	0.117 V/rpm
$G$ (Gear ratio)	80
$L$ (Inductance)	1.4 Mh
$R$ (Armature resistance)	0.4 .
$b$ (Viscous friction coeff.)	0.003 Nm/(rad/s)
$J$ (Inertia for the motor)	$3.48 \times 10^{-4}$ kgm <sup>2</sup>

Table 1. Physical parameters of the system.

The mathematical equations, which represent the motor dynamics and the reduction gearbox, are expressed as:

$$v_a(t) = K_1 u(t), \quad (1)$$

where  $u(t)$  is the control signal generated from the controller and  $v_a(t)$  is the armature voltage.

As the speed of a armature-controlled dc servo motor is controlled by the armature voltage  $v_a(t)$  which is the output from the amplifier. The differential equation for the armature circuit is

$$v_a(t) = R i_a(t) + L \frac{d i_a(t)}{d t} + v_b(t), \quad (2)$$

where  $i_a(t)$  is the armature current and  $v_b(t)$  is the back EMF voltage.

For a constant flux, the back EMF voltage  $v_b(t)$  is directly proportional to the angular velocity  $d\theta/dt$ , or

$$v_b(t) = K_3 \frac{d\theta(t)}{d t}. \quad (3)$$

The equations for torque equilibrium are

$$T_m(t) = J_o \frac{d^2\theta(t)}{d t^2} + b_o \frac{d\theta(t)}{d t}, \quad (4)$$

$$T_m(t) = K_2 i_a(t), \quad (5)$$

where  $T_m(t)$  is the output torque from the motor and  $J_o, b_o$  are the inertia and viscous friction of the combination of the motor, load, and gear referred to the motor shaft respectively.

### 3. Dynamic modelling

In this section, the mathematical model of the flexible link manipulator is driven in order to be used in the simulation program. First, we construct a simple block diagram to explain the complete system. The block diagram, which represents the system of the single-link flexible robot, is illustrated in Fig. 3. As shown previously in section 2 the mathematical equation of the actuator is driven starting from the output signal of the controller  $u(t)$  to the output from the motor. Equation (6) gives the relation between the motor torque and arm torque as follows:

$$T_{arm}(t) = G T_m(t), \quad (6)$$

where  $T_m(t)$  is the motor torque and  $T_{arm}(t)$  is the arm torque .

Three measurements are available on the experiment, the hub rotational angle  $\theta(t)$  is measured using the rotary encoder, the tip deflection  $\delta(l, t)$  is calculated from the strain at the base of the arm assuming the first vibration mode shape, and the velocity of the hub

$d\theta/dt$  is measured by the tachometer.

From the analysis of the single-link flexible arm in the experimental work, a continuous clamped-free beam approximates the flexible link. The flexible arm shown in Fig. 1 is rotating in the horizontal plane and the effect of gravity is not taken into consideration. Frame  $O-XY$  is the fixed base frame and frame  $O-xy$  is the local frame rotating with the hub. The deflection  $\delta(x, t)$  is assumed to be small compared to the length of the arm. Let  $p(x, t)$  represents the tangential position of a point on the flexible arm and with respect to the frame  $O-XY$ . From the assumption of the deflection of the flexible arm, the equation that describes the position is given by:

$$p(x, t) = x\theta(t) + \delta(x, t), \tag{7}$$

where  $p(x, t)$  is the position of a point at distance  $x$  from the base of the arm at any time and  $\delta(x, t)$  is the distance from the local rotating frame  $O-xy$  to the arm for a point at distance  $x$  from the base of the arm at any time.

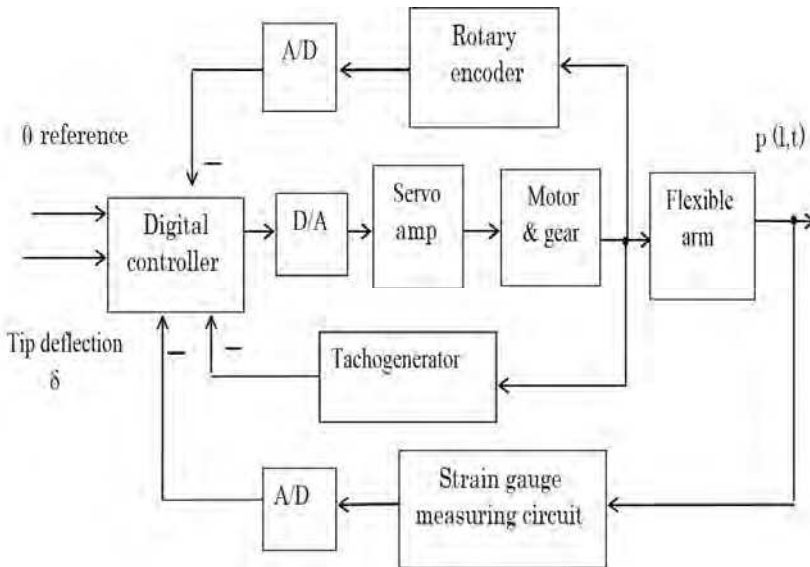

Fig. 3. Block diagram for single-link manipulator.

The flexible arm is modelled as Euler-Bernoulli beam under the assumption of simple beam theory, which is valid when the ratio between beam's length and its height is relatively large ( $>10$ ) and if the beam does not become too wrinkled because of flexure. Also, it is assumed that the beam has a uniform cross-sectional area and constant characteristics. If the flexible beam is treated as a simple cantilever as shown in Fig. 4. The deflection at the free end of the beam can be estimated as

$$\delta(l, t) = \frac{Fl^3}{3EI}, \tag{8}$$

where  $F$  is the force at the free end and  $EI$  is the uniform flexural rigidity of the beam. Then, the Euler-Bernoulli equation for the link is given as follows :

$$EI \frac{\partial^4 p(x,t)}{\partial x^4} + \rho \frac{\partial^2 p(x,t)}{\partial t^2} = 0. \tag{9}$$

Substituting equation (7) into (9), the following equation is obtained:

$$EI \frac{\partial^4 \delta(x,t)}{\partial x^4} + \rho \frac{\partial^2 \delta(x,t)}{\partial t^2} = -\rho x \ddot{\theta}(t) \tag{10}$$

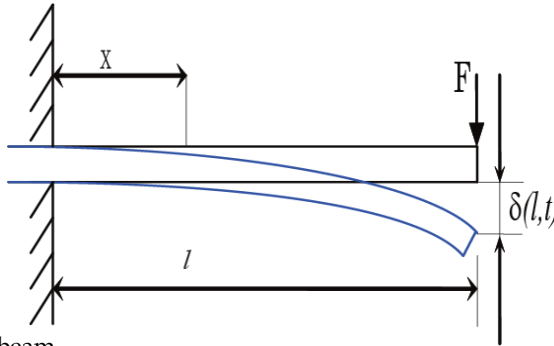

Fig. 4. Cantilever beam.

As the flexible arm is clamped at its base, both the deflection and the slope of the deflection curve must be zero at the clamped end (Meirovitch, 1967). Those conditions are represented by equations (11) and (12) respectively. Equation (13) presents the bending moment at the free end that is equal zero. Finally, if we make force balance at the tip of the flexible manipulator we can get equation (14). The boundary conditions can be summarized as follow:

$$\delta(x,t)|_{x=0} = 0, \tag{11}$$

$$\frac{\partial \delta(x,t)}{\partial x} |_{x=0} = 0, \tag{12}$$

$$EI \frac{\partial^2 \delta(x,t)}{\partial x^2} |_{x=l} = 0, \tag{13}$$

$$EI \frac{\partial^3 \delta(x,t)}{\partial x^3} |_{x=l} = M_l \left[ x \ddot{\theta}(t) + \frac{\partial^2 \delta(x,t)}{\partial t^2} \right]_{x=l}, \tag{14}$$

where  $l$  is the length of the arm. Using the Lagrangian equations

$$T = \frac{d}{dt} \left( \frac{\partial L}{\partial \dot{\theta}} \right) - \frac{\partial L}{\partial \theta}, \tag{15}$$

$$0 = \frac{d}{dt} \left( \frac{\partial L}{\partial \dot{\delta}} \right) - \frac{\partial L}{\partial \delta}. \tag{16}$$

With the assumptions that the mass is only concentrated at the tip of the arm (i.e. neglect the weight of the link) and the deflection is small, the dynamic equations which describes the system can be written as

$$\left( I_h + \frac{1}{3} \rho l^3 + M_t l^2 \right) \ddot{\theta}(t) + M_t l \ddot{\delta}(l, t) = T_{arm}(t), \quad (17)$$

$$M_t l \ddot{\theta}(t) + M_t l \ddot{\delta}(l, t) + \frac{3EI}{l^3} \delta(l, t) = 0. \quad (18)$$

#### 4. Controller Design

The control of the single flexible link SFL robot has created a great deal of interest in the control theory field. It can be argued that it has become a benchmark problem for comparing the performance of newly developed control strategies. The reason for this is the inherent difficulty in controlling such a system. This is caused by several factors. First, this is mathematically an infinite-dimensional problem. This will make it very difficult to implement some control strategies, Controllers generally need to be finite-order in order to be implementable (with exception of time delays). Also, the internal damping in the beam is extremely difficult to model accurately, resulting in a plant with parametric uncertainties. Finally, if the tip deflection is chosen as the output, then the transfer function of the plant is nonminimum phase (i.e., it contains unstable zeros). This will make it very difficult to implement some control strategies which are commonly used for conventional rigid link robots. Not only that but the inherent non-minimum phase behavior of the flexible manipulator system makes it very difficult to achieve high level performance and robustness simultaneously. For the methods of collocating the sensors and actuators at the joint of a flexible manipulator, for example, the joint PD control, which is considered the most widely used controller for industrial robot applications, only a certain degree of robustness of the system can be guaranteed. As studied before (Spector & Flashner, 1990) and (Luo, 1993) the robustness of collocated controllers comes directly from the energy dissipating configuration of the resulting system. However, the performance of the flexible system with only a collocated controller, for example, the joint PD controller is often not very satisfactory because the elastic modes of the flexible beam are seriously excited and not effectively suppressed. Due to this reasons, numerous kinds of control techniques have been investigated as shown in section 1 to improve the performance of flexible systems. In general, the desired tip regulation performance of a flexible manipulator can be described as:

- 1- The joint motion converges to the final position fast.
- 2- The elastic vibrations are effectively suppressed.

Obviously there is a trade-off between the two requirements so the successive control try to achieve both of them together.

##### 4.1 Controller analysis

The input for the flexible link system is a step input with a reference angle  $\theta_{ref}$  with no deflection at the tip. Thus, the equivalent effect at the tip position, which is denoted herein as the effective input is ( $l\theta_{ref} +$  zero deflection at the tip). The output of the system is the tip



position, which is defined by rigid arm motion plus tip deflection. The error in the tip position can be defined as (effective input - output). Therefore, the following relation gives the error in the tip position of the flexible arm:

$$\begin{aligned} e(t) &= l [\theta_{ref} - \theta(t)] - \delta(l, t), \\ &= e_j(t) - \delta(l, t), \end{aligned} \quad (19)$$

where  $e(t)$  is the total error in the tip. It is indicated from equation (19) that the error includes two components. The first component  $e_j(t)$  is the tangential position error due to the joint motion and it equals to  $l(\theta_{ref} - \theta(t))$  which is identical with the rigid arm error. The second one is much more important and is due to the flexibility of the arm and equals  $\delta(l, t)$ . These two error components are coupled to each other. On the other hand, a single controller is used to develop a single control signal  $u(t)$  which drives a single actuator in the arm system. The drive torque  $T(t)$  is proportional to the control signal  $u(t)$  as expressed by

$$T(t) = K_1 K_2 G u(t), \quad (20)$$

where  $K_1$ ,  $K_2$  and  $G$  are presented in Table 1.

Thus, the current flexible arm control problem described by the two error components coupled to each other and having only one control command to actuate the joint actuator, is rather complicated and difficult to be solved by traditional controller strategies.

One of the best ways to overcome the problem of inaccuracy in the tip position of the flexible manipulator is to add a vibration feedback from the tip to the controller which control the base joint. Many researchers had used this algorithm like (Lee et al., 1988). They proposed PDS (proportional-derivative-strain) control, which is composed of a conventional PD control and feedback of strain detected at the root of link. Also (Matsuno & Hayashi, 2000), as they proposed the PDS control for a cooperative two one-link flexible arm. Other trails is done by (Ge et al., 1997); (Ge et al., 1998) to enhance the control of the flexible manipulator by using non-linear feedback controller based on the feedback of the vibration signal to the controller.

The Modified PID controller replaces the classical integral term of a PID control with a vibration feedback term to affect the effect flexible modes of the beam in the generated control signal. The MPID controller is formed as follows (Mansour et al., 2008):

$$u(t) = u_{bias} + K_{jp} e_j(t) + K_{jd} \dot{e}_j(t) + K_{vc} g(t) \operatorname{sgn}(\dot{e}_j(t)) \int_0^t |\dot{e}_j(\tau)| g(\tau) d\tau, \quad (21)$$

where  $u_{bias}$  is the bias or null value.

$K_{jp}$ ,  $K_{jd}$  are the joint proportional and joint derivative gains respectively.

$K_{vc}$  is the vibration control gain.

$g(t)$  is the vibration variable used in the controller.

The value of  $u_{bias}$  is the compensated control signal needed for the motor to overcome friction losses without causing any motion to the arm. The sign of this value depends on the

direction of motion, which means that if the arm motion is in the clockwise direction then the value of  $u_{bias}$  is equal to  $(u_{hold})$ , and if the motion of the arm is reversed then the value of  $u_{bias}$  will be  $(-u_{hold})$ . The value of  $u_{bias}$  is evaluated as given in terms of the torque from the motor or voltage to the servo amplifier (Mansour et al., 2008).

The signum function (sgn) is defined as

$$\text{sgn } \dot{e}(t) = \begin{cases} -1 & \dot{e}(t) < 0 \\ 0 & \dot{e}(t) = 0 \\ 1 & \dot{e}(t) > 0 \end{cases} \quad (22)$$

The value of  $e_j(t)$  is defined in equation (19). The vibration variable  $g(t)$  such as  $\frac{\partial^2 \delta(0,t)}{\partial x^2}, \frac{\partial \delta(l,t)}{\partial t}, \dots$  etc.

One of the contributions of this research is the utilizing of rate of deflection signal as an indication of the vibration of the tip to enhance the response of the flexible manipulator. In this research the rate of change of the deflection at the tip  $\dot{\delta}(l,t)$  is chosen as the vibration variable  $g(t)$ , while (Ge et al., 1998) used  $\delta''(0,t)$  for  $g(t)$ . The use of  $\dot{\delta}(l,t)$  has an advantage over the use of  $\delta''(0,t)$  when the flexible-links have quasi-static strains due to gravity or initial strains due to material problems, because  $\dot{\delta}(l,t)$  is not affected by such static deformations. When  $\delta''(0,t)$  is used for  $g(t)$ , the static components in  $\delta''(0,t)$  must be removed by some means. (Ge et al., 1998) did not consider the static deformations; however, such static deformations are generally seen in a real manipulator system.

The mathematical equation for the MPID when using the rate of deflection as the vibration feedback signal is given by:

$$u(t) = u_{bias} + K_{jp} e_j(t) + K_{jd} \dot{e}_j(t) + K_{vc} \dot{\delta}(t) \text{sgn}(\dot{e}_j(t)) \int_0^t |\dot{e}_j(\tau)| \dot{\delta}(\tau) d\tau \quad (23)$$

First, we wish to show the steps for enhancement the classic PD control to reach the MPID. The most common way to enhance the response is to include the vibration of the flexible manipulator in the generated control signal as in (Matsuno & Hayashi, 2000). A joint PD controller, which is given by:

$$u(t) = K_{jp} e_j(t) + K_{jd} \dot{e}_j(t), \quad (24)$$

is compared with an enhancement for the controller by feeding back the deflection signal. The mathematical equation, which represents the controller, in this case is give by:

$$u(t) = K_{jp} e_j(t) + K_{jd} \dot{e}_j(t) + K_d \delta(l,t), \quad (25)$$

where  $K_d$  is the deflection gain.

The response of the flexible manipulator using those two controllers is shown in Fig. 5. As

shown from the response that feeding the deflection had improved the deflection of the response but on the same time, it creates an overshoot on the joint response.

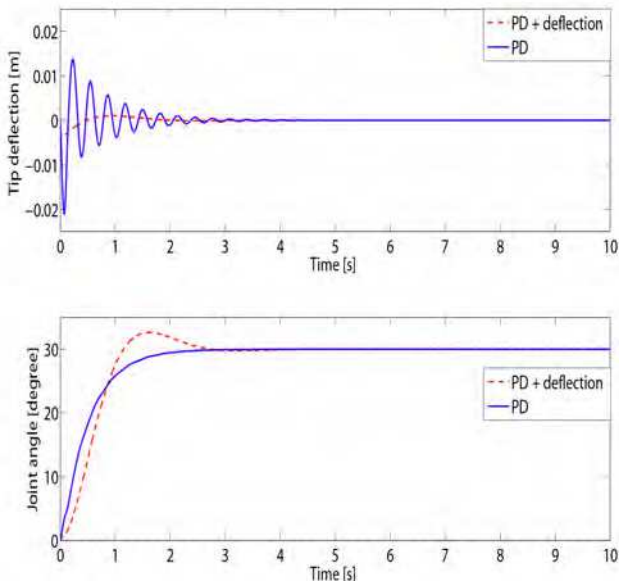

Fig. 5. Step response for the deflection and joint with reference angle  $30^{\circ}$  with 0.5 kg payload using PD and PD plus deflection.

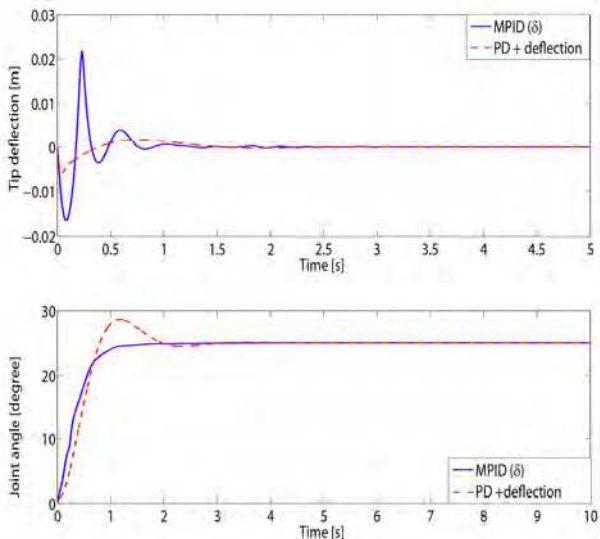

Fig. 6. Step response for the deflection and joint with reference angle  $25^{\circ}$  with 0.5 kg payload.

The next step that we modify the effect of the vibration feedback and use it is an integral form as given by equation (23). The response of the flexible arm corresponding to  $25^\circ$  step input is presented in Fig. 6. Two figures are drawn one for the base joint of the flexible arm and the other for the tip deflection. Two types of controller are tested to control the flexible arm through the joint. First controller is a simple PD controller for the joint plus a proportional gain for the deflection of the tip and the second one is the MPID control.

The response for the first controller is represented with the dotted line while the response using the MPID is plotted using continuous line. The MPID control given by equation (23) uses the rate of deflection  $\dot{\delta}(l,t)$  as a vibration feed back signal.

To compare between the behaviour of the classic PD controller and the proposed MPID controller Fig. 7 is drawn. In this figure both the PD controller and the MPID is used to control the joint of the flexible arm. The continuous lines represent the tip deflection and the joint angle when using the MPID controller while the dotted lines represent them when using PD control.

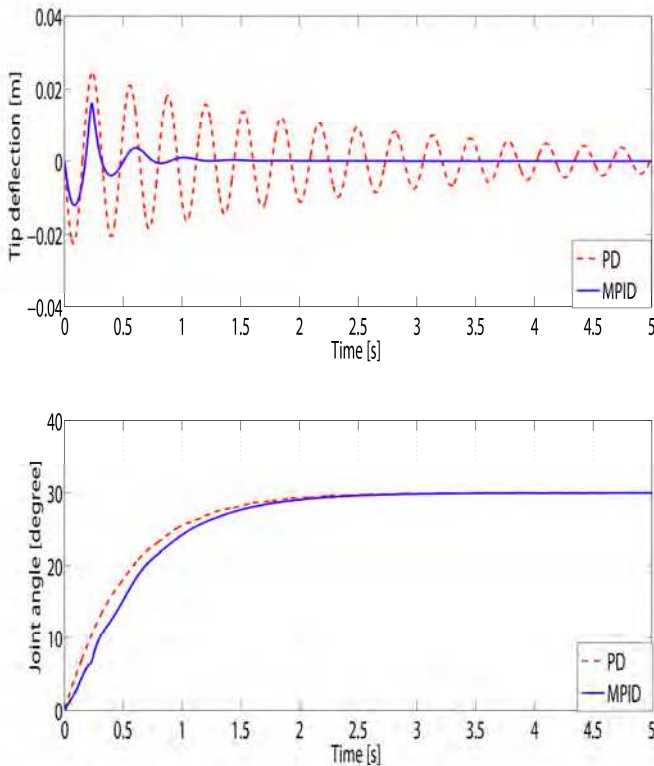

Fig. 7. Step response for the deflection and joint with reference angle  $30^\circ$  with 0.5 kg payload.

As it noticeable from Fig. 7 that the PD control can achieve a fast and accurate response for

the joint but on the same time it increased the oscillations on the tip while the MPID can achieve a damping for the tip deflection on approximate time for reaching the joint angle without causing overshoot for the response of the joint.

A simulation analysis for the single-link flexible manipulator system is presented using MATLAB software package. The mathematical equations used in building the simulation have been discussed in section 3. The aim of the simulation is to highlight the effect of adding the modified term, which contains the vibration feedback variable to the normal servo control for the joint. A simple joint PD controller and MPID controller are examined in the simulation. The MPID controller is compared with the traditional joint PD control to see the merits of using the rate of change of the tip deflection as the vibration variable in the feedback signal. The joint PD control is given by equation (24) while the MPID is designed using the rate of deflection at the tip of the flexible manipulator as the vibration variable  $g(t)$  as shown in equation (23).

**4.2 Stability analysis**

After the MPID control is analysed on subsection 4.1. The stability of the MPID controller around a stationary point  $(\theta, \dot{\theta}) = (\theta_{ref}, 0)$  is analysed in this section. Note that  $\dot{e}_j(t) = -\dot{\theta}(t)$  because  $\theta_{ref}$  is constant.

Fundamental contribution to the stability theory for non-linear systems were made by the Russian mathematician Lyapunov where he investigated the non-linear differential equation

$$\frac{dx}{dt} = f(x), \quad f(0) = 0. \tag{26}$$

Since  $f(x)$  the equation has the solution  $x(t)=0$ . To guarantee that a solution exists and is unique, it is necessary to make some assumptions about  $f(x)$ . A sufficient assumption is that  $f(x)$  is Lipschitz, that is

$$\|f(x) - f(y)\| \leq L \|x - y\|, \quad L > 0, \tag{27}$$

in the neighborhood of the origin. Before we proceed in the stability prove two important definitions needs to be highlighted.

- 1- The solution  $x(t) = 0$  to the differential equation (26) is called stable for given  $\epsilon > 0$  there exists a number  $\zeta(\epsilon) > 0$  such that all solutions with initial conditions

$$\|x(0)\| < \zeta, \tag{28}$$

have the property

$$\|x(t)\| < \epsilon, \quad 0 \leq t < \infty, \tag{29}$$

the solution is unstable if it is not stable. The solution is asymptotically stable if it is stable and  $\zeta$  can be found such that all solutions with  $\|x(0)\| < \zeta$  have the property that

$$\|x(0)\| \rightarrow 0 \quad \text{as } t \rightarrow \infty . \quad (30)$$

2- A continuously differentiable function  $V : R^n \rightarrow R$  is called positive definite in a region  $U \subset R^n$  contains the origin if

$$1- V(0) = 0$$

$$2- V(x) > 0, \quad x \in U \quad \text{and } x \neq 0,$$

and the function is called positive semi-definite if condition 2 is replaced by  $V(x) \geq 0$ .

As stated by the Lyapunov stability theorem, If there exists a function  $V : R^n \rightarrow R$  that is positive definite such that its derivative along the solution of equation (26),

$$\frac{dV}{dt} = \frac{\partial V^T}{\partial t} \frac{dx}{dt} = \frac{\partial V^T}{\partial t} f(x) = -W(x), \quad (31)$$

is negative semi-definite, then the solution  $x(t) = 0$  to equation (26) is stable. If  $\frac{dV}{dt}$  is negative definite, then the solution is also asymptotically stable. The function  $V$  is called a Lyapunov function for the system.

To check the stability of the MPID controller we start by forming the Lyapunov function  $V(t)$ .  $V(t)$  is formed using the following relation

$$V(t) = K_E + P_E + \frac{1}{2} K_1 K_2 K_{jp} G e_j^2(t) + \frac{1}{2} K_1 K_2 K_{vc} G \left[ \int_0^t |\dot{e}_j(\tau)| \dot{\delta}(\tau) d\tau \right]^2, \quad (32)$$

where  $K_E$  is the total kinetic energy of the system and  $P_E$  the total potential energy of the system.

From the analysis of the flexible link manipulator system, the total Kinetic energy of the system can be calculated by

$$K_E = K_{Em} + K_{Eb} + K_{Ep}, \quad (33)$$

Where  $K_{Em}$ ,  $K_{Eb}$ ,  $K_{Ep}$  are the kinetic energy of the motor, beam and payload respectively. And

$$K_{Em} = \frac{1}{2} I_h \dot{\theta}^2(t), \quad (34)$$

$$K_{Eb} = \frac{1}{2} \rho \int_0^l \dot{p}^2(x, t) dx, \quad (35)$$

$$K_{Ep} = \frac{1}{2} M_l \dot{p}^2(l, t). \quad (36)$$

By substituting equations (34), (35), (36) into (33), the total kinetic energy of the system can be rewritten as

$$K_E = \frac{1}{2} I_h \dot{\theta}^2(t) + \frac{1}{2} \rho \int_0^l \dot{p}^2(x, t) dx + \frac{1}{2} M_l \dot{p}^2(l, t) \cdot \quad (37)$$

Consider that the beam only vibrates in horizontal direction, any effect of gravity are neglected such that the potential energy of the system is

$$P_E = \frac{1}{2} EI \int_0^l \left[ \frac{\partial^2 p(x, t)}{\partial x^2} \right]^2 dx \cdot \quad (38)$$

Recalling equation (7), the total potential energy of the system can be rewritten as

$$P_E = \frac{1}{2} EI \int_0^l \left[ \frac{\partial^2 \delta(x, t)}{\partial x^2} \right]^2 dx \cdot \quad (39)$$

Differentiating equation (32) and (37) with respect to time gives

$$\begin{aligned} \dot{V}(t) = & \dot{K}_E + \dot{P}_E + K_1 K_2 K_{jp} G e_j(t) \dot{e}_j(t) \\ & + K_1 K_2 K_{vc} G \dot{e}_j(t) \operatorname{sgn}(\dot{e}_j(t)) \dot{\delta}(\tau) \int_0^l |\dot{e}_j(\tau)| \dot{\delta}(x, \tau) d\tau, \end{aligned} \quad (40)$$

$$\dot{K}_E = I_h \dot{\theta}(t) \ddot{\theta}(t) + \rho \int_0^l \dot{p}(x, t) \ddot{p}(x, t) dx + M_l \dot{p}(l, t) \ddot{p}(l, t) \cdot \quad (41)$$

From equation (7) the middle term of equation (41) can be written as

$$\begin{aligned} & \rho \int_0^l [x \dot{\theta}(t) + \dot{\delta}(x, t)] [x \ddot{\theta}(t) + \ddot{\delta}(x, t)] dx \\ & = \rho \int_0^l [x^2 \dot{\theta}(t) \ddot{\theta}(t) + x \dot{\theta}(t) \ddot{\delta}(x, t) + x \dot{\delta}(x, t) \ddot{\theta}(t) + \dot{\delta}(x, t) \ddot{\delta}(x, t)] dx \\ & = \frac{1}{3} \rho l^3 \dot{\theta}(t) \ddot{\theta}(t) + \rho \int_0^l [x \dot{\theta}(t) \ddot{\delta}(x, t) + \dot{\delta}(x, t) [x \ddot{\theta}(t) + \ddot{\delta}(x, t)]] dx, \end{aligned} \quad (42)$$

substituting equations (7) and (42) into equation (41) gives

$$\begin{aligned} \dot{K}_E = & I_h \dot{\theta}(t) \ddot{\theta}(t) + \frac{1}{3} \rho l^3 \dot{\theta}(t) \ddot{\theta}(t) + \rho \int_0^l \dot{\delta}(x, t) [x \ddot{\theta}(t) + \ddot{\delta}(x, t)] dx \\ & + \rho \dot{\theta}(t) \int_0^l x \ddot{\delta}(x, t) dx + M_l l \dot{\theta}(t) [l \ddot{\theta}(t) + \ddot{\delta}(l, t)] + M_l \dot{\delta}(l, t) [l \ddot{\theta}(t) + \ddot{\delta}(l, t)]. \end{aligned} \quad (43)$$

$$\dot{K}_E = \dot{\theta}(t) \left[ I_h \ddot{\theta}(t) + M_l l [l \ddot{\theta}(t) + \ddot{\delta}(x, t)] + \frac{1}{3} \rho l^3 \ddot{\theta}(t) + \rho \int_0^l x \ddot{\delta}(x, t) dx \right]$$

$$+ M_l \dot{\delta}(l,t) [l\ddot{\theta}(t) + \ddot{\delta}(l,t)] + \rho \int_0^l \dot{\delta}(x,t) [x\ddot{\theta}(t) + \ddot{\delta}(x,t)] dx \cdot \quad (44)$$

Substituting equation (17) into (44), we have

$$\dot{K}_E = T_{arm}(t)\dot{\theta}(t) + M_l \dot{\delta}(l,t) [l\ddot{\theta}(t) + \ddot{\delta}(l,t)] + \rho \int_0^l \dot{\delta}(x,t) [x\ddot{\theta}(t) + \ddot{\delta}(x,t)] dx \cdot \quad (45)$$

From equation (10), using integration by parts with the fourth boundary condition is it proved that

$$\dot{K}_E + \dot{P}_E = T_{arm}(t)\dot{\theta}(t) \cdot \quad (46)$$

Substituting equation (46),(20) and (21) into equation (40) we get

$$\dot{V}(t) = -K_1 K_2 K_{jd} G \dot{\theta}^2(t) \ , \quad (47)$$

which is negative semi-definite as long as  $K_{jd} \geq 0$  which means that the system is stable.

After showing the controller analysis and the stability analysis, some important points need to be highlighted.

- Include the deflection effect in the controller enable generating a control signal take into consideration the effect of the end effector vibration. The generated control signal have the ability to achieve accurate tip position without neither overshoot for the joint nor vibration at the tip.
- Only three measurements needed to apply this controller, the measurements are the base joint angle  $\theta(t)$ , base joint velocity  $\dot{\theta}(t)$  and the rate of deflection  $\dot{\delta}(l,t)$  unlike other types of controller which needs a full states measurements like (Cannon & Schmitz, 1984) and (Siciliano, 1988).
- The stability of the system is shown experimentally and theoretically when using the rate of deflection at the tip  $\dot{\delta}(l,t)$  as the vibration signal in the controller. The stability is depend mainly of the joint derivative gain  $K_{jd}$  and will not be affected by the vibration feedback.

## 5. Case study

In this section, we test the proposed MPID control with the rate of change of deflection  $\dot{\delta}(l,t)$  as a vibration signal to control a single link moving horizontally. The MPID represented by equation (23) is compared in simulation with a PI control as a classic control. The main function of the integral action in the PI is to make sure that the system output agrees with the set point in steady state. The equation representing the PI controller is



$$u(t) = u_{bias} + K_p e(t) + K_i \int_{t_0}^{t_f} e(\tau) d\tau \tag{48}$$

where  $K_p, K_i$  are the proportional and integral feedback gains, respectively. The PI control is represented by equation (49)

$$u(t) = u_{bias} + K_{jp} e_j(t) + K_{ji} \int_{t_0}^{t_f} e_j(\tau) d\tau + K_{dp} \delta(t) + K_{di} \int_{t_0}^{t_f} \delta(\tau) d\tau \tag{49}$$

where  $K_{jp}, K_{ji}$  are the joint proportional, joint integral gains while  $K_{dp}, K_{di}$  are the and deflection proportional, deflection integral gains respectively. As the tip deflection response is oscillatory, we set the deflection integral gain in equation (49) equal to zero to eliminate this problem. The mathematical equation representing the PI controller in this case is given by:

$$u(t) = u_{bias} + K_{jp} e_j(t) + K_{dp} \delta(t) + K_{ji} \int_{t_0}^{t_f} e_j(\tau) d\tau \tag{50}$$

### 5.1 Simulation results

A simulation model using MATLAB-Simulink software is used to simulate the performance of the controller with different working conditions. As shown previously in section 3 the mathematical model of the flexible arm is used in the simulation.

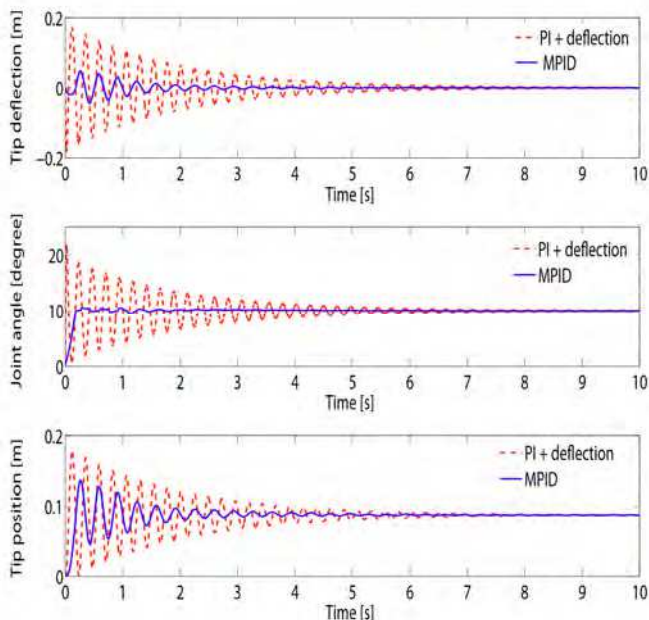

Fig. 8. Step response for the reference angle  $10^0$  with 0.5 kg payload (simulation).

The system does not model the friction of the motors so in the simulation we put the value of  $u_{bias}$  equals zero. As shown in Fig. 8 the dotted represents the response of the system when using the PI control plus the deflection feedback while the continuous line represents the response of the system when using the MPID given by equation (23).

It is clear that the MPID control can successfully suppress the vibration at the end effector of the flexible manipulator while it does not create an over shoot on the joint response. After changing the tip payload and the input angle of the manipulator, the MPID control success to achieve a noticeable damping for the tip deflection of the flexible manipulator compared with the PI control as shown in Fig. 9. Compared with the MPID control based on rate of deflection at the tip as a vibration variable, the PI control can achieves an accurate joint angle at the steady state but it have an undesirable effect on the vibration of the end effector.

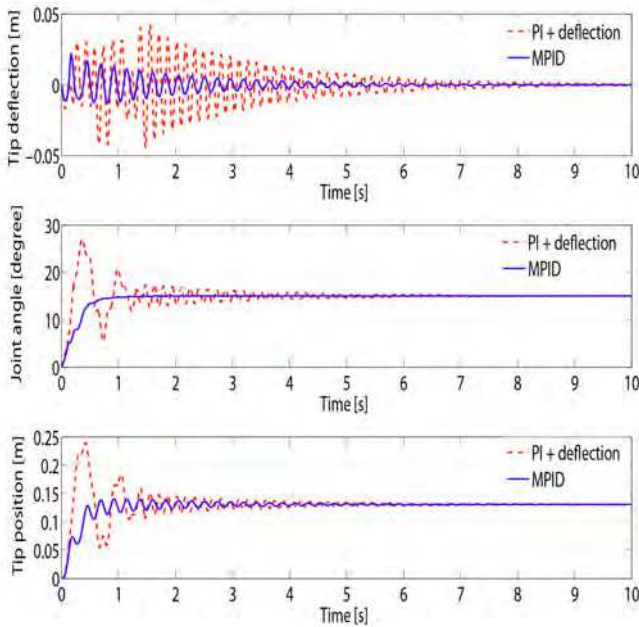
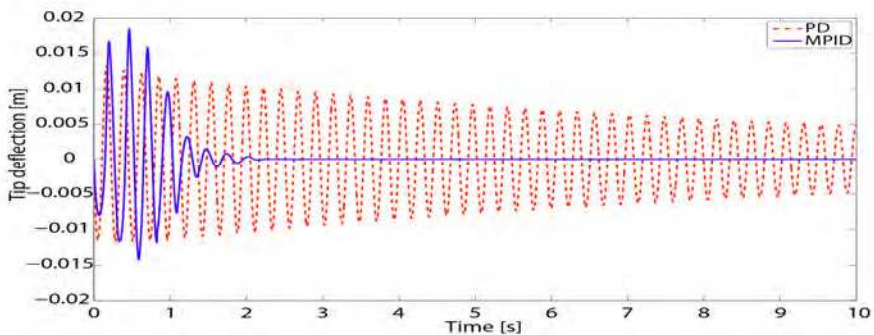
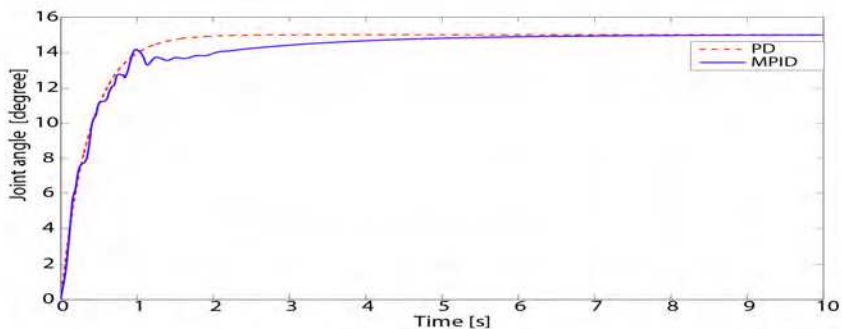

Fig. 9. Step response for the reference angle  $15^\circ$  with 0.25 kg payload (simulation).

Another set of simulation results is obtained by comparing the MPID with the PD joint control. Different payloads of 0.25 kg and 0.5 kg are tested in the simulation. A simulation result for the step input of  $15^\circ$  with tip payload 0.25 kg is shown in Fig. 10. The joint proportional gain  $K_{jp}$  and the joint differential gain  $K_{jd}$  for both PD and MPID control are set to be equal. The vibration control gain  $K_{vc}$  equals  $744340 \text{ V}\cdot\text{s}^2/\text{rad}\cdot\text{m}^2$ . The MPID succeeded to suppress the vibration in the tip of the flexible manipulator after 2 seconds as shown in Fig. 10(a). On the same time the joint angle reached its desired value.



(a) Tip deflection with input  $15^\circ$ .



(b) Joint angle with input  $15^\circ$ .

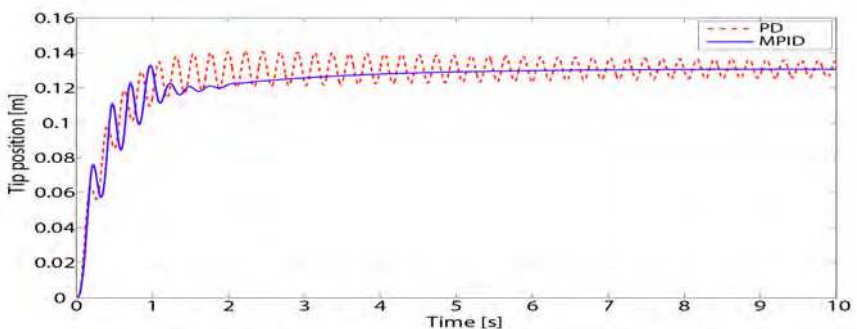

(c) Tip position with input  $15^\circ$ .

Fig. 10. Step response for the reference angle  $15^\circ$  with 0.25 kg payload (simulation).

**5.2 Experimental results**

Since the performance of the new scheme is confirmed by simulation in the previous subsection, now it will be tested experimentally with PI controller as a classical controller. The experimental setup which had been highlighted before is used to verify the efficient of the MPID control. The MPID control given by equation (23) and PI control given by equation (50) are tested experimentally.

The experimental results of the tip position and the tip deflection with both PI and MPID controllers are shown for different payloads. The value of  $u_{bias}$  in equations (50) and (23) is determined experimentally. As a vibration variable  $g(t)$  in equation (21), the tip velocity is chosen in the experiments. The gains for the PI in is optimized using Ziegler- Nichols method while for the MPID it is first treated as PD controller to get the optimum gains then by trial and error get the values of  $K_{vc}$ . The response when using MPID controller is indicated with the continuous line, while the response with PI is indicated with the dashed line.

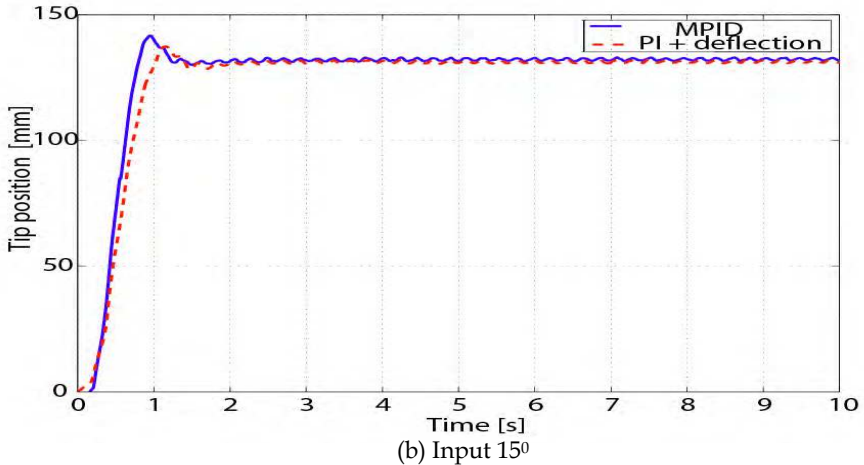
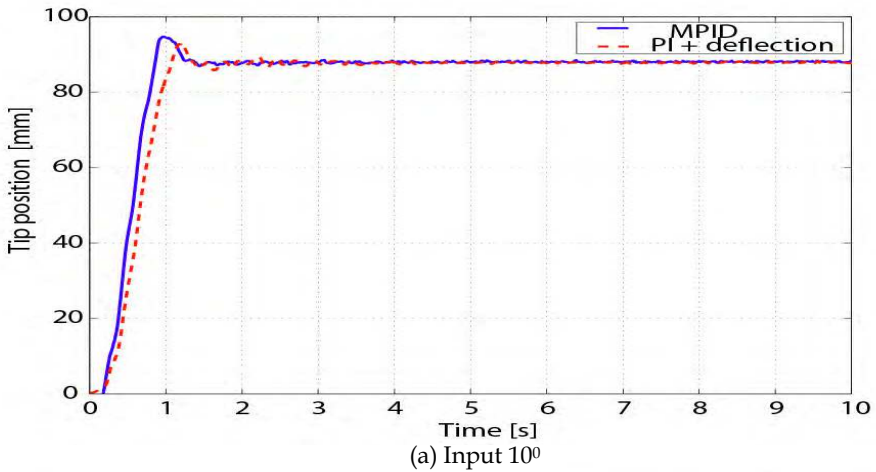
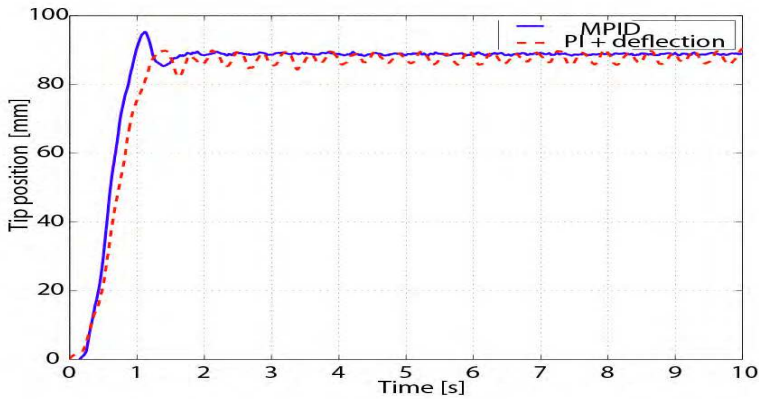
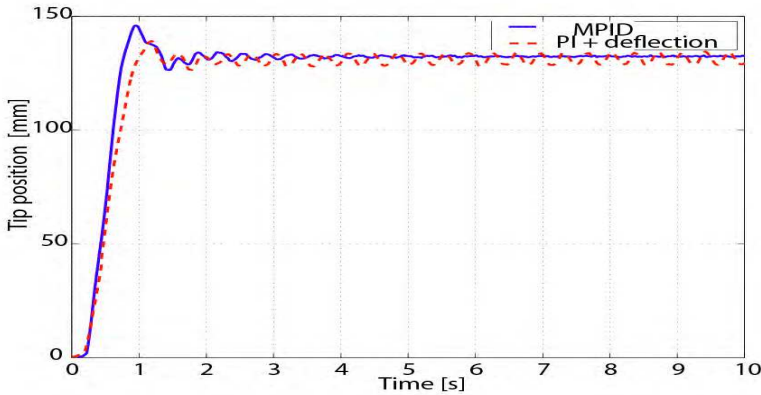

Fig. 11. Tip position with 0.25 kg payload for  $10^0$  and  $15^0$  step input (experimental).

First, a 0.25 kg tip payload is used, and tip position response with  $10^0$  step input for the joint angle shown in Fig. 11(a) and a step input response with  $15^0$  is shown in Fig. 11(b). Using the MPID the steady state error  $e_{ss}$  has a value of  $\pm 0.1$  mm, while it reaches a value of  $\pm 1.3$  mm when using PI controller for the same step input. It is noticed from the response that the MPID has a desirable response especially near the steady state.



(a) Input  $10^0$



(b) Input  $15^0$

Fig. 12. Tip position with 0.5 kg payload for  $10^0$  and  $15^0$  step input (experimental).

After then the tip payload is increased to 0.5 kg and the tip response is recorded. In Fig. 12(a) and (b) the response of the single-link flexible arm is indicated. The same gains for both of the controllers, PI and MPID are used in the new experiment. In this case also the MPID gives a speedy rise time;  $t_r$  for the response of the tip position equals 0.95 s and  $e_{ss} \pm 0.2$  mm while the PI shows rise time,  $t_r$  1.23 s and steady state error  $\pm 2.0$  mm.

To focus on the effect of the MPID controller on the response, the tip deflection with a 0.25 kg tip payload is shown in Fig. 13 (a) and also for the 0.5 kg tip payload appeared on Fig. 13 (b). It is well noticed that MPID controller could succeed to make remarkable vibration suppression for tip deflection of the single-link flexible arm.

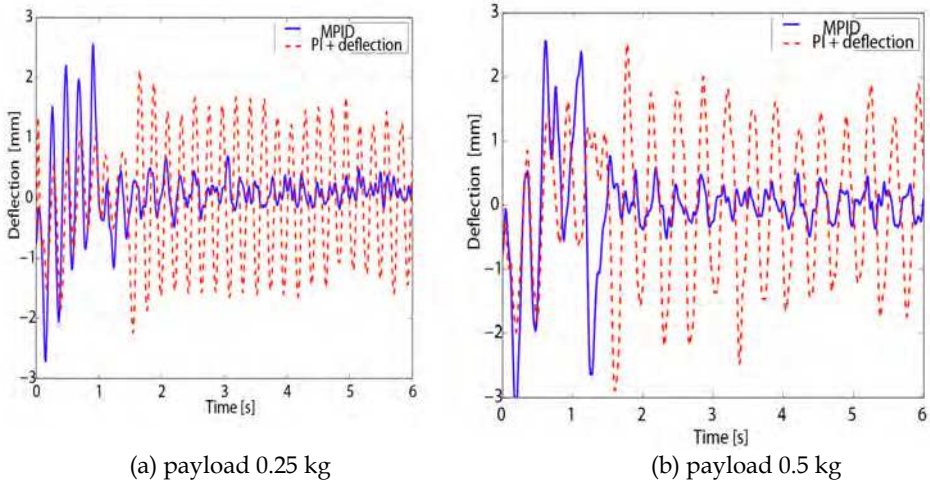

Fig. 13. Tip deflection with different payload (experimental).

## 7. Conclusion

In this chapter, a Modified Proportional-Integral-Derivative (MPID) controller is utilized to solve the problem of achieving an accurate tip position of a flexible manipulator. The aim of the control of the flexible manipulator is to achieve the final position of the manipulator with the minimal vibration. The controller consists of a PD for the joint and an integral term including the vibration of the tip. As a result introducing vibration feedback, compared with traditional joint PD control allows explicit evaluation of vibration and, thus, provides explicit control effort in vibration suppression. The rate of change in the deflection of the tip is used as a vibration feedback signal in the MPID. In addition, the way the rate of deflection is used as a vibration feedback is different from other similar work. The advantage of the proposed MPID controller over the strain-based MPID controller is that the proposed controller does not receive a bad influence from the quasi-static strain or initial strain of the flexible links. The performance of the MPID controller is evaluated by simulation study. An experimental validation of the tip position control of a single-link flexible arm is carried out using the MPID. The implementation of the MPID showed that it is an easy controller to use. The MPID is compared with other standard controller in theoretical and experimental. The comparison shows good behavior for the MPID. The settling time of the flexible manipulator using the MPID control is noticeably shorter compared with other control method. This will enable a fast task execution. The stability of the proposed controller is tested and it was proven that this controller can achieve stable operation for the flexible manipulator. The future work is aimed to extend the use of MPID with the rate of deflection as vibration signal in the multiple link flexible manipulator.

## 8. References

Cannon, R. H. & Schmitz, J. E. (1984). Initial experiments on the end-point control of a flexible one-link robot, *Int. J. of Robotics Research*, Vol. 3, No. 3, pp. 62-75, 0278-3649.

- Etxebarria, A.; Sanz, A. & Lizarraga, I. (2005). Control of a Lightweight Flexible Robotic Arm Using Sliding Modes, *Int. J. of Advanced Robotic Systems*, Vol. 2, No. 2, pp. 103- 110, 1729-8806
- Ge, S. S.; Lee, T. H. & Zhu, G. (1997). A nonlinear feedback controller for a single link flexible manipulator based on a finite element model, *J. of Robotic Systems*, Vol 14, No. 3, pp. 165-178, 0741-2223.
- Ge, S. S.; Lee, T. H. & Zhu, G. (1998). Asymptotically stable end-point regulation of a flexible SCARA/Cartesian robot, *IEEE/ASME Transactions on Mechatronics*, Vol. 3, No. 2, pp. 138-144, 1083-4435.
- Kariz, Z. & Heppler, G. R. (2000). A Controller for an Impacted Single Flexible Link, *Journal of Vibration and Control*, Vol. 6, No. 3, pp 407-428, 1077-5463.
- Lee, H. G.; Arimoto, S. & Miyazaki, F. (1988). Liapunov stability analysis for PDS control of flexible multi-link manipulators, *Proc. of IEEE Conf. of Decision and Control*, Austin, pp. 75-80.
- Luo, Z. (1993). Direct strain feedback control of flexible robot arms: New theoretical and experimental results, *IEEE Trans. on Automatic Control*, Vol. 38, No. 11, pp. 1610-1622, 0018-9286.
- Mansour, T.; Konno, A. & Uchiyama M. (2008). Modified PID Control of a Single- Link flexible Robot, *Advanced Robotics*, Vol. 22, No. 4, pp. 433-449, 0169-1864.
- Matsuno, M. & Hayashi, A. (2000). PDS cooperative control of two one-link flexible arms, *Proc. of IEEE Int. Conf. on Robotics and Automation*, San Francisco, pp. 1490-1495.
- Meirovitch, L. (1967). *Analytical Methods in Vibrations*, Macmillan Publishing Co., 0-02-3801409, NewYork
- Menq, C. & Xia, J. Z. (1993). Experiments on the Tracking Control of A Flexible One-Link Manipulator, *Trans. of ASME, J. of Dynamic Systems, Measurement and Control*, Vol. 115, No. 2, pp. 306-308, 0022-0434.
- Rai, S. & Asada, H. (1995). Integrated Structure/Control Design of High Speed Flexible Robots Based on Time Optimal Control, *Trans. of ASME, J. of Dynamic Systems, Measurement and Control*, Vol. 117, No. 4, pp. 503-512, 0022-0434.
- Siciliano, B. & Book, W. J. (1988). A singular perturbation approach to control of lightweight flexible manipulators, *Int. J. of Robotics Research*, Vol. 7, No. 4, pp. 79-90, 0278-3649.
- Spector, V. A. & Flashner, H. (1990). Modelling and design implications of noncollocated control in flexible systems. *Trans. of ASME, J. of Dynamic Systems, Measurement and Control*, Vol. 112, No. 2, pp. 186-193, 0022-0434.
- Tawfeic, S. R. ; Baz A.; Abo-Ismael A. A. & Azim, O. A. (1997). Vibration Control of a Flexible Arm with Active Constrained Layer Damping, *Journal of Low Frequency Noise, Vibration And Active Control*, Vol. 16, No. 4, pp. 271-287, 1461-3484.
- Zhu, W. D. & Mote, C. D. (1997). Dynamic Modelling and Optimal Control of Rotating Euler-Bernoulli Beams, *Trans. of ASME, J. of Dynamic Systems, Measurement and Control*, Vol. 119, No. 4, pp. 802-808, 0022-0434.







## **Robot Manipulators New Achievements**

Edited by Aleksandar Lazinica and Hiroyuki Kawai

ISBN 978-953-307-090-2

Hard cover, 718 pages

**Publisher** InTech

**Published online** 01, April, 2010

**Published in print edition** April, 2010

Robot manipulators are developing more in the direction of industrial robots than of human workers. Recently, the applications of robot manipulators are spreading their focus, for example Da Vinci as a medical robot, ASIMO as a humanoid robot and so on. There are many research topics within the field of robot manipulators, e.g. motion planning, cooperation with a human, and fusion with external sensors like vision, haptic and force, etc. Moreover, these include both technical problems in the industry and theoretical problems in the academic fields. This book is a collection of papers presenting the latest research issues from around the world.

### **How to reference**

In order to correctly reference this scholarly work, feel free to copy and paste the following:

Tamer Mansour, Atsushi Konno and Masaru Uchiyama (2010). Vibration Based Control for Flexible Link Manipulator, Robot Manipulators New Achievements, Aleksandar Lazinica and Hiroyuki Kawai (Ed.), ISBN: 978-953-307-090-2, InTech, Available from: <http://www.intechopen.com/books/robot-manipulators-new-achievements/vibration-based-control-for-flexible-link-manipulator>

# **INTECH**

open science | open minds

### **InTech Europe**

University Campus STeP Ri  
Slavka Krautzeka 83/A  
51000 Rijeka, Croatia  
Phone: +385 (51) 770 447  
Fax: +385 (51) 686 166  
[www.intechopen.com](http://www.intechopen.com)

### **InTech China**

Unit 405, Office Block, Hotel Equatorial Shanghai  
No.65, Yan An Road (West), Shanghai, 200040, China  
中国上海市延安西路65号上海国际贵都大饭店办公楼405单元  
Phone: +86-21-62489820  
Fax: +86-21-62489821

© 2010 The Author(s). Licensee IntechOpen. This chapter is distributed under the terms of the [Creative Commons Attribution-NonCommercial-ShareAlike-3.0 License](#), which permits use, distribution and reproduction for non-commercial purposes, provided the original is properly cited and derivative works building on this content are distributed under the same license.