

Metal Laser Sintering for Rapid Tooling in Application to Tyre Tread Pattern Mould

Jelena Milovanovic, Milos Stojkovic and Miroslav Trajanovic
*University of Nis, Faculty of Mechanical Engineering in Nis
Republic of Serbia*

1. Introduction

SLS¹, DMLS² and SLM³ belong to the family of additive manufacturing technologies (we will use term Metal Laser Sintering technologies or MLS abbreviation further in text due to simplicity) that build the geometry of the part by solidification of metal powders using laser power (Kruth et al., 2005; Khaing, 2001). What particularly distinguishes them from other additive technologies is the possibility to produce fully functional metal parts. This feature as well as the ability to create highly complex geometrical shapes, which are often not possible, or at least very difficult to make by conventional manufacturing processes, promote these technologies as perfect candidates for moulding and rapid tooling (RT) (Simchi et al., 2003; Pessard et al. 2008). This is why MLS technologies attract a great attention of mouldmakers for more than a decade. On the other side, the whole range of features of the parts that are manufactured by MLS technologies such as high price of metal powder, porosity, chemical reactivity, then the limitations regard to geometric accuracy, available materials, size of building chambers and necessity for additional post-processing create a barrier for the application of these technologies in manufacturing of moulds.

Especially, production of large parts and moulds rich in small and complex geometric details, such as tyre tread pattern mould, still remains a great challenge for MLS. Nevertheless, it is very interesting to find out whether and how MLS technologies could be employed for manufacturing of these kind of moulds. In these cases, there is a clue that usage of MLS could be made worthwhile, but it could require specific tooling approaches to be considered. In this chapter, an application study is presented which concerns application of metal laser sintering technologies for rapid tooling in application to tyre tread pattern mould.

2. Review of applications of DMLS/SLS/SLM in RT

Over the years there are more and more examples of application of MLS technologies in rapid tooling. What makes them a particularly attractive in the mould industry is the ability to create and integrate so called conformal channels into injection molds or other tooling,

¹ Selective Laser Sintering

² Direct Metal Laser Sintering

³ Selective Laser Melting

which can reduce injection cycle times between 30 and 60 percent over conventional tools and even increase parts quality (Xu et al., 2001).

Some industrial case studies of laser sintered injection moulds using DMLS and SLS have been reported in (Voet et al., 2005). These cases show that it is possible to manufacture moulds with MLS technologies, where cavity depth and complexity do not limit of the process. However, finishing of laser sintered parts using traditional manufacturing technologies is proved to be necessary.

There are also reports on successful use of combination of indirect SLS and machining processes to create injection mould tools which have been evaluated in industrials trials. (Ilyas et al., 2010; King & Tansey, 2003).

One of many examples that confirm the benefits and importance of making conformal channels using MLS technologies (in this case SLM) is presented in (Campanelli et al., 2010) where SLM is used for creation of jig for welding of constituent parts of titanium alloy intramedullary nail.

MLS technologies are also used for die-casting applications. In (Ferreira, 2004) author presented good results in application of DMLS for manufacturing of die inserts for shoot squeeze moulding under full production conditions (for 3750 sand moulds). DMLS shows benefits in reducing manufacturing time and achieving acceptable geometrical accuracy of die, both for low and medium production.

Mainly, all of these examples are related to application of these technologies for manufacturing of relatively small parts and small size moulds. One of the main features that have been observed regarding the use of MLS technologies in tools manufacturing is that the quality of tools significantly depends on the composition and grain sizes of the powder as well as sintering conditions. Small grain sizes of powder provide better overall geometrical accuracy and surface quality. Yet, some practical problems as powder removal and porosity should be further solved.

3. Fabrication of tyre vulcanization mould

Tyre vulcanization mould is a very specific and complex kind of mould that can be considered as a large tool (Fig.1).



Fig. 1. Tyre vulcanization mould.

It is characterized by large number of very complex geometrical features, which are often very difficult to machine in a conventional way. The most complex part of the mould is tread pattern ring (further in text *tread ring*) (Fig.2) which is characterized by inverse tyre tread geometry. The complexity of tread ring is manifested primarily by its toroidal shape containing different kind of ribs (circumferential, lateral, esthetic and sipes or lamellas) (Stojkovic & Trajanovic, 2001; Stojkovic et al. 2003; Stojkovic et al. 2005a, 2005b; Chu et al 2006; Lee, 2008) .

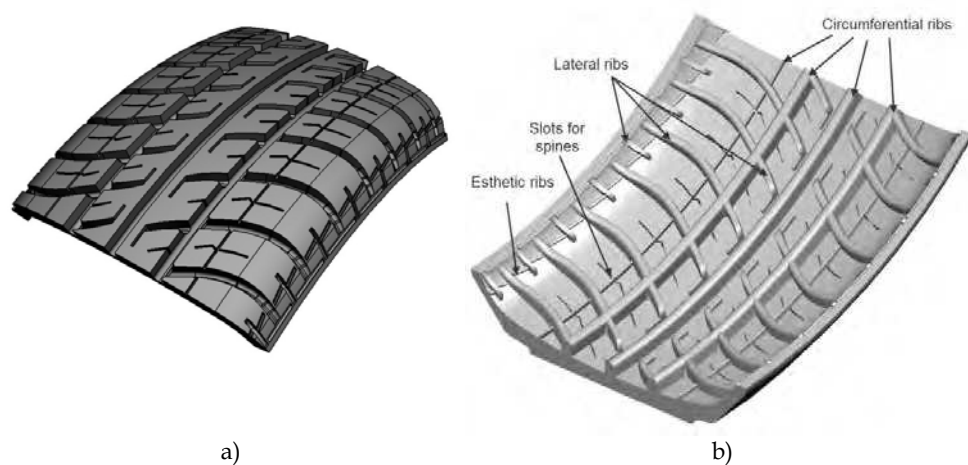

Fig. 2. CAD models of: a) tyre tread segment and b) segment of tread ring of tyre mould.

In addition, the mould is characterized by considerable difference in dimensions between the smallest and biggest geometrical features (Fig.3).

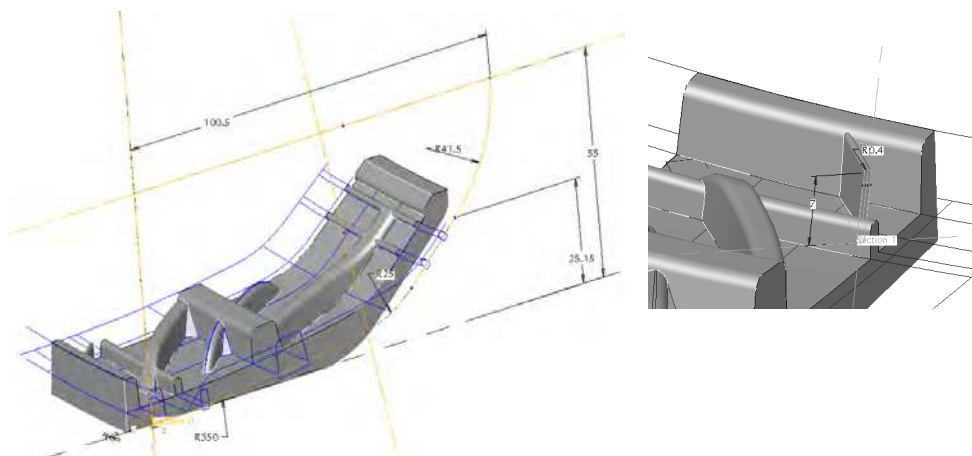

Fig. 3. Dimensional range of geometrical features of the tread ring segment.

3.1 Conventional tooling

Conventional manufacturing process of tread ring involves complex (4- or 5-axis) machining and precise die-casting, which make tooling process very intricate, time consuming and expensive (Fleming, 1995). Therefore, development of new tyre models is limited in great extent by the manufacturability of tread ring and its geometrical features. There are two main conventional approaches in manufacturing of the tread ring as it is explained by (Salaorni & Pizzini, 2000; Knedla, 2000).

1. Direct manufacturing of mould segments is used for getting the so-called *engraved* moulds, which can be produced by two different manufacturing procedures:
 - a. Engraving of mould segments by 5- axis CNC milling machines (Fig.4).
 - b. Electro-discharge machining of tread ring by sinking tread-like copper or brass electrode.



Fig. 4. Tread ring segment made by engraving on CNC.

2. Indirect manufacturing is used for getting the so-called casted moulds. These moulds are usually produced by standard three-step casting procedure (Chu et al., 2006; Fleming, 1995). This is the most often used manufacturing procedure for this purpose and it is appropriate for manufacturing of all kind of segmented moulds.

The moulds which are manufactured by this procedure are shown in Fig. 5_a and Fig. 5_b.



a)



b)

Fig. 5. a) *Monoblock* tyre vulcanization mould system b) 1/8 of tread ring segment.

3.1.1 Utilization features of the conventionally manufactured moulds

The tread rings that are produced by conventional manufacturing procedures should meet certain specifications which are shown in Table 1.

Feature	Value
Nominal dimension tolerances	$\pm 0.2\text{mm}$ on overall diameter of tyre (app. up to 600mm)
Surface roughness	$Ra=3.2 - 6.30 (\mu\text{m})^4$
Working temperature and pressure	180 °C / 21 bar
Hardness	70HRB
Thermal conductivity	122 - 134 W/(mK) 25 °C - 200 °C ⁴
Corrosion and wear resistance	2500 to 3000 vulcanization cycles before regular maintenance procedure (sandblasting, laser cleaning, etc.)

Table 1. Specifications (utilization features) of tread ring (data source: Rubber product company Tigar Tyres, now incorporated in Michelin).

3.2 MLS technologies for tyre tread ring mould fabrication

First of all, one should notice that all kind of layer manufacturing technologies (the whole family of so-called rapid prototyping (RP) technologies) attract a great attention of tyre mould makers because of their remarkable capabilities to produce almost any kind of shape in a relatively simple way. Although, there is a possibility to use all kind of RP technologies, MLS technologies appear as the most suitable for alternative production process of tread rings of tyre moulds (Milovanovic et al., 2005; Milovanovic, 2006; Milovanovic et al., 2009).

Compared to other RP technologies the greatest strength of MLS technologies is certainly the possibility to create fully functional parts i.e. parts of the mould with any shape that can be found on the tread ring. In addition, the simplicity of digital model preprocessing and fabrication process planning usually takes 10% of time which has to be invested in CAPP/CAM⁵ activities that precede CNC machining⁶. The time savings for the model preprocessing cause a secondary, but very important advantage. It is manifested in the extraordinary flexibility of tyre development. The simplicity of building the mould prototype contributes to the easier and faster development and testing of new tyres.

One of the most important limitations of MLS technology applications in the production of tyre mould is the size of chambers (Table 2). Concerning the application of MLS in tyre moulding, the largest piece of tread ring for the passenger tyre 205/60 R15 is 1/8 segment (Table 3).

⁴ This values are given for silumin, which is commonly used alloy for tyre mould manufacturing (eutectic alloy AlSi, with 12 % Si).

⁵ CAPP - Computer Aided Process Planning, CAM - Computer Aided Manufacturing

⁶ Summary report on project No. 0231 „Computer aided tire development“ (2002-2005) that was conducted at University of Nis, Faculty of Mechanical Engineering in Nis under the sponsorship of Ministry of Science, Technology and Development of Serbia for Rubber Products Company TIGAR from Pirot, Serbia. (in Serbian)

Method	SLM (MCP Realizer ^{SLM})	SLS (Vanguard SLS)	DMLS (EOSINT 270)
Building area	250 x 250 x 240 (mm)	370 x 320 x 445 (mm)	250 x 250 x 215 (mm)

Table 2. Maximal part building area of SLM/SLS/DMLS chambers.

Tyre size	1/12 segment (mm)	1/9 segment (mm)	1/8 segment (mm)
205/60 R15 OD = 630 (mm) (overall diameter)	L<164 W<200	L<216 W<200	L<242 W<200

Table 3. Segment size for particular tyre dimension 205/60 R15.

In order to identify whether these technologies meet specific values of utilization features, an application study was performed.

4. Application study

The application study was consisted of two parts. The first one is focused on question whether the MLS technologies could be used for manufacturing the tread ring finding out what are the utilization features of samples produced by MLS. In addition, this part of application study had to show what MLS technology is the most suitable one for tread ring manufacturing.

The second part of application study was devoted to answer following question: if there is any kind of MLS technology that fulfills requirements in regard to utilization features then, how that or these MLS technology(ies) should be employed to manufacture tread ring in a worthwhile manner.

4.1 Application study of SLM/SLS/DMLS – Technology issues

Application study of SLM, SLS and DMLS technology is performed with one-pitch-segments (1/128 of the tread ring), which are shown on Fig. 6.



Fig. 6. The one-pitch-segments made by SLM, SLS and DMLS technology.

Materials

Materials used for building the tread ring segment are the latest member to the family of metals for use with the SLM, SLS and DMLS systems and have the best properties among the available metal materials for these technologies. Selected materials are 1.4404 (316L) stainless steel metal powder (SLM), Laserform A6 (SLS) and Direct Steel H20 (DMLS).

- 316 L is stainless steel metal powder of single composition. No heat treatment or infiltration of other material is required. The variety of possible used powder materials which are commercially available is one of the very important advantages of SLM process. The material powder pallet started from aluminum, zinc, bronze, over high grade steel powders, titanium, chromium-cobalt, silicon carbide up to the tool steel powder.
- Laserform A6 is polymer (binder) coated steel powder. During the build process the binder is sintered. The resulting part is exposed to a 24h furnace cycle, where the binder is burned off and bronze is infiltrated into the part. As a result, the metal prototype with 80 % stainless and 20% bronze is obtained.
- Direct Steel H20 is a very fine grained steel-based metal powder with properties similar to conventional steel tool. As a result, after sintering we obtain alloy steel prototype containing Cr, Ni, Mo, Si, V, and C.

Important information for the application study is the material costs. Here is material price ratio based on data that has come down from 2006: 1(SLM): 1.96(SLS): 2.31(DMLS).

Machines

Machines used for making these segments were:

- SLM - MCP Realizer^{SLM} with Nd: YAG laser 100W.
- SLS - Vanguard HS with CO₂ laser 100W.
- DMLS - EOSINT M270 with Yb fiber laser 200W.

4.1.1 Utilization features of mould segments made by SLM/SLS/DMLS

Density

Density is measured using a test cubes. Results of density are shown in Table 4. It should be noted that the porosity of the segments is not necessarily disadvantage. To some extent, porosity can be useful if it provides a better, i.e. thorough ventilation of the mould in the process of vulcanization.

Surface roughness

Surface roughness directly affects on tyre appearance and wear resistance. In addition, surface roughness of tread ring segments affects on mould durability and its maintenance costs. Surface roughness was measured by Mitutoyo surfstest SJ-301 (Fig. 7).

The obtained values of surface roughness for the one-pitch segments are shown in Table 4.

The results of measurement show that SLM segment has poor surface quality:

- The values of roughness on vertical surfaces are in range of 20µm to 50µm.
- The roughness of tread ring bottom surface, which is almost horizontal, is out of the measuring range.

- The slanted lateral sides of the mould ridges show staircase structure and inappropriate surface roughness of $75\mu\text{m}$.

Considering that mould segment requires a good surface quality and a very good accuracy SLM segment needs more than five hours of post processing.

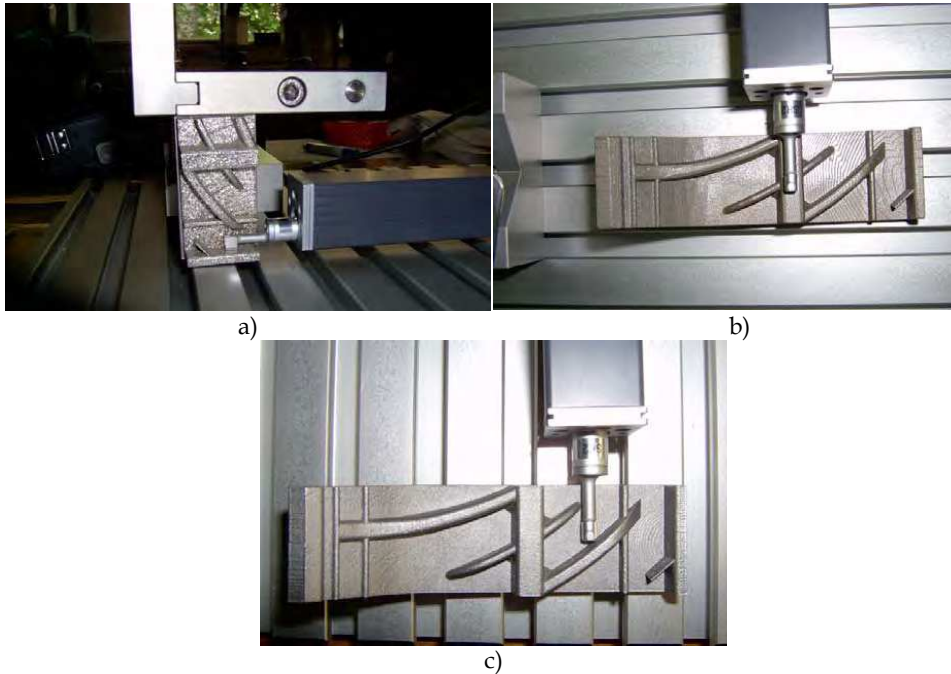

Fig. 7. Surface roughness measurement; a) SLM segment - measurement in slanted lateral side of central ridge region; b) SLS segment - measurement in circular ridge region; c) DMLS segment - measurement in tread ring bottom surface region.

Hardness

Hardness is measured using Rockwell and Brinell device. Results of hardness are shown in Table 4.

Results show that the segment made by DMLS technology has significantly higher values than SLS and SLM segments. All segments can be heat treated and increase those values if necessary.

Geometrical accuracy

One of the most important issues is the geometrical i.e. dimensional accuracy of the segment. This is especially significant according to the fact that accuracy here is maintained on large difference in dimensions between the smallest and biggest geometrical features.

Considering the importance of this parameter, the accuracy of the model is diagnosed in two ways. The first approach is based on geometry comparison between the native CAD

model, which was the input file for the RP machines, and the healed CAD models (Fig. 8). These healed models were reversely designed from scanned metal segments (SLM, SLS and DMLS).

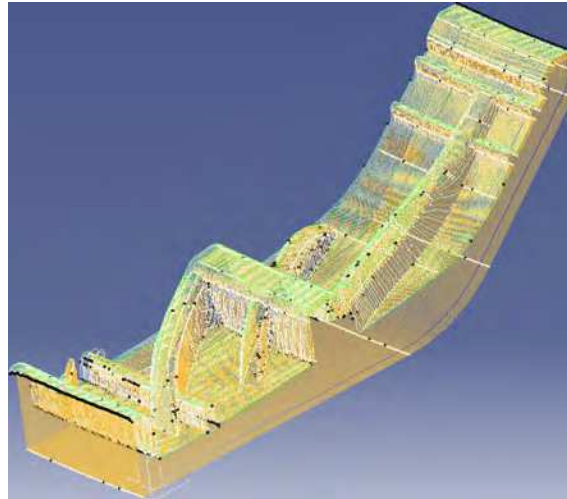

Fig. 8. Comparison between the native CAD model versus scanned metal segments.

The second approach of geometrical accuracy analysis employs Steinbichler optical measurement system. The Fig. 9 shows result window of dimensional accuracy for DMLS segment measured by Steinbichler optical measurement system.

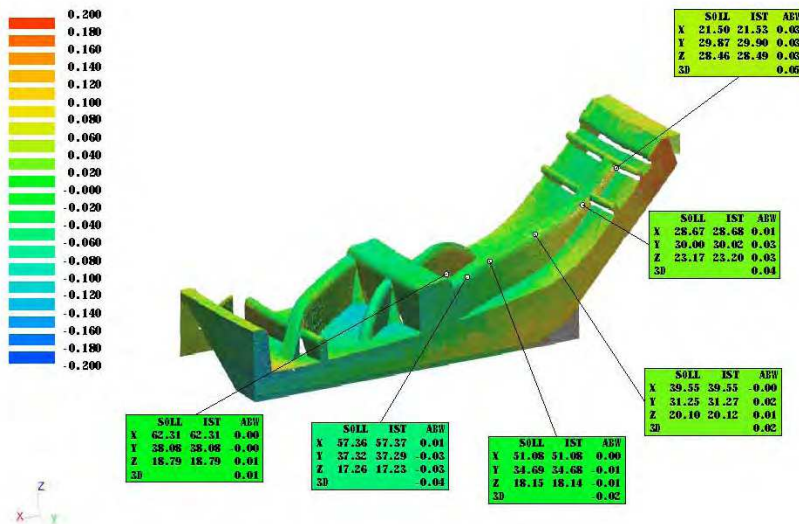

Fig. 9. Geometrical accuracy of DMLS segment.

The results of accuracy for SLM, SLS and DMLS segments ($\approx 88 \times 33 \times 25$ mm) are shown in Table 4.

Manufacturing time and post processing

Manufacturing time and post processing are parameters which have a very important role in determining whether these technologies are competitive to conventional technologies or not. The shortest manufacturing time (including post-processing) is needed for the DMLS segment (Table 4).

<i>Method</i>	<i>SLM</i>	<i>SLS</i>	<i>DMLS</i>
Density	97%	99.5%	98%
Surface roughness	Rz = 20 - 50 μm without any post treatment	Ra \approx 5 - 9 μm Rz \approx 16.60 μm - 35 μm without any post processing Ra \approx 4 μm after polishing	Ra \approx 3.78 - 5.60 μm Rz \approx 16-25 μm after shootpeening. Ra \approx 1 μm after polishing
Hardness	72 HRB 130 HB	89 HRB 180 HB. It can be significantly increase by heat treatment	34 HRC 319 HB
Accuracy	0.10 mm	0.120 mm	0.05 mm
Manufacturing time	15h	3-4h + 24h	14h
Post processing	Because of very poor surface finish at least few hours of polishing.	Necessary - at least one hour of polishing	Sawing from building platform, support removal, shotpeening (30 min)

Table 4. Utilization features of mould segments made by *SLM*, *SLS* and *DMLS*.

The general comparison between technologies which were the subject of this experimental study is shown in Table 5.

<i>RP technology</i>	<i>Geometrical accuracy</i>	<i>Hardness</i>	<i>Surface roughness</i>	<i>Density</i>	<i>Chemical reactivity</i> ⁷
SLS	Appropriate	Acceptable	Acceptable	Acceptable	Reactive
DMLS	Appropriate	Appropriate	Appropriate	Appropriate	Non-reactive
SLM	Appropriate	Appropriate	Coarse	Appropriate	Non-reactive

Table 5. Final comparison table.

⁷ In the specific case of tyre vulcanization environment.

According to the results of measured parameter, it can be concluded that DMLS technology shows better results than SLS and SLM in all relevant areas (hardness, accuracy, surface finish, manufacturing time, post processing time). Considering this DMLS appears to be the most appropriate alternative to the conventional manufacturing methods.

In order to obtain results for other features of DMLS segment (temperature and pressure endurance, thermal conductivity, wear resistance and chemical reactivity) a test tread ring was assembled in which one of its segments was DMLS segment. The test mould was exposed to the real conditions in standard vulcanization process cycle. The results of the test demonstrated that the DMLS one-pitch-segment fulfills this set of utilization features, too.

5. Application study – Tooling issues

Even though DMLS segments that are sintered by DMLS fulfill all the utilization features, still tooling strategy and related economic issues remain to be considered. Generally, there are two different tooling strategies, which can utilize DMLS for tyre tread ring fabrication: fully-direct strategy and semi-direct strategy (Milovanovic et al., 2009).

5.1 Fully-direct rapid tooling strategy

This production strategy anticipates direct laser sintering of large segments or one-pitch-segments of the tread ring. In addition, this RT strategy appears to be the simplest and the most flexible. Low speed of volume sintering (about 1650 mm³/h) makes this RT strategy economically unacceptable for the particular case of tread ring volume. Results from case study showed that DMLS system can make 16 one-pitch-segments for 150 working hours. Considering that one tread ring usually includes 128 one-pitch-segments fully-direct RT strategy needs 1200hr of DMLS.

In order to be competitive to CNC direct engraving, fully direct RT should be much faster process (no more than 240 hours), and costs should not exceed the costs of the production mould (12000\$).

Another important shortcoming of fully-direct RT strategy is the high price of H20 steel powder. Material costs of H20 increase total production costs cumulatively. In the case of rapid tooling of prototype mould by DMLS, economic indexes are better.

5.2 Semi-direct strategy

The so-called semi-direct tooling strategy does not aim to utilize DMLS for direct fabrication of tread ring or its segments. This strategy attempts to optimize DMLS utilization in order to get the very best of the technology (easiness to plan the production process and manufacture complex geometry, fulfillment of utilization features) and, at the same time, to reduce the costs by reducing volume to sinter (reducing the time and usage of expensive material consequently).

Semi-direct RT strategy employs DMLS technology for sintering the form of tyre tread segments, so called *master models* (Fig. 10).

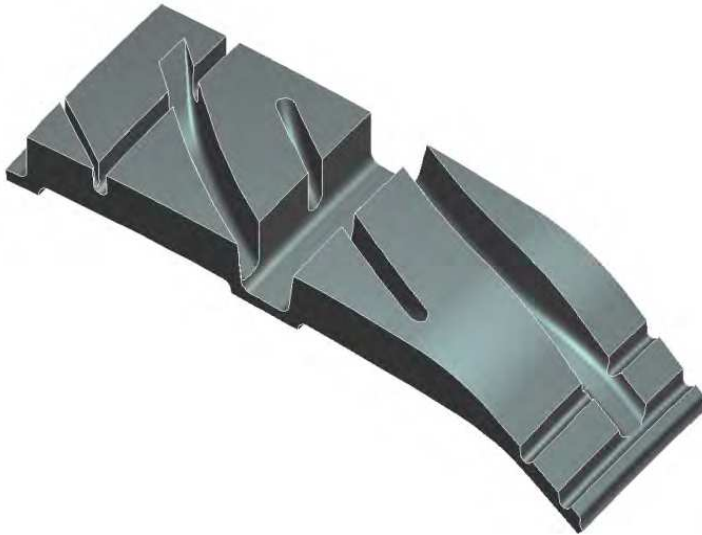

Fig. 10. Sintered master model of the tyre tread pitch.

After the post processing (removing from platform, cleaning and shotpeening as well as additional machining), the master model is used as an insert for die-casting (Panjan et al., 2005) of the AlSi tread ring segments. The next step is die-casting of the aluminum one-pitch-segments of the mould as it is shown in Fig.11 and Fig. 12.

After casting of the one-pitch-segment of the mould (Fig. 13), it is necessary to post-process it by removing the gates, runners and burrs.

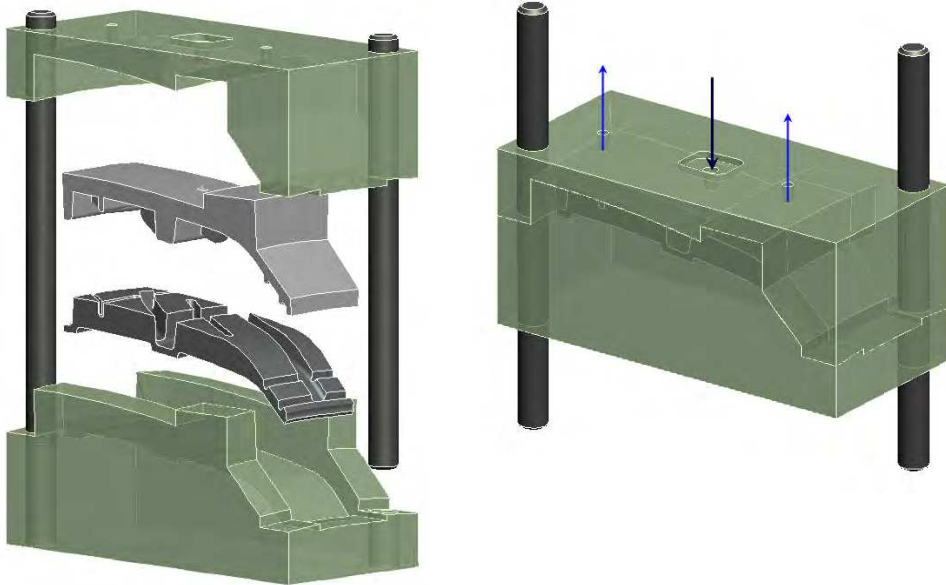

Fig. 11. Die-casting mould.

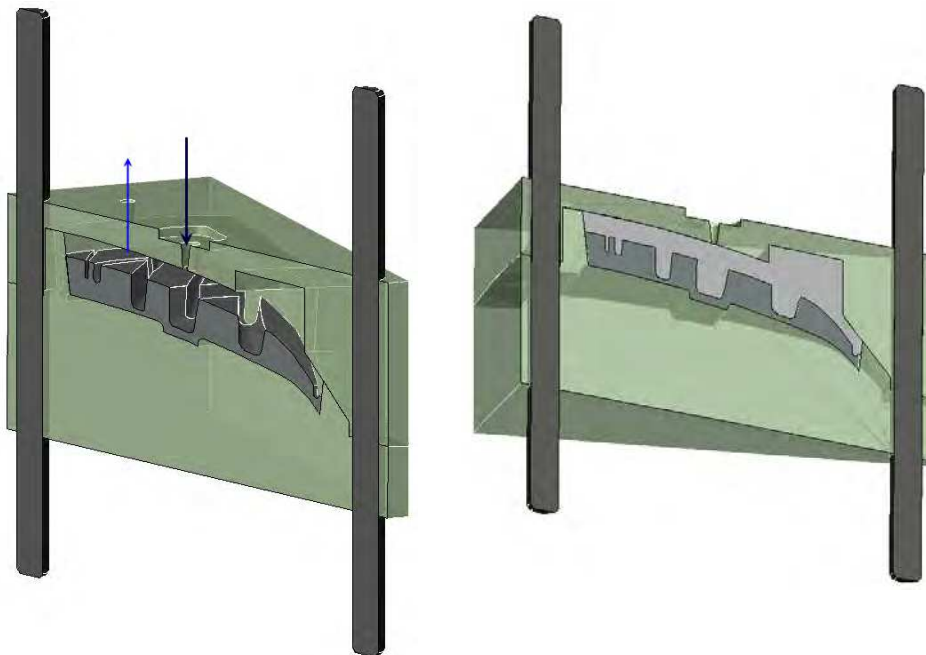

Fig. 12. Die-casting of one-pitch-segment of tread ring.

Finally, the one-pitch-segments are used to assemble the tread ring of the tyre vulcanization mould (Fig. 14). In this tooling strategy, the tread ring is assembled from AISi one-pitch-segments as a large jig-saw puzzle tool, thus the utilization features are the same as they are for the tread rings that are produced by conventional three-steps casting procedure.

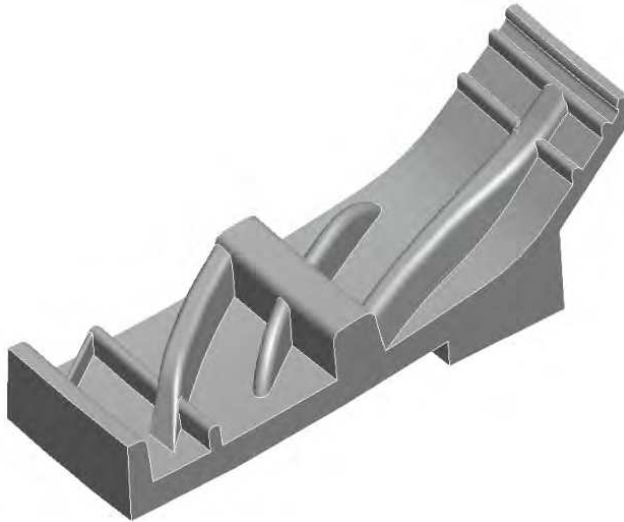

Fig. 13. Casted one-pitch-segment of tread ring.

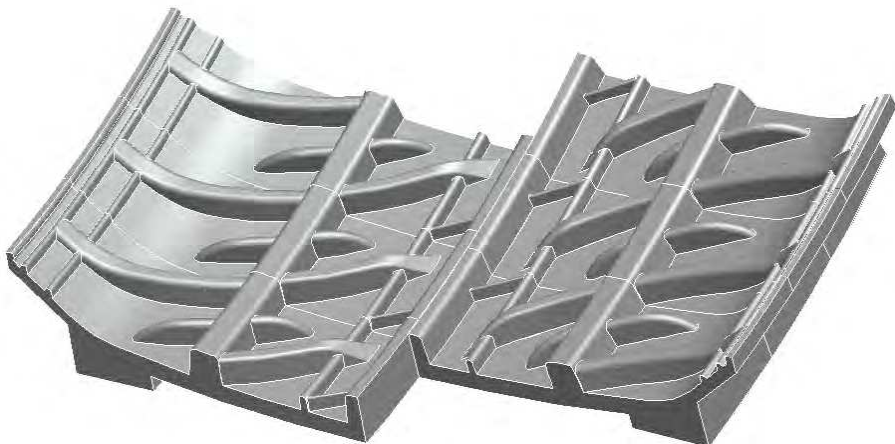

Fig. 14. Assembly of one-pitch-segments makes tread ring (segments).

5.2.1 Limitations on semi-direct RT strategy

Considering that the tread ring of the tyre vulcanization mould is of toroidal shape, it is very difficult to cast larger segments of the ring. If the segments are large (like 40° or 1/9 segments), the surfaces of the ribs that are presented at the tread ring are more slanted. This can cause opening of the mould impossible. Another constraint, which prevents from casting larger segments of the tread ring, is very specific disposition of the so-called pitches of the tyre tread. Usually, tyre tread has three or five different types of pitches that are characterized by slightly different geometry (Stojkovic & Trajanovic, 2001; Stojkovic et al., 2003; Stojkovic et al., 2005a, 2005b; Chu et al., 2006; Lee, 2008). These different pitches are repeated on the tyre tread by very specific disposition. Actually, this disposition has crucial influence on tyre vibration and noise (Sandberg & Ejsmont, 2002). Thus it is economically inappropriate to cast several different larger segments that include different combination of pitches. In addition, the larger segments take more metal powder and more production time, which finally affects on the higher production costs for material and maintenance of the RP system. In the case where it is necessary to produce 360 of 1/9 segments of tread rings (average series of 40 tyre moulds with 9 segments), the costs become unacceptable. The optimal solution is tread ring assembled from one-pitch-segments, where each mould segment corresponds to appropriate tyre tread pitch.

5.2.2 Time and costs consideration

The time and costs in semi-direct RT strategy are much more reduced as compared to the fully-direct strategy. In the case of five different pitches, DMLS system sinters them for about 50 working hours (Table 6).

	Sintering of 1 one-pitch-segment	Post-processing time for 1 one-pitch-segment	Set of 5 one-pitch-segments
<i>Time (min)</i>	600 (10h)	30	3150 (52,5h)
<i>Processing cost ⁸(\$)</i>	120	30	750

Table 6. Time and costs for direct metal sintering of one-pitch-segments.

After the post processing of five master models, that takes 3h, 5120 of AlSi-alloy segments (128 jigsaw puzzles × 40 moulds) is moulded in fast die-casting process (Table 7).

	1 segment ($V \approx 21 \text{ cm}^3$) ($m \approx 59 \text{ g}$)	Segment post-processing (removing the gates, runners and burrs)	128 segments (one mould set)	5120 segments (set for series of 40 production moulds)
<i>Time (min)</i>	0.35 ⁹	1.45	230	9200
<i>Processing cost (\$)</i>				≈ 6000

Table 7. Time and costs for die-casting of series of mould segments.

⁸ Processing cost does not include H2O material costs.

⁹ The time for die-casting of five puzzles is 22 sec., in the tool that has 5 nests.

Duration of the die-casting process depends on number of the nests in the die as well as on the number of available die-cast machines. Whatever, we can claim that semi-direct RT strategy could make significant savings as compared to CNC engraving strategy, and conventional CNC-three-step-casting strategy.

6. Conclusion

The results of the first part of application study, in which utilization features were in focus, clearly showed that DMLS is the best choice among other MLS technologies for rapid tooling of the tread ring. The second part of the study, which took into consideration economic issues of tooling process in whole, leads to the conclusion that just small and thin i.e. skinny pieces (small volume and mass) with high complexity of geometry should be considered as candidates for using DMLS. Having that in mind as, well as the size and complexity of the mould, a conclusion was imposed that DMLS in this very particular case is worthwhile to be used just for fabrication of the set of inserts for die-cast mould that will be used for casting of one-pitch tyre tread ring segments. In the comparison to the conventional tooling processes, this, so-called semi-direct RT strategy is more direct, faster, simpler, more accurate and cheaper. At the same time, semi-direct RT strategy that utilizes DMLS technology is the most flexible procedure for manufacturing of prototype tread ring where the design changes are usually frequent.

7. References

- Campanelli S. L.; Contuzzi N., Angelastro A. & Ludovico A. D. (2010). Capabilities and Performances of the Selective Laser Melting Process, In: *New Trends in Technologies: Devices, Computer, Communication and Industrial Systems*, Meng Joo Er (Ed.), 233-252, ISBN: 978-953-307-212-8, InTech
- Chu C. H.; Song M. C. & Luo V. C. S. (2006). Computer aided parametric design for 3D tyre mould production, *Computers in Industry*, Vol.57, No.1, (September 2005), pp.11-25, ISSN 0166-3615
- Ferreira J. C. (2004). Rapid tooling of die DMLS inserts for shoot-squeeze moulding (DISA) system, *Journal of Materials Processing Technology*, Vol. 155-156, pp. 1111-1117, ISSN 0924-0136
- Fleming R. A. (1995). Tyre mould technology in die casting and venting: an overview, *Die Casting Engineer*, Vol.39, No. 5, pp.111-117, ISSN 0012-253X
- Ilyas I.; Taylor C.; Dalgarno K. & Gosden J. (2010). Design and manufacture of injection mould tool inserts produced using indirect SLS and machining processes, *Rapid Prototyping Journal*, Vol.16, No.6, pp.429 - 440, ISSN 1355-2546
- Khaing M. W. , Fuh J. Y. H. & Lu L. (2001). Direct metal laser sintering for rapid tooling: processing and characterisation of EOS parts, *Journal of Materials Processing Technology*, Vol.113, No.1-3, (June 2001), pp.269-272, ISSN 0924-0136
- King, D. & Tansey T. (2003). Rapid tooling: selective laser sintering injection tooling, *Journal of Materials Processing Technology*, Vol. 132, No. (1-3), pp. 42-48. ISSN 0924-0136
- Knedla D. (2000). Tyre moulds: development, production, quality, *Tyre technology International*, pp. 150-153, ISSN 0969-7217

- Kruth J.P.; Mercelis P.; Van Vaerenbergh J.; Froyen L. & Rombouts M. (2005) Binding Mechanisms in Selective Laser Sintering and Selective Laser Melting, *Rapid Prototyping Journal*, Vol. 11, No.1, 26-36, 2005.
- Lee C. S. (2008). Geometric Modeling and Five-axis Machining of Tire Master Models, *International Journal of Precision Engineering and Manufacturing*, Vol. 9, No. 3, pp.75-78, ISSN 12298557
- Milovanovic J. (2006). *Possibilities of using rapid prototyping technologies in tyre mould manufacturing*, MSc thesis, University of Nis, Serbia
- Milovanovic J.; Stojkovic M. & Trajanovic M. (2009) Rapid tooling of tyre tread ring mould using direct metal laser sintering, *Journal of Scientific & Industrial Research*, Vol. 68 No. 12, pp. 1038-1042, ISSN 0975-1084
- Milovanovic J.; Trajanovic M. & Stojkovic M. (2005) Possibilities of using selective laser melting for tyre mould manufacturing, *Proceedings 2nd International Conference on Manufacturing Engineering ICMEN*, pp. 187-193, Halkidiki, Greece, October 05-07, 2005
- Panjan P.; Dolinšek S.; Dolinšek M.; Čekada M. & Škarabot M. (2005). Improvement of laser sintered tools with PVD coatings, *Surface and Coating Technology*, Vol. 200, No. 1-4, (October 2005), pp. 712-716, ISSN 0257-8972
- Pessard E.; Mognolj P. Y.; Hascoët Y. & Gerometta C. (2008). Complex cast parts with rapid tooling: rapid manufacturing point of view, *The International Journal of Advanced Manufacturing Technology*, Vol. 39, No. 9, (November 2007), pp. 898-904, ISSN 1433-3015
- Salaorni E. & Pizzini D. (2000). Constructing a Mould, *Tyre technology International*, pp. 154-158, ISSN 0969-7217
- Sandberg U. & Ejsmont J. A., (2002). *Tyre/Road Noise Reference book*, INFORMEX, Harg, SE-59040 Kisa, ISBN 91-631-2610-9, Sweden
- Simchi A.; Petzoldt F. & Pohl H. (2003). On the development of direct metal laser sintering for rapid tooling, *Journal of Materials Processing Technology*, Vol.141, No. 3, (November 2003), pp.319-328, ISSN 0924-0136
- Stojkovic M. & Trajanovic M. (2001). Parametric design of automotive tyre, *Proceedings of First National Conference on Recent Advances in Mechanical Engineering*, ASME - Greek Section, ANG1/P046, September 17-20, 2001
- Stojkovic M., Trajanovic M & Korunovic N. (2005). Computer Aided Tyre Design, *IIPP Journal*, No.8, year III pp. 19-32 (in Serbian), ISSN 1451-4117
- Stojkovic M.; Manic M. & Trajanovic M. (2005). Knowledge-Embedded Template Concept, *CIRP - Journal of Manufacturing Systems*, Vol. 34, No 1, pp.71-79, ISSN 1581-504
- Stojkovic M.; Manic M.; Trajanovic M. & Korunovic N. (2003). Customized Tyre Design Solution Based on Knowledge Embedded Template Concept, *22nd Annual Meeting and Conference of The Tyre Society*, Akron, Ohio, U.S., September 23-24, 2003.
- Voet A.; Dehaes, J.; Mingneau J., Kruth J. & Van Vaerenbergh J. (2005). Laser sintered injection moulds, case studies made in Belgium, *Proceedings of the International Conference Polymers & Moulds Innovations PMI 2005*. International Conference Polymers & Moulds Innovations PMI 2005. Gent, Belgium, Apr 20-23, 2005

Xu, X.; Sachs, E. & Allen, S. (2001). The design of conformal cooling channels in injection molding tooling. *Polymer Engineering And Science*, Vol. 41, No. 7, (July 2001), pp. 1265–1279, ISSN 0032-3888

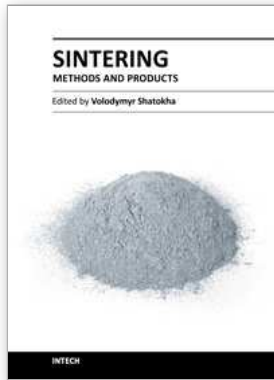

Sintering - Methods and Products

Edited by Dr. Volodymyr Shatokha

ISBN 978-953-51-0371-4

Hard cover, 316 pages

Publisher InTech

Published online 23, March, 2012

Published in print edition March, 2012

This book is addressed to a large and multidisciplinary audience of researchers and students dealing with or interested in sintering. Though commonly known as a method for production of objects from fines or powders, sintering is a very complex physicochemical phenomenon. It is complex because it involves a number of phenomena exhibiting themselves in various heterogeneous material systems, in a wide temperature range, and in different physical states. It is multidisciplinary research area because understanding of sintering requires a broad knowledge - from solid state physics and fluid dynamics to thermodynamics and kinetics of chemical reactions. Finally, sintering is not only a phenomenon. As a material processing method, sintering embraces the wide group of technologies used to obtain such different products as for example iron ore agglomerate and luminescent powders. As a matter of fact, this publication is a rare opportunity to connect the researchers involved in different domains of sintering in a single book.

How to reference

In order to correctly reference this scholarly work, feel free to copy and paste the following:

Jelena Milovanovic, Milos Stojkovic and Miroslav Trajanovic (2012). Metal Laser Sintering for Rapid Tooling in Application to Tyre Tread Pattern Mould, Sintering - Methods and Products, Dr. Volodymyr Shatokha (Ed.), ISBN: 978-953-51-0371-4, InTech, Available from: <http://www.intechopen.com/books/sintering-methods-and-products/metal-laser-sintering-for-rapid-tooling-in-application-to-tyre-tread-pattern-mould->

INTECH
open science | open minds

InTech Europe

University Campus STeP Ri
Slavka Krautzeka 83/A
51000 Rijeka, Croatia
Phone: +385 (51) 770 447
Fax: +385 (51) 686 166
www.intechopen.com

InTech China

Unit 405, Office Block, Hotel Equatorial Shanghai
No.65, Yan An Road (West), Shanghai, 200040, China
中国上海市延安西路65号上海国际贵都大饭店办公楼405单元
Phone: +86-21-62489820
Fax: +86-21-62489821

© 2012 The Author(s). Licensee IntechOpen. This is an open access article distributed under the terms of the [Creative Commons Attribution 3.0 License](#), which permits unrestricted use, distribution, and reproduction in any medium, provided the original work is properly cited.