

Round Wood Measurement System

Karel Janák
*Mendel University Brno,
Czech Republic*

1. Introduction

The roundwood volume is one of basic parameters at its sale and purchase being indispensable operational information of every saw mill. The tree stem or its part (log) is an irregular body the form and volume of which can be determined by simple operational procedures only approximately. According to possibilities of measurement (conditions, equipment, time consumption etc.), methods of calculation and approach to problems more procedures have been proposed to determine the volume of roundwood. Many of these methods and procedures are used today. In Central Europe, Huber method became most widespread for manual measurements in the forest. The method compares the tree stem to a cylinder. The main advantage of this method consists in the low demands of measurements (diameter - 2 times perpendicular at each other under bark /u.b./ in the centre of the log length, diameter and length accurate to whole centimetres), easy practicability, no special equipment and sufficient accuracy.

Lines in log yards of present processing plants are ordinarily equipped with optoelectronic sensors and control systems evaluating virtually continuously the roundwood diameter (by at least 10 cm length) accurate to ± 1 to ± 2 mm and length accurate to ± 1 cm. Also at the electronic measurement and calculation of the log volume on the basis of electronic measurements more procedures are used. Due to results in the determination of a mid diameter or volume electronic procedures are not even consistent with manual methods or with each other and their results do not correspond even to the geometric volume of logs. Different results of measurements are often the reason of doubts about the accuracy (rightness) of measurements reflecting also relationships between suppliers and processors of wood.

The aim of the presented paper is the description and analysis of currently used principles of sensing and evaluating the roundwood volume in Central Europe as well as quantification of deviations, which originate due to the use of various method of the determination of roundwood volume at the simultaneous determination of deviations on basic parameters of roundwood (diameter and length). Thus, the paper outlines possibilities to compare results determined according to different procedures.

The paper tries to describe comprehensively problems of sensing and evaluating the roundwood dimensions in order mutual relations to be obvious. In the descriptive part, it deals with methods of sensing the log diameter and length, which are used in Central Europe today. The paper mentions also main rules and regulations, which are related to the

measurement and reception of timber. It stems from the author's survey of using sensing and evaluation systems in the Czech Republic and literature data on these problems in surrounding countries (mainly Austria, Germany and Slovakia).

In the analytical and result part, a general algorithm is derived of processing sensed data. Steps are determined leading to different results of particular regulations. The results are compared with results of a method, which tries to evaluate the volume of logs (closest to the geometrical volume) from data taken by systems used at present. In relation to the volume determined in this way properties of existing procedures are also mentioned.

At the end, the paper indicates directions for the further progress of research and agreements as well as legislative regulations with a view to minimize differences in the measurement and determination of the volume of roundwood.

2. Round wood

Dimensions and volume of wood together with its quality are basic data accompanying wood from the stage of a young stand until the end of the wood product service life. In many cases, it is sufficient to know only approximate values of dimensions and volume, e.g. growing stock, the volume of cut, and roundwood supplies on log yards. On the other hand, operations controlling production or where wood is the subject of business – goods, are sensitive to accuracy.

The tree stem or its part, log, is a body, the form of which is mostly compared to a truncated cone, paraboloid or cylinder. However the real form does not correspond to any regular geometric body. Moreover, it is affected by considerable individual diversity given by the tree species, tree age, site, tree position in the stand, care of the stand, type and extent of attack, mechanical damage either natural or caused by man activities and many other effects. From the aspect of dimensions, these effects become evident in various taper, sweep, flattening, root swelling, buttress, burrs and cracks. Production defects of wood are represented by remains of branches and damage to the stem surface at branching and handling, chamfer cuts, hinges (holding wood) after cutting or bucking (cross-cutting), cracks etc. All these properties have to be taken into account at stem or log measurements and at the evaluation of their dimensions and volume. Bark – its thickness and condition, represents a separate problem at the measurement of wood.

3. Ways of dimension scanning

Measurements and methods of their implementation are given by the need of data on wood (in which moment, type of data and satisfactory accuracy) and by the technical and practical feasibility of measurements.

According to the type of manufacture determined for the wood, mass measurements of logs are sufficient (production of agglomerated materials, paper, and cellulose) or it is necessary to measure parameters of particular logs separately (production of sawn wood, veneers). At mass measurements, a basic parameter consists in the total volume of supply; extents of the diameter and length of logs are usually only complete data. Volumes, dimensions and often even the number of particular logs are not recorded at these types of production because they are not decisive.

At the measurement of particular logs we need to obtain following data:

- The log length - according to the length, the following processing the stem is determined. It also serves for classification and calculation of the volume of logs for production and commercial purposes.
- The log diameter in the length centre - it serves for the approximate log volume calculation (at the majority of methods /not exclusively/).
- Log diameter at its top end - it is decisive for the way of log processing, serves for the subsequent classification of logs. For the volume calculation it can serve in cases when the log centre is not available, e.g. at log yards. However, results obtained in this way are less accurate.
- Log diameter at its butt end - it is decisive from the aspect of the line passage (clearance of subsequent machines)
- A diameter continuously along the whole log length - it is necessary for subsequent processing - cross-cutting. The result of measurement consists in the suitable place of cross-cutting (necessary length and top end diameter), removal of defects, and the highest yield.

Dimensions and volumes of particular stems (logs) have to be known already in place of felling, at the latest in places of skidding before the wood haulage from forest (cut records, output of workers and their remuneration). If felling is carried out manually by one-man chain saws then means used for measurements are usually simplest, namely a calliper and tape.



Fig. 1. Electronic calliper with a tape.

Manual measurement and its unpretending equipment is quite satisfactory from the aspect of the accuracy of its results (units - cm) and possibilities to carry out subsequent cross-cutting tree-length logs. Values of diameter and length create, at the same time, basic data for records and calculations of volumes. It is usually determined according to tables. Thus, the

accuracy of the measurement of the diameter and length of tree-length logs in the field gives generally the accuracy of values of dimensions and volume of logs given on bills of delivery.

Harvesters are equipped with electronic (electromechanical) scanning systems. Attainable accuracy of the measurement is higher (units – mm). However, results of measurements are substantially dependent mainly on the pressure of particular parts of the scanning equipment (delimiting knives or feeding cylinders). Values of these parameters change continuously according to conditions of felling (tree species, dimensions, and season). Therefore, results of measurements at these systems have to be continuously checked and revised (even several times per shift).

The stem diameter is scanned according to the deviation of delimiting knives or the deviation of arms of feeding cylinders. At scanning by means of delimiting knives (see Fig. 2), the angle of the deviation of two knives which press the stem to the third stable knife is scanned (the third point necessary to define a circle and the subsequent calculation of its diameter). At the measurement by means of feeding cylinders the deviation of arms usually of 3 feeding cylinders is scanned. These cylinders press the stem with each other (3 points of a circle are obtained on principle according to the figure) or a couple of conical cylinders placed against each other (the diameter is scanned directly). The deviation of cylinders is usually scanned by an induction sensor or potentiometer. The stem length is scanned by a pinion (sprocket) pressed to the stem surface during its movement. Turning the pinion is sensed by an impulse generator. Scanning directly by feeding cylinders is not used because at high loading (stem start, delimiting), the slippage of cylinders occurs on the stem surface. Errors resulting from the different length of the stem surface curve and its length are negligible.



Fig. 2. Photo + scheme of scanning the stem diameter and length at harvesters (both figures according to Ponsse).

Log yards of forest enterprises and wood processors are equipped with cross-cutting-sorting carriages (all round cars) or lines. The equipment serves for the preparation of supplies of logs to manufacturing plants or for the preparation of logs according to requirements of subsequent production (With respect to the increasing proportion of harvester logging

/generally/ the importance and number of log conversion depots declines). Scanning equipment for the log diameter and length is always part of the equipment. At scanning the log diameter, the number of taken values of the log diameter in one place of length, direction of scanning, accuracy and density of scanning in the course of length are essential.

One-directional way of scanning - 1D takes the value of the log diameter in one, usually vertical direction. As for possible technical designs, measuring frames are used nearly exclusively. The principle of scanning indicates a scheme on Fig. 3.

One-directional scanning is not able to record the log flattening and only very roughly the log curvature.

Using 1D scanning devices for the purpose of electronic reception is, therefore, unsuitable and results are affected by relatively considerable errors.

Bi-directional measuring (2D) is carried out by two systems perpendicular at each other and placed in one frame. It can be installed in such a way one scanning to proceed in vertical direction and the second scanning in horizontal direction or both measurements perpendicular at each other to proceed at an angle of 45° with respect to a horizontal level.

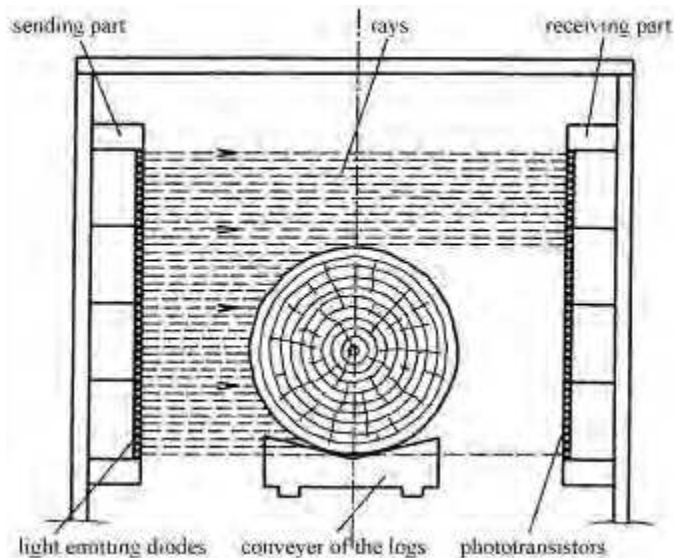

Fig. 3. The principle of scanning the log diameter by a one-directional scanning frame.

The substantial advantage of 2D scanning consists in the better record of the measured log form and thus a possibility to calculate objective values of the log diameter in the place of measurement. The evaluation of stem curvature (sweep) is markedly more accurate. To calculate the log volume both methods of placing the sensing elements are equivalent. However, vertically and horizontally oriented sensors record flattening of the measured logs better - a flattened log shows a tendency "to lie down flat" on the conveyor, i.e. vertically measured diameter shows a smaller value than a diameter measured horizontally. At systems oriented at an angle of 45° this difference disappears and both data approach the average value of log diameter in a given place.



(a) vertical and horizontal position of scanning systems (b) placing the scanning systems at an angle of 45°

Fig. 4. 2D measurements by a scanning frame. Both systems are placed in one frame. The conveyer can come through the place of measurement (a) or it is interrupted (b).

From the aspect of taking log diameter it is better when the conveyer is interrupted in the place of measurement. Thus, measurements are not affected by “erroneous” data caused by the transport track and passing drive dogs, which have to be subsequently filtrated by special program equipment. However, from the aspect of scanning the log length and mainly evaluation of the stem curvature (generally form) change of the log position on the conveyer is “more dangerous”. It will be recorded by the sensing device as a change in the diameter position; however, the sensor is not able to differentiate if it was caused by the log curvature or by the change of its position on conveyers. Unfortunately, the conveyer interruption supports the change of the log position.

Scanning the peripheral curve (3D measurements) makes possible to scan the whole form of the log cross-section in the measured place. There are more principles of scanning and at some equipment, they are also combined. Usually, an intensive narrow light line is projected on the log in the place of measurement perpendicular to its axis. The light “cross section” is subsequently taken by cameras. Based on their signal, the form and position of the cross section is constructed and the area centre is evaluated. Subsequently, distances are evaluated of opposite points (i.e. log diameter) usually at least in an interval of 5° (36 values of the log diameter). Changes of the cross section position in the course of scanning of the whole log length make possible to evaluate the stem curvature and form anomalies.

The accuracy of diameter scanning ranges usually within the limits ± 1 to ± 2 mm. Values of diameter are evaluated usually at 10 cm intervals of the measured log length.

Systems for scanning log lengths were reduced in the course of development, namely to a laser system using the phase shift between the sent and received ray of laser and a system with a pulse generator and a photocell. The second system is used in the majority of cases in Europe. In the Czech Republic, the system is used exclusively.

The drive of a pulse generator is derived from the conveyer drive. The conveyer wheel diameter, gear ratio, and the number of pulses generated by the generator per one

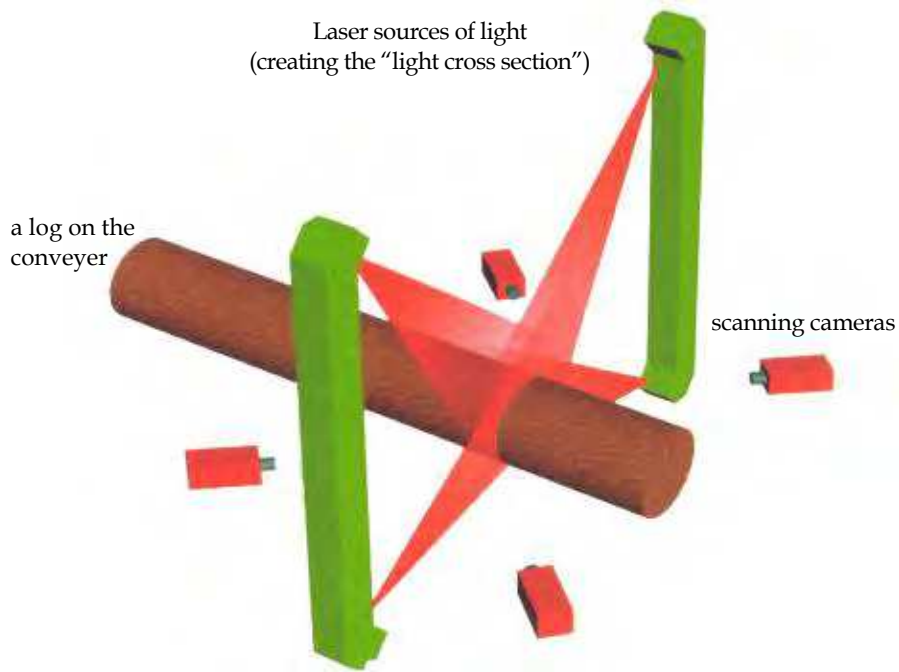

Fig. 5. The lay-out of a configuration for scanning the surface curve (3D measurement) (according to Microtec).

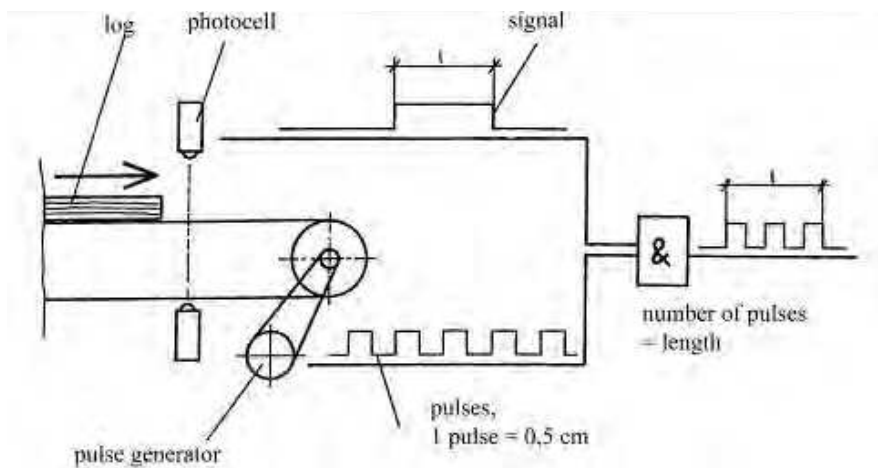

Fig. 6. Principles of measuring the log length by means of a pulse generator and a photocell.

revolution gives the number of pulses per the conveyer line unit. A log moving on a conveyer cuts across the photocell ray and during its shading the photocell sends a signal. The number of pulses sent by the generator during the photocell shading gives the log length. Accuracy reached by this method of measurement ranges from ± 1 to ± 2 cm. Advantages of this method consist in its simplicity, reliability and non-sensitivity to the conveyer speed and its changes during measurement. Disadvantages consist in the photocell sensitivity to defects on the log end (chamfer cut, torn up fibres). Thanks to this fact, the system has a tendency to give excess values at logs with these defects. Erroneous measurements are also caused by the log shift on a conveyer.

Data on dimensions and shape of logs are also provided by scanners working on the principle of absorption of microwave radiation. Systems equipped with these scanners are primarily determined for scanning quality. Many defects (rot, knots, and growth anomalies) are often not visible from the stem surface being not noted at the visual checking the quality. Evaluation of scanned data at this method of scanning is however, substantially more complicated with respect to mutual relationships of more values (dimensions, density, moisture etc.). Thus, they are not used only for scanning dimensions due to their demands and costs.

4. Processing the scanned data

Dimensions and volumes of logs corresponding "exactly" to their geometrical properties cannot be, naturally, determined in operation. Every determination of the log volume based on the calculation of the volume of geometrical bodies (cylinder, truncated cone, paraboloid etc.) represents only approximation to reality but not its expression. A value achieved by this way represents a nominal "commercial" volume of wood. According to the technical feasibility of measurements under given conditions, availability of means necessary for measuring, requirements and experience of the result users and according to "historical" usage in the given region, many methods of measurements and processing the scanned data are used in Central Europe at present. Any used procedure cannot be considered to be unequivocally bad. Thus, unification of the method of wood measurement, at least in the area of Central Europe, does not appear to be realistic. Therefore, it is necessary at least to recalculate results achieved by particular procedures with each other. Unambiguous recalculation is not possible because at processing results of measurements it is necessary to use statistical methods. Under conditions of Central Europe, the volume of logs is usually given in m^3 under bark (u.b. volume). It is calculated as the volume of a cylinder, the length of which is equal to the nominal length of logs and diameter corresponds to the mid diameter of logs (u.b.).

The log volume calculation as the volume of a cylinder stems from a historical method, which was proposed by a Bavarian forest inspector Franz Xaver Huber in 1825 on the basis of his theoretical analyses and long-time experience. Owing to the simple feasibility of measurements and the method of calculation as well as due to the sufficient accuracy of results, the method was soon used not only in Bavaria but in whole Germany, Austria-Hungary, and in the course of time also in a lot of other European countries.

Simplification of the log form causes that the method of Huber gives generally lower volume compared to reality providing satisfactory results only for the wide average of the large number of logs but not for particular logs. Accuracy of the measurement depends

mainly on the stem part, which was used for the log production. The method undervalues the volume of butt logs while top logs are overvalued. F.X. Huber was aware of this fact and, thus, for more accurate measurements, he recommended a section method. This method divides a stem to 1 or 2 m long sections and the volume of each of the sections is calculated separately using the way described above. The volume of a log is then the sum of volumes of particular sections. At the time of its origin, the method was used only for research operations due to its excessive time consumption. Due to similar causes even other procedures requiring more measurements were not used later in practice.

Procedures used at present for wood measurement and determination of its volume (from the aspect of their user in Czech Republic) are as follows:

- Recommended rules for the measurement and classification/grading of wood in the Czech Republic, 2008 (Kolektiv, 2008)
- ÖNorm L 1021 Vermessung von Rundholz, Austria, 2006 (Österreichisches Normungsinstitut, 2006)
- Rahmenvereinbarung für die Werksvermessung von Stammholz, 2005 (Deutscher Forstwirtschaftsrat e.V. & Verband der Deutschen Säge- und Holzindustrie e.V., 2005)

Besides, there is a European standard EN 1309-2 Roundwood and sawn timber – Methods of measuring dimensions - Part 2: Roundwood – Requirements for measurements and rules for the volume calculation, 2006. Although it concerns a relatively new European standard, its use has not been found out in the CR. Its use (anywhere) limits not quite unambiguously determined methods of the determination of a mid diameter. A normative supplement B evokes also certain confusion. The normalized procedure of measurement is presented here as “rules for the measurement and calculation of the log volume valid if there are no state, regional or district rules”.

For users in Czech countries, it is suitable to include (from practical aspects) the CSN 48 0050 Standard “Raw timber. Basic and common provisions” into the survey of rules (ČSN 48 0050, 1992). This standard was used in the Czech Republic until the publication of “Recommended rules 2002”. At present, it is not legally binding being virtually not used for timber reception. The majority of users are accustomed to results of measurements carried out according to the standard. The users compare often values obtained according to other rules with its results. Moreover, results of measurements carried out according to this standard were in very good agreement with reality.

The analysis of methods of measurements includes all regulations and rules mentioned above talking into account also variants, which are determined or admitted by these regulations. It refers to following variants:

- Recommended rules for the measurement and grading of timber in the Czech Republic 2008 determine separate procedures for manual and electronic measurements, which are not quite identical.
- ÖNorm L 1021 Vermessung von Rundholz makes possible calculations from mid diameter values given in mm or converted to cm in such a way that units in mm are not taken into account. The use of diameter values in cm is preferred.
- Rahmenvereinbarung für die Werksvermessung von Stammholz gives mid diameter and subsequent calculations of the log volume differently in the extent of log diameters up to 20 cm and from 20 cm.

- The CSN 48 0050 Standard “Raw timber. Basic and common provisions” determines different procedures for manual and electronic measurements.

A detailed analysis in the previous determination of procedures and their variants (which does not include all European regulations) has shown that it is possible to analyse them to common elementary steps. Not all steps prescribe all procedures and the method of implementing many steps is different. However, by the exact definition of particular steps, all procedures can be unambiguously and fully characterized (see Fig. 7).

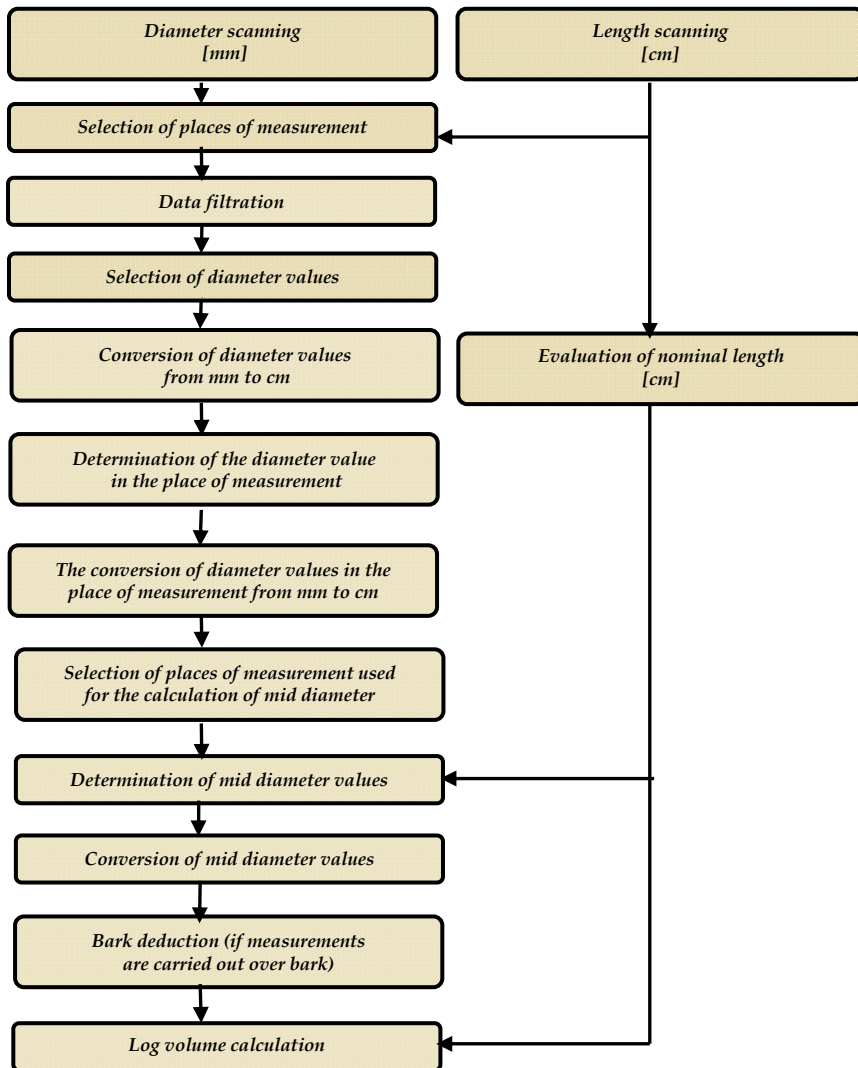

Fig. 7. Elementary steps at scanning and evaluation of dimensions and volume of logs and their sequence.

The way of carrying out particular steps is given in table 1. Variants of the implementation of particular steps (if they are determined or made possible by regulations) are given as separate procedures.

A step, which is consistently ignored by all regulations, is filtration of data. The aim of filtration is to create the stem image, which approaches maximally its actual/real form. It removes error data replacing them by probable data. Extreme values are considered to be "erroneous". These data originate usually by tattered parts of bark, wood, remains of branches etc. These values are replaced (at filtration) by values, which level the form of a log in such a way to correspond (ie with higher probability) its real form.

In addition to defects on the wood surface, filtration is inevitable at systems with a through-way conveyer to filtrate parts of the conveyer (usually driving dogs/carriers and their guide).

At manual measurements, a principle can be considered to be a certain form of filtration, which says that if there is a defect in the place of measurement (e.g. in the log centre), two measurements are carried out at both sides of the defect where the defect already does not appear. An average value from both these measurements is considered to be a value in the original place of measurement.

Methods of filtration at electronic measurements are based on mathematical and statistical procedures, which are usually combined. Basic used procedures usually are as follows:

- *Moving averages* – serve for the general adjustment of the stem surface curve. To each of the places of measurement (x) a value is assigned calculated as an average from values taken in an interval ($x - n, \dots x, \dots x + n$). In its centre, there is the place of a given measurement. The number of members serving for the calculation of a moving average (smoothing with) is usually odd. The procedure can be also several times repeated (the depth of smoothing), however, there is a danger of too large idealization of the piece (log) form. By means of this method, it is not possible to calculate values for edge places of measurement. At the determination of the log mid diameter for the calculation of its volume, the shortcoming does not appear but when we need to determine top diameter it is necessary to extrapolate it in the course of moving averages.
- *Moving medians* – serve also for the general adjustment. The procedure is analogous the previous method, only the average value is replaced by median. Advantages consist in fact that the resulting value is not affected by potential extremes.
- *Top extremes cutting* – serve to eliminate extreme values with positive deviation caused usually by protruding bark, torn up fibres or parts of branches. More types of methods of the elimination of positive extreme values are used. Nevertheless, they do not suffice alone for the filtration, always follows adjustment using some of other methods.
- *Linear regression* – serves for the total adjustment of the stem surface curve to a straight line by the approximation of given values using the polynomial of the first order (straight line) by the method of least squares. If this procedure is applied directly to measured values, considerably distant values can markedly affect (deviate) the whole line. Its use for the set of values, which were already adjusted by mean of another method, was more suitable.
- *Mutual comparison of values of diameters measured in perpendicular directions* (e.g. horizontally - x and vertically - y) in one place with respect to the log length. Differences in values X and Y are compared with a value higher than common flattening. Effects of flattening can be eliminated comparing several successive values of

the X and Y difference. The flattening becomes evident in the whole length of the log or at least on its longer section. The procedure serves to identify "unreliable values". For their replacement, it is necessary to use another method.

- *Mutual comparison of values of diameters measured successively in one direction.* A difference between X_a and X_{a+1} is compared with the maximum admissible size of a difference derived from the possible stem taper. Similarly as the previous method it serves to identify "unreliable values". The method disadvantage is that it does not find an error which consists in the deviation of more successive values. It is not also utilizable for searching defects at the log end.
- *Comparison of the growth coefficient of successive values,* i.e. the relation of X_a and X_{a+1} with a value derived from a possible taper. Members of the proportion may not be successive measured values. Also this method serves to identify defects and also here it is necessary to determine another method or to change the comparison of data at the end of a series.

To record the majority of described erroneous data but, at the same time, for the realistic implementation of filtration there are usually more suitable combined methods. It is possible to combine both various types of basic methods and their succession and in "moving methods" also the number of values taken into account. At the same time, different methods are used for the filtration of the log central part to obtain mid diameter for the volume calculation (or for cross-cutting) and for the filtration of the log end parts to determine end diameter mainly for the purpose of grading. There, the use of "moving" procedures is very limited.

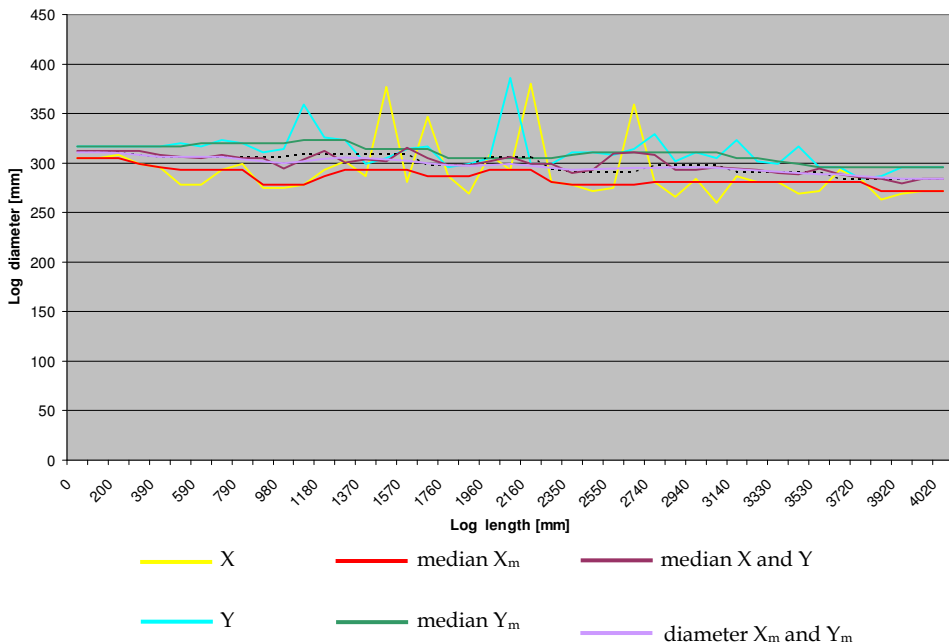

Fig. 8. An example of the effect of various procedures of filtration of scanned data on the resulting image of a log in a control computer (the log shows ragged bark in its central part).

The method of filtration shows substantial effects on values of quantities evaluated in next steps. Different methods of filtration are selected both for various types of sensing devices and assortments of processed raw material. Similarly, it is possible to achieve the required conformity of results of standard measurements with the given reference measurement by the suitable method of filtration. Therefore, manufacturers of sensing (scanning) or control systems use frequently filtration at the final setting the equipment parameters. Thus, it is not possible to define concrete used methods of filtration.

The analysis of particular steps results in the following conclusions:

- methods of the electronic scanning of wood provide very similar data on its geometrical properties,
- methods of the evaluation of electronically scanned data markedly follow the manual method of measurement trying to adapt to its possibilities (number of used measurements, accuracy),
- methods of determination of the stem (log) volume keep the original principle of the log volume calculation as one cylinder although the density of carried out measurements provides the sufficient number of data for the calculation of the log volume according to sections.

Thus, the absence of using possibilities of electronic scanning and evaluation of dimensions, form and volume of wood results in deviations between evaluated (nominal, commercial) volume and real/actual volume.

Differences in the determination of dimensions (above all mid diameter) of logs between particular rules result in differences in the determination of wood volume according to particular rules/regulations. Steps, which cause these differences, are as follows:

- conversion of millimetre values of the log diameter to whole centimetres,
- conversions generally (only exceptional using millimetre values for next calculations),
- the method of conversion (mathematical rounding or removing units in mm),
- the number of conversions (the conversion of particular scanned values and values calculated as an average from values converted to whole cm already previously),
- determination of the place of measuring the mid diameter of logs (centre of the nominal or actual geometrical length including allowances),
- evaluation of the log mid diameter (average value or a smaller value from diameter values determined in both places of measurement within the measuring area in the centre of the log length),
- selection of diameter values (keeping values taken horizontally and vertically /2D equivalent of scanning/ or searching for a maximum) – only at 3D scanning,
- filtration of scanned data (its effect at present valid regulations cannot be determined because the regulations do not define the way of its implementation).

5. Differences in results

Results of measurements and determination of the volume of logs obtained according to rules given in table 1 are compared with the value of a volume, which approaches most the geometrical volume of logs. Calculation of the “geometrical” volume of logs is based exclusively on values scanned on a regular basis according to present regulations. Thus,

The survey of rules and determined methods of the implementation of particular steps										
No.	Rule	Scanning	Filtration	Places of measurement used for the calculation of the log mid diameter	The conversion of measured values in mm to cm	The method of determining the log diameter in the place of measurement	Conversion of the diameter in the value of measuring from mm to cm	The method of determining the log mid diameter	Conversion of the mid diameter value from mm to cm	Volume calculation
1	EN 1309-2 Standard - Roundwood and sawn timber - Methods of dimension measurement Part 2: Roundwood, 2006	2D	not defined	two in the zone of ±10 cm from the centre of a nominal length	mm units are not taken into account (cutting off)	mathematical average from both measurements	mathematical rounding	mathematical average from measured values	mathematical rounding	as the cylinder volume
2	Recommended rules for the measurement and grading of timber in the Czech Republic 2008.	2D	not defined	two in the zone of ±10 cm from the centre of a nominal length	mm units are not taken into account (cutting off)	not determined	diameter is not determined	mathematical average from measured values	mm units are not taken into account (cutting off)	as the cylinder volume
3	CSN 48 0050 Standard - Rough timber: Basic and common regulations, 1990. (Manual measurement)	2D	not defined	two in the zone of ±10 cm from the centre of a nominal length	mathematical rounding	not determined	diameter is not determined	mathematical average from measured values	mathematical rounding	as the cylinder volume
4	CSN 48 0050 Standard - Rough timber: Basic and common regulations, 1990. (Automatic measurement)	2D	not defined	all places by 10 cm in the course of a nominal length	without conversion	not determined	diameter is not determined	mathematical average from measured values	mathematical rounding	as the cylinder volume
5	ON L 1021 Vermessung von Rundholz 2006 Log diameter in cm	2D	not defined	two in the zone of ±10 cm from the centre of a geometrical length	mm units are not taken into account (cutting off)	mathematical average from both measurements	mm units are not taken into account (cutting off)	smaller from diameter values in both places of measurement	already given in cm	as the cylinder volume
6	ON L 1021 Vermessung von Rundholz 2006 Log diameter in mm	2D	not defined	two in the zone of ±10 cm from the centre of a geometrical length	without conversion	mathematical average from both measurements	without conversion	smaller from diameter values in both places of measurement	without conversion	as the cylinder volume
7	Rahmenvereinbarung für die Werksvermessung von Stammholz, 2005. Roundwood up to a diameter of 20 cm.	2D	not defined	two in the zone of ±10 cm from the centre of a nominal length	without conversion	mathematical average from both measurements	without conversion	mathematical average from measured values	mm units are not taken into account (cutting off)	as the cylinder volume
8	Rahmenvereinbarung für die Werksvermessung von Stammholz 2005. Roundwood diameter of 20 cm and more.	2D	not defined	two in the zone of ±10 cm from the centre of a nominal length	mm units are not taken into account (cutting off)	mathematical average from both measurements	without conversion	mathematical average from measured values	mm units are not taken into account (cutting off)	as the cylinder volume
Comparative method	Comparative method 'the most accurate volume'. Volume calculation by 10 cm long sections, diameter in mm	2D	not defined	two at both ends of a section	mathematical rounding	mathematical average from both measurements	without conversion	mathematical average from measured values	without conversion	by 10 cm sections

By means of the same colour the same way of step realization at particular rules are indicated

Table 1. The survey of rules and determined methods of the implementation of particular steps.

scanning is realizable at each equipment fulfilling requirements of given regulations. Evaluation of the “geometrical” volume results from a section method: the volume of a log is the sum of volumes of particular sections. Lengths of sections are 10 cm, which corresponds to the distance of particular measurements of the log diameter determined by present rules. The section diameter is equal to the average value from two measurements perpendicular at each other at the beginning and at the end of the section (four values), the section volume is determined as the volume of a cylinder. Thus, the determination of “geometrical volume” is realizable at any existing equipment after the adjustment of its program (software) equipment. Details are given in a table 1, where this method is termed as “comparative”.

The comparative measurements were carried out on about 180 000 spruce logs. Dimensional and quality properties of logs correspond to logs for sawmill processing (quality class III, qualities A, B and C, classification according to Recommended rules for the measurement and grading of timber in the Czech Republic 2008, Tab. No. 13, p. 70). Supplies (deliveries) were created in 72% by logs in basic lengths 3 to 6 m with the predominance of lengths 4 and 5 m, 28% supplies were logs in combined lengths 7 to 14 m, however mainly 8 to 12 m (relatively uniform proportion). The average mid diameter of logs ranged about 27 cm. Parameters of each log (values of diameters taken horizontally and vertically at a length interval of 10 cm + measurement location + value of length) obtained by long-term operational measurements at 2 sawmills were stored and subsequently processed according to compared rules. In this way, the consistency of input data was provided. Values of particular comparative coefficients are obtained as medians of values of volumes of particular logs determined according to compared procedures but not as the comparison of total volumes of supplies (deliveries) defined according to compared rules. Values of medians differ from values of averages quite insignificantly, namely at the 4th to the 6th decimal place.

The total comparison of log volume values determined according to particular rules with the comparative method of “geometrical volume” (not distinguishing properties of logs) is given in table 2.

The relationship between the log volume determined according to given rules and a “geometrical” volume determined according to a comparative method (i.e. coefficient) is, in the majority of procedures, substantially dependent on the log diameter and less on the log length (although not negligible). Thus, values given in the table 2 apply only to the considerable number of deliveries of saw logs (thousands logs). Dependencies on other parameters (e.g. taper, flattening) were not examined. Reasons consisted in the rather controversial practical efficiency of these dependences even in cases their effects would be proved. However, particular deliveries of logs (ordinarily 80 - 200 logs) differ in their properties and the mean value of their dimensions is often different from a long-term average. Therefore, for the practical use of given coefficients, it is necessary to specify their average values according to properties of actual deliveries. With respect to the “step character” of deviations at the determination of volume of the same log according to different procedures (mainly due to the conversion of mm to cm) standard statistical processing does not provide too objective image on actual properties of particular procedures. The graphic representation of properties of particular procedures is well-arranged.

	<i>Rule</i>	<i>Coefficient</i>	<i>Lower 95%</i>	<i>Upper 95%</i>
1	EN 1309-2 Standard Roundwood and sawn timber – Measurement of dimensions - Part 2: Roundwood. 2006	0.981072	0.980692	0.981453
2	Recommended rules for the measurement and grading of timber in the Czech Republic 2008.	0.941042	0.940679	0.941406
3	ČSN 48 0050 Standard Rough timber. Basic and common regulations. 1990 Manual measurement	1.000764	1.000394	1.001134
4	ČSN 48 0050 Standard Rough timber. Basic and common regulations. 1990 Automatic measurement	0.995303	0.995149	0.995457
5	ÖN L 1021 Vermessung von Rundholz 2006 (log diameter in cm)	0.936393	0.936037	0.936749
6	ÖN L 1021 Vermessung von Rundholz 2006 (log diameter in mm)	0.984777	0.984447	0.985107
7	Rahmenvereinbarung für die Werksvermessung von Stammholz. 2005 (generally)	0.941534	0.941172	0.941896
8	Rahmenvereinbarung für die Werksvermessung von Stammholz. 2005 (only a method up to a diameter of 20 cm)	0.958114	0.957753	0.958474

Table 2. The total comparison of log volume values determined according to particular rules with the comparative method of “geometrical volume” (not distinguishing log properties). The average mid diameter of logs of the basic population ranged between 29 and 30 cm.

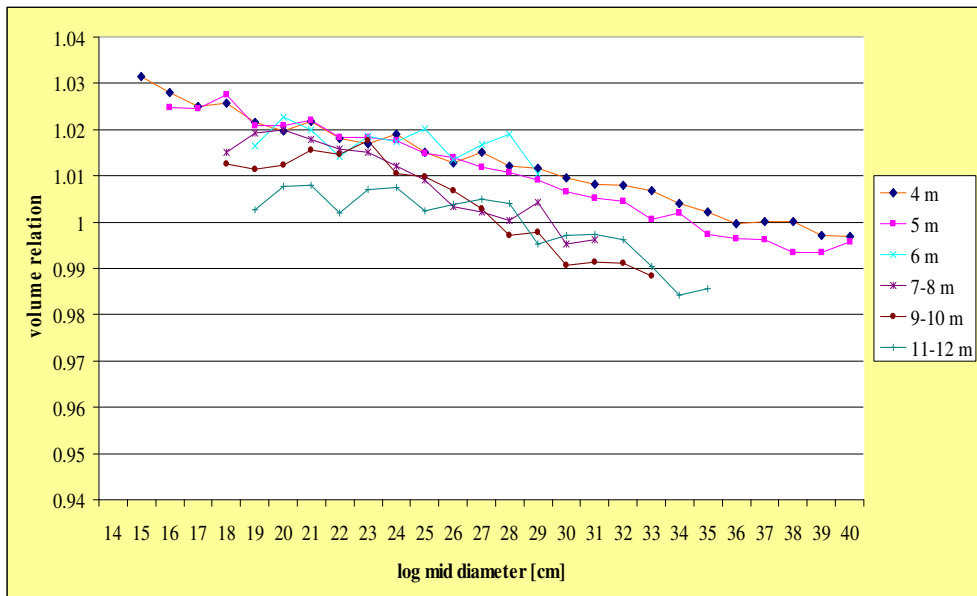

Fig. 9. The relationship between the volume of logs determined according to the ČSN 48 0050 Standard – Rough timber – manual measurement and a comparative method. The dependence of the relationship on the log diameter (x axis) and the log length (particular runs).

The ČSN 48 0050 Standard – Manual measurement is not nearly used in practice. It is chosen as an example because its procedure is consistent with the original Huber method and the dependence of a coefficient on the log diameter and length is (as in Huber method) very marked. (Note: Values of coefficients at sets of logs the number of which did not reach 250 were not plotted – minimum for 0.5% accuracy for 95% results at 0.04 variability determined according to a control sample).

Results of measurements demonstrate a well-known fact that the Huber method generally overvalues small-diameter top logs and undervalues large-diameter but logs (Kolektiv 1959).

The different stem form and subsequently also different evaluation of the log volume becomes also evident in connection with the log length. Regardless of the log diameter the overvaluation of short logs is higher than the overvaluation of longer logs. Particularly visible differences occur between logs in basic and combined lengths. A next diagram, Fig. 10 is well-arranged. It contains only the course of the dependence of logs of length 3 – 6 m (altogether, red course) and 7 – 14 m (also altogether, blue course). In addition to this, the whole group of logs is evaluated regardless of the log length (green course).

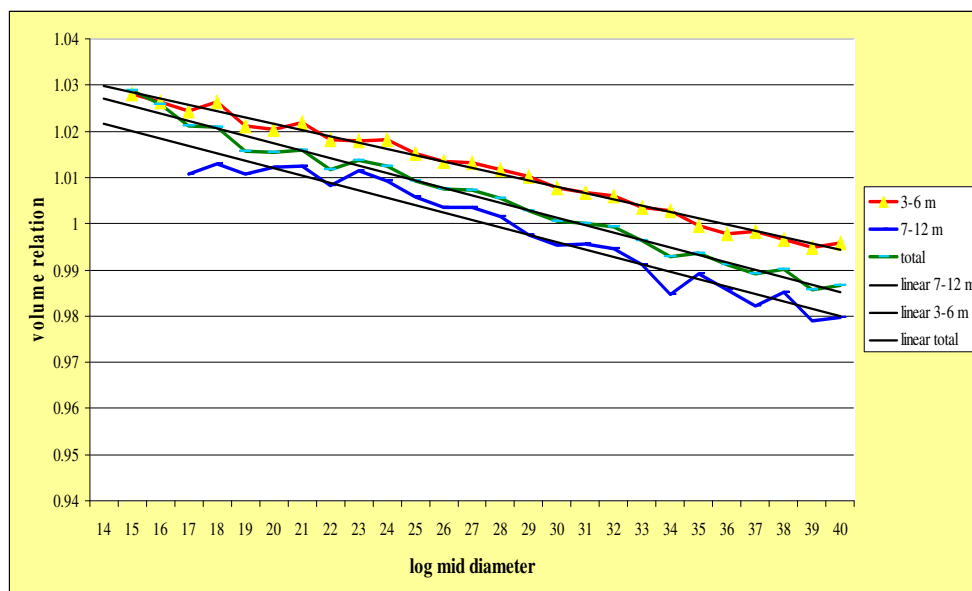

Fig. 10. The relationship between the volume of logs determined according to the ČSN 48 0050 Standard – Rough timber – manual measurement and a comparative method. The dependence of the relationship on the log mid diameter (x axis) and the length of logs (logs 3-6 m and logs 7-12 m). The total dependence (not distinguishing lengths) is expressed as a green line.

On the basis of measurements it is possible to state that on average:

- with the decline of log mid diameter by about 8 cm the value of its volume (determined according to Huber method) increases roughly by 1% as compared with geometrical volume. The dependence very approaches linear dependence.

- together with the geometrical volume, logs of mid diameters about 30 cm are evaluated. Logs in basic lengths are overvaluated already from 35 – 36 cm of a mid diameter while logs in combined lengths from about 27 – 28 cm.

F. X. Huber and also other sources (Šmelko, 2003) explain this fact by the different form of a stem in its butt (large diameter) or top (small diameter) part.

The average value of mid diameters of coniferous logs delivered to sawmills in the Czech Republic ranges between 26 and 28 cm and it is possible to expect its gradual decline. It appears from this that the method mentioned above is inconvenient for consumers of the raw material (particularly logs) and, on the other hand, profitable for suppliers.

Automatic measurement carried out according to the ČSN 48 0050 Standard tries to express the exact actual (geometrical) volume of timber preserving the Huber method. The only possibility is to specify a mid diameter. It is calculated as the average value of all diameter measurements carried out within the nominal log length.

Results are given in Fig. 11. The course is rather balanced within the whole zone of monitored diameters. Thanks to the calculation of the log mid diameter from values taken within the whole (nominal) log length the overvaluation of small-diameter logs (typical of Huber method) is very limited. It becomes evident only at logs with a mid diameter up to about 18 cm, the volume of which is overvalued (on average) by 0.5%. The volume of logs within a mid diameter about 18 – 20 cm is evaluated according to the real volume. The volume of logs of larger diameters is evaluated similarly if they are in basic lengths (3 – 6 m). A lower than real volume (on average 0.5 to 0.7%) is evaluated only at logs of combined lengths and this deviation is rather balanced at all logs of mid diameters over 20 – 22 cm.

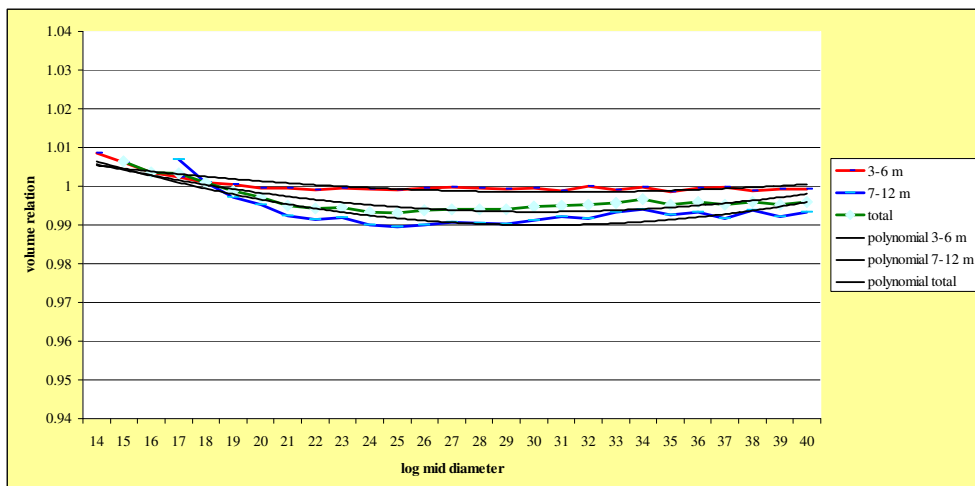

Fig. 11. The relationship between the volume of logs determined according to the ČSN 48 0050 Standard – Rough timber – automatic measurement and a comparable method. The dependence of the relationship on a mid diameter (x axis) and the log length (logs 3-6 m and logs 7-12 m). The total dependence (not distinguishing lengths) is expressed as a green line. The course of measured values is approximated to the polynomial of the 2nd degree.

The EN 1309-2 Standard – Roundwood and sawn timber – “Methods of measuring dimensions” is used only rarely at timber reception (ČSN 49 0018, EN 1309-2, 2006). In the CR, its use has not been noted at all.

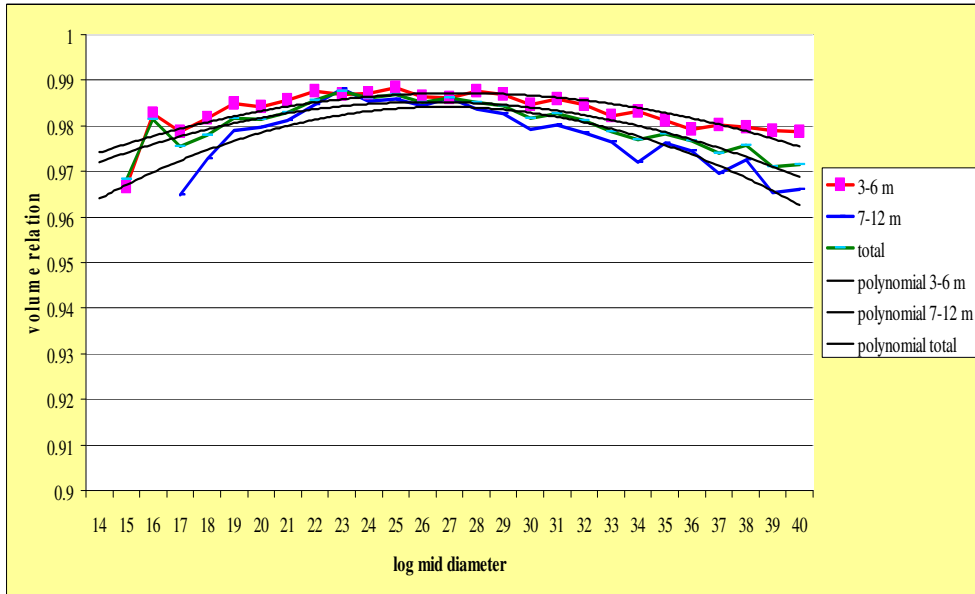

Fig. 12. The relationship between the volumes of logs determined according to the EN 1309-2 Standard – Roundwood and sawn timber – Methods of measuring dimensions and a comparative method). The dependence of the relationship on a mid diameter (x axis) and the log length (logs 3-6 m and 7-12 m). The total dependence (not distinguishing lengths) is expressed as a green line.

Properties of the EN 1309 – 2 Standard are formed by two antagonistic effects – Huber method, which is a basis of the standard and the conversion of mm values of the log mid diameter to cm (“cutting off” mm).

The Huber method tends to undervalue large-diameter logs and to overvalue small-diameter logs. The effect of Huber method prevails in total properties of the EN 1309 – 2 Standard in the field of large-diameter logs where it manifests itself by the fall of characteristics.

At the conversion of millimetre values of the mid diameter to centimetres the standard combines i.e. mm are not taken into account (values of particular measurements) and mathematical rounding (values of the diameter in places of measurements and at the expression of a resulting mid diameter).

The primary “cutting off” of measured diameter values causes the total marked decline of resulting values of log volumes. It becomes evident particularly at small-diameter logs where the decline of a value of a subsequently calculated volume as compared with mathematical rounding can achieve even 5 – 7%.

The size of the fall of total characteristics of the EN 1309 – 2 Standard in the area of small-diameter and large-diameter logs is also dependent on the length of logs. Volumes of logs of basic lengths both the smallest (14 – 15 cm) and large (39 – 40 cm) diameters are evaluated by the method by about 2.5 to 3% lower than it corresponds to the geometrical volume. The volume of logs in combined lengths is (in the same comparison) lower by about 3.5%. Logs of medium diameters (between about 23 and 29 cm) are undervalued equally – by about 1.2 to 1.7%. Differences between evaluations of volumes in basic and combined lengths are small in the middle zone – the volume of logs in combined lengths is usually evaluated by 0.2 to 0.3% lower, than the volume of logs in basic lengths.

Recommended rules for the measurement and grading of timber in the Czech Republic 2008 determine for manual and electronic measurements virtually the same procedure. At manual measurements, the log mid diameter is an average from two values measured perpendicular each other in the centre of its nominal length. Only in case of anomaly in the log centre, two measurements are carried out near the anomaly in the same distance from the log centre, the mid diameter being the average value from four measurements. Electronic measurements determine the log mid diameter from these four values always.

Note: A German general agreement *Rahmenvereinbarung für die Werksvermessung von Stammholz* (2005) defines the mid diameter determination in the same way, however, only for log diameters ≥ 20 cm.

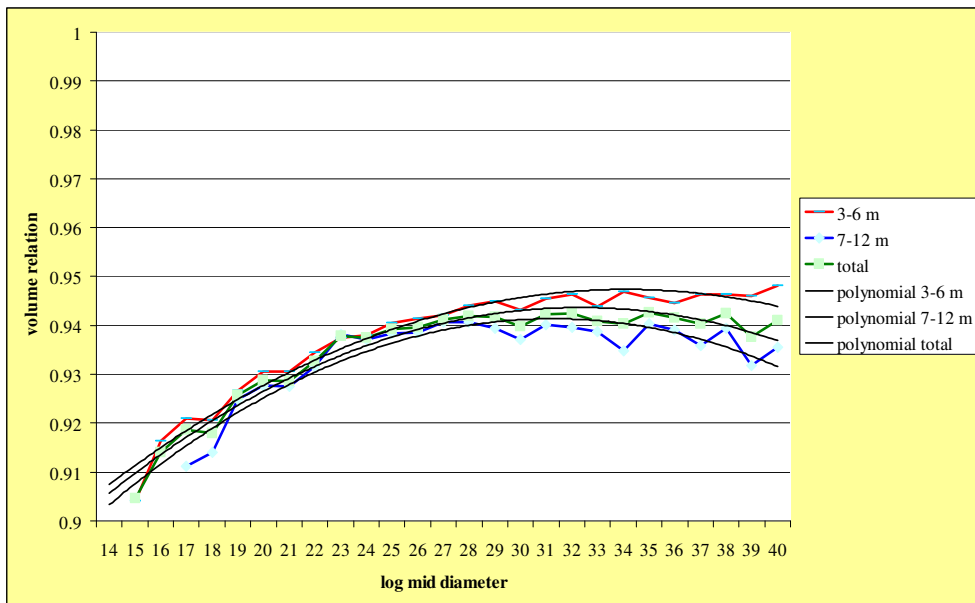

Fig. 13. The relationship between volumes of logs determined according to Recommended rules for the measurement and grading of timber in the Czech Republic 2008 and a comparative method. Dependence of the relationship on the log mid diameter (x axis) and the length of logs (logs 3-6 m and 7-12 m). The total dependence (not distinguishing lengths) is expressed as a green line.

Cutting off (millimetres are not taken into account) at the conversion of values of measurements given in mm to whole cm and subsequently also the conversion of an average value from these data in the same way becomes evident by the marked decline of values of the volume of all logs. This decline is particularly evident at small-diameter logs (up to 26 - 27 cm). Within the range of mid diameters (15 to 26 cm) the fall ranges from about 8.5% (to 91.5%) to about 5.5% (to 94.5%) as compared to the geometrical volume. The effect of the log length is not significant at small-diameter logs. At further increasing the log mid diameter the value of the difference does not increase. However, effects of the log length start to manifest. Logs in basic lengths keep their deviation from a geometric volume on a stable value about 5.3% (94.7% value of the log geometric volume). Logs in combined lengths slightly increase the value of their deviation (at 40 cm diameter, they reach the value of a deviation about 6.2%, i.e. 93.8% geometrical volume).

Comparing the courses with the previous "ČSN EN 1309-2 (49 0018) Standard - Roundwood and sawn timber" we can state that the double "cutting off" mm units at the determination of the log mid diameter becomes evident by more than double increasing the volume deviations (in percent) at logs of all diameters. The trend of decline is identical.

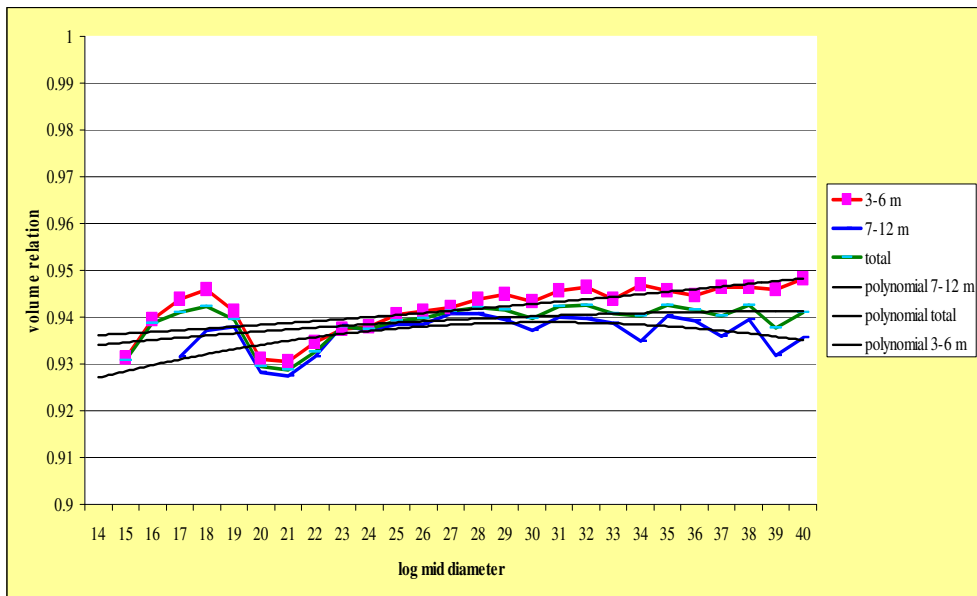

Fig. 14. The relationship between the volumes of logs determined according to Rahmenvereinbarung für die Werksvermessung von Stammholz 2005 and a comparative method. The dependence of the relationship on a mid diameter (x axis) and the length of logs (logs 3-6 m and 7-12 m). The total dependence (not distinguishing lengths) is expressed as a green line.

Rahmenvereinbarung für die Werksvermessung von Stammholz, a general agreement for the measurement of round timber at sawmills used in Germany tries at least partly to balance the decline described below. Therefore, at logs up to 20 cm, the conversion of measured

values is not carried out. Only the calculated value of the mid diameter is converted. Thus, "only" one cutting off mm is carried out.

The described adjustment gradually balances the general characteristics of the procedure and the evaluated volume is generally approached to reality (it evaluates on average 94% geometrical volume, average deviation is 6%). However, this value is only of orientation character. In reality, it substantially depends on the diameter structure of logs in the actual delivery.

The Austrian standard *Ö-Norm L 1021 Vermessung von Rundholz* (2006) approaches Recommended rules for the measurement and grading of timber in the Czech Republic 2008 as for the determination of the log mid diameter and calculation of its volume. The log mid diameter is not determined as an average diameter but as the smaller one from diameters in both places of measurement and the position of a mid diameter is derived from a geometric and not nominal length. Thus, the place of measurement is shifted by half the length of an actual allowance towards the top end. The value of mid diameter and subsequently the log volume are thus slightly lower. The higher value of allowances (the volume of these allowances is not included into the log volume) results paradoxically in the lower evaluated diameter and volume of logs.

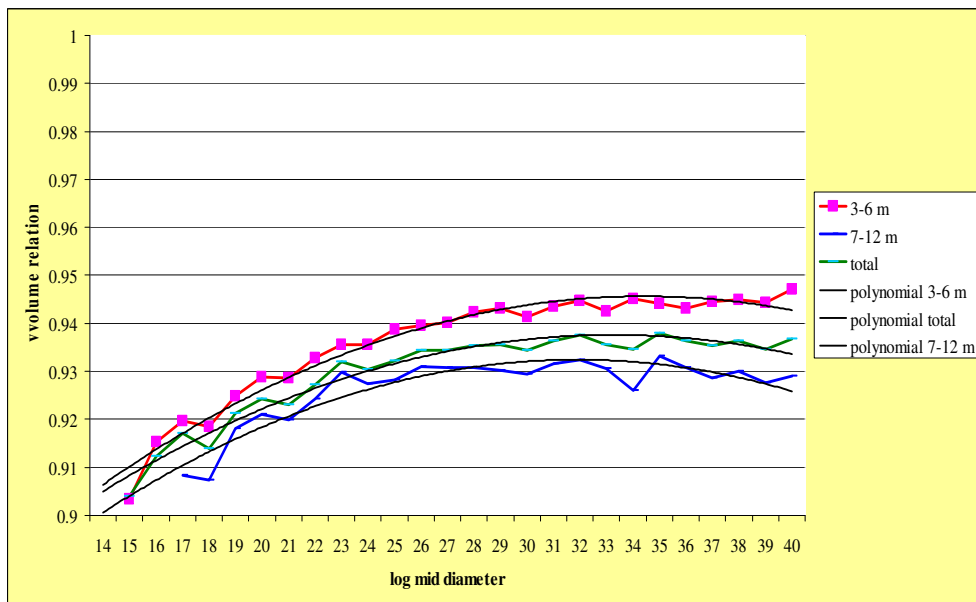

Fig. 15. The relationship between the volumes of logs determined according to the Austrian *Ö-Norm L 1021* (2006) Standard and a comparative method. Values of a mid diameter are given in cm. The dependence of the relationship on a mid diameter (x axis) and the length of logs (logs 3-6 m and 7-12 m). The total dependence (not distinguishing lengths) is expressed as a green line.

The determination of a mid diameter as a smaller but not average value from both places of measurements becomes evident (thanks to a very small distance of both measurements /10

cm/) by the total decline of evaluated volumes only very little – by about 0.2%. This value determined by a separate analysis is significant only at the total delivered volume of timber for a certain period (e.g. a month) or at least of whole supplies (deliveries). At particular logs, it virtually coincides with the accuracy of measurement. The practical result of the effect of allowances is different at logs in basic lengths and combined lengths. Logs in basic lengths have allowances rather exact in length (up to 2.5%) and their effect on decreasing the calculated value of the log volume ranges at a level of 0.1 – 0.2%, however, often only in hundredths percent. The effect can be statistically specified, however, it is not possible to prove it virtually by measurements at particular logs (contrary to calculations). At logs in combined lengths, larger (longer) allowances are usually left for the purpose of subsequent cross-cutting. It results in higher values of the decline of evaluated volume by 0.2 to 1.0%.

Note: For the purpose of cross-cutting longer allowances than generally accepted 2 or 1.5% are locally negotiated at logs in combined lengths. In order this step to have no negative impacts on roundwood suppliers additional charges are also usually negotiated for these allowances.

ÖN L 1021 *Vermessung von Rundholz* makes possible to evaluate mid diameters and subsequently also the volume of logs from values given in mm without conversion to whole cm. Otherwise, the procedure is consistent with the previous procedure.

This alternative markedly approaches evaluated diameters and thus also volumes of all logs to their real geometrical values and, at the same time, avoids the decline of evaluated volumes of logs of small diameters. However, undervaluation of large-diameter logs characteristic of Huber method remains.

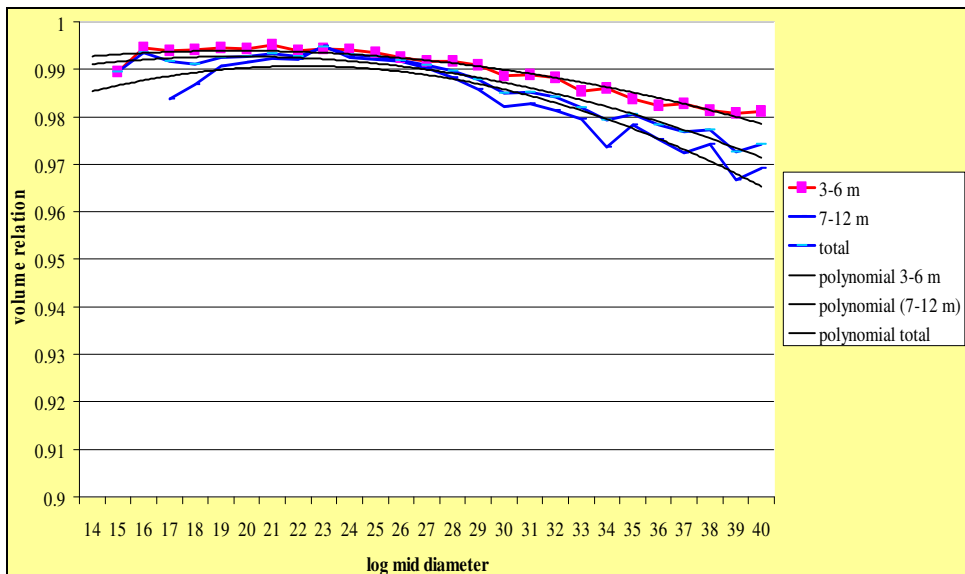

Fig. 16. The relationship between the volume of logs determined according to the Austrian Ö-Norm L 1021 (2006) Standard and a comparative method. Values of a mid diameter are given in mm. The dependence of the relationship on a mid diameter (x axis) and the length of logs (logs 3-6 m and 7-12 m). The total dependence (not distinguishing lengths) is expressed as a green line.

By its results, the procedure is comparable with the EN 1309 – 2 Standard. The higher value of the evaluated volume of logs according to the Ö-Norm L 1021 Standard by about 1% in the area of log diameters over 24 cm is caused mainly by removing the conversion of mm values of the mid diameter to whole cm not taking mm units into account. A fact that a difference obvious in the diagram is lower than a difference mentioned here causes the reduction of the log volume value at ÖN L 1021 placing the mid diameter measurement into the centre of a geometrical length and determination of the mid diameter as a lower but not average value from measurements in both places of the measuring area.

The advantage of the ÖN L 1021 Standard at the evaluation of the mm values of measurements consists in the even course of characteristics in the zone of log diameters below about 24 cm. Methods using “cutting off “ mm units (although “only” once, such as EN 1309-2) show an appreciable decline in this area. However, no sawmill was found, which would virtually use the given version of Ö-Norm L 1021.

6. Possibilities of minimizing the differences

At present, the accuracy of sensing and evaluating the log length ranges about ± 2 cm, diameter ± 1 mm, directions of the diameter measurement are usually 2 perpendicular at each other (at 2D sensing) up to 180 (i.e. at 1° angular rotation at 3D sensing), the diameter measurement density is between 1 and 10 cm log length.

For the purpose of wood processing the accuracy and details of taken and evaluated parameters of logs are quite sufficient. At trading with timber, an error occurring at the determination of dimensions or volume of logs is not a difficulty (problem), but differences in values of these quantities, which originate at using different methods of measurement (sensing and evaluating results obtained).

An ideal procedure to increase the accuracy of evaluating the log volume and to remove differences originating among particular procedures of measurements is to create and accept one technically unambiguous legislative rule (law, standard) obligatory for the electronic measurement of timber for the purpose of trading, and thus also electronic reception. However, expectations to create and mainly to accept such rules and regulations are not real at present both at a national and international level. To minimize effects of different rules it is necessary to start from following facts:

- At present, the accuracy of log dimension measurements is not limited by accuracy or the density of sensing (accuracy ordinarily ± 1 mm, sensing frequency commonly in kHz) or possibilities of evaluating the results of measurement.
- Accuracy of the evaluation of results is given by procedures derived from procedures for the manual measurement (determination of a mid diameter only from measurements carried out in the area of the log centre, determination of the log volume as the volume of one cylinder of a diameter equal to the log mid diameter and a length equal to the log nominal length).
- Regulations do not describe quite exactly all steps of processing the scanned data necessary at the electronic measurement. Thus, there is an area for the individual interpretation of the rules and affecting the results of measurements without the legislative disturbance of rules. It refers mainly to the filtration of scanned data (it is not

defined at all) and directions where the mid diameter is evaluated. In some rules, these are determined only as “perpendicular at each other” and concrete directions are not specified.

- The result of different interpretation consists in using 2D and 3D measurement the application of which and differences in results are not affected by the rules.
- The inspection of measuring devices (setting and accuracy of measurements) is also derived from the inspection of traditional mechanical means of measurement. It is carried out by a tape and circular measurement standards (etalons) in the static condition of a line. By means of such checking it is possible to reveal possible inaccuracies of sensing but not the effect of filtration and subsequent evaluation of the mid diameter and volume.

If we suppose the use of more methods in the future, the value of the log volume (reached at the electronic measurement of timber) will correspond rather to commercial needs than to the geometrical volume. Thus, it is necessary to understand it as a “commercial volume”. Following steps are derived to increase the stability of measurements (repeatability with the same or near results) by any method and to reduce deviations.

It is inevitable to determine unambiguously the method of assessment and implementation of particular steps of the algorithm of data processing. Without these conditions it is not possible to determine more exactly properties of the given procedure (regulations, standards). It represents:

- To determine exactly the method of filtration of scanned data. For the central part of a log a combined procedure is recommended removing extreme values in the first part and in the following part slightly balancing the course not fundamentally affecting or eliminating values of local roughness (e.g. stem curvature, burls, root swelling). “Sliding” conditions tend to increase total values (effects of extreme values). For end parts (butt end, top end), it is suitable to start from the regression analysis of the course of diameters in the related log part (Hunková, 2011).
- To define particular directions where the log diameter is to be evaluated. The determination of only two measurements perpendicular at each other not determining their directions (e.g. horizontally and vertically) or without the assessment of the direction equability of the evaluated measurement at a measured log makes possible to find out minima and thus to decline the resulting value. On the contrary, the determination of searching for a minimum value right in the rule disadvantages or even forbids the use of 2D sensors common at present (Janák, 2007).

It is suitable to determine the quality of roudwood where results of measurements are still valid. The worst quality of saw logs is supposed. At the worse quality of logs (sweep, stem curvature, knots, buttress) it is possible to suppose higher misrepresenting effects of data filtration and thus the decline of measurement accuracy.

Properties of used procedures (mainly dependences of the value of the calculated log volume) have to be determined with respect to a reference method. The comparison of two methods is suitable only for particular cases and cannot be used for the determination of actual properties of procedures. The volume of logs determined by a reference method has to approach geometrical volume. Comparison with a geometrical volume determined e.g. by a volumetric method (Hauffe, P. & Müller, L, 2002) is ideal however laborious, time

consuming and not practicable everywhere. A procedure of measuring the logs by sections appears to be sufficiently accurate and generally practicable. The length of sections derived from the minimum requirements of present regulations is 10 cm. In addition, the method accuracy is supported by the lower sensitiveness of the section method to the type of filtration. Misrepresenting effects of filtration become evident in the volume deviation of one section but not of the whole log (in a limiting case). Properties of particular procedures given in this paper are expressed in the same way.

To check and calibrate the equipment, procedures are proposed, which affect both accuracy of sensing geometric parameters of timber (logs) and the method of their evaluation. It is achieved by static sensing the etalons/measurement standards/ (the present method of the inspection of accuracy of setting the equipment and sensing the log dimensions) and subsequent operational (dynamic) measurement (checking the filtration and processing results of measurements). For calibration in this way it is necessary to determine (in rules, regulations) allowable tolerances of particular measurements and resulting evaluated values. It has not been determined for dynamic measurements yet.

The inspection of equipment is also related to the determination of authorities qualified to check and calibrate electronic measuring devices (existing in the majority of countries) and determination of sanctions at the infraction of agreed procedures of measurements and determination of geometrical parameters of logs (so far not existing in the Czech Republic). However, it refers to themes occurring out of the field of measuring systems.

7. Conclusion

For the electronic reception of roundwood, 2D and 3D systems of the measurement of roundwood diameter are used virtually exclusively. 1D systems do not provide exact data on geometrical properties of logs being also not permitted by any of standard rules (not mentioned in the survey).

Regulations, which are mostly used for the electronic reception of roundwood are as follows: Recommended rules for the measurement and grading of timber in the Czech Republic 2008 (both manual and electronic measurements), Austrian ÖNorm L 1021 (a version which gives roundwood diameter in cm) and German Rahmenvereinbarung für die Werksvermessung von Stammholz. Measurements according to these standards (particularly ÖNorm L 1021) are also used by many company regulations of the supra-national processors of roundwood.

All these regulations determine the roundwood volume as the volume of one cylinder of a diameter equal to the mid log diameter and length equal to the nominal length of a log, thus according to traditional methods of the manual measurement. According to manual measurements, diameter is also given in whole cm (exceptions are only logs up to a diameter of 20 cm at Rahmenvereinbarung für die Werksvermessung von Stammholz. Thus, for the determination of the log volume not even accuracy or the density of sensing, which is characteristic of present electronic systems (required by present regulations), are used.

The algorithm of the roundwood volume determination of any rule mentioned above does not result in the determination of the log geometric volume or a volume near the value but a volume, which is lower. The decline is mainly caused by the mid diameter value given in

whole cm. Units of mm, which are included in electronically taken data, are not taken into account at the conversion. This “cutting off” is carried out even 2 times one after another in the course of calculations, namely at basic measured values and at average values.

The rate of decline of values of the log volume achieved according to particular procedures is compared with the volume of logs determined by a section method (sections as cylinders of a length of 10 cm and diameters given in mm). The method is selected because it evaluates (from given data on the log) a volume, which is closest to the log geometrical volume. The rate of decline varies from -5.5% (German Rahmenvereinbarung für die Werksvermessung von Stammholz, logs of medium diameters) to -9% (Austrian Ö-Norm L 1021, mid diameter value given in whole cm). Procedures, which give lower deviations (EN 1309-2 - 1.5 to 3%, ÖNorm L 1021, mm version - 0.7 to 3% or the ČSN 48 0050 Standard 48 0050 - 1 0.3 to 0.8%) are used minimally in practice (in the CR, their use was not found at all). Results achieved correspond to a comparison carried out in Germany (Sauter, U., Staudenmaier, J. & Verhoff, S. 2010).

The values are affected by the way of filtration of taken data. The filtration is a necessary step, which is carried out always. The method of its implementation is not, however, included in any known Central-European regulation. Through various types of filtration applied at the same taken data on logs even about 2% deviations (from values presented in the paper) were achieved.

At the majority of procedures, the fall (deviation) is considerably dependent on the roundwood diameter. It is less dependent (but not insignificantly) on its length. In the paper, the dependences are presented in diagrams. Values of the roundwood/log volume obtained by one procedure cannot be therefore “converted” (with operational accuracy) to values obtained by another procedure using one universal coefficient. It is always necessary to take into account properties of the concrete delivery of roundwood.

From the operational aspect it is not necessary to know the volume of roundwood exactly. Present technically achievable accuracy is quite sufficient for timber processing. From commercial aspects, the actual deviation is not important but its various values at various procedures.

An ideal solution into the future is to unify procedures. However, experience from negotiations does not make possible the author to believe in the early realization of this solution, because the will of parties concerned is missing. Therefore, it is necessary to aim at:

- Exact defining all steps of sensing and processing the data of algorithms, the regulations to provide minimum space for “individual interpretation” and thus affecting results (at present e.g. 2D and 3D sensing but also filtration).
- Definite determination of a method of the mutual comparison of results. In addition to the higher accuracy of comparison there is also the decline of commercial profitability to use various procedures.
- The inspection and calibration of measuring equipment, which will involve and affect checking the implementation of all steps including the value of a resulting volume (at present, it does not include e.g. data filtration). Calibration should be worked out both technically and legislatively.

8. References

- ČSN 49 0018, EN 1309-2 (2006). *Kulatina a řezivo – Metody měření rozměrů. Část 2: Kulatina – požadavky na měření a pravidla pro výpočet objemu*. Český normalizační institut, Praha, Czech Republic
- ČSN 48 0050 (1992). *Surové dříví. Základní a společná ustanovení*. Federální úřad pro normalizaci a měření. Praha, Czech Republic
- Deutscher Forstwirtschaftsrat e.V. & Verband der Deutschen Säge- und Holzindustrie e.V. (2005). *Rahmenvereinbarung für die Werksvermessung von Stammholz*, Version 2005-01-14.
- Hauffe, P. & Müller, L. (2002). Rundholzvermessung in Europa vereinheitlichen. *Holz-Zentralblatt* N. 77, 28. 6. 2002, p. 948
- Hunková, V. (2011). *Faktory ovlivňující přejímku kulatiny při elektronickém měření jejích rozměrů*. Mendel University Brno, Czech Republic
- Janák, K. (2007). Differences in round wood measurements using electronic 2D and 3D systems and standard manual method. *Drvena Industrija* Vol 58 (3) 2007 pp. (127-133), ISSN 0012-6772
- Kolektiv (1959). *Naučný slovník lesnický*, Státní zemědělské nakladatelství Praha, Czech Republic
- Kolektiv (2008). *Doporučená pravidla pro měření a třídění dříví v České republice 2008*. ISBN 978-80-87154-01-4 Lesnická práce, Praha, Czech Republic
- Ö-Norm L 1021 (2006). *Vermessung von Rundholz*. Österreichisches Normungsinstitut, Vienna, Austria
- Sauter, U., Staudenmaier, J. & Verhoff, S. (2010). Mehr Transparenz im Rundholzgeschäft *Holz-Zentralblatt* N. 50, 17. Dezember 2010– pp. 1269-1271
- Šmelko, Š. et al. (2003). *Meranie lesa a dreva*. ISBN 80-89100-14-7 Zvolen, Slovakia

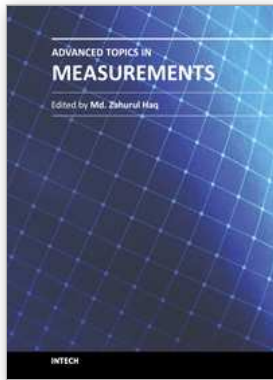

Advanced Topics in Measurements

Edited by Prof. Zahurul Haq

ISBN 978-953-51-0128-4

Hard cover, 400 pages

Publisher InTech

Published online 07, March, 2012

Published in print edition March, 2012

Measurement is a multidisciplinary experimental science. Measurement systems synergistically blend science, engineering and statistical methods to provide fundamental data for research, design and development, control of processes and operations, and facilitate safe and economic performance of systems. In recent years, measuring techniques have expanded rapidly and gained maturity, through extensive research activities and hardware advancements. With individual chapters authored by eminent professionals in their respective topics, Advanced Topics in Measurements attempts to provide a comprehensive presentation and in-depth guidance on some of the key applied and advanced topics in measurements for scientists, engineers and educators.

How to reference

In order to correctly reference this scholarly work, feel free to copy and paste the following:

Karel Janák (2012). Round Wood Measurement System, Advanced Topics in Measurements, Prof. Zahurul Haq (Ed.), ISBN: 978-953-51-0128-4, InTech, Available from: <http://www.intechopen.com/books/advanced-topics-in-measurements/round-wood-measurement>

INTECH

open science | open minds

InTech Europe

University Campus STeP Ri
Slavka Krautzeka 83/A
51000 Rijeka, Croatia
Phone: +385 (51) 770 447
Fax: +385 (51) 686 166
www.intechopen.com

InTech China

Unit 405, Office Block, Hotel Equatorial Shanghai
No.65, Yan An Road (West), Shanghai, 200040, China
中国上海市延安西路65号上海国际贵都大饭店办公楼405单元
Phone: +86-21-62489820
Fax: +86-21-62489821

© 2012 The Author(s). Licensee IntechOpen. This is an open access article distributed under the terms of the [Creative Commons Attribution 3.0 License](#), which permits unrestricted use, distribution, and reproduction in any medium, provided the original work is properly cited.