

# Helium Circulation System (HCS) for the MEG

Tsunehiro Takeda, Masahiro Okamoto,  
Takashi Miyazaki, Naoki Morita and Keishi Katagiri  
*The University of Tokyo / Frontier Technology Institute Inc.*  
Japan

## 1. Introduction

This chapter describes newly developed helium circulation system (HCS) for the magnetoencephalography (MEG) that re-liquefies all the evaporating helium gas using GM (Gifford-Macmahon) cryocoolers operating at 4.2 K. It consumes far less power than conventional systems which cannot be applied for MEGs because of their high noises. Warm helium gas at about 40 K collected high above the surface of the liquid helium in the dewar is used to keep the dewar cold, and cold helium gas just above the liquid helium surface is collected and re-liquefied while still cold. A special transfer tube with multi pipes has been developed to make the system operate efficiently. The system can produce up to 35.5 l/D of liquid helium from the evaporated helium.

A MEG (PR2440 440 CH system, Yokokawa Electric Co. Ltd., Tokyo) with the HCS was used to measure human brain responses for several years without any noise problems. An improved HCS is now operating at Nagoya University, Japan. The noise level is below 10 ft/Hz<sup>1/2</sup> for 2-40 Hz, below 30 ft/Hz<sup>1/2</sup> at 1 Hz, and 200 ft/Hz<sup>1/2</sup> at 60 Hz, which is the power supply frequency. The maintenance cost of the MEG has become less than one-tenth of the previous cost.

## 2. Requirements for the HCS

MEGs are very expensive to run because of their cooling system. They use about 10 liters per day (l/D) of liquid helium (LHe), and commonly waste all of it by letting it escape into the atmosphere, necessitating the troublesome task of refilling the dewar with LHe once or twice per week, which must be done by a trained technician.

The most common and efficient LHe producing system uses a Collins-type liquefier (Shigi et. al., 1982). As this system uses very high pressure, it becomes very large and is unsuitable to use for MEGs. Although a cooling system that can achieve LHe temperatures by direct cooling with a small cryocooler has been developed, it is too noisy for MEGs (Kang et. al., 1998). Other small systems that collect the evaporating helium at room temperature and return it to the dewar after liquefaction have also been developed (e.g., TRG-350D, TaiyoNissan Co. Ltd., Tokyo; HRT-K212, Sumitomo Heavy Industries Ltd., Tokyo). They cool the collected evaporated helium to about 40 K using sub-cryocoolers, then to below 4.2 K using the main cryocoolers, and then return the liquefied helium to the cryostat. However, the liquefaction requires much electricity because the evaporated helium approaches room temperature before being cooled and because the specific heat capacity of helium is

relatively high. Moreover, they are also still noisy for MEGs. Therefore there had been no cooling system specifically suited to MEGs.

As MEG sensor coils must be placed near to the patient's head to detect their very weak magnetic fields, a liquid nitrogen heat shield, commonly used for Magnetic Resonance Imaging (MRI), cannot be used with MEGs. Hence, LHe is used to cool the dewar as well as the Superconducting Quantum Interference Devices (SQUIDs). In fact, because SQUIDs produce little heat, the LHe is mostly used for the former purpose, which is very inefficient. It would be more efficient to use relatively higher temperature helium gas (HeG) rather than LHe, to cool the dewar (Takeda et. al., 2001, 2005).

In light of all the above serious drawbacks of the existing cooling systems, the requirements of an efficient small cooling system for MEGs to develop are (1) a noise level should be low enough, (2) it need not be refilled the liquid helium frequently, and (3) it should be cheap enough to maintain.

### 3. Basic idea of the HCS (Takeda et. al., 2008)

The main principle of the HCS is to use relatively warm HeG to counter heat flowing into the dewar from the surroundings, while using the LHe to cool the SQUID. The basic design is outlined in Fig. 1. In the dewar, the HeG near the surface of the LHe will be much colder than the HeG near the top of the dewar. The colder HeG goes through pipe B to the condenser at the second cooling stage where it is liquefied, and then the LHe flows under gravity back to the dewar through pipe A. The outlet of pipe A is near the surface of the

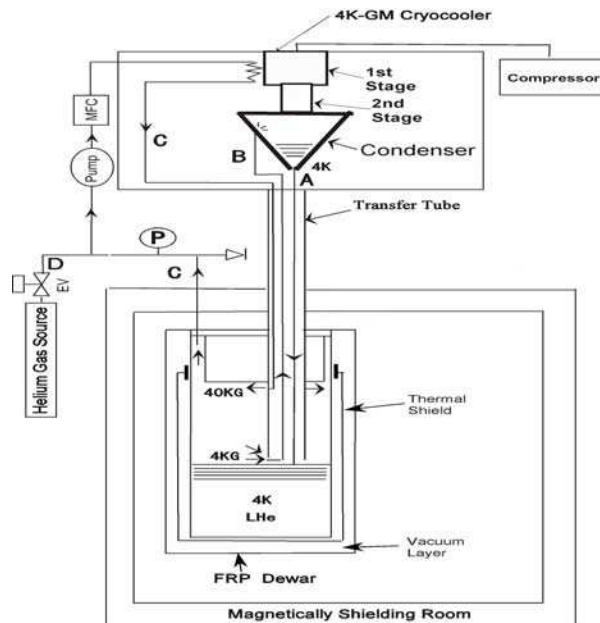

Fig. 1. Helium circulation system. A: pipe to lead LHe from condenser to dewar, B: pipe to lead lower temperature HeG from dewar to condenser, C: pipe to circulate higher temperature HeG, D: pipe to add pure HeG. EV: electric valve, MFC: mass flow controller.

LHe and about 10 mm below the inlet of pipe B. The warmer HeG, which is at about 40 K at the outlet of pipe C, cools the dewar as it passes through its neck. The warmed HeG is led to the first stage of the cryocoolers at a flow rate governed by a small pump and a mass flow controller (MFC). The outlet of pipe C is about 200 mm above the outlet of pipe A. Having the outlet of pipe C high above the LHe ensures that the temperature gradient between the outlet of pipe C and the LHe is relatively small, thus lowering the heat flow into the LHe. If the LHe level drops for some reason, the helium gas from a reservoir can be supplied through pipe D and liquefied, which recovers LHe level.

Since the amount of helium that evaporates, and thus the amount that has to be liquefied, depends on the ambient temperature, a large capacity cryocooler is essential to cope with a wide range of ambient temperature. On the other hand, if the cryocooler liquefies too much helium, the pressure inside the system may drop, causing air to flow into the system. Therefore, our system uses two 1.5W@4.2K GM (Gifford-McMahon) cryocoolers to ensure sufficient cooling capacity and, under feedback control from the pressure in the dewar, a 3 W heater attached to the condenser to prevent overcooling.

The transfer tube is shown in Fig. 2. The transfer tube is attached to the dewar such that a vacuum separating pipes A, B and C, which are concentric, is a continuum of the vacuum in the wall of the cold chamber shown on the far left. The vacuum also separates pipe C from the ambient air. The connection flange (E) allows thermometers to be replaced.

The shield shown in section figure D is made of a thick copper pipe and protects against incoming thermal radiation. It is connected to the first stage of the cryocoolers by flexible copper wires. The copper wires and the flange with bellows enable the transfer tube to be set up through a hole in the wall of the magnetically shielded room (MSR). The heat flowing from the surroundings to the LHe through the transfer tube was estimated to be lower than 0.2 W/m.

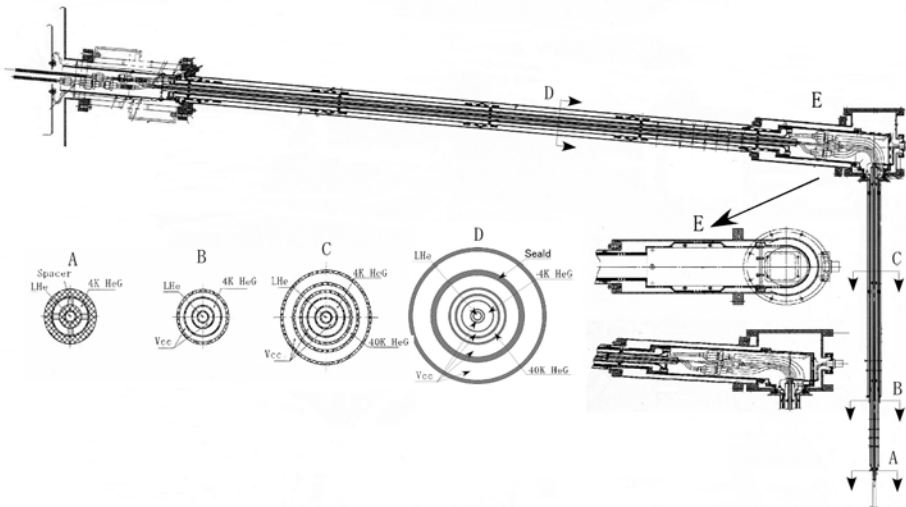

Fig. 2. Transfer tube consisting of seven concentric pipes. A, B, C, D are cross sections of TT at the indicated places. E is the structure of the elbow connecting the horizontal and vertical parts of TT. The lengths of the horizontal and vertical parts are about 2 and 1 m, respectively, and their diameters are 76 and 38 mm, respectively.

#### 4. Performance of the HCS with an experimental Dewar (Takeda et. al., 2008)

Fig. 3 shows how the temperature in different parts of the system changed during the first two and a half days after the system was started up. It also shows the change in the level of the LHe in the dewar. At start up, HeG at room temperature was filled to the system and it was automatically admitted into the system through pipe D according to the temperature drop and helium liquefaction under pressure feedback control. About 5 hours after start up, TA, the temperature of the first stage of the cryocoolers, had decreased from room temperature to 4.2 K, and about 13 hours after start up, T1, the temperature of pipe C just after the first stage of the cryocoolers, had decreased to 40 K. The temperatures at elbows of the TT (Ce, Be, Ae) stabilized at about 22 hours after start up. Though the temperatures at Be and Ae fluctuated in an interesting manner, it is beyond the scope of this report, but its analysis using computer simulation will be discussed elsewhere.

The LHe in the dewar started to increase about 24 hours after start up. As there was a 14-mm gap between the bottom of the LHe level meter and the bottom of the dewar, LHe had started to accumulate about two hours previous. The level reached the height of the inlet of HeG (the inlet of pipe B) about 34 cm above the bottom of the level meter at about 27 hours after start up, and blocked the path of the HeG to the condenser, stopping further increase in the LHe. The level of LHe, however, fluctuated for about 4 hours when the LHe first came into contact with TT due to heat flow from TT. LHe increased at a rate of about 5.5 l/D on average (the diameter of the dewar was 250 mm). After the heater on the condenser was

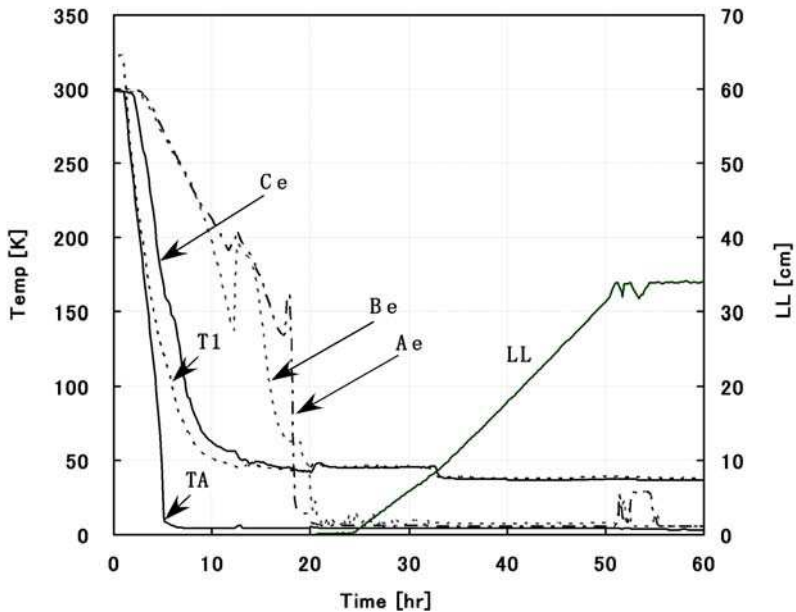

Fig. 3. Typical data showing temperature change, from start up, at different locations of the system, and the LHe level in the dewar. TA: temperature at the second stage of the cryocooler, T1: temperature of the pipe C just after the first stage of the cryocooler, Ce, Be, Ae are temperatures of the pipes C, B, A at the elbow part of the TT. LL: level of LHe.

turned on about 55 hours from start up to keep the pressure of the HeG at about 1 kPa (101 kPa in absolute pressure), the LHe level remained stable.

In the set up used to measure the performance of the system, there was an additional heater at the bottom of the dewar which was used to measure the residual capacity of the cryocoolers to maintain the level of the LHe. The capacity was found to be 1.1 W. When the TT was not attached to the dewar, about 35.5 l/D of helium evaporated from the dewar, estimated by supplying 1.1 W of heat to the LHe. In the real situation, some more heat would be flowing from the inserted TT. Therefore, it was confirmed that at least 35.5 l/D of LHe could be re-liquefied in the experimental system. This amount is adequate for nearly all the existing MEG systems, which require about 10 l/D.

Fig. 4a and 4b shows vibration, measured by a vibrometer (Showa Sokki Inc., Model-2403) on the top plate of the dewar before and after the cryocoolers were turned on. As the operation of GM cryocoolers were very stable, measurements were taken on only several occasions and the figure is representative. The amplitude of the noise doubled when the cooler was turned on but was still only about  $1 \mu\text{m}_{p-p}$ , which is quiet enough to measure magnetic fields of the brain by MEG.

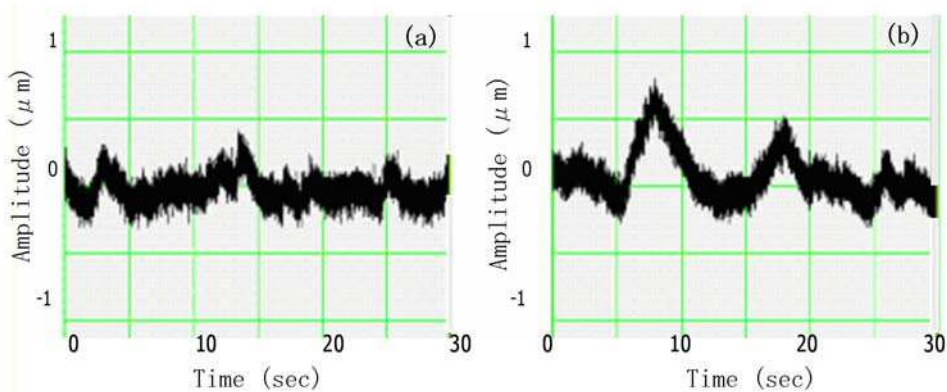

Fig. 4. Vibration on the top plate of the dewar when the cryocoolers were (a) not in operation and (b) in operation.

## 5. Performance of the HCS with an experimental MEG (Takeda et. al., 2009)

Fig. 5 is a photograph of the setup of the HCS on an operation MEG (PR2440 440 CH system, Yokokawa Electric Co. Ltd., Tokyo; Takeda et. Al., 2004). In the MEG, sensors are located at 300 points over a head and seventy of them are vector sensors. They are distributed roughly equal and mean distance between the sensors are about 20 mm. The total sensor number is 440. All the vector sensors are made by axial type gradiometers. Sensors for Z direction (the axial direction) are two oppositely wound circles and the sensors for X and Y direction are two oppositely wound squares. The areas of the squares are smaller by some 10 %, but the gain is tuned to make the output voltage to be comparable. The system noise is lower than  $9\text{fT}/\sqrt{\text{Hz}}$  and a bit better than common MEG systems. EEG can be measured simultaneously up to 64 CH. There are also 64 external input lines which enables flexible trigger set up.

A special dewar is developed which has a long insert to prevent invading heat from outside of the dewar. The insert is divided into two and has narrow gap to let the helium gas, whose temperature is about 40 K, flow through the gap and the neck tube of the dewar getting rid of the heat invading into the dewar.

The magnetically shielded room (Daido Plant Industries Co., Ltd.) has three permalloy layers with 2 mm thick each and 5 mm thick aluminum layer. Its inner size is 3000 x 3920 x 2900 (width x depth x height). The shielding factors are 60 dB at 0.1Hz, 82 dB at 1Hz and 100 dB at 10 Hz. There is a hole 400 x 600 (width x height) with a long sleeve that enables image projection through it.

We put the TT through a magnetically shielded room (MSR) wall and firmly fixed it to the MSR to reduce vibration generated by the GM cryocoolers. The hole of 100 mm diameter that lets the TT penetrate the MSR is covered by a permalloy box (PB) to reduce invasion of magnetic noise into the MSR from the environment. It was confirmed that the hole did not add any detectable magnetic noise.

The cryocoolers are attached to the base of a cold chamber, which is placed on a mount made of aluminium frame shown at the right. The TT is connected to the cold chamber with a welded bellows, which considerably reduces the transfer of vibrations generated by the GM cryocoolers to the TT. The cryocoolers are covered with a small and simple MSR to reduce magnetic and acoustic noise. Acoustic noise on the top plate of the dewar in the MSR, measured using a sound level meter (Yokokawa, LY20), was 34.7 dB. This is small enough for MEG measurements.

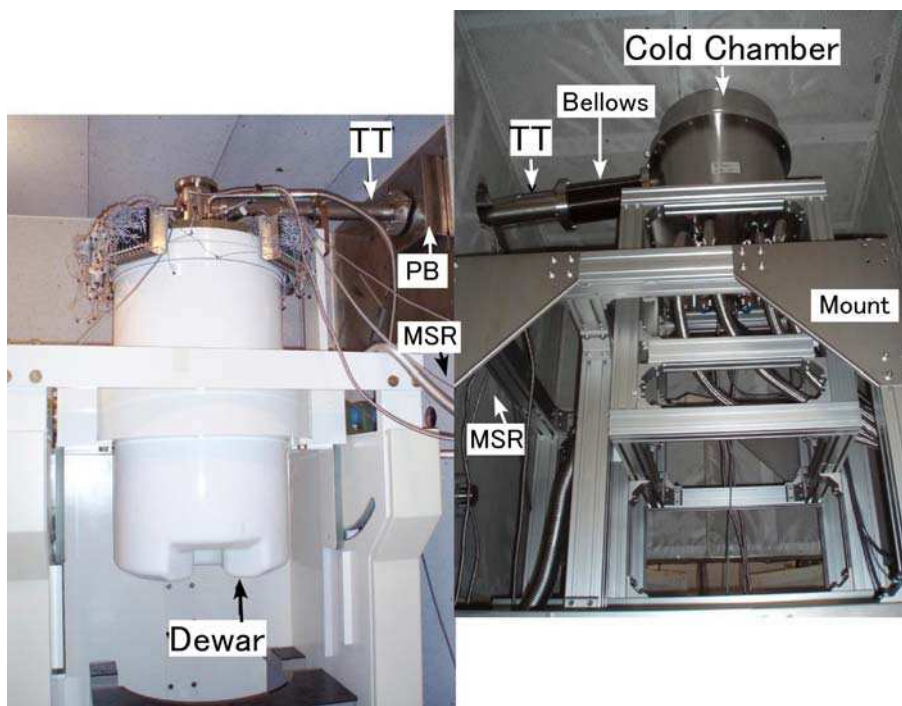

Fig. 5. Setup of HCS on MEG with 440 CH.

### 5.1 Helium circulation

Fig. 6 shows how the temperatures in different parts of the HCS changed during the first 3 days after HCS operation was started. As the MEG has 440 channels (CH) of SQUIDs, which is the largest number of sensor channels in the world, its dewar has a large heat capacity.

Though we could fill up the experimental dewar whose container volume was 5.6 l in 2 days starting from room temperature helium gas in the dewar as described in reference 3, it was estimated that we need to cool the system over two weeks to make liquid helium from the helium gas in the dewar by gradually cooling it with the GM cryocoolers. Thus, we decided to transfer LHe to the dewar on the third day.

Fig. 6a depicts the temperature change at various points in the HCS, where 1 - denotes the temperature at the second stage of the GM cryocooler, 2 - denotes the temperature of its first stage, 3 - denotes the temperature of pipe C in Fig. 1 after the refiner, 4 - denotes the temperature at pipe A near the condenser, and 5 - denotes the temperature of pipe B near the condenser. The figure shows that the temperature 1 dropped to about 5 K after 2.5 h from start up, and temperatures 2 and 3 dropped similarly to about 50 K after 9 h from start

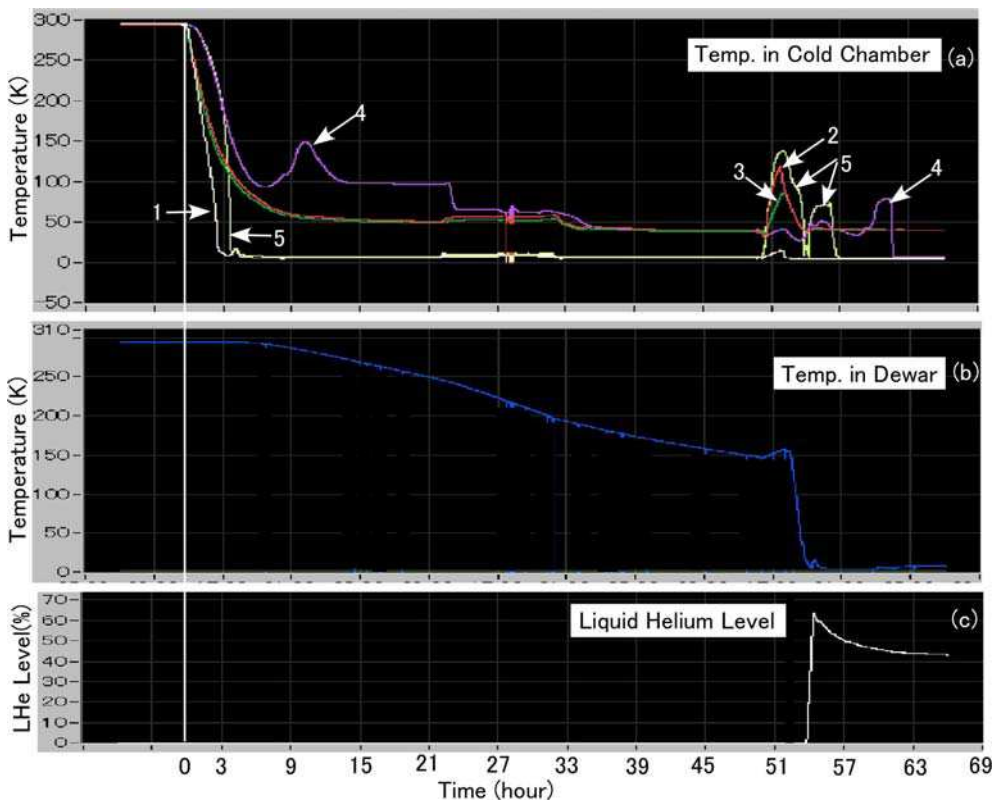

Fig. 6. Temperature change at various points in HCS from start up of HCS for 3 days (a); 1: at second stage of cryocooler, 2: at first stage of cryocooler, 3: at pipe C in Fig. 1 near cryocooler, 4: at pipe A, 5: at pipe B; (b) temperature change in the dewar, and (c) change of liquid helium level in dewar.

up. The temperatures 4 and 5 also descended similarly for 3 h after start up. While 5 continued to descend for one more hour after that time and dropped to about 5 K, 4 started to ascend from about 100 K at 6 h from start up to about 150 K at 10 h from start up. This is probably caused by warm helium gas sucked from the dewar through pipe B. Temperature 4 suddenly dropped from about 100 K to about 60 K at 22 h from start up, when we estimated partial liquidation started in the condenser. Temperatures 2, 3 and 4 gradually decreased as the dewar became cool, as shown in Fig. 6b.

Interesting temperature changes occurred after liquid helium was transferred at 50 h from start up. The flow of relatively warm helium gas from the dewar pushed up the temperatures at 2, 3 and 5 from 50 to 53 h, when cooling of the dewar finished and liquid helium began to accumulate in the dewar. The lower panel shows the liquid helium level in the dewar and indicates accumulation of LHe was completed in about 0.5 h, after which it decreased rapidly for 9 h to cool the dewar. Temperature 4 increased slightly and then suddenly dropped from about 70 K to 4 K at about 61 h after start up, which indicates helium liquidation continuously maintained and circulation of helium began at that time.

In the experimental setup used to measure the performance of the HCS before its installation, there was an additional heater at the bottom of the experimental dewar, which was used to measure the residual capacity of the cryocoolers to maintain the level of the

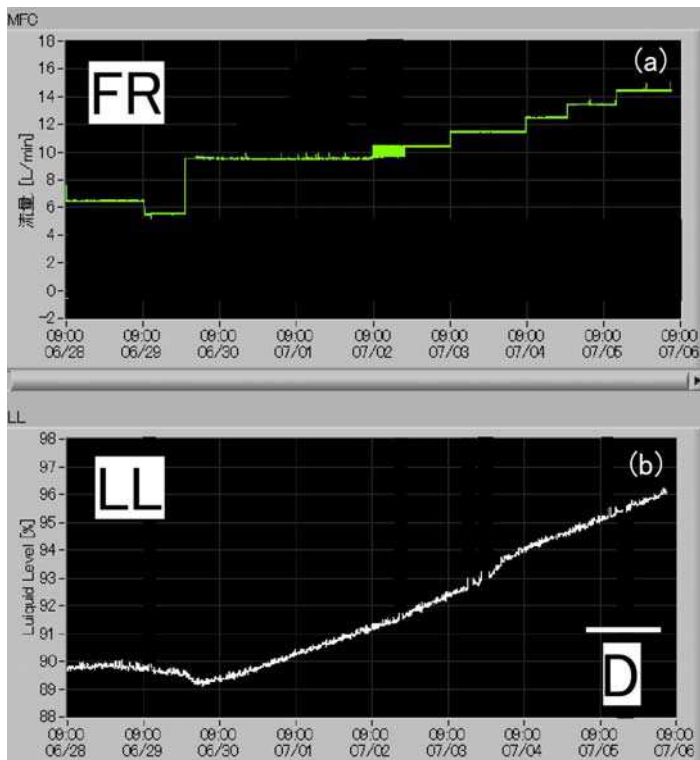

Fig. 7. Flow rate (FR) of the 40 K helium gas was changed for 8 days (a), and resulted in the change of liquid helium level (LL) in the dewar (b).



LHe. This capacity was found to be 1.1 W. When the TT was not attached to the dewar, about 35.5 l/D of helium evaporated from the dewar, as estimated by supplying 1.1 W of heat to the LHe. Therefore, it was confirmed that at least 35.5 l/D of LHe could be re-liquefied in the experimental system. This amount is adequate for nearly all the existing MEG systems, which require about 10 l/D.

In the real situation, more heat would be flowing from the inserted TT into the dewar. Fig. 7 shows the change of LHe level in the dewar (Fig. 7b) according to the change of HeG flow rate at the neck tube of the dewar (Fig. 7a). This means that the helium level decreased when the flow rate was below 6 l/min and increased when the flow was over 10 l/min. As the time constant of the change of the liquid helium level (LL) is very long, the dependence of the LL on helium gas flow rate (FR) is not clear from Fig. 3b. Later, it was determined by several supplemental experiments that 7 l/min is about the minimum flow rate to maintain the liquid helium level for this system. It was also estimated that the HCS can increase the LHe by 2.1 l/D at most in this system.

After the dewar is filled with LHe, we need not add any LHe to the dewar for one year during normal operation. As the GM cryocoolers require regular maintenance once a year, the cryocoolers were warmed up to 300 K by heaters attached to the condenser (with a capacity of 3 W) and on two refiners (each with a capacity of 200 W) for about 10 h. The temperature was kept at about 300 K by controlling the heater with a computer (Fig. 8a). As heat was added to the HCS, the liquid helium evaporated completely in 2 days, as shown in Fig. 8c. The temperature of the dewar began to increase half a day after the final evaporation of the liquid helium. It took about 3 days to warm up the dewar to room temperature (Fig. 8b). Vacuum pumping of the dewar's vacuum layer was done from the fifth to eighth day for about 3 days. The maintenance was performed during the sixth day, and the liquid helium transfer was done on the eighth day (Fig. 8c).

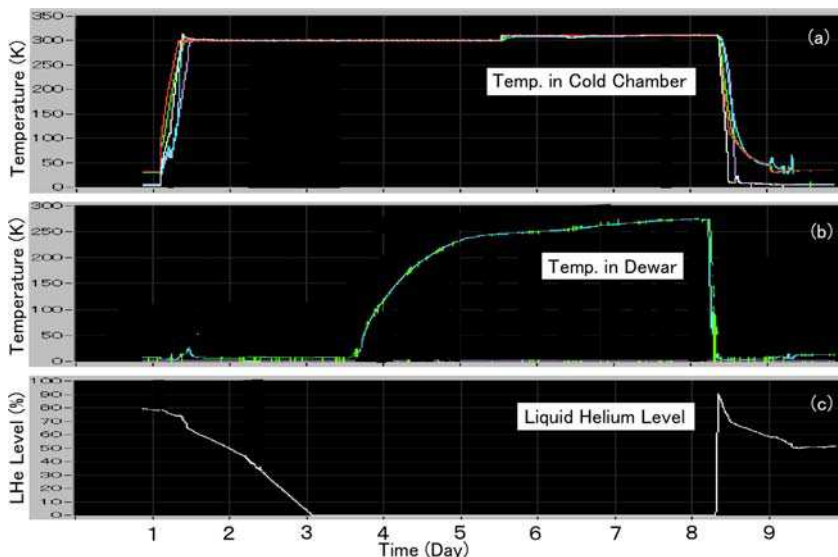

Fig. 8. Temperature change at various points in HCS during cryocooler maintenance for 8 days (a), temperature change in the dewar (b), and change of liquid helium level (c).

## 5.2 Noise reduction

Fig. 9a shows the locations of 14 representative CH (closed dots) of the 440 CH MEG sensors spread almost evenly over the head, viewed from above the head with the sensor locations projected onto a horizontal plane. The up direction is the direction of the subject's forehead. Because the data from those 14 channels indicate the general characteristics of the noise in all the MEG sensors, these channels' data will be used in the following paragraphs.

Fig. 9b depicts the temporal wave of magnetic noise measured by the MEG, where the noise added by the installation of the HCS is removed as much as possible. Although most channels show acceptable noise levels, several channels, such as channels 96 and 384, have a bit larger (apparently 50 Hz) power line noise, which will be suppressed in the near future by further improvements.

Fig. 10a depicts the amplitude spectrum of magnetic noise measured by the MEG before the HCS was installed. The noise levels are roughly below  $10 \text{ fT}/\text{Hz}^{1/2}$  for 2-1000 Hz, similar to that in common MEGs. The amplitude spectrum has a typical  $1/f$  noise pattern below 2 Hz. It is below  $35 \text{ fT}/\text{Hz}^{1/2}$  at 1 Hz and  $170 \text{ fT}/\text{Hz}^{1/2}$  at 50 Hz, which is the power supply frequency.

Fig. 10b depicts the amplitude spectrum of magnetic noise measured just after the HCS was installed. It shows noise of about  $200 \text{ fT}/\text{Hz}^{1/2}$  at 1 Hz, which was apparently produced by the vibration of the TT driven by the GM cryocoolers. The GM cryocoolers produce a strong 1 Hz vibration when the compressed helium gas expands adiabatically in the cryocoolers. The amplitude spectrum also has a very large noise spectrum at other frequencies, especially at the higher harmonics of 1 Hz and 50 Hz.

To reduce the noise levels, thick plates were placed between the aluminium frames where the cryocoolers are mounted to act as stiffeners. Fig. 10c shows the amplitude spectrum of magnetic noise measured after the modification of the cryocooler stage. The magnitude of the amplitude spectrum at 1 Hz was reduced considerably, to about  $100 \text{ fT}/\text{Hz}^{1/2}$ . However,

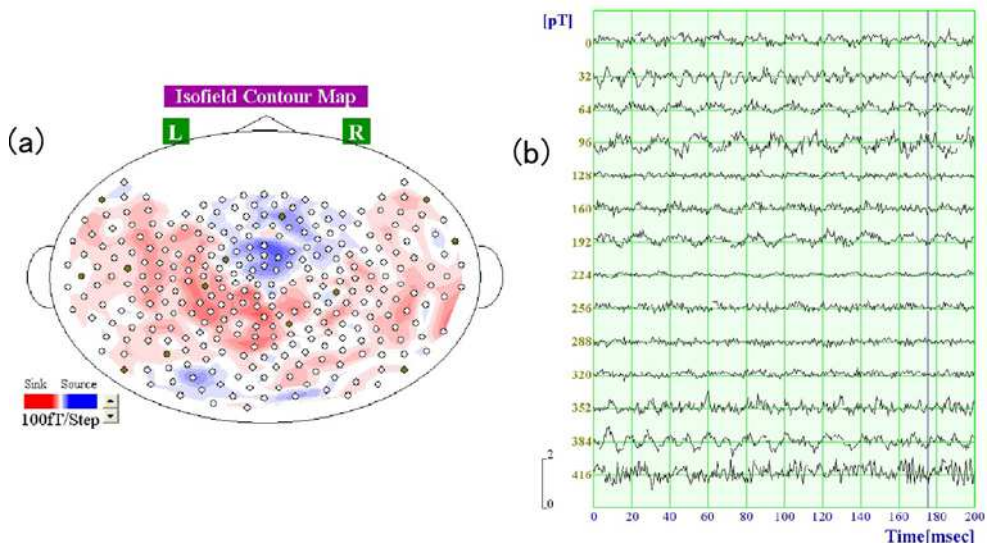

Fig. 9. The location of selected 14 CH sensor channels (a), and their typical noise (b).

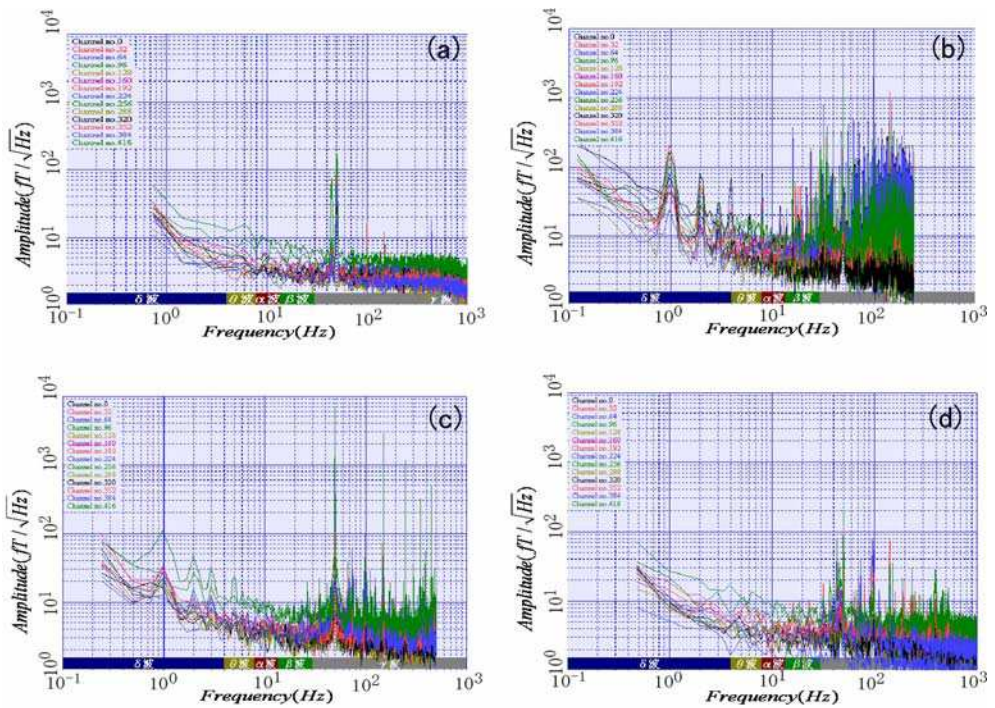

Fig. 10. Noise amplitude spectra of the selected 28 channels of the system, (a) before HCS installation, (b) just after HCS installation, (c) after stiffness increase of the HCS mount, and (d) after grounding improvements.

there remained considerable noise caused by the HCS, especially at 50 Hz and its higher harmonics. The noise amplitude at 50 Hz was about 7 pT/Hz<sup>1/2</sup>, which was more than ten times of that in Fig. 10a.

Various improvements were made to reduce the noise added by the HCS. As the details of those measures are not in the scope of this paper, they are not explained here. The most effective measure was to reduce current leak from the power supplier to the TT by various methods in the electrical grounding of the MEG and the HCS. Fig. 10d depicts the amplitude spectrum of magnetic noise measured after the improvements. The noise level at 1 Hz is reduced to less than 30 fT/Hz<sup>1/2</sup>, which is a bit smaller than that in Fig. 10a. The noise level at 50 Hz is reduced to 200 fT/Hz<sup>1/2</sup>, which is still a little bit bigger than before HCS installation. There are also slight noise increases in the range of 30-50 Hz and at the higher harmonics of 50 Hz.

Though there are small noise increases, it can be said that noise level is roughly the same as before the HCS installation. As it is common to use a band pass filter of 1-40 Hz in the MEG measurement to get rid of power supply noise, which is very difficult to eliminate completely, the remaining noise has virtually no negative effect. Fig. 10a shows the noise level after the band pass filter was applied (a 6th-order Butterworth filter with a 1-40 Hz band). There could be found no prominent noise there. Fig. 10b shows the amplitude

spectrum of the remaining noise. It clearly shows that there remains virtually no influence from the noise produced by the HCS after the band pass filter is applied.

Acoustic noise in the hollow of the dewar, measured using a sound level meter (Yokokawa Ltd., DT-805), was 34.7 dB while the cryocoolers were running. There is a hole (300 mm x 250 mm; width x height) in our MSR to allow visual image projection through the hole by a liquid crystal projector, and the acoustic noise level could be lowered to 33.0 dB if this hole was closed. This sound noise level is small enough for MEG measurements.

### 6. Control system of the HCS

Fig. 11 shows schematic gas flow (a) and control diagram (b) of the HCS. Evaporated helium gas in the dewar is absorbed to the condenser and liquefied. It then drops to the dewar by the gravity.

The controller of the HCS uses compact Field Point (cFP-2020 : National Instrument) and the software is based on LabVIEW Real-Time. The cFP has three RS-232C ports and one RS-485 port. External module has 8 CH A/D (cFP-AI-110) and two 8 CH relay modules (cFP-RLY-421).

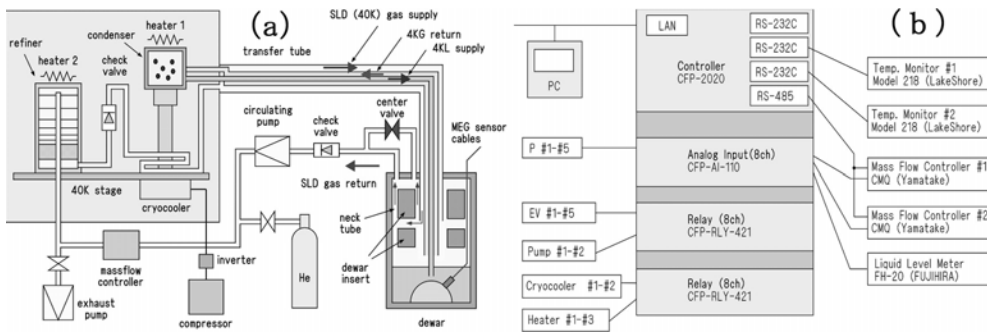

Fig. 11. Block diagram of the gas flow in the HCS (a), and the control interfaces of various control elements in the system (b). P: pressure gauge, EV: electromagnetic valve.

Fig. 12a shows the gas flow control system which has several electric valves, mass flow controller and several pressure gauges. Fig. 12b shows the temperature monitors, liquid helium level meter and PC for the control of gas flow system and monitoring of the whole HCS.

### 7. Installation the HCS to a commercialized MEG

The most serious problem remained to be improved was that the HCS had a TT insert tube with diameter of 3/2 inches. As all the existing MEGs have 1/2 inch insert hole to refill liquid helium, extensive redesign or reconstruction of MEGs was required to use the developed HCS. Hence, we have tried to reduce the diameter of the TT insert tube to 1/2 inch to avoid the requirement. Though it was very hard to reduce the diameter of the multi-pipe TT insert tube to 1/3, we managed to achieve the goal. Once we have succeeded to develop a TT with standard insert tube diameter of 1/2 inch, there is no need to modify the MEG per se. So we could easily install the HCS on a commercialised MEG produced from Yokokawa Electric Corporation Inc. (PQ1160C) as shown in Fig. 13.



Fig. 12. Hardware of the gas control system of the HCS (a), and computer to control the gas flow together with temperature monitors and Liquid helium level meter (b).

As the MEG has been installed in a magnetically shielded room (MSR) about a year ago without any plan to add a HCS to it, there isn't any proper hole to let through the TT just behind or left/right side of the MEG, which enables to use simple straight pipe TT same as



Fig. 13. Multi-pipe TT of the HCS installed on the commercialized MEG (PQ1160C, Yokokawa Electric Cor. Inc., Japan). As the TT has 1/2 inch insert tube, there was no need to modify the MEG to install the HCS. TT is twisted twice to use the ventilation hole located upper light to get through the MSR. It is tilted 5 degrees to get the LHe drop to the dewar.

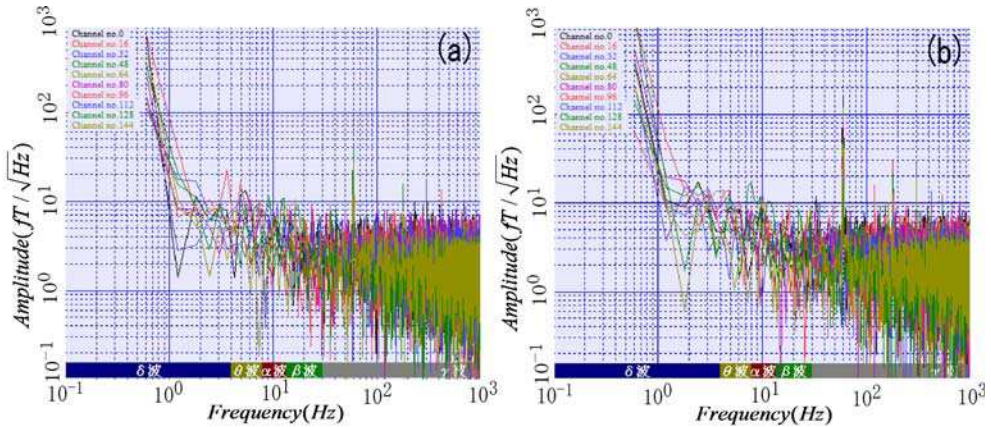

Fig. 14. Noise amplitude spectra of the selected 10 channels of the system (Yokokawa, PQ1160C); (a) before HCS installation, (b) after installation. There isn't any noticeable difference. Installation of the HCS is successful.

used in an experimental MEG at the University of Tokyo. It was rather difficult to make a suitable hole through the existing MSR, because it requires extensive modification of the MSR. We planned to utilize the ventilation hole located right upper in the MSR, whose diameter was 170 mm. To use the hole, we designed a new TT with reduced diameter of 60.5 mm from 76.3 mm used for the experimental MEG. We also vented the TT twice to use the hole as shown in Fig. 5. The TT is tilted about 5 degrees to let the LHe flow by the gravity.

It took about a week to install the HCS on the MEG in May, 2011. HCS can increase the LHe by about 3 liters per day and add no extra noticeable noise in the MEG noise recording. As the compressor of the cryocooler is located another room next to the MEG room and cryocooler is located outside of the MEG room, there is no noticeable additional acoustic noise.

Fig. 14 shows noise amplitudes of the MEG (Yokokawa, PQ1160C) at the Nagoya University before (a) and after (b) the installation of the HCS. There is no noticeable noise difference in the two measurements. So, it can be said the installation of the HCS has no negative effect on the MEG measurements and eliminate necessity of liquid helium transfer for at least a year.

## 8. Discussion and future HCS

MEGs would be cheaper to run if high-Tc SQUIDs, cooled by liquid nitrogen, could be used. Unfortunately, high-Tc SQUIDs are currently too noisy, so costly LHe systems must be used. The developed HCS would reduce the cost to run MEGs because almost none of the He, a rare material, is allowed to escape into the atmosphere, eliminating the hazardous task of replacing lost LHe, which requires trained personnel. Also, although helium itself is not a major pollutant, because our system consumes less energy, it is indirectly more environmentally friendly.

Since we wanted to do maintenance including vacuum pumping of the dewar, we warmed up the dewar completely. However, the vacuum level of the dewar could be sustained low enough for several years. Thus, we could skip vacuum pumping, and can perform the maintenance by just warming up the cryocoolers. We will warm the cryocoolers overnight,

replace wearing parts of the GM cryocoolers the next day, cool the cryocoolers down overnight during the following night, and resume circulation on the third day. From Fig. 4 data, it is estimated that about 60 % of the liquid helium in the dewar is lost into the atmosphere for 48 h. Hence, about 40 l of liquid helium and about 48 h of time are necessary for the maintenance.

In the experimental MEG at the University of Tokyo, the magnetic noise level between 2 and 40 Hz is below 10 fT/Hz<sup>1/2</sup>, which is about the same as the noise level before the HCS is installed. Although the noise level at 50 Hz was about 170 fT/Hz<sup>1/2</sup> before the HCS installation, the noise level of 200 fT/Hz<sup>1/2</sup> at 50 Hz is a little bit bigger after HCS installation. There is also a slight noise increase in the range of 40-50 Hz and at the higher harmonics of 50 Hz. However, the noise level of the Nagoya university is roughly same between before and after the installation of the HCS (Fig. 14). So, it can be said, the HCS has no bad influence for the commercialized MEGs.

The acoustic noise level was 34.7 dB at the center of the head hole in the MEG dewar in the MSR. The noise level is about the same as before the installation and quiet enough to perform ordinary MEG measurement.

Our system can produce at least 35.5 l of LHe per day from the evaporated helium with two 1.5W at 4.2K GM cryocoolers (Takeda et. al., 2008). The total cooling capacity of the system was estimated to be about 2.4 W. We are still improving our system and hope to be able to produce 10 l/D of LHe using only one 1.5 W GM cryocooler in the near future.

Though we designed our HCS for MEGs, the HCS, with its advantages, can be used for other devices in the field of cryogenics. Several low temperature physical property measurement devices, which measure magnetic or electrical properties at low temperatures by cooling materials with liquid helium, could serve as promising applications. We are now developing HCSs suitable for such purposes.

## 9. Summary

We have developed a helium circulation system that uses two 1.5 W at 4.2 K GM cryocoolers and has dual helium streams; one to collect evaporated HeG immediately and return it as liquefied helium to the Dewar, and the second to use higher temperature HeG (approximately 40 K) to cool the Dewar. We installed this mechanism on an experimental MEG system with 440 CH measurement SQUIDs (Yokokawa PR2440) and operated it for three and a half years. We also installed a new model on a real commercialized MEG system (Yokokawa PQ1160C) at the Nagoya University and operated it for five months.

It has been confirmed that magnetic and acoustic noises added by installing the HCSs have no problem for MEG measurements.

The HCS can increase the level of liquid helium by at least 3 l per day with the Yokokawa PQ1160C. Without needing to perform Dewar pumping, regular cryocooler maintenance can be done in 2 full days, losing approximately 40 l of liquid helium in the process. The maintenance cost (electricity charges and cryocooler maintenance fee) of the MEG has been reduced to be less than one-tenth of the previous cost (liquid helium and maintenance fees).

## 10. References

Ackermann RA, Herd KG, Chen WE (1999). Advanced cryocooler cooling for MRI system, *Cryocooler*, Vol. 10, pp. 857-67.

- Kang Y et. al. (1998). Cryocooled SQUID system, *The Journal of Japan Biomagnetism and Bioelectromagnetics Society*, Vol. 11 No. 1, pp. 15-16 (in Japanese).
- Shigi T et. al. (1982). Handbook of cryogenics, in Japanese translated from VDI: LEHRGANGSHANDBUCH KRYOTECHNIK by Klipping G et. al., Uchida Rokakuhoshinsya, pp. 135-136.
- Takeda T, Takae T (2001). A liquid helium circulation system for biomagnetometers, *Biomag 2000*, pp. 951-952.
- Takeda T, Owaki T, Haruta Y, Uehara G (2004). Characteristics of a 440ch MEG system with vector sensors, *Biomag 2004*, pp. 640-641.
- Takeda T, Horinouchi H (2005). A liquid helium circulation system for MEG, *Transactions of the Cryogenics Engineering Conference-CEC*, Vol. 51, pp. 427-432.
- Takeda T, Okamoto M, Atsuda K, Katagiri K (2008). An efficient helium circulation system with small GM cryocoolers, *Cryogenics* Vol. 48, pp. 6-11.
- Takeda T, Okamoto M, Atsuda K, Katagiri K (2009). Performance of a Helium Circulation System for a MEG, *Cryogenics*, Vol. 49, pp. 144-150.
- Takeda T, Okamoto M, Miyazaki T, Katagiri K (2011). Performance of the Helium Circulation System on a Commercialized MEG, *Transactions of the Cryogenics Engineering Conference-CEC*, Vol. 57, in print.
- Wang C (2001). Helium liquefaction with a 4K pulse tube cryocooler, *Cryogenics*, Vol. 41, pp. 491-496.



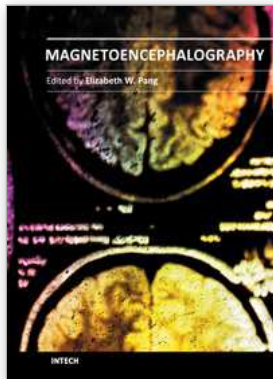

## **Magnetoencephalography**

Edited by Dr. Elizabeth Pang

ISBN 978-953-307-255-5

Hard cover, 252 pages

**Publisher** InTech

**Published online** 30, November, 2011

**Published in print edition** November, 2011

This is a practical book on MEG that covers a wide range of topics. The book begins with a series of reviews on the use of MEG for clinical applications, the study of cognitive functions in various diseases, and one chapter focusing specifically on studies of memory with MEG. There are sections with chapters that describe source localization issues, the use of beamformers and dipole source methods, as well as phase-based analyses, and a step-by-step guide to using dipoles for epilepsy spike analyses. The book ends with a section describing new innovations in MEG systems, namely an on-line real-time MEG data acquisition system, novel applications for MEG research, and a proposal for a helium re-circulation system. With such breadth of topics, there will be a chapter that is of interest to every MEG researcher or clinician.

### **How to reference**

In order to correctly reference this scholarly work, feel free to copy and paste the following:

Tsunehiro Takeda, Masahiro Okamoto, Takashi Miyazaki, Naoki Morita and Keishi Katagiri (2011). Helium Circulation System (HCS) for the MEG, Magnetoencephalography, Dr. Elizabeth Pang (Ed.), ISBN: 978-953-307-255-5, InTech, Available from: <http://www.intechopen.com/books/magnetoencephalography/helium-circulation-system-hcs-for-the-meg>

**INTECH**  
open science | open minds

### **InTech Europe**

University Campus STeP Ri  
Slavka Krautzeka 83/A  
51000 Rijeka, Croatia  
Phone: +385 (51) 770 447  
Fax: +385 (51) 686 166  
[www.intechopen.com](http://www.intechopen.com)

### **InTech China**

Unit 405, Office Block, Hotel Equatorial Shanghai  
No.65, Yan An Road (West), Shanghai, 200040, China  
中国上海市延安西路65号上海国际贵都大饭店办公楼405单元  
Phone: +86-21-62489820  
Fax: +86-21-62489821

© 2011 The Author(s). Licensee IntechOpen. This is an open access article distributed under the terms of the [Creative Commons Attribution 3.0 License](#), which permits unrestricted use, distribution, and reproduction in any medium, provided the original work is properly cited.