

Synthetic Natural Gas (SNG) from coal and biomass: a survey of existing process technologies, open issues and perspectives

Maria Sudiro and Alberto Bertucco

*Department of Chemical Engineering (DIPIC), University of Padova
Italy*

1. Introduction

Natural gas is a well known energy carrier. It is often used for producing heat and power, but can also be applied as a fuel in the transport sector. The production of synthetic natural gas (SNG) from coal or biomass is an interesting opportunity for both exploiting coal and biomass, and for replacing oil products for transportation and other uses.

SNG has many important advantages with respect to other syngases: it can be transported efficiently and cheaply using existing natural gas pipelines and distributing networks, it is an easily convertible feedstock, both in natural-gas combined-cycle power plants and in petrochemical facilities, it can count on a high social acceptance with respect to coal, and it can be stored underground, enabling efficient operation throughout the year independently of a fluctuating demand.

Unfortunately, the commercial deployment of technologies for the production of SNG is currently constrained by technical barriers, so that more research is required before extensive applications on the industrial scale can be achieved. An important issue to be addressed is the strong exothermicity of the methane formation reactions, so that conventional fixed-bed catalytic reactors cannot be safely used (Sudiro et al., 2009).

Following the 1970s energy crisis much work has been initiated in the US on coal-to-SNG: SNG process technologies and catalysts were developed and tested extensively. But most have been cancelled in the 1980 because of the changing energy picture. One industrial plant has actually been realized in North Dakota, which began operating in July 1984 and today produces more than 54 billion standard cubic feet of synthetic natural gas annually (1.53 billion Nm³/yr). Coal consumption is about 6 million tons each year. The heart of this plant is a building containing 14 gasifiers (www.dakotagas.com).

Nowadays, the rise of natural gas prices have created a strong interest in producing SNG from the cheaper and much more abundant coal. A renewed interest in basing more energy consumption on coal and petcoke has resulted in a revival of several older technologies that have been enhanced to improve efficiency and to lower investment cost.

Methanation is used as the final syngas purification step in the production of ammonia, but methanation for SNG production is more complex. The main industrial application of methanation has been the removal of CO from H₂-rich feed gases in ammonia plants. With

the aim of producing SNG the methanation reaction changes from a gas cleaning step to the main synthesis process. Methanation for SNG production is more complex because it involves much higher concentrations of CO and CO₂. The high reaction heat results in large potential adiabatic temperature increase that may cause catalyst sintering and possibly leads to carbon particles formation.

The methanation catalysts should be active and stable at both high and low temperatures for the methane production processes because this is the key problem in optimizing the coal-based SNG methanation process. The optimal recovery of the reaction heat from the methanation reaction is also critical (www.syngasrefiner.com/SNG/agenda.asp).

2. The methanation process

2.1 Principles of methanation

The principle of catalytic synthetic production of methane from carbon monoxide and hydrogen was discovered in 1902 by Sabatier and Senderens (Ulmann, 1989). It is described by the CO methanation reaction:



Carbon dioxide can also be converted to methane according to the following reaction



Both reactions are linked by the water gas shift conversion, which is always observed simultaneously whenever active catalysts are used:



A number of observations, reported in Ulmann (1989), indicate that the transformation of carbon dioxide to methane is initiated by a reverse shift conversion reaction with hydrogen to yield carbon monoxide and steam. The carbon monoxide formed then reacts to yield methane.

Both reactions (1) and (2) are strongly exothermic: -206 kJ/mol and -165 kJ/mol, respectively. Also low temperature and high pressure are required to achieve high methane yield.

Interest in SNG production is concentrated on the gasification step, that may yield high methane content in the raw gas. This is possible, for instance, with Lurgi pressure gasification of coal, especially when gasification pressures of 80-100 bar are applied, as has been successfully tested in recent years (Ulmann, 1989).

Methanation processes with little methane in the raw syngas suffer principally from:

1. high exothermic heat release during methanation;
2. need of handling very large quantities of synthesis gas (four to five volumes of dry synthesis gas yield one volume of methane);
3. high proportion of steam formed during methane synthesis, which limits the directly achievable SNG quality in wet methanation steps.

2.1 Earlier methane synthesis plants

The oil crisis in the 1970s intensified the development of lignite and coal gasification processes coupled with SNG production; United States, Germany and Great Britain were involved in these activities (Kopyscinski et al., 2010). A few demonstration and pilot plants were constructed during this period but only one commercial plant was built (in North Dakota, as reported above).

Four types of methane synthesis process have been developed for commercial operation (Ulmann, 1989). They limit the temperature increase by recycling of reacted gas or steam dilution, or by special techniques such as isothermal reactors or fluidized beds, each with indirect cooling by evaporating water.

A first configuration is the "methane synthesis plant with hot recycle", in which a two-stage recycle system with a final countercurrent-cooled reactor is used, as shown in Figure 1. In this process the syngas, after being preheated, is routed to the first methanation reactor with a part of the stream coming from the exit of the second reactor. Then the outlet of the first methanator is cooled and sent to the second reactor step with a part of fresh synthesis gas; these two reactors are run adiabatically. The outlet of the second reactor is cooled and the part not recycled to the first methanator is sent, after a cooling section, to the final reactor which is a countercurrent cooling reactor. The two streams from the two adiabatic reactors are cooled using boiler feed water (BFW) in order to produce saturated steam at 10 bar. The SNG produced is then cooled, dried and recovered.

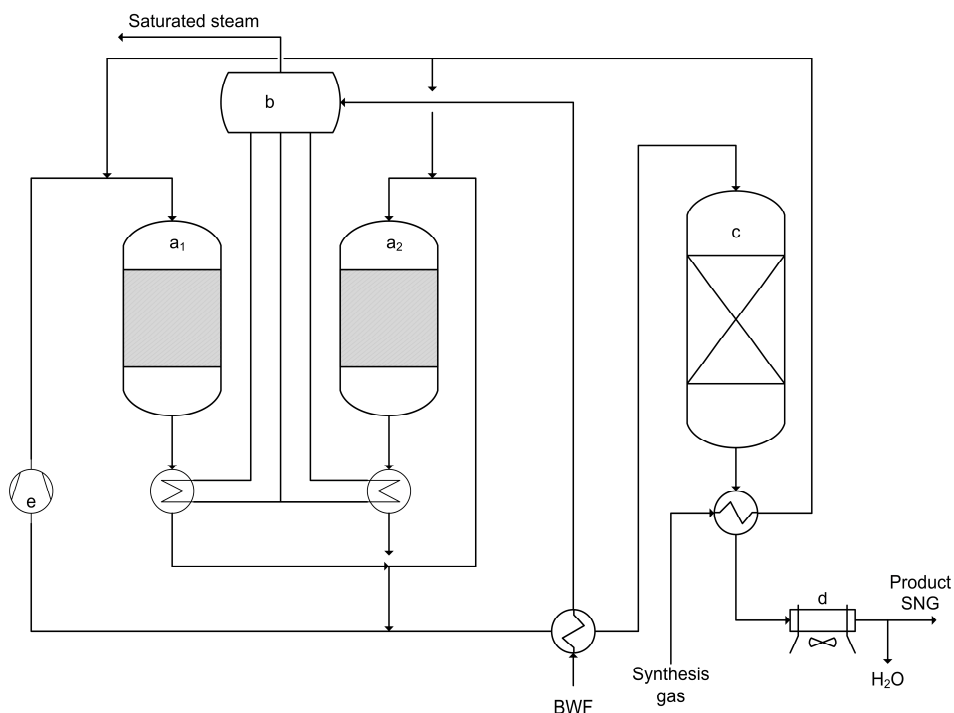

Fig. 1. Recycle methane synthesis: a₁, a₂) recycle reactors; b) steam drum; c) countercurrent cooling reactor; d) air-cooled cooler; e) hot recycle compressor, adapted from Ulmann, 1989

This process was originally designed with a recycle quantity such that 500°C is not exceeded at the outlet of the adiabatic reactors. Current systems are available working at maximum temperatures up to 650°C. Inlet temperatures are around 300°C, which is also the operating range of the recycle compressor. An advantage of the hot recycle is that water vapour formed during the methanation reaction is not condensed.

A second example of methane synthesis process is the “steam quenching methane synthesis” and is sketched in Figure 2. For synthesis gases with low H₂/CO molar ratio, steam must be added to prevent carbon particle formation. For optimum results, the required quantity of steam is mixed with a portion of the feed gas in such a way that the temperature in the first methanation step is kept within allowable limits and, after heat removal, a further portion of the feed gas is admitted to the first intermediate product gas stream as quenching stream. The quenching procedure after cooling is repeated until all the feed gas is consumed. Thus, a multistage concept results, depending on the inlet gas composition, as shown in Figure 2. With the addition of steam, the equilibrium composition of any intermediate product gas is not favourable enough to enable direct production of specification-grade SNG in a wet methanation step. The removal of carbon dioxide, therefore, is followed by a final, dry methanation stage.

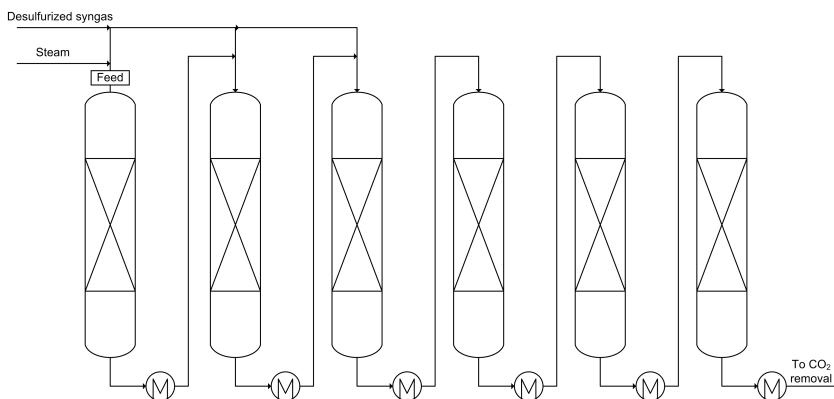

Fig. 2. Scheme of an example of multi stage quenching system, adapted from Ulmann, 1989, where a fixed bed reactor followed by a cooling section is repeated until the feed is consumed

A third example of methane synthesis is the “fluidized-bed methanation”. The Comflux® process is a plant of this type, in which feed gases of unfavorable composition are sent, with little or no addition of steam, into a cooled fluidized-bed reactor in one step. The dangers of carbon formation, catalyst deactivation by high carbon monoxide partial pressure, and excessive catalyst consumption by the fluidized-bed process are said to have been overcome, and operation up to 60 bar has been demonstrated successfully in the pilot plant (Ulmann, 1989).

A final example of methane synthesis is the “isothermal operation”. By increasing the allowable temperatures for methanation catalysts, methane synthesis can be performed by a once-through method in quasi-isothermal reactors cooled by evaporating water which generates saturated steam. Under favorable conditions, such systems produce specification-grade SNG in only one catalytic step (Ulmann, 1989). Any traces of sulfur compounds must be eliminated carefully in order to avoid catalyst poisoning.

3. SNG: state of the art

3.1 Existing process technologies

Methanation reactor technologies can be classified into three categories: fixed bed, fluidised bed and other types of reactor.

About fixed bed methanation the following processes have been developed: Lurgi, Tremp™, Conoco/BGC, HICOM, Linde, RMP and ICI/Koppers.

In the 1930s Lurgi developed a methanation unit including two adiabatic fixed bed reactors with internal recycle. One pilot plant was designed and erected by Lurgi and Sasol in Sasolburg (South Africa) and another pilot plant in Austria, erected by Lurgi and El Paso Natural gas Corporation. The methanation unit of these two pilot plants consisted of two adiabatic fixed bed reactors with internal gas recycle. Based on the results obtained by Lurgi and Sasol, the first and only commercial SNG from coal plant (Great Plains Synfuels Plant) was commissioned in North Dakota USA (Kopyscinski et al., 2010).

The Tremp™ process (Topsoe's Recycle Energy-efficient Methanation Process) was developed by Haldor Topsoe's laboratory. This technology addresses the essential question of heat recovery in the most efficient manner by recovering the heat as high pressure steam. In order to apply such a heat recovery concept, it is essential to recover the reaction heat at high temperature. Due to the unique MCR-2X methanation catalyst, Tremp™ can operate at high temperatures, up to 700°C (Topsoe, 2009). This catalyst has the following advantages:

- recovery of reaction heat in the form of high pressure superheated steam to be used directly for turbine drive;
- low recycle ratio to ensure energy savings;
- reduced gas flow resulting in lower equipment cost.

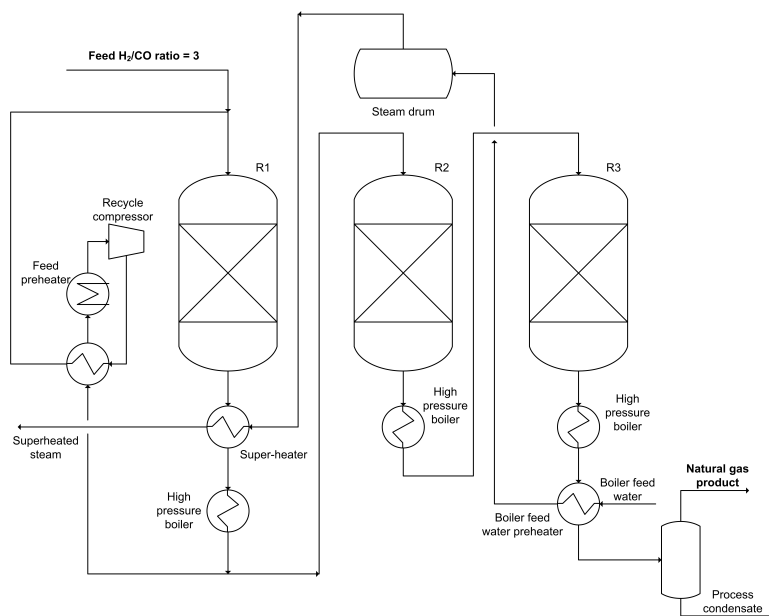

Fig. 3. Scheme of the Tremp™ technology, adapted from Topsoe, 2009

With reference to Figure 3 the process steps upstream the methanation unit are designed to provide a near stoichiometric ratio of hydrogen to carbon monoxide in the gas according to the methanation reaction (eq. 1). The exit gas from the first reactor is cooled in two steps where the first step serves to superheat the high pressure steam generated in the second step. After cooling, the gas enters the following methanation stages.

The CO methanation takes place in adiabatic reactors. The heat of the reaction results in a high temperature increase, and recycle is used to control this temperature rise in the first methanation reactor.

This technology is characterized by (Topsoe, 2009):

- low energy consumption for recycle;
- production of high pressure superheated steam;
- low investments;
- producing a natural gas compatible with pipeline specification, ensuring an easy access to distribution of the product.

Any recycle involves a loss of energy but the MCR-2X catalyst is a good choice to minimize the amount of recycle gas. This catalyst is stable and operable at low as well as high temperature (from 250 to 700°C).

The experience with operation of this technology dates back to 1978 and a substantial process demonstration has taken place ensuring that the technology can be applied. A semi-commercial process has been demonstrated in a plant producing 2000 Nm³/h of natural gas. However no industrial plants have been constructed until now. The project was closed down in 1981 for political change and lower energy prices (Undergaard, 2008). Presently Topsoe's TREMP™ technology has been approved for a US plant. This methanation technology was selected for use in Power Holding's coal gasification plant in Jefferson County, Illinois (USA). The plant will convert about 4 million tons per year of coal into pipeline-quality natural gas. Along with GE Energy and Lurgi, Haldor Topsoe has been selected as technology provider. It is expected the coal-to-gas plant will startup in 2010 (www.zeuslibrary.com).

In 1972 in Scotland (Westfield Coal Gasification plant) the first worldwide demonstration plant producing SNG from coal has been accomplished by ConocoPhilips and the British Gas Corporation (BGC), with a production of 59 Million Nm³/day. The methanation unit, consisting of a fixed bed adiabatic reactor with gas recycle, was connected to an existing Lurgi fixed bed gasifier and gas cleaning section was a Rectisol unit. Unfortunately, no plant data can be found (Kopyscinski et al., 2010).

A further development of the British Gas Corporation was the HICOM process in which shift and methanation are combined. In this type of process (see Figure 4) the syngas, after purification, is heated and saturated with hot water in a countercurrent flow packed bed. After that, the syngas is passed through a series of fixed bed reactors. The temperature is controlled by recycling the cooled product gas. Excess steam is added to the first methanation reactor to avoid carbon particle deposition. A part of the product gas from the main methanation reactors is recycled and the other part is passed through one or more low temperature fixed bed methanation reactors. In the last reactor the remaining CO and H₂ are converted to CH₄ and CO₂. Almost all the heat released from these reactions is used to generate high pressure steam except the one of the last reactor, which is applied to warm the saturated boiler feed water. With this type of configuration a bench-scale reactor for screening of catalysts and process conditions was erected, also a pilot plant was built where tests for about 2000h were

done. Finally, a semi-commercial scale plant was constructed at the Westfield Development Center but no data about these plants were found (Kopyscinski et al., 2010).

In the 1970s, Linde AG (Germany) developed an isothermal fixed bed reactor with indirect heat exchange. In this reactor the cooling tube bundles are embedded in the catalyst bed, so the reactor is able to produce steam from the exothermic reactions and a part of this steam can be added to the syngas at the inlet of the methanator in order to minimize the risk of carbon deposition. No information are available about the use of this type of reactor in SNG production (Kopyscinski et al., 2010).

A high temperature methanation without gas recycle was proposed by the Ralph M. Parsons Company (USA). This process, called RMP, consists of 4-6 adiabatic fixed bed reactors in series with intermediate gas cooling. The syngas is distributed in different ratios in the first four reactors (Figure 2 shows the idea of this process). Working pressures are between 4.5 and 77 bar and temperatures are in the range between 315°C (inlet) and 538°C (outlet). Data about gas composition of different tests were available whereas no data about the catalyst and reactor dimensions were published. After 1977 no more information about this project are available (Kopyscinski et al., 2010).

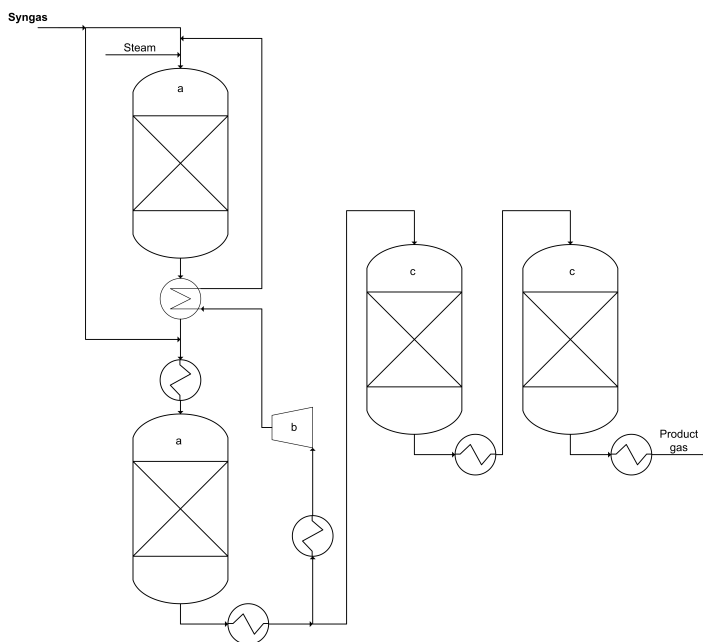

Fig. 4. Scheme of the HICOM process: a) main methanation stages, b) recycle compressor, c) non-recycle methanation stages, adapted from Kopyscinski et al., 2010

Similar to the RMP process, the Imperial Chemical Industries ICI (Great Britain) developed a catalyst and a high temperature once-through methanation process, using a catalyst with a high nickel content (up to 60%). This process consists of three adiabatic fixed bed reactors in series with intermediate gas cooling (see Figure 5), where it is possible to see that steam is

added to the second reactor in order to maintain the temperature below 750°C. On the basis of this scheme no large scale plant have been built (Kopyscinski et al., 2010).

About fluidised bed methanation several projects have been set forth. In the first project, started in 1952 by the United States Department of the Interior, one fixed bed and two different fluidised bed methanation reactors were developed, which were operated in total for more than 1000h. About this project no data are available after 1956 (Kopyscinski et al., 2010).

A second project, the Bi-Gas project, was initiated in 1963 by Bituminous Coal Research Inc. (USA) for producing SNG from coal, via gasification in a entrained flow gasifier. The methanation reactor developed within this project is a gas-solid fluidised bed reactor including a second feed inlet in the middle of the reactor and two in-tube heat exchanger. Experimental tests for about 2200h were done obtaining conversion of CO between 70 and 95%. After the last publication in 1979, no more reports on the Bi-Gas project have been found in the literature (Kopyscinski et al., 2010).

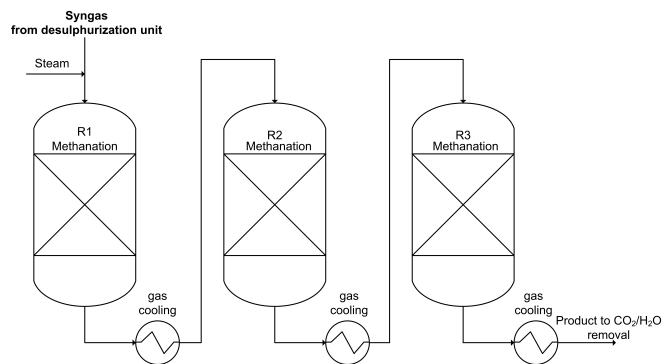

Fig. 5. Scheme of the ICI high temperature process, adapted from Kopyscinski et al., 2010

Finally, between 1975 and 1986, the Thyssengas GmbH and University of Karlsruhe (Germany) focused on a fluidised bed methanation reactor: the Conflux process, described in section 2.1. A pilot plant reactor was built between 1977 and 1981 and later in 1981 a pre-commercial plant was erected, with a production capacity of 2000 m³_{SNG}/h.

There have been other projects about SNG production from coal developing different configurations from fixed and fluidised bed reactor for the methanator. For example, the Synthane project, developed by the Pittsburg Energy Technology Center (USA), the catalytic coal gasification by the Exxon Research and Engineering Company (USA) and the liquid phase methanation proposed by Chem System Inc. (USA). The first and the third project were terminated in 1980-1981.

3.2 Patents

About patents dealing with SNG production process, some are recent and described below, other are older, for instance before 1976 (Müller et al., 1976 and Schultz & Hemsath, 1976).

In the patent by Jahnke & Parab (2007) an invention related to methanation of synthesis gas is reported and, in particular, to a methanation assembly using multiple reactors for controlled methanation. Object of the invention is to produce a gas having a desired

temperature control and methane composition. Also direct water injection is used as a cooling medium to control the temperature in the methanation reactors as well as to avoid deposition of soot on the methanation catalyst.

The process is realized in a methanation assembly for use with a water supply and a gas supply containing gas to be methanated. The reactor assembly has a plurality of methanation reactors each for methanating gas input to the assembly and a gas delivery and cooling assembly adapted to deliver gas from the gas supply to each of the methanation reactors. The system is also to combine water from the water supply with the output of each methanation reactor being conveyed to a next methanation reactor and to carry the mixture to such next methanation reactor.

Three methanation reactors are employed and the gas delivery and cooling assembly includes one or more water injection units, gas dividing units, one or more water routing units and lines connecting these units.

In another recent patent (Ravikumar & Sabbadini, 2007) the invention includes one or more methanation reactors producing a primary methanation product that is cooled to a temperature sufficient to condense water, which is removed in a separator. The dry methanation product is then split to provide a reflux stream to the methanation reactors and a feed stream to an adiabatic trim reactor. The plant comprises at least two methanation reactors that are operated in series, wherein the first reactor receives the recycle steam and the second one a portion of the first methanation reactor effluent and a portion of the first methanation reactor feed. Most preferably a recycle conduit is coupled to the separator and the first primary reactor such that a first portion of the dried effluent is fed to the first primary reactor.

Another patent (Mozaffarian, 2000) reports an invention related to a process for producing methane-rich product gas from biomass or fossil fuels. This patent is focused on the synthesis gas production system, which is a hydrogasification reactor using biomass or fossil fuels as feedstock together with hydrogen from an external source.

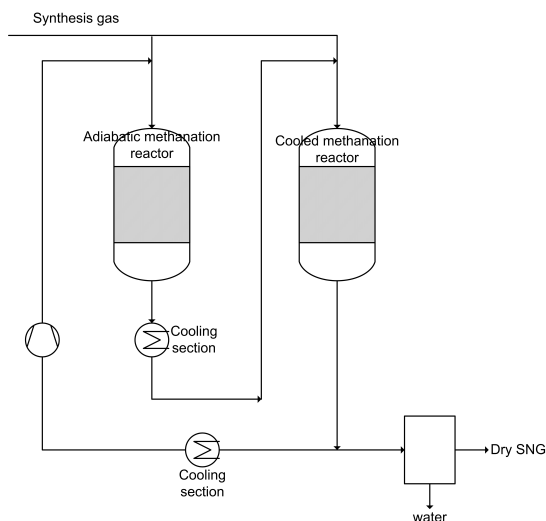

Fig. 6. Simplified Block Flow Diagram of the process patented by Haldor Topsoe A/S, Lyngby, Denmark, adapted from Skov, 1981

A patent, not recent but very interesting, with Haldor Topsoe A/S, Lyngby, Denmark as assignee, is the one by Skov (1981). The scheme of this process is a quite interesting modification of TREMP™ and is reported in Figure 6.

The invention relates to an improved catalytic methanation process, where a feed gas containing predominantly hydrogen and being rich in carbon oxides (CO and/or CO₂) is divided into two part streams of which the first is methanated partially in an adiabatic methanation reactor by a methanation catalyst. After that, the effluent from the adiabatic methanation reactors is mixed, after cooling, with the second feed gas part stream and the thus-combined stream is methanated in a cooled methanation reactor by a catalyst, preferably the same as that used in the adiabatic methanation reactor. It is possible, but not always necessary, to recycle part of the produced gas to the adiabatic methanation reactor to keep the temperature in a moderate level. It is advantageous because it can be operated to produce superheated steam for producing electricity from the cooling sections at the end of the adiabatic reactors. This process has the great advantages that practically all of the heat of reaction can be utilized for producing superheated steam, and that the superheated steam may be produced within the ranges of pressure and temperature which are convenient for the production of electricity. Superheated steam for the production of power has normally a pressure of 90-160 atm and a temperature of 500-550°C.

By the methanation of gases having high content of carbon oxides the amount of heat generated in accordance with the reaction equations 1 and 2 will be so considerable and the temperature so high that the catalyst in an adiabatic reactor may be destroyed, and possibly even the reactor may be damaged (Skov, 1981). One way of solving this problem involves the cooling and recycling a part of the methanated gas from the outlet of the reactor. It is a drawback of this process that considerable amounts of energy is used for the recycling, whereby the total useful effect of the process is reduced.

In summary, this new process consists of these steps:

- dividing the feed gas into two streams, a first feed gas part stream comprising 30-70% by volume of the total feed gas stream and a second feed gas part stream comprising the remainder of the feed gas;
- subjecting the first feed gas part stream to a catalytic methanation in at least one adiabatic methanation reactor containing a bed of catalyst;
- cooling the outlet gas stream from the adiabatic methanation reactor to 250-400°C;
- mixing the cooled outlet stream of the previous step with the second feed gas part stream to form a combined stream;
- subjecting the combined stream from the previous step to a catalytic methanation in at least one cooled methanation reactor containing a bed of catalyst; and finally
- recovering the outlet gas from the cooled methanation reactor totally or partially as a product gas for use or further treatment.

About older patents we quote one by Müller et al. (1976) about the design of the methanator reactor, and a second one (Schultz & Hemsath, 1976) which studies an apparatus and a method for heat removal in a methanation plant.

3.3 Research studies

Among others, Moeller et al. were involved in research projects concerning methanation. They demonstrated the feasibility of methanation of syngas from coal. In a first work (Moeller et al., 1974), tests in a semi-technical pilot plant prove that CO-rich syngas can be

methanated without carbon formation to yield specification grade SNG with a residual hydrogen of less than 1% (vol.) and residual CO less than 0.1% (vol.). Also, it has been demonstrated that trace components left in the synthesis gas after coal gasification and Rectisol wash have little influence on catalyst activity and life. The catalyst used is a special methanation catalyst developed by BASF with a high nickel content supported on Al_2O_3 and activated by reduction with hydrogen. The configuration of the plant consists of two adiabatic methanators. Effluent gas from the first reactor is cooled and a part of this effluent gas is recycled, while the rest is reheated and fed to the final methanation reactor. In fact syngas with an H_2/CO molar ratio equal to 8 are mixed with recycle gas and then the total feed is heated and sent to the first methanation reactor with addition of steam (as inert agent). Effluent gas from the first reactor is cooled, condensing the steam. Part of the reactor effluent gas is recycled, while the rest is reheated and fed to the final methanation reactor. At the inlet of the first reactor methane content is about 51.6% vol. whereas at the exit is 55.6% vol. At the exit of the second methanator the methane content is about 75.1% vol. and the rest is mainly carbon dioxide (21.1% vol.) and inerts, i.e. N_2 and Ar (2.0% vol.) (Moeller et al., 1974).

Tucci and Thomson (Tucci & Thomson, 1979) carried out a comparative study of methanation over ruthenium catalyst both in pellet and in honeycomb form. In addition to pressure drops lower by two orders of magnitude they found also significantly higher selectivities (97% versus 83%) over the monolith catalyst.

Recent studies on SNG production have been performed by Duret et al. (Duret et al., 2005), by Zwart and Boerrigter (Zwart & Boerrigter, 2005), by Waldner and Vogel (Waldner & Vogel, 2005) and more recently by Sudiro et al. (Sudiro et al., 2009), Juraščík et al. (Juraščík et al., 2009) and Gassner and Maréchal (Gassner & Maréchal, 2009).

Objective of the work of Duret et al. (Duret et al., 2005) was to perform a study of the process in order to find its optimal operating parameters. The methodology used combines process modelling and process integration techniques. It passes through two steps: a thermodynamic model of the process and a process integration to identify the energy saving opportunities. The process design of a 10-20 MWth Synthetic Natural Gas (SNG) production process from wood has been performed.

Methanation reactor is based on the Comflux® process, in which the reactor is a pressurized fluidized bed reactor with an internal cooling system which allows performing an isothermal once through methanation of coal gas. Note that methanation reactor has been modelled by using a simplified model (thermodynamic equilibrium, pressure of 60 bar and outlet temperature of 400°C) without considering heat transfer problem.

This work demonstrated that the process can transform wood into pipeline quality methane with a thermal efficiency of 57.9% based on the Lower Heating Value (LHV). The process integration study shows that the heat surplus of the process can be used to almost satisfy the mechanical work required by the process; only 7% of the mechanical needs should come from an external source, for example by converting the excess of heat produced in the system.

Objective of the study of Zwart and Boerrigter (Zwart & Boerrigter, 2005) was to determine the technical and economic feasibility of large-scale systems for the co-generation of "green" Fischer-Tropsch (FT) transportation fuels and "green" SNG from biomass. The systems were assessed assuming a targeted annual production of 50 PJ (1 PJ = 10^{15} J) of FT transportation fuels and 150 PJ of SNG. The evaluated overall system is composed of the entire chain of

biomass collection, transport, syngas production via gasification, gas cleaning, and FT and SNG synthesis. In case of co-production, some of the thermal biomass input is converted to liquid fuels by FT synthesis and the off-gas is methanated to produce SNG. In the integrated co-production concepts, some of the product gas is used for FT synthesis and the other portion is used for SNG synthesis, whereas in the parallel co-production concepts, two different gasification processes are used.

For all the systems evaluated, an Aspen Plus™ model was constructed, to determine the mass, heat, and work balances of the processes. Six combinations of gasifier type, operating pressures, and pressurization gas were considered.

The major conclusions, with respect to the technical feasibility of producing synthetic natural gas (SNG) as co-product of FT liquids are (Zwart & Boerrigter, 2005):

- there is no incentive to produce either SNG or FT liquids, because the conversion efficiencies to both products are essentially equal;
- the overall efficiencies (FT liquids plus SNG) are higher for circulating fluidized bed and indirect gasification concepts, compared to gasification with oxygen, because a significant amount of CH₄ and C₂ compounds is already present in the product gas;
- additional SNG can be produced either by “integrated co-production”, in which a side-stream of the product gas of the gasifier is used for dedicated methanation, or by “parallel co-production”, in which some of the biomass is fed to a second gasifier that is coupled to a dedicated stand-alone methanation reactor.

Another research work is that by Waldner and Vogel (Waldner & Vogel, 2005). Here, the production of SNG from wood by a catalytic hydrothermal process was studied in a laboratory batch reactor suitable for high feed concentrations (10-30 wt %) at 300-410°C and 12-34 MPa with Raney nickel as the catalyst. A maximum methane yield of 0.33 (g of CH₄)/(g of wood) was obtained, corresponding to the thermodynamic equilibrium yield.

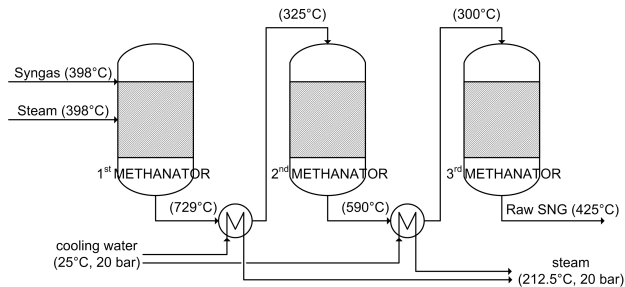

Fig. 7. Scheme of the ICI methanation process, adapted from Juraščík et al., 2009

Another recent work by Juraščík (Juraščík et al., 2009) performed a detailed exergy analysis for the SNG process based on woody biomass gasification: an overall energy efficiency of 72.6% was found. To simulate the methane synthesis the steam-moderated ICI high-temperature once-through methanation process was chosen. This process, which is shown in Figure 7, consists of three methanation reactors and two heat exchangers placed between them in order to control the temperature of gas entering the 2nd and 3rd methanation reactor. The indicated temperatures of the streams entering and leaving the reactors are the original temperatures of the ICI technology.

Gassner and Maréchal (Gassner & Maréchal, 2009) developed a detailed thermo-economic model considering different technological alternatives for thermochemical production of SNG from lignocellulosic biomass (wood) investigating the energetic performances of the processes. Gasification and methanation reactors have been represented by using simplified models (i.e. thermodynamic equilibrium ones) which is a reasonable assumption for methanation when the amount of catalytic material is suitable, as in this case product's composition obtained is very similar to that at equilibrium (Duret et al., 2005). In the work by (Gassner & Maréchal, 2009) there is no particular attention to methanation reactor but authors report only that common industrial installations use product gas recycle loops or multiple intercooled reactors with prior steam addition to obtain a suitable temperature control. The model they proposed is based on data from existing plants and pilot installations; it was shown that the conversion of woody biomass to SNG is a viable option with respect to both energetic and economic aspects, and the overall energy efficiency of the process is in the range 69-76%.

Sudiro et al. (Sudiro et al., 2009) developed and simulated a process to produce SNG from petcoke via gasification, facing the main issue of this process: the temperature control of the methanator. For the methanation section the problem of temperature control has been resolved with a proper suitable use of recycle streams. The process consists in three main sections: petcoke gasification, syngas purification system and methanation reactor. The attention is focused on the syngas generation, obtained with a dual bed petcoke gasification system, and the methanation reactor. For the first section a detailed model including kinetics and mass transfer was investigated, for the methanation section three different possible configurations (A, B, and C) of the plant was developed. Figure 8 shows configuration A, where cooled and purified syngas is sent to methanation, after being split into three streams: the first one is sent to the first methanator together with part of the outlet stream from this reactor, which is recycled by a compressor. The part not recycled is sent to a second methanator with fresh syngas and then, in a similar way, the outlet from this second reactor is sent to the third methanator with part of the fresh syngas. The outlet from the third methanation reactor is sent to a cooling section, then to a unit to remove carbon dioxide, and finally the gas is dried and the SNG product is recovered.

The system has two main disadvantages. Firstly, it requires many Acid Gas Removal (AGR) units: one unit at the output of gasifier in order to remove CO₂ but especially H₂S, which is a poison for the methanation catalyst, a second one at the output of shift reactor and a final one to separate the product, i.e. SNG, from carbon dioxide. The second disadvantage is the use of a compressor, which complicates the plant, and represents a relevant additional energy consumption.

Performances of the global process to produce SNG from petcoke were simulated with Aspen Plus™ and evaluated with respect to product yield, CO₂ emissions and overall energy efficiency. They are shown in Table 1. The value of product yield was found to be 39.7%, CO₂ emissions amount to 2.2 kg per kg of SNG produced and the overall energy efficiency is 67.7%, similar to that of a conventional Gas-to-Liquid (GTL) process (Sudiro & Bertucco, 2007).

The second configuration (B) proposed is similar to the first one with the difference that the water condensed and recovered from the product (SNG), after being pumped, is partly sent to the second methanator, and partly to the third methanator, while another portion is purged out of the system. In this way the inert content in the stream sent to reactors is

works without the use of the compressor, thereby reducing both the plant complexity and the operating costs.

4. Coal-to-SNG projects in the world

The only commercial-scale coal-to-SNG plant is located in Beulah, North Dakota USA, owned by Dakota Gasification company. This plant began operating in 1984 and uses 6 million tons of coal per year with an average yearly production of approximately 54 billion standard cubic feet (scf). Synthetic natural gas leaves the plant through a 2-foot-diameter pipeline, travelling 34 miles south.

In addition to natural gas, this synfuel plant produces fertilizers, solvents, phenol, carbon dioxide and other chemicals. Carbon dioxide is now part of an international venture for enhanced oil recovery in Canada (www.dakotagas.com).

The plant had a cost of \$2.1 billion and a work force of more than 700 people (www.gasification.org/Docs/Conferences/2007/45FAGE.pdf).

The heart of the Dakota plant is a building containing 14 gasifier, which are cylindrical pressure vessels 40 feet high with an inside diameter of 13 feet. Each day 16000 tons of lignite are fed into the top of the gasifiers. Steam and oxygen are fed into the bottom of the coal beds causing intense combustion (2200°F (~1094°C)). Ash is discharged from the bottom of the gasifiers. The raw gas goes to the gas cooling area where the tar, oils, phenols, ammonia and water are condensed from the gas stream. These byproducts are sent on for purification and transportation. Other byproducts are stored for later use as boiler fuel for steam generation. The gas is moved to a cleaning area where further impurities are removed. Methanation is the next step, which takes place by passing the cleaned gas over a nickel catalyst causing carbon monoxide and most remaining carbon dioxide to react with free hydrogen to form methane. Final cleanup removes traces of carbon monoxide. The gas is then cooled, dried and compressed and enters the pipeline (www.dakotagas.com).

Today in the United States many SNG plants are planned and some of them are expected to be operational in the decade 2010-2020 (Petrucci, 2009). Table 2 reports coal-to-SNG projects in the United States.

Coal-to-SNG plants are becoming the new focus in China's coal chemical industry. Currently there are about 15 coal-to-SNG projects proposed in China. It is expected that China will have around 20 billion Nm³/a SNG capacity in 2015 (www.chemconsulting.com.cn/info_detail01.asp?id=7677). Shenhua Group has different projects for SNG plant in China: in Yijinhuoluo County, Ordos City and Inner Mongolia (Petrucci, 2009).

For biomass, the only commercial project is in Sweden. In the Gothenburg Biomass Gasification Project (GoBiGas), started in 2008, SNG will be produced from forest residues. A 20 MW_{SNG} plant is scheduled to be commissioned in 2012 and a further 80 MW_{SNG} plant is scheduled to be in operation by 2016 (Kopyscinski et al., 2010). These plants will use PSI technology for methanation process and the FICFB gasifier similar of that of Güssing.

Project Owner	Project Name	Location	Feedstock	Status	SNG Capacity
Secure Energy Systems, Siemens SFG	Secure Energy Systems SNG	Decatur, Illinois	Bituminous coal	Commissioning 2010	20 Billion scf/yr
Peabody Energy, Conoco-Phillips	Kentucky NewGas Energy Center	Central City, Kentucky	Coal	Planning-Development	60-70 Billion scf/yr
TransGas Development Systems	Scriba Coal Gasification Plant	Scriba, New York	Coal	Fully operational in late 2010	-
Great Northern power Development/ Allied Syngas	South Heart Gasification Project	South Heart, North Dakota	Lignite	Construction to begin 2010. To be complete in 2012	100 Million scf/day
Lackawanna Clean Energy	Lackawanna Clean Energy	Lackawanna, NY	Petcoke	In operation by 2012	85 Million scf/day
C Change Investments, NC12	-	Louisiana	Coal-Petcoke	Commissioning 2012 (estimated)	300 Billion scf/yr
Cash Creek Generation LLC	-	Henderson County, Kentucky	Coal	Construction to be completed in 2012	720 MW natural gas combined-cycle power plant
Indiana Gasification LLC	-	Spencer County, Illinois	Coal	Expected to be operational in late 2012 or 2013	-
Christian County Generation, LLC	Taylorville Energy Center (TEC)	Taylorville, Illinois	Bituminous Coal	Construction to begin in 2010. Commercial operation in 2014.	500 MW IGCC and SNG production
Hunton Energy (US)	Freeport plant (HE)	Freeport (Texas)	Petcoke-coal-biomass	Completion in 2015	180 Million scf/day
Power Holdings, LLC	Southern Illinois Coal-to-SNG	Jefferson County, Illinois	Coal	Planning	65 Billion scf/yr

Table 2. USA Coal-to-SNG projects (Petrucci, 2009)

5. Research and recent developments about SNG processes from coal and biomass

The technical assessment of different technological systems for SNG production is currently an important research topic. Some new ideas are briefly reviewed in the following. Three processes have been recently developed in the USA (Kopyscinski et al., 2010):

1. Bluegas™ process by Great Point Energy;
2. fluid-bed methanation process by Research Triangle Institute (RTI);
3. hydro-gasification process by Arizona Public Service (APS).

The first one is proposed by Great Point Energy and is a hydro-methanation process, called Bluegas™, where gasification and methanation reactions occur in the same catalytic reactor working at temperatures between 600 and 700°C. The Bluegas™ gasification system is an optimized catalytic process for combining coal, steam and a catalyst in a pressurized reactor vessel to produce pipeline-grade methane (about 99% CH₄) instead of the low quality syngas obtained by conventional coal gasification. This technology employs a novel catalyst to “crack” the carbon bonds and transforms coal into clean burning methane (www.greatpoint). The first step is to feed the coal or biomass and the catalyst into the methanation reactor. Inside the reactor, pressurized steam is injected to “fluidize” the mixture and ensure constant contact between the catalyst and the carbon particles. In this environment, unlike the conventional gasification, the catalysts facilitates multiple chemical reactions between the carbon and the steam on the surface of the coal (or biomass).



The overall reaction is the following:



Accordingly, in a single reactor a mixture predominantly composed of a mixture of methane and CO₂ is generated.

The proprietary catalyst formulation is made up of abundant, low cost metal materials specifically designed to promote gasification at the low temperatures where water gas shift and methanation take place. The catalyst is continuously recycled and reused within the process. Unlike many conventional gasifiers, the Bluegas™ process is ideally suited for lowest cost feedstocks such as petroleum coke from the Canadian oil sands (a waste product produced in the upgrading process) as well as a number of biomass feedstocks. The result is a technology with improved economics and an environmental footprint equivalent to that of natural gas, the most environmentally-friendly fossil fuel.

The Bluegas™ technology has several advantages:

- it produces methane in a single step and in a single reactor, called catalytic coal methanation (with no need for external water gas shift reactor and for external methanation reactor);

- it produces CO₂ as a valuable sequestration-ready byproduct;
- it significantly reduces operating temperatures so there are lower costs for reactor components, lower maintenance costs. Costs for high temperature cooling are eliminated;
- costs for air separation plant are eliminated because it utilizes steam methanation;
- it has an high efficiency (65% of overall efficiency).

The catalyst is able to “crack” the carbon bonds and transforms coal into clean burning methane (Lesemann, 2004). Tests on a pilot plant in Illinois has been done for more than 1200h but no data are available (Kopyscinski et al., 2010).

As a second process, we quote the one by the Research Triangle Institute (RTI), which has developed a system for producing SNG and electric power from coal. Coal is sent to a pyrolyzer where products are char and a gaseous mixture; char is used to generate electricity and the gas is sent to a methanation fluidized-bed reactor in order to produce a syngas rich in methane. About this process no experimental data are available. At this time RTI has a fluid-bed methanation bench scale system (Lesemann, 2004). Also Peabody Energy and GasPoint Energy are working towards this project (www.trib.com/news/state-and-regional/article_03676d79-d722-525e-98d9-946be031fcd2.html).

Finally, Arizona Public Service (APS) are developing a hydro-gasification process where coal is gasified with hydrogen at moderate temperatures (870°C) and high pressures (70 bar). Methane is directly produced in the gasifier without using a catalyst. In this process electric power is produced by burning the unconverted char, and a part of the SNG obtained must be use to generate the hydrogen required for hydro-gasification.

Among other projects in progress we are studying an innovative solution where the problem of temperature control, typical of fixed-bed methanation reactors, can be overcome by using monolith catalyst supports (Sudiro et al., 2010). The use of monolith catalyst supports offers at least two advantages with respect to conventional packed-bed reactors: pressure drops are greatly reduced (to less than 1%) and the radial heat transport can be more favorable.

The possibility of using monolithic reactors carrying out exothermic methanation reactions from syngas was investigated by process simulation. The reactor is an externally cooled fixed-bed reactor, loaded with honeycomb catalysts. It was shown that synthetic natural gas can be produced in a single pass monolithic catalyst reactor, with acceptable CO conversion values (around 80%) and temperature hot spots compatible with the catalyst stability. This system improves the presently adopted process configurations (Sudiro et al., 2009), as it overcomes the problem of temperature control typical of fixed-bed methanation reactors. The use of monolith reactors is also useful in view of process intensification: we have verified that the GHSV can be increased up to 20000 h⁻¹, with minimal pressure drops, increasing the cooling temperature correspondingly (Sudiro et al., 2010).

For what concerns SNG from biomass a number of centers in Europe are addressing this problem (Kopyscinski et al., 2010).

For example the Energy Research Centre of the Netherlands (ECN) began in 2002 a preliminary study to investigate the feasibility of SNG production from biomass (wood, sewage sludge and lignite) via indirectly heated gasification (MILENA) (www.ecn.nl). In 2003 ECN used a fixed bed catalytic reactor where tests about methanation reactions from gas produced by a wood gasifier were carried out for about 150h. The ongoing activity focuses on the construction of an 800 kWth pilot plant.

In Germany the Center for Solar Energy and Hydrogen Research (ZSW) has developed the Absorption Enhanced Gasification/Reforming (AER) process where a gas rich in H₂ is produced from biomass in a dual fluidized bed and recent activities are about the production of SNG from this gas in a molten salt cooled multi-tubular reactor. Preliminary results about these tests are available.

Finally, at the Paul Scherrer Institute (PSI) in Switzerland a research about the conversion of dry biomass to SNG has been carried out for about ten years. This project started from an idea promoted by Gazobois SA since the early 1990s. PSI started this project in 1999 and at the end of 2002 a preliminary study was successfully finished, in which theoretical and experimental investigations about gasification and methanation technologies were done. The Fast Internally Circulating Fluidized Bed (FICFB) gasification process was selected as a gasification technology, so that a plant was built in Güssing (Austria); for methanation the selected technology was the Comflux® fluidized bed process. A bench scale reactor was designed and connected to the FICFB gasifier in Güssing in 2003 and tested for 120h; in addition, before the end of 2004 a 10 kW_{SNG} reactor (in term of chemical energy content of the SNG) was designed and built at PSI. Different tests were performed until 2007; after that, based on the results obtained, a 1 MW_{SNG} Process Development Unit (PDU) has been erected with the aim to demonstrate the complete process chain from wood to SNG including gasification, gas cleaning, methanation and gas purification in a semi commercial scale. In December 2008 the FICFB produced gas was converted to methane rich gas in the PDU and in June 2009 the PDU was operated during 250h at up to 1 MW_{SNG}, producing 100 m³/h of high quality synthetic natural gas.

At the Paul Scherrer Institute, a process converting microalgae to a methane-rich gas is under study (Haiduc et al., 2009). This new technology, called SunCHem, produces bio-methane via hydrothermal catalytic gasification of microalgae, where nutrients, water and the CO₂ produced are recycled. The two main parts of this process: growing of microalgae and hydrothermal gasification biomass, have been previously studied independently; in this work the fact of coupling these two parts into a sustainable process is a novel concept. The experimental work at PSI is, for example, about the investigation of the supercritical catalytic gasification of different species of microalgae (for example *Phaeodactylum tricornerutum* and *Spirulina platensis*), and about the influence on the growth of algae of nickel, which is a trace contaminant that may be present in the effluent recycled from the gasification-methanation step.

A simplified scheme of this process is presented in Figure 9. The process consists of five steps. In the first one biomass is produced in a photobioreactor, after the excess water is removed mechanically from the biomass to approx. 15–20% wt. dry mass. The separated water, which contains a part of the nutrients, is recycled to the algae growth system. As a third step, the biomass slurry is liquefied hydrothermally by heating it up to a temperature of 400–450°C at 30 MPa, and the remaining nutrients are separated from the liquefied slurry for reuse as nutrients. The stream containing the organic fraction and the water is catalytically gasified under hydrothermal conditions to methane by using a catalyst such as ruthenium or nickel. Finally, CO₂ is separated from the product gas and recycled to the photobioreactor.

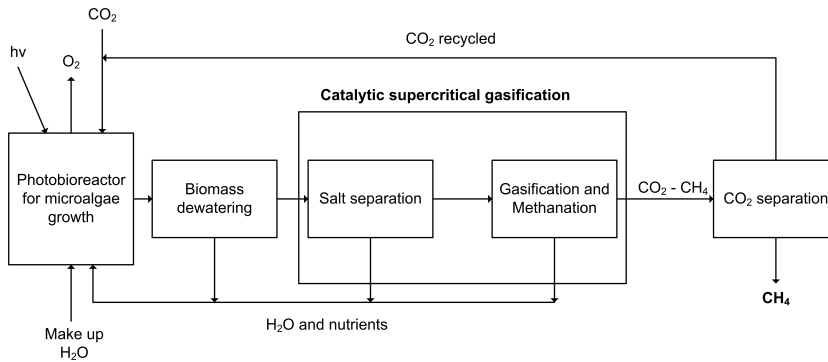

Fig. 9. Simplified scheme of Sun CHem process for the production of methane using microalgae, adapted from Haiduc et al., 2009

With regard to conventional gasification, which requires a dry biomass feed (moisture content lower than 15%), the hydrothermal process is suitable to convert/gasify wet biomass (moisture higher than 60%) into a fuel gas with a high heating value. This process operates under pressure, but at temperatures much lower (ca. 400°C) than typical gasification temperatures (800–900°C).

Also, in another work (Stucky et al., 2009) experimental tests showed that catalytic hydrothermal gasification of microalgae (in this particular case *Spirulina platensis*) can be a viable option for sustainable production of fuel with carbon capture.

6. Conclusions and Outlook

SNG production from coal or biomass is currently under strong investigation due to rising prices of natural gas and the wish for less dependency from natural gas imports. The interest is high especially in USA and China. So, the technical assessment of different technological alternatives for SNG production is an important research topic, even though, at present, only one industrial plant is in operation (North Dakota gasification plant).

Starting from the 1970s, as a consequence of the energy crisis, a number of methanation processes were developed comprising both fixed beds and fluidised beds. The large amount of heat of reaction in fixed bed reactors is usually removed by a combination of gas recycle cooling and steam adding, resulting in a high number of reactors, heat exchangers and compressors. Nowadays many projects are in progress especially for the conversion of wood biomass and wet biomass (microalgae) into SNG. At the ECN in the Netherlands there is a 800 kW_{th} pilot plant for studying the production of methane from wood, sewage sludge and lignite. At the Paul Scherrer Institute (PSI) in Switzerland a research about the conversion of dry biomass to SNG has been carried out for about ten years with the construction in June 2009 of a semi commercial plant (1 MW_{SNG}) including gasification, gas cleaning, methanation and gas purification, producing 100 m³/h of high quality synthetic natural gas. At PSI also an innovative technology is under investigation: the Sun CHem process for the production of methane using microalgae via catalytic supercritical gasification. Also in our research group different process configurations for methane synthesis plant from syngas

were developed to overcome the problem of temperature control typical of fixed-bed methanation; the best scheme proposed consists in the use of a monolithic reactor with the advantage of avoiding the recycle and reducing at minimum the numbers of reactors required to convert all the carbon monoxide in the feed.

7. References

- Duret, A.; Friedli C. & Maréchal, F. (2005). Process design of synthetic natural gas (SNG) production using wood gasification. *Journal of Cleaner Production*, 13, 1434-1446.
- Gassner, M. & Maréchal, F. (2009). Thermo-economic process model fro thermochemical production of Synthetic Natural Gas (SNG) from lignocellulosic biomass. *Biomass & Bioenergy*, 33, 1587-1604.
- Haiduc, A.G.; Brandenberger, M.; Suquet., S; Vogel, F.; Bernier-Latmani, R. & Ludwig, C. (2009). SunChem: an integrated process for the hydrothermal production of methane from microalgae and CO₂ mitigation. *Journal of Applied Phycology*, 21, 529-541.
- Jahnke, F. C. & Parab, S. C. (2007). Methanation Assembly using Multiple Reactors. U.S. Patent 7247281 B2 (Jul. 24, 2007). Assignee: FuelCell Energy, Inc., Danbury, CT (US).
- Juraščík, M.; Sues, A. & Ptasinski, K.J. (2009). Exergetic evaluation and improvement of biomass-to-synthetic natural gas conversion. *Energy & Environmental Science*, 2, 791-801.
- Kopyscinski, J.; Schildhauer, T.J. & Biollaz, S.M.A. (2010). Production of synthetic natural gas (SNG) from coal and dry biomass – A technology review from 1950 to 2009. *Fuel*, in Press.
- Lesemann, M. (2004). An overview of energy and power generation RD&D at RTI International. Available at the website:
https://www.rtec.rtp.org/Userfiles/File/Presentations_Nov14-Nov16/04-RTEC_Lesemann.pdf
- Moeller, F. W.; Roberts, H. & Britz, B. (1974). Methanation of coal gas for SNG. *Hydrocarbon Processing*, 53, 69-74.
- Mozaffarian, M. (2000). Process for Converting Hydrogen into Substitute Natural Gas. World Intellectual Property Organization, International Publication Number WO 00/21911 (Apr. 20, 2000).
- Müller, W.; Möller, F.W. & Pirl, K. (1976). Methanation Reactor. U.S. Patent 3996014 (Dec. 7, 1976). Assignee: Metallgesellschaft Aktiengesellschaft, Frankfurt am Maim, Germany.
- Petrucci, D. (2009). Summary of activities: Coal-to-SNG and Coal-to-Chemicals, US Department of Energy - Office of Sequestration, Hydrogen, and Clean Coal Fuels. Available at the website:
http://www.energy.psu.edu/osd/reports/DPetrucci_2009.pdf
- Ravikumar, R. & Sabbadini, G. (2007). Configurations and Methods of SNG Production. World Intellectual Property Organization, International Publication Number WO 2007/117587 A2 (Oct. 18, 2007).
- Schultz, T. J. & Hemsath, K. H. (1976). Apparatus and Method for Methanation. U.S. Patent 3970435 (Jul. 20, 1976). Assignee: Midland-Ross Corporation, Cleveland, Ohio.

- Stucky, S; Vogel, F.; Ludwig, C; Haiduc, A.G. & Brandenberger, M. (2009). Catalytic gasification of algae in supercritical water for biofuel production and carbon capture. *Energy & Environmental Science*, 2, 535-541.
- Sudiro, M. & Bertucco, A. (2007). Synthetic fuels by a limited CO₂ emissions process which uses both fossil and solar energy. *Energy & Fuels*, 21, 3668-3675.
- Sudiro, M.; Zanella, C.; Bressan, L.; Fontana, M. & Bertucco, A. Synthetic natural gas (SNG) from petcoke: model development and simulation. *Proceedings of ICheaP-9, The ninth International Conference on Chemical & Process Engineering*, pp. 1251-1256, Rome-Italy, May 10-13, 2009.
- Sudiro, M.; Bertucco, A.; Groppi, G. & Tronconi, E. Simulation of a structured catalytic reactor for exothermic methanation reactions producing synthetic natural gas. *Proceedings of the 20th European Symposium on Computer Aided Process Engineering - ESCAPE20*, pp. 691-696, Ischia-Italy, June 6-9, 2010.
- Skov, A. (1981). Process and a Plant for Preparing a Gas Rich in Methane. U.S. Patent 4298694 (Nov. 3, 1981). Assignee: Haldor Topsoe A/S, Lyngby, Denmark.
- Topsoe, H. (2009). From Coal to Substitute Natural Gas using Tremp™. Available at the website: www.topsoe.com
- Tucci, E.R. & Thomson, W.J. (1979). Monolith catalyst favoured for methanation. *Hydrocarbon Processing*, 58, 123-126.
- Ullmann's Encyclopedia of Industrial Chemistry*, 5th completely revised edition (1989). VHC Verlagsgesellschaft mbH, D-6940 Weinheim, Federal Republic of Germany.
- Waldner, M. H. & Vogel, F. (2005). Renewable Production of Methane from Woody Biomass by Catalytic Hydrothermal Gasification. *Industrial & Engineering Chemistry Research*, 44, 4543-4551.
- Zwart, R. W. R. & Boerritger, H. (2005). High efficiency co-production of synthetic natural gas (SNG) and Fischer-Tropsch (FT) transportation fuels from biomass. *Energy & Fuels*, 19, 591-597.

Web sites:

http://www.chemconsulting.com.cn/info_detail01.asp?id=7677

<http://www.dakotagas.com>

<http://www.greatpointenergy.com>

http://www.trib.com/news/state-and-regional/article_03676d79-d722-525e-98d9-946be031fcd2.html 318359

<http://www.syngasrefiner.com/SNG/agenda.asp>

<http://www.zeuslibrary.com>

<http://www.gasification.org/Docs/Conferences/2007/45FAGE.pdf>

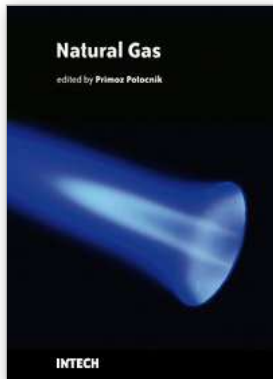

Natural Gas

Edited by Primož Potočnik

ISBN 978-953-307-112-1

Hard cover, 606 pages

Publisher Sciyo

Published online 18, August, 2010

Published in print edition August, 2010

The contributions in this book present an overview of cutting edge research on natural gas which is a vital component of world's supply of energy. Natural gas is a combustible mixture of hydrocarbon gases, primarily methane but also heavier gaseous hydrocarbons such as ethane, propane and butane. Unlike other fossil fuels, natural gas is clean burning and emits lower levels of potentially harmful by-products into the air. Therefore, it is considered as one of the cleanest, safest, and most useful of all energy sources applied in variety of residential, commercial and industrial fields. The book is organized in 25 chapters that cover various aspects of natural gas research: technology, applications, forecasting, numerical simulations, transport and risk assessment.

How to reference

In order to correctly reference this scholarly work, feel free to copy and paste the following:

Maria Sudiro and Alberto Bertucco (2010). Synthetic Natural Gas (SNG) from Coal and Biomass: a Survey of Existing Process Technologies, Open Issues and Perspectives, Natural Gas, Primož Potočnik (Ed.), ISBN: 978-953-307-112-1, InTech, Available from: <http://www.intechopen.com/books/natural-gas/synthetic-natural-gas-sng-from-coal-and-biomass-a-survey-of-existing-process-technologies-open-issue>

INTECH
open science | open minds

InTech Europe

University Campus STeP Ri
Slavka Krautzeka 83/A
51000 Rijeka, Croatia
Phone: +385 (51) 770 447
Fax: +385 (51) 686 166
www.intechopen.com

InTech China

Unit 405, Office Block, Hotel Equatorial Shanghai
No.65, Yan An Road (West), Shanghai, 200040, China
中国上海市延安西路65号上海国际贵都大饭店办公楼405单元
Phone: +86-21-62489820
Fax: +86-21-62489821

© 2010 The Author(s). Licensee IntechOpen. This chapter is distributed under the terms of the [Creative Commons Attribution-NonCommercial-ShareAlike-3.0 License](#), which permits use, distribution and reproduction for non-commercial purposes, provided the original is properly cited and derivative works building on this content are distributed under the same license.