

# Neural Fuzzy Based Indoor Localization by Extending Kalman Filtering with Propagation Channel Modeling

Bing-Fei Wu, Cheng-Lung Jen and Kuei-Chung Chang  
*National Chiao Tung University  
Taiwan*

## 1. Introduction

In this chapter, an indoor localization based on the Received Signal Strength Indication (RSSI) from the Wireless Local Area Network (WLAN) and the Adaptive Neural Fuzzy Inference system (ANFIS) is proposed. Over the last few years, the wireless local area networks based on IEEE802.11b (also named WiFi) and location-based service have been flourishing and increased demand. The wireless networks have become a critical part of the networking infrastructure, and capable for mobile devices equipped with the WLAN to receive the radio signal for networking. Location-aware computing is a recent interesting research issue that exploits the possibilities of modern communication technology due to the location-based service which has a great potential in areas such as library or museum tour-guide, free mobility and nursing at home, patient transporting in the hospital and easy going capability in the shopping mall.

The location of a mobile terminal can be estimated by using the strength of the radio signal with the WLAN. However, the unpredictability of signal propagation through indoor environments is the key challenge in the indoor positioning from the strength of the WLAN signals. It is difficult to provide an adequate likelihood model of signal strength measurements. Thus, the main focus of research in this area have been on the development of the technique that can generate the accurate empirical model from the training data collected in the test area and the real-time recursive estimation for the mobile user.

There are many important propagation models based on the localization techniques. (Bahl & Padmanabhan, 2000; Wassi et al., 2005; Li, B.; Salter & Dempster, 2006) addressed the range based approach, such as pattern matching that relies on the range measurement to compute the position of the unknown node. (Kotani et al., 2003) offered the design and implementation of a Bluetooth Local Positioning Application (BLPA). First, they converted the received signal power to the distance, according to a theoretical radio propagation model, and then, the Extended Kalman Filter (EKF) is used to compute 3-D position with the basis of distance estimates.

(Ito & Kawaguchi, 2005) introduced a Bayesian frame work for indoor positioning over the IEEE 802.11 infrastructure, which investigated the direction and distribution of the signal strength for the pre-observation model, and then a location of the mobile device can be computed by using the Bayesian filtering (Fox et al., 2003). (Seshadri, 2005) provided a

Source: Kalman Filter, Book edited by: Vedran Kordić,  
ISBN 978-953-307-094-0, pp. 390, May 2010, INTECH, Croatia, downloaded from SCIYO.COM

probabilistic approach based indoor localization that uses the received signal strength indication as only sensor reading in the Wireless Sensor Networks (WSN), the estimation of location and orientation are computed by a Bayesian filter on the sample set derived using Monte-Carlo sampling. Subject to the power map obtained through the field measurements (Morwilli et al., 2006), the position of a moving user can be estimated and tracked by using the particle filtering that implemented an irregular sampling of a posterior probability space for lower computational power required.

An artificial neural network based work with the supervised learning strategy to reduce the localization error caused by the interference, reflection and other unexpected interruption is presented in (Battiti et al., 2002; Ocana et al., 2005; Ahmad et al., 2006; Ivan & Branka, 2005). During the offline phase, RSSI and the corresponding location coordinates are adopted as the inputs and the targets for the training purpose. The input vector of signal strengths is multiplied by the trained input weight matrix. Thus the location of a mobile device is directly obtained by the outputs of the trained neural network without the detailed knowledge of the access point locations and the specific building characteristics. An indoor localization according to the Maximum Likelihood (ML) algorithm is applied to the measured reference radio map of RSSI (Hatami, 2006), and then an empirical radio map generated from propagation model is compared with the performance of the nearest neighbor method and ML location estimation. (Teuber et al., 2006) proposed a two-stage fuzzy inference system to determine the locations on the basis of Signal-to-Noise Ratio (SNR) in the WLAN measurements and Euclidean distance fingerprints.

In this research, a comprehensive study of the wireless indoor localization based on the three kinds of the propagation channel modeling is addressed. Due to the unpredictability of radio propagation such as the interference, reflection and multipath effects, the adaptive neural fuzzy inference system based on the supervised self-learning strategy is proposed to adapt the indoor environment and reduce the erroneous mapping of the physical distances from RSSI values. In addition, an alternative approach such as interpolation is offered to extend the capability of the propagation model for the small, median and large scale environment, which provides the possibility and the flexibility for the adaption of the indoor positioning. The presented techniques can be developed without any hardware factors of the access point and the knowledge of the test environment. Furthermore, a curve fitting based method is used to compare with the ANFIS and the interpolation. Finally, the extended Kalman filtering is used to perform the location estimation of the mobile terminal in the real indoor environment with 4 access points only.

This chapter is organized as follows. Section 2 introduces the problem formulation for the WLAN indoor positioning and an overview of the proposed approach. Section 3 develops three kinds of the radio wave propagation channel models based on the curve fitting, interpolation and neural fuzzy based approach, respectively. Section 4 presents a position estimation computed by using the extended Kalman filtering with the basis of the distance estimates. Section 5 provides a description of the experimental evaluation of the proposed indoor positioning techniques and reports the results. Conclusion and the future work are given in Section 6.

## 2. Problem formulation

The accuracy and coverage provided by Global Positioning Systems (GPS) or cellular systems are limited in indoor environments. The WLAN standard IEEE 802.11, operating in

the 2.4GHz Industrial, Scientific and Medical (ISM) band, has become a critical part of a public space. Since the wireless information access based on the IEEE 802.11 is now widely available, there is a high demand for accurate positioning in wireless networks, including indoor and outdoor environments. The WLAN positioning is favored because of its cost effectiveness and terminal-based service, while the sensing and positioning are performed on mobile devices. In this study, the WLAN signal strength is used to estimate the corresponding physical distances between the access point and terminal device, and then, a location inference technique based on Kalman filtering is proposed for determining the 2-D location of a mobile device user.

The indoor environment shown in Fig. 1 consists of one corridor, five classrooms and one bathroom with many walls is utilized to demonstrate the proposed wireless indoor localization scheme. The dimension of the experimentation area is 20.6 meters by 37.4 meters with only 4 APs. Each of the access points provides only partial coverage of the environment. These four access points were mounted on the wall with a height 2.7 meters in the classroom, and the localized mobile device was placed at the height 1.2meter. It is clear that the structure of the test environment is not an ideal free space while there were many unpredictable factors such as the propagation interference, reflection, multipath effects, obstacles, radio noise and clustered pedestrian in this area at the same time.

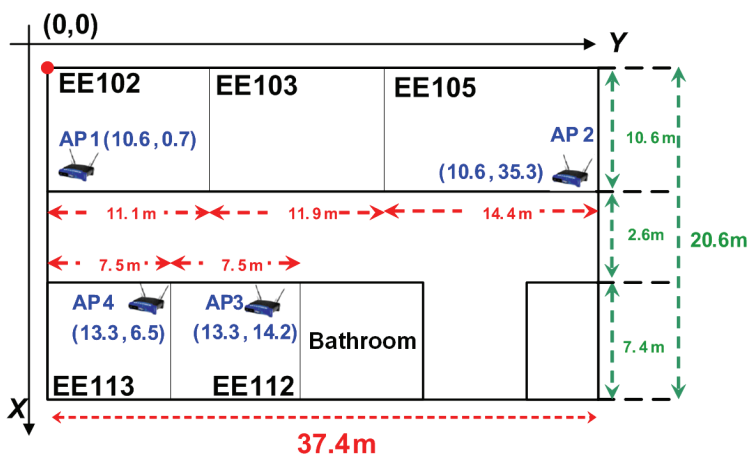

Fig. 1. Map of the experimentation area.

To investigate the characteristics of the WLAN signal propagation, the access points are scanned and the received signal strength indication values are collected. The received signal strength (in the unit of dBm) and noise were obtained by the WLAN adapters in the interval of 2.5 meters, up to about 40 meters. The WLAN client gathered the received signal strength indication value from every access point 200 times. It is observed from Fig. 2, the measurements of WLAN signal of AP3 at the location coordinate (5, 5) is stochastic and complex induced by the radio multipath effect, interference, reflection, and interference.

The histogram and an approximately probability density function of the measurement form AP3 are shown in Fig. 3. It is clear that the distances are converted with the inevitable mapping error from the received signal strength due to the standard deviation of distribution. In particular, it is difficult to avoid the problem under the unpredictability of

signal propagation through the indoor environments. Thus, indeed a propagation channel model with the adaptation for the RSSI-physical distances mapping is needed for the accurate evaluation for the mobile device location.

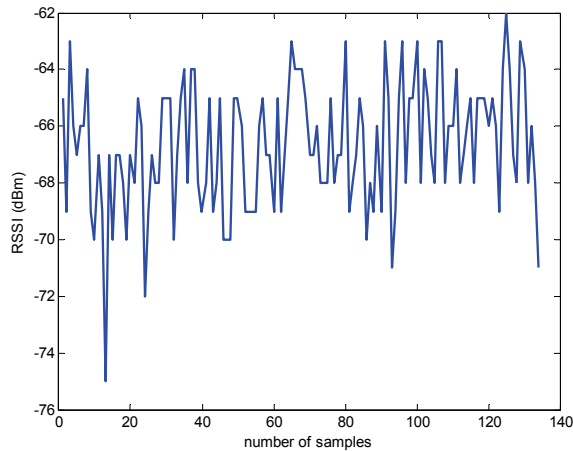

Fig. 2. Measurement from the AP3 at room EE102.

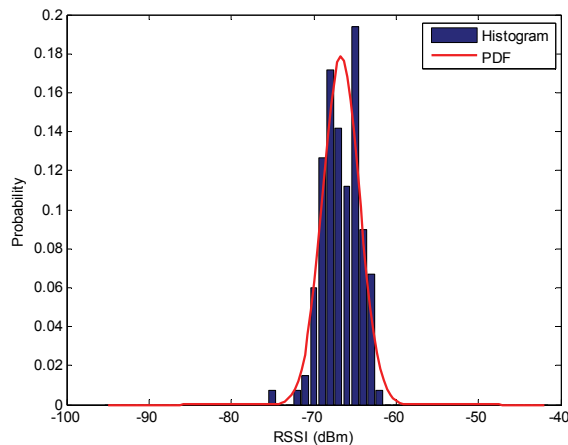

Fig. 3. WLAN signal strength distribution for AP3 at room EE102.

The wireless indoor localization scheme proposed herein is shown in Fig. 4, which is divided into two phases, i.e. offline training phase and online estimation phase. The first step, the training phase (also called calibration phase), is the determination of the dependency between the Received Signal Strength (RSS) and the certain location. It is a challenging task in indoors because of the radio interference, multipath, shadowing, non-line-of-sight propagation caused by the environment characteristics such as walls, humans, and other rigid obstacles. In this study, the RSS-position dependency is characterized using the techniques such as radio propagation model by curve fitting, interpolation, and the neural fuzzy inference system with the training data. The proposed radio propagation

modeling approaches can be used to capture the combined effects of path loss and non-ideal effects mentioned above relating on the empirical data obtained by a mobile device to the distance from an AP. Then the second step, online estimation phase, which is based on the available distance estimates from the positions localized in the test area, is determined by using the extended Kalman filtering.

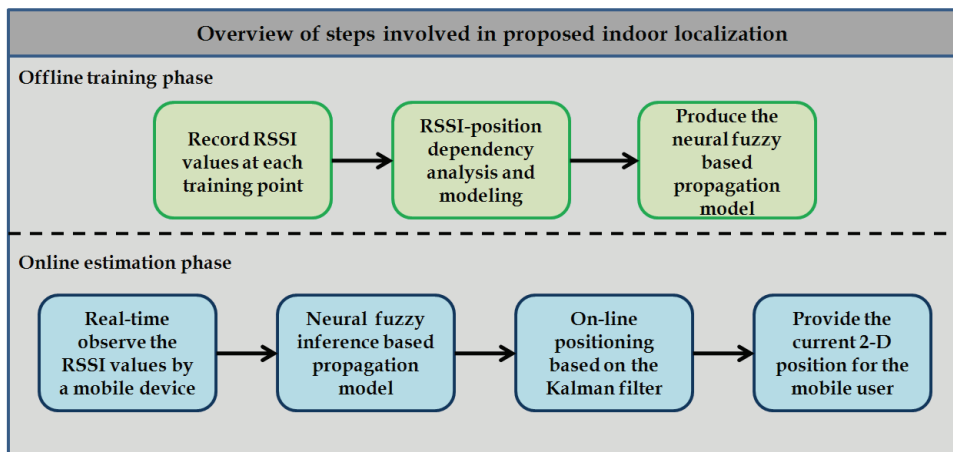

Fig. 4. Overview of the proposed indoor localization.

### 3. Indoor propagation channel modeling

The WLAN indoor positioning relies on the knowledge obtained in the training phase. A good training procedure should have two features: an accurate mapping relationship based on a large quantity of the empirical data, and a radio map training procedure that is not too complex. These two objectives, however, are often in conflict. To obtain an accurate mapping relationship requires a large number of samples, resulting in a heavy burden on the training procedure and computing load. To trade off these two objectives, three kinds of methodologies for channel modeling in the training scheme are addressed as bellow.

The path loss is the loss between the transmitting antenna and receiving antenna and can be described as

$$L = P_{TX} - P_{RX} , \tag{1}$$

where  $L$  is the total power loss which is caused by indoor channel effects,  $P_{RX}$  and  $P_{TX}$  are received signal power and transmitted signal power, respectively, in the unit of dBm.

The RSSI values are converted to the physical distances by using a radio wave propagation model (Rappaport, 2001) in model-based localization typically. The model gives the distance  $d$  as

$$P_{RX} = P_{TX} + G_{TX} + G_{RX} + 20 \log(\lambda) - 20 \log(4\pi) - 10n \log(d) - X_{\alpha} . \tag{2}$$

In (2),  $d$  (meter) is the distance between the transmitter and the receiver.  $P_{TX}$  (dBm) is the transmitting power and  $P_{RX}$  (dBm) is the power level measured by the receiver of the mobile

device.  $G_{TX}$  (dBi) and  $G_{RX}$  (dBi) are antenna gains respectively to the transmitter and the receiver. Wavelength is  $\lambda$  (meter) and  $n$  denotes influence of walls and other obstacles. Error is also included in the equation by  $X_\alpha$  which is a normal random variable with standard deviation  $\alpha$ . To reduce the converting error between the path loss and the corresponding distance, subject to the training data, three techniques of propagation modeling, curve fitting, interpolation, adaptive neural fuzzy network inference system, are presented as follow to decrease the false positioning.

### 3.1 Curve fitting

First, the curve fitting technique is applied based on the polynomial regression (Rao, 2002) with the least-squares error sense to realize the propagation model while the RSSI data exhibiting a nonlinear behavior with physical distances at a mobile device to the access points. The polynomial regression can be used by assuming the following relationship:

$$y_{RSS} = a_0 + a_1 d_x + a_2 d_x^2 + \dots + a_m d_x^m, \quad (3)$$

where  $y_{RSS}$  is the path loss approximation function with respect to the traveled distance, the constants  $a_0, \dots, a_m$  are the parameters for polynomial regression and  $d_x$  is the distance between the receiver and the transmitter. If there are  $N$  training data points  $(d_{x_i}, y_{RSS_i})$ ,  $i = 1, 2, \dots, N$ , the error  $e_i$  for the  $i^{\text{th}}$  data point is defined by

$$e_i = y_{RSS_i} - (a_0 + a_1 d_{x_i} + a_2 d_{x_i}^2 + \dots + a_m d_{x_i}^m). \quad (4)$$

The sum of the squared error is given by

$$S = \sum_{i=1}^N e_i^2 = \sum_{i=1}^N \{y_{RSS_i} - (a_0 + a_1 d_{x_i} + a_2 d_{x_i}^2 + \dots + a_m d_{x_i}^m)\}^2. \quad (5)$$

The order of polynomial fit,  $m$ , is chosen as 2, 3 and 5, respectively, to illustrate the results of propagation modeling by the curve fitting with the training data. It can be observed from Fig. 5, usually the low-order polynomials are used to obtain a better fit. For  $m \geq 4$  or 5, the approximation tends to become ill conditioned and the round-off errors make the solution of coefficients  $a_0, \dots, a_m$  inaccurate.

### 3.2 Interpolation

The theoretical model (2) is usually adopted to present the ideal relationship between the signal power and distance under known parameters of the transmitter and the receiver. The localization method based on such an ideal model is inaccurate since it is impossible in that the perfect modeling for specific conditions of the indoor environment, e.g. multipath and shadowing. Hence, an interpolation method is proposed to solve the propagation modeling without any unknown parameters by using the training data collected in the offline phase. This approach is employed to remove the unknown parameters in (2) by two Reference Nodes (RN). Define  $RN_j^i$  as the  $j^{\text{th}}$  RN with respect to the  $i^{\text{th}}$  access point, where  $i = 1, \dots, M$ ,  $M$  is the number of detectable access point, ( $M=4$  in this work) and  $j=1, 2$ .  $RN_j^i$  can be chosen from the training points and corresponding RSSI values. Therefore, it is clear that

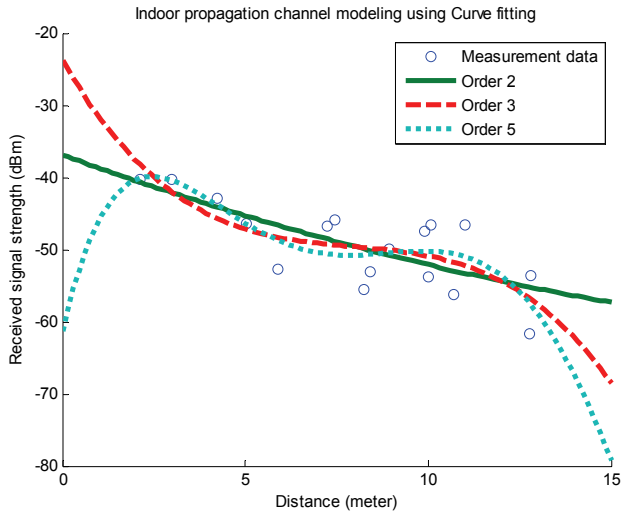

Fig. 5. Propagation modeling based on curve fitting using the polynomial with order 2, 3 and 5.

$$P_{RX1} = P_{TX} + G_{TX} + G_{RX} + 20 \log(\lambda) - 20 \log(4\pi) - 10n \log(d_1) - X_{\alpha}, \tag{6}$$

and

$$P_{RX2} = P_{TX} + G_{TX} + G_{RX} + 20 \log(\lambda) - 20 \log(4\pi) - 10n \log(d_2) - X_{\alpha}, \tag{7}$$

where  $d_1$  and  $d_2$  are two arbitrary reference distance,  $P_{RX1}$  and  $P_{RX2}$  are corresponding received power computed by (2). From (6) and (7), it is not hard to derive the interpolation model by  $(P_{RX} - P_{RX2}) / (P_{RX1} - P_{RX2})$  such that

$$P_{RX} = (P_{RX1} - P_{RX2}) \frac{\log(d) - \log(d_2)}{\log(d_1) - \log(d_2)} + P_{RX2}. \tag{8}$$

Figure 6 gives an illustration for the propagation modeling based on the interpolation method which shares the first reference node ( $RN_i^j, i=1, \dots, 4$ ) that  $P_{RX1}$  equals to -44.9 dBm and  $d_1$  is referred to 2.1 meter and combines another RN. The all points, A to L, are the candidates of  $RN_j^i$  for the interpolation method.

In Fig. 7, it is obviously that the presented approach using the different reference nodes and referred RSSI values can be used to provide severe propagation models with distinct characteristics and attenuations for the adaption of the environment. The proposed interpolation methodology could be not only extended to perform a large scale test environment wireless positioning but also realize a converting for RSS-position dependency without any hardware parameter and the existing environment knowledge. Therefore, an optimum modeling may be provided by trying for the combination of different reference nodes to yield a better performance for the indoor localization.

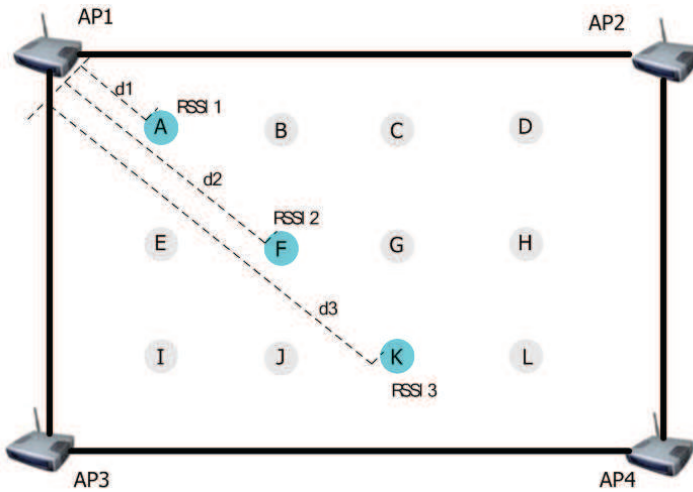

Fig. 6. An example for the interpolation method based modeling with different chosen from RNs.

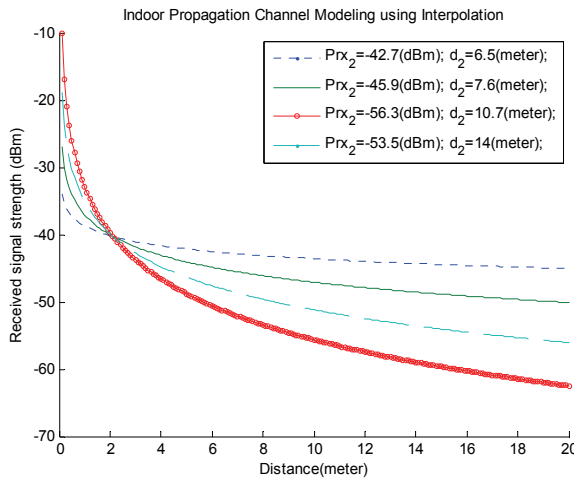

Fig. 7. An Example for interpolation based model by using empirical data collected form AP1.

**3.3 Adaptive neural fuzzy inference system**

In this subsection, a hybrid intelligent approach for the radio propagation modeling is proposed. We combine the ability of a neural network to learn with the fuzzy logic to reason in order to form an adaptive neural fuzzy inference system (Jang, 1993) with Takagi & Sugeno fuzzy rules whose consequents are linear combinations of their preconditions. A fuzzy inference system is a knowledge representation where each fuzzy rule describes a local behavior of the system. The goal of ANFIS is to find a model or mapping that will correctly associate the inputs (RSSI values) with the target (physical distances). For



simplicity, assume that the system has two inputs  $x_1$  and  $x_2$ , and one output  $y$ , the rule base contains two TSK fuzzy rules as follows:

$$R^1 : \text{If } x_1 \text{ is } A_1^1 \text{ AND } x_2 \text{ is } A_2^1, \text{ THEN } y \text{ is } f_1 = a_0^1 + a_1^1 x_1 + a_2^1 x_2 ;$$

$$R^2 : \text{If } x_1 \text{ is } A_1^2 \text{ AND } x_2 \text{ is } A_2^2, \text{ THEN } y \text{ is } f_2 = a_0^2 + a_1^2 x_1 + a_2^2 x_2 .$$

The corresponding architecture of ANFIS is shown in Fig. 5, where  $\mu_{A_j^i}(x_i)$  is called the Membership Function (MF) for the fuzzy set  $A_j^i = \{x, (\mu_{A_j^i}(x)) | x \in X\}$ , for  $i=1,2$  and  $j=1,2$ ,  $X$  is referred to as the universe set. The connected structure shown in Fig. 8, the input and output nodes represent the training values and the predicted values, respectively, the different layers with their meaning are described as bellow:

Layer 1. Every node in this layer acts as an MF, and its output specifies the degree to which the given  $x_i$  satisfies the quantifier  $A_j^i$ .

Layer 2. Every node in this layer is labeled  $\Pi$  and multiplies the incoming signals  $\alpha_j = \mu_{A_j^i}(x_i) \cdot \mu_{A_i^j}(x_j)$  and sends the product out.

Layer 3. Every node in this layer is labeled  $N$  calculates the normalized firing strength of a rule such as  $\tilde{\alpha}_j = \alpha_j / (\mu_{A_j^i}(x_i) + \mu_{A_i^j}(x_j))$ .

Layer 4. Every node in this layer calculates the weighted consequent value  $\tilde{\alpha}_j f_j = \tilde{\alpha}_j (a_0^j + a_1^j x_1 + a_2^j x_2)$

Layer 5. This layer sums all incoming signals to obtain the final inferred result.

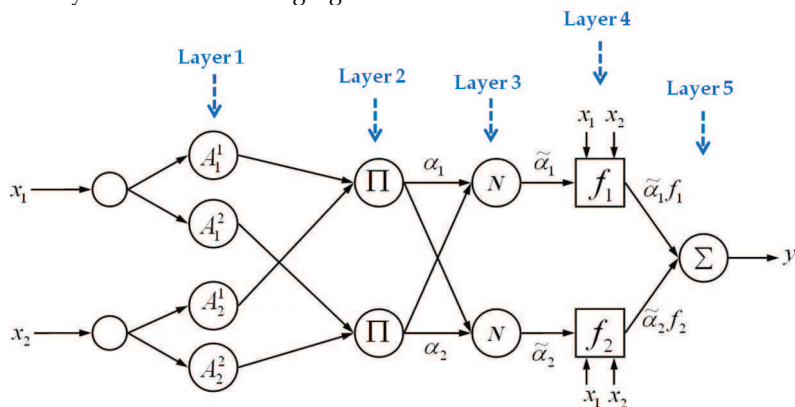

Fig. 8. An illustration of reasoning mechanism for the ANFIS architecture.

For the given input values  $x_1^*$  and  $x_2^*$ , the inferred output  $y^*$  is calculated by

$$y^* = \frac{\alpha_1 f_1(x_1^*, x_2^*) + \alpha_2 f_2(x_1^*, x_2^*)}{\alpha_1 + \alpha_2} . \tag{9}$$

The learning algorithm for ANFIS is a hybrid algorithm with an error measure  $E = \sum_{k=1}^p e_k^2$ , which is a combination of gradient descent and the least-squares method, where  $e_k$  is

$f_k - \hat{f}_k$ ,  $f_k$  and  $\hat{f}_k$  are  $k^{\text{th}}$  desired and estimated output, respectively, and  $p$  is the total number of the pairs (inputs-outputs, i.e. RSSI-distances) of data in the training set. An illustration can be observed from Fig. 9, the Gaussian membership function based ANFIS is used to approximate the propagation model according to the training data collected from the received signal strength indication values in the offline training phase. It is clear that a better and reasonable approximation can be provided by lower number of MF whereas the failed mapping is caused by over training that too many MFs and training pairs are applied. The advantages of the neural fuzzy hybrid technique include the sufficient nonlinear regression ability, fast learning from linguistic knowledge, and its adaptation capability. Therefore to reach a good indoor propagation model, the key point is whether the test environment is exactly characterized by the chosen empirical data set with a proper amount and the type of MF.

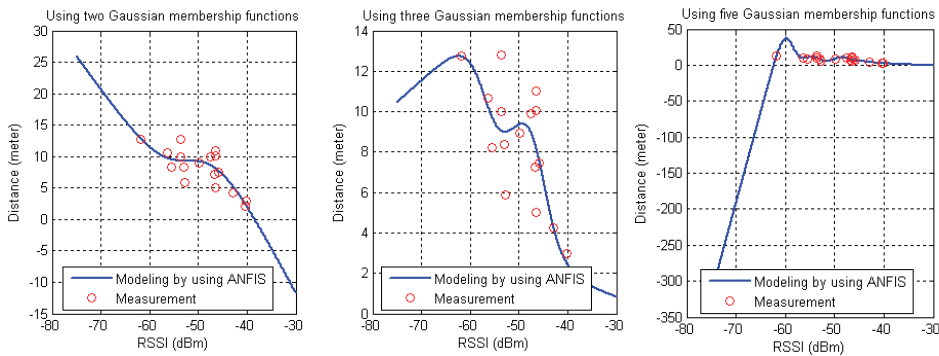

Fig. 9. Propagation modeling by using the ANFIS.

#### 4. Location estimation method

For the online phase, the real-time recursive wireless indoor positioning, the RSS is continuously scanned as a fingerprint or the dependency information on position of the mobile device for the proposed positioning system. Relying on this RSS-position dependency information for wireless positioning, the distance of a mobile device to the access point is provided by the propagation model developed in Section 3, and then, an Bayesian framework estimation, the extended Kalman filter, is used to recursively compute the 2-D mobile device position with the basis of distance estimates. The EKF was selected because it could blend the information optimally with minimizing the variance of the estimation error. A detailed description of the principle of the extended Kalman filter can be found in (Haykin, 2002).

A formulation of the location estimation as a filtering problem in state-space form is addressed here. The general form of the dynamical model is given by

$$x_k = f(x_{k-1}, u_k, w_{k-1}), \tag{10}$$

$$z_k = h(x_k, v_k), \tag{11}$$

where  $k$  is the estimation step,  $u_k$  is the optional control input,  $z_k$  are the output measurements, and  $x_k$  is the system state. Further, in (10) and (11),  $w_{k-1}$ ,  $v_k$  are the

discrete white, Gaussian zero-mean, independent state and measurement noise processes, and  $Q, R$  are their covariance matrices, respectively.

$$E[w_i w_k^T] = Q_i \delta_{ik}, \tag{12}$$

$$E[v_i v_k^T] = R_i \delta_{ik}, \tag{13}$$

where  $\delta(\cdot)$  is the delta function

$$\delta_{ij} = \begin{cases} 1, & i = j \\ 0, & i \neq j \end{cases}. \tag{14}$$

In our case, the state-space is

$$\begin{aligned} x_k &= f(x_{k-1}, 0, w_{k-1}), \\ &= x_{k-1} + w_{k-1} \end{aligned}, \tag{15}$$

$$\begin{aligned} z_k &= h(x_k, v_{k-1}) \\ &= h_d(x_k) + v_{k-1} \end{aligned}, \tag{16}$$

where  $h_d(x)$  is the distance between the location of a mobile device user and a access point, which can be written as a function of the device positions:

$$h_{d_i}(x) = \sqrt{\sum_{j=1}^2 (x_{i,j} - x_j)^2}, \tag{17}$$

where  $i$  is the index of the access points,  $h_{d_i}$  is the distance between the mobile device user location and the  $i^{\text{th}}$  access point,  $x_{i,j}$  and  $x_j$  are the  $j^{\text{th}}$  coordinate element of the  $i^{\text{th}}$  access point and mobile device.

Due to the nonlinearity of the mathematical model (17), the EKF is proposed to calculate the mobile device user location  $\hat{x}_k$ . The algorithm of the EKF can be given as follows:

Time update equations:

$$\hat{x}_k^- = f(x_{k-1}, u_k, 0) \tag{18}$$

$$P_k^- = A_k P_{k-1} A_k^T + W_k Q_{k-1} W_k^T \tag{19}$$

Measurement update equation:

$$K_k = P_k^- H_k^T (H_k P_k^- H_k^T + V_k R_k V_k^T)^{-1} \tag{20}$$

$$\hat{x}_k = \hat{x}_k^- + K_k (z_k - h(\hat{x}_k^-, 0)) \tag{21}$$

$$P_k = (I - K_k H_k) P_k^- \tag{22}$$

where

$$A = \left. \frac{\partial f(\hat{x}_{k-1}, u_{k-1}, 0)}{\partial x} \right|_{x=\hat{x}_k}, \tag{23}$$

$$W = \left. \frac{\partial f(\hat{x}_{k-1}, u_{k-1}, 0)}{\partial w} \right|_{x=\hat{x}_k}, \tag{24}$$

$$H = \left. \frac{\partial h(x_k, 0)}{\partial x} \right|_{x=\hat{x}_k}, \tag{25}$$

$$V = \left. \frac{\partial h(x_k, 0)}{\partial v} \right|_{x=\hat{x}_k}, \tag{26}$$

$K$  is the gain matrix and  $P$  is the estimation error covariance. The super minus notation  $\hat{x}_k^-$  denotes the a priori state estimate at step  $k$  and  $\hat{x}_k$  the a posteriori state estimate given measurement  $z_k$ .

### 5. Experimental results

As shown in Fig. 10, the WLAN positioning accuracy of the proposed methods is evaluated using real data from a classroom environment, located on the first floor of EE building at the Chiao Tung University. The dimension of the experimentation area is 37.4 meters by 20.6 meters with a total of 4 access points detectable only, and each one of the detectable access points provides only partial coverage of the environment. The RSSI measurements were scanned and collected from the network card using an application program implemented on the Dopod PDA (200MHz CPU) at the sampling rate of 2 samples/second. The RSS values were collected for 53 training points with a separation of 2.5 meters. For each point, the WLAN client gathered RSSI values from each detectable access point 200 times with a total of 10,600 measurements. As addressed in Section 3, this training set is used to obtain the

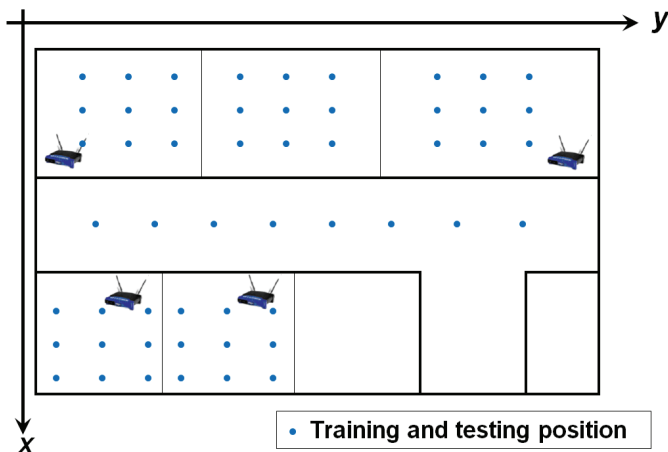

Fig. 10. Experimental area. The blue dots are the training and testing locations.

indoor propagation model in the offline phase, hence the distances of a mobile device to the access points can be estimated for the online phase and recursively compute the position of the mobile device.

The proposed positioning system is evaluated by the real-time estimation at each testing point. The testing data are collected at the same location where the training data are recorded. Also, the mobile device gathered the RSSI values from each access point 200 times for the filtering iteration at every testing point. There are four measurement is available for the EKF at each iteration step since only four access points are detectable in this test area. Even the four-dimensional measurement state (11) is used, the presented approach is certainly straightforward and can be implemented by the real-time computing on a PDA.

### 5.1 Curve fitting

Recall the model developed in the subsection 3.1. The propagation model can be approximated by a curve fitting with nonlinear regression. It is hard to provide the solution of the coefficients of the polynomial fit if the order is high since the high order based nonlinear regression will result an ill conditioned polynomial fit. To omit the trivial test results under the order higher than seven, only four meaningful location error statics are summarized in Fig. 11. On the other hand, the Cumulative Distribution Function (CDF) of the location errors is shown in Fig. 12, it is clear that the best determination of the position is based on first order regression of polynomial fit and achieves improvements of 7.35 m (70%) over the 3rd order, 5 m (55.6%) over the 5<sup>th</sup> order, and 2.05 m (30%) over the 7<sup>th</sup> order at 70<sup>th</sup> percent. Obviously, the mean error with the first order regression compared to the other three cases are much better not only on the accuracy but also on the precision.

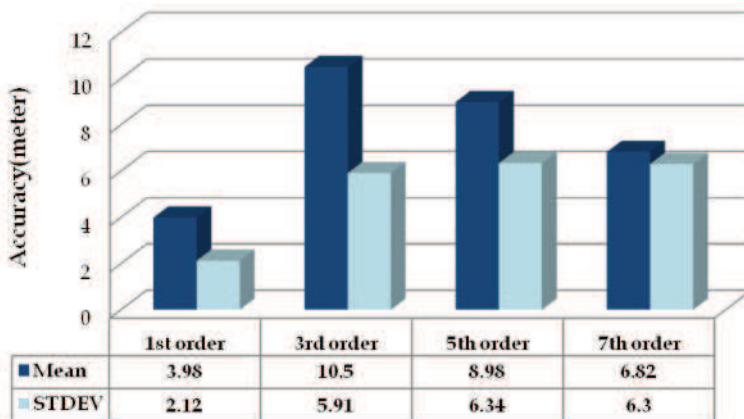

Fig. 11. Statistics of the positioning error based on the curve fitting models.

### 5.2 Interpolation

In this section, the localization scheme using parameter-free propagation models based on the differences in signal attenuations for WLAN signals would be introduced. Due to the individual characteristics of each detectable access point, the propagation models are modified by the combination of the reference nodes. Table. 1 shows the four kinds of choosing reference nodes. However, they might not be the optimal results relate to all possible arrangement of

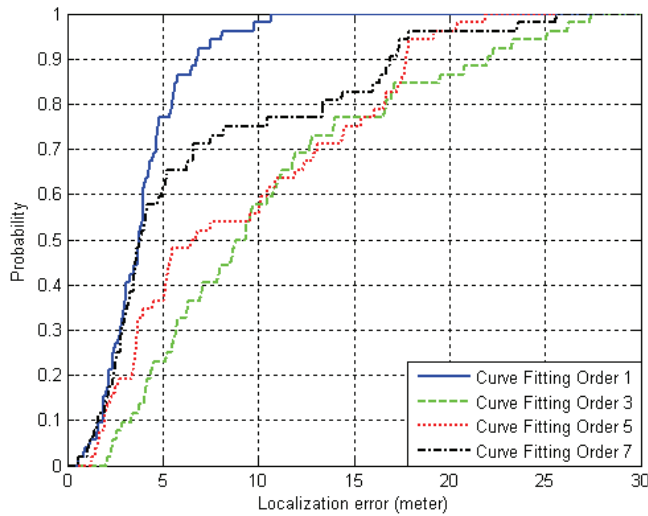

Fig. 12. CDF of the location errors based on the curve fitting models.

$RN_j^i$  while the total number of the possibility of the combination with any two reference nodes from the sampled data is too large to test by trying. In contrast, the empirical data set based interpolation has a high potential to provide a most fit propagation model by associating with some intelligent algorithms.

Positioning case	AP	AP1		AP2		AP3		AP4	
	RN	$RN_1^1$	$RN_2^1$	$RN_1^2$	$RN_2^2$	$RN_1^3$	$RN_2^3$	$RN_1^4$	$RN_2^4$
Case1	Distance (m)	5.50	8.54	3.68	18.81	2.37	6.60	3.71	6.54
	RSSI (dBm)	-41.05	-54.61	-37.12	-72.14	-37.76	-60.35	-41.66	-55.66
Case2	Distance (m)	9.24	17.67	5.03	12.39	3.39	5.34	4.28	6.91
	RSSI (dBm)	-50.84	-76.55	-42.30	-66.79	-41.99	-50.65	-41.99	-55.65
Case 3	Distance (m)	6.34	9.94	5.76	19.96	3.52	7.59	7.82	15.51
	RSSI (dBm)	-43.33	-54.2	-40.91	-71.37	-40.00	-54.16	-64.61	-90.00
Case 4	Distance (m)	10.54	19.17	5.80	17.37	5.94	11.51	2.83	8.13
	RSSI (dBm)	-54.09	-74.16	-41.49	-72.22	-49.05	-86.88	-41.38	-61.87

Table 1. Reference nodes and parameters of the interpolation models.

Figure 13 indicates that four better positioning results are picked up to demonstrate the indoor propagation model based on the interpolation with the parameters selected in Table 1. The RN chosen under case 3 presents the best accuracy related to the others due to matching of the real RSS-position dependency for the interpolation model.

The accuracy under case 3 achieves the improvements at least 23.9 percentage over the other cases. It can be seen in Fig. 14, the CDF shows that the reduced location error under case 3 compared to the cases 1, 2 and 4 are 1.93 m (35%), 1.43 m (27.8%) and 2.04 m (36.6%) at 70<sup>th</sup> percent, respectively. The proposed interpolation modelling technique does not require a known and accurate path loss modeling, reduces the impact of shadowing on location, and is capable of being applied in existing systems without hardware development.

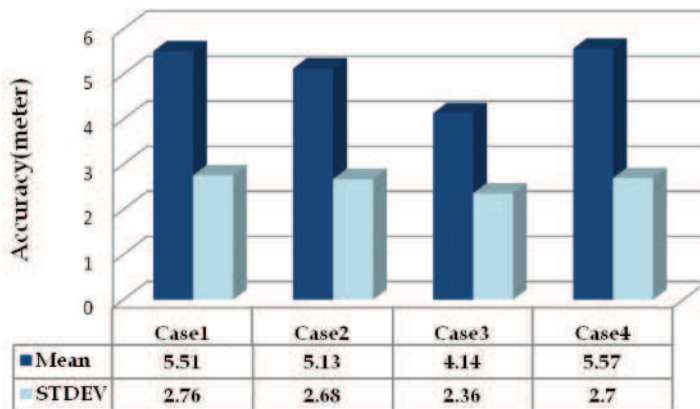

Fig. 13. Statistics of the positioning error based on the interpolation models.

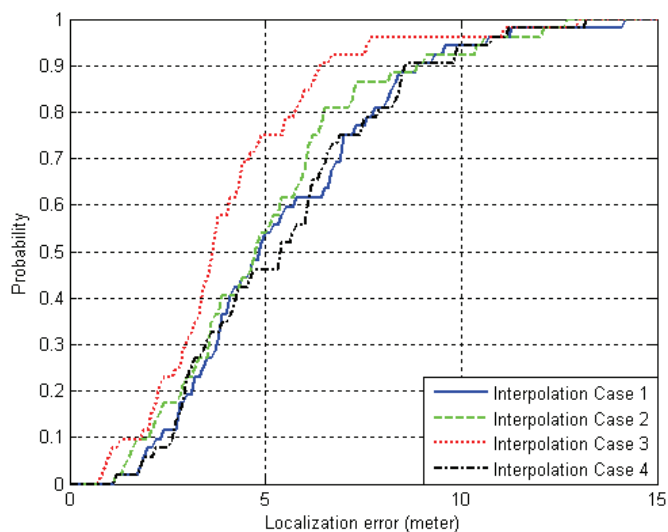

Fig. 14. CDF of the location errors based on the interpolation models.

### 5.3 Adaptive neural fuzzy inference system

During the offline stage, RSS and the corresponding distance between the mobile device and the access point are adopted as the inputs and targets for the learning purpose using the ANFIS, the type and number of the membership used to train the ANFIS is on the basis of arrangement in Table. 2. There are 53 training pairs consisted of the RSS values and corresponding positions with a total of 10600 sampled data collected from the WLAN positioning area. After training of the ANFIS, the appropriate are obtained. For the online stage, the trained adaptive neural fuzzy inference system acts as a mapping function which converts the RSSI values to the physical distances between the mobile device and the access points in real-time.

Positioning Case	Membership Function Type	Number of Membership Function
1, 2, 3 and 4	Bell-shaped	2, 3, 4 and 5
5, 6, 7 and 8	Triangle	2, 3, 4 and 5
9, 10, 11 and 12	Trapezoid	2, 3, 4 and 5
13, 14, 15 and 16	Gaussian	2, 3, 4 and 5

Table 2. Positioning cases with different types and the number of MF.

Reducing the complexity of the whole wireless positioning system, the learning results of ANFIS for mapping are summarized in a lookup table which can be used to estimate the physical distances without the loss of accuracy since the ANFIS is optimized under the gradient descent and the least-squares method with the error measure described in the subsection 3.3. The total of 16 cases are tested for verifying the accuracy of the WLAN positioning based on the ANFIS propagation models, which are given in Table. 3. The learning results tend to be over training that diverge the location errors if the the number of the MF is larger than 5, those results are trivial and not mentioned here. It can be seen from Table. 3 that the cases have the best accuracy and precision is the positioning based on the ANFIS models using the bell-shaped MF.

Membership function type	Localization error (m)					Averaged performance (m)	
	Error evaluation	Number of membership function				Mean	STDEV
		2	3	4	5		
Bell-shaped	Mean	3.76	3.57	3.60	3.64	3.64	0.08
	STDEV	2.03	2.07	2.06	2.33	2.12	0.13
Triangle	Mean	6.47	7.82	8.40	4.72	6.85	1.63
	STDEV	6.71	10.96	11.93	2.93	8.13	4.14
Trapezoid	Mean	3.80	3.68	3.93	4.22	3.90	0.23
	STDEV	2.02	2.06	2.20	2.60	2.22	0.26
Gaussian	Mean	4.01	3.63	3.70	3.79	3.78	0.16
	STDEV	2.08	2.04	2.06	2.35	2.13	0.14

Table 3. Statistics of the positioning error based on the ANFIS models.

The average performance shown in Table 3 is yielded by averaging the mean location errors with respect to different numbers of MF, and indicates that the results based on Gaussian, bell-shaped and trapezoid type MF are similar because of similar accuracy. Figure 15 shows the CDF for the best location error regard to the each MF type, it can be seen that the positioning based on the Gaussian, bell-shaped and trapezoid MF almost have the same good statistics and achieve the improvements of 31.9% over estimation using triangle MF. Clearly, there are many benefits of the proposed ANFIS approach for the modelling or the prediction. It combines two techniques, the neural networks and fuzzy systems, by using the fuzzy techniques, both numerical and linguistic knowledge can be combined into a fuzzy rule base, the combined fuzzy rule base represents the knowledge of the network structure so that structure learning techniques can be accomplished easily. Fuzzy membership functions can be tuned optimally by using learning methods, and the architecture



requirements are fewer and simpler compared to neural networks, which require extensive trials and errors for optimization of their architecture. Therefore the accurate indoor propagation approximation can be provided by the proposed ANFIS based method.

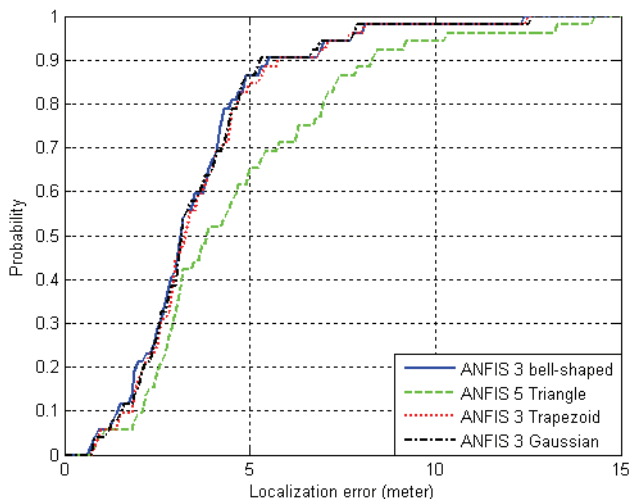

Fig. 15. CDF of the location errors based on the ANFIS models.

### 5.4 Comparisons

1) *Related work:* (Bahl & Padmanabhan, 2001) proposed an in-building user location and tracking system - RADAR, which adopts the nearest neighbors in signal-space technique, which is the same as  $k$ NN positioning based on averaging  $k$  closest location candidates. They proposed the method based on the empirical measurement of access point signal strength in offline phase. By these experiments, it is reported that user orientations, number of nearest neighbors used, number of data points, and the number of samples in real-time phase would affect the accuracy of location determination. The proposed WLAN positioning is compared with RADAR in case  $k=3,5,7$ , and 9.

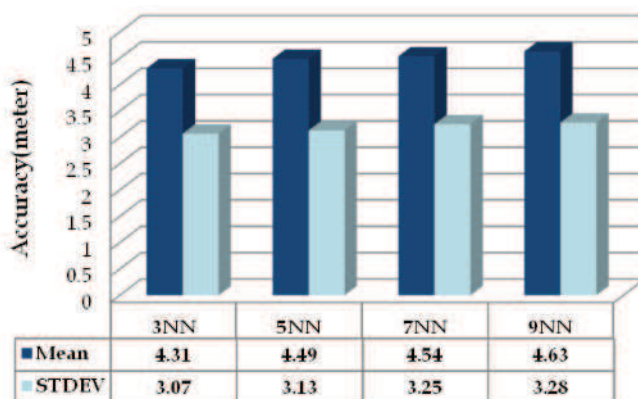

Fig. 16. Statistics of the positioning error based on RADAR.

The RADAR based WLAN positioning is very popular because of its low complexity of algorithm and efficiency. Figure 16 shows the statistics of the location error based on the RADAR, the best accuracy error mean of 4.31 m is provided by using three nearest neighbors while the positioning errors tend to be increasing if more neighbors are referred. This is caused by the referring fault by ill conditioned neighbor candidates which are too far to the real position of the mobile device location.

2) *Comparison and Verification of accuracy in a mobile device:* In order to ensure fair comparison of the positioning results, the proposed approaches mentioned before and the related work RADAR were implemented on the same simple mobile device, a Dopod PDA (200MHz). To carefully verify the performance of the accomplished experimentation, the best positioning results regard to each approach mentioned above in this chapter are compared hereon to demonstrate the performance of the proposed method. For convenience, a summary of error statistics for each method is provided in Fig. 17.

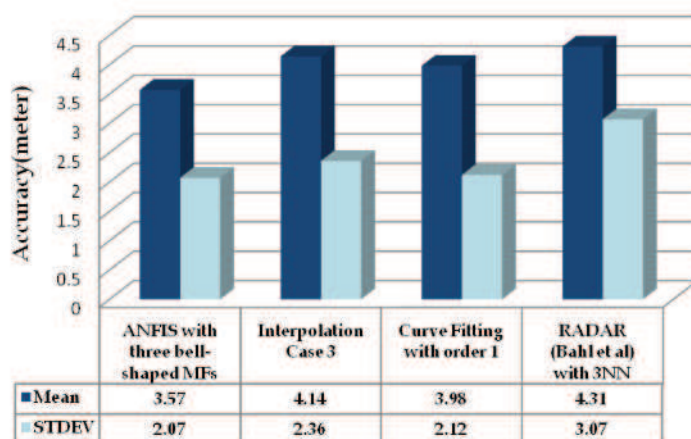

Fig. 17. Statistics of the positioning error for each method.

The improvements of error mean of WLAN positioning based on ANFIS with three bell-shaped MFs compared to the interpolation, curve fitting and RADAR are 0.57m (13.7%), 0.41m (10.3%) and 0.74m (23.2%). The precision of the proposed WLAN localization using the ANFIS based propagation model has a relatively best standard deviation 2.07 m whereas the poorest one is 3.07m provided by the RADAR algorithm, so that ANFIS based approach achieves the improvements of 12.2% over the interpolation, 2% over the curve fitting and 32.5% over the RADAR algorithm.

In addition, Fig. 18 shows that the CDF of the location errors for the best cases of each approach. Using ANFIS, interpolation, curve fitting and RADAR, 50% of the location errors are within 3.2 m, 3.7 m, 3.81 m, and 3.65 m, respectively; 90% of the location errors are below 5.52 m, 6.41 m, 6.83 m, and 7.03 m, respectively. It is clear that the CDF of the ANFIS based result is the most left respected to the other approaches. Investigating the proposed WLAN localization by the time response is another point of view for verifying the performance, which is shown in Fig. 19.

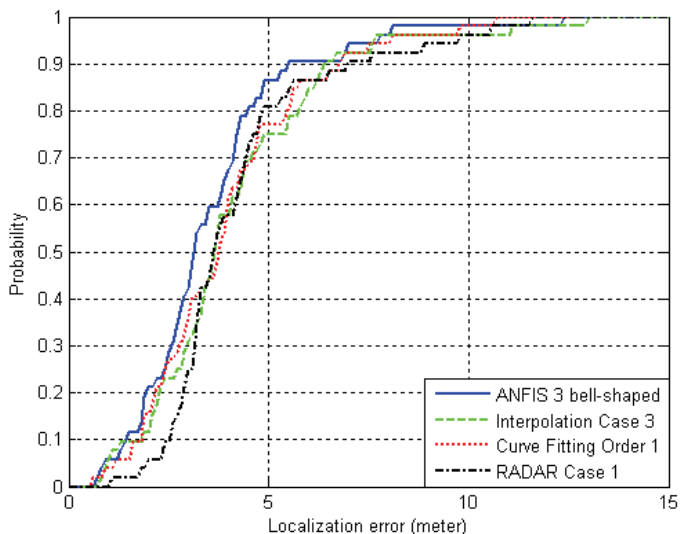

Fig. 18. CDF of the location errors for the best cases of each approach.

Since the structure of the test area is complex due to many walls surround of the classrooms, rigid obstacles and clustered human, the noise and shadowing from the environment are deteriorating the positioning precision, especially the RADAR algorithm is easily to be influenced because there is no filtering scheme used to enhance and track the position state by referring previously states. In contrast, the positioning based on the proposed ANFIS propagation model with the well adaptation capability has a fast convergence and tend to be the best accuracy after about 20 transition iterations.

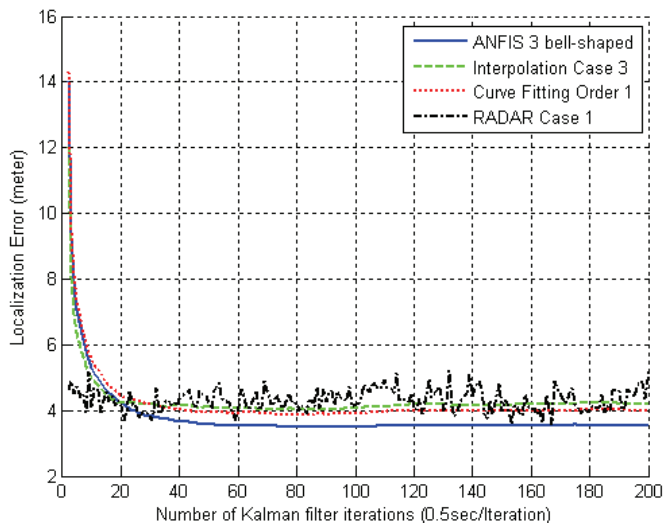

Fig. 19. Time response of error mean for the best case of each method.

## 6. Conclusions

In this study, a low complexity WLAN indoor positioning system based on the curve fitting, the interpolation, and an adaptive neural fuzzy system is addressed. The proposed modeling techniques are used to reduce the false distance estimation of a mobile device to the access points induced by the unpredictable interference, reflection and multipath effects. It is clear that the experimental results show that an empirical propagation model can be easily provided by the curve fitting based approach but involves a limited flexibility and adaptation; the interpolation based approach has a simple computation for the distance estimation and a high flexibility due to the possible arrangement of the reference nodes but requires horrible trails and errors for optimization. Therefore a hybrid learning algorithm under a combination of gradient descent and the least-squares method based neural fuzzy inference system is proposed to solve the problems mentioned above. Due to its nonlinear ability, fast learning capacity and adaptation capability, the accurate distance estimates of a mobile device to the access points can be obtained. The distances are firstly converted by the addressed ANFIS propagation model during the online stage in real-time with the currently observed RSSI value from the tested WLAN area. The available distances from the positions localized in the test bed are recursively estimated by an extended Kalman filter while it could blend the information optimally minimizing the variance of the estimation error.

Consequently, the presented approach is verified to provide the accurate localization in the real indoor environment of 20.6m×37.4m with 4 access points only. The addressed positioning algorithm is straightforward and can be implemented by simple mobile devices, such as PDAs or mobile phones, to provide the location-aware services without any hardware cost since WLAN signals are popular sensor sources for indoor environments. There are many potential applications for location positioning and network accessing, such as library or museum tour-guide, free mobility and nursing at home, patient transporting in the hospital and easy going capability in the shopping mall.

## 7. Acknowledgment

The work is supported by National Science Council under Grant no. NSC 97-2752-E-009 -003 -PAE.

## 8. References

- Bahl, P. & Padmanabhan V. N. (2000). RADAR: An In-Building RF-Based User Location and Tracking System, *Proceedings of IEEE International Conference on Computer Communications*, pp. 775-784, March, 2000, Israel.
- Wassi, G. I.; Despains, C. & Grenier, D. (2005). Indoor location using received signal strength of 802.11b access point. *Proceedings of the IEEE International Conference on Electrical and Computer Engineering*, pp. 1367-1370, May, 2005, Canadian.
- Li, B.; Salter, J. & Dempster, A. G. (2006). Indoor positioning techniques based on Wireless LAN. *Proceedings of IEEE International Conference on Wireless Broadband & Ultra Wideband Communications*, pp. 13 - 16, March, 2006, Australia.

- Kotanen, A.; Hännikäinen, M. & Leppäkoski, H. (2003). Experiments on local positioning with Bluetooth. *Proceedings of International Conference on Information Technology: Coding and Computing*, pp. 28 – 30, April, 2003, Las Vegas.
- Kotanen, A.; Hännikäinen, M. & Leppäkoski, H. (2003). Positioning with IEEE 802.11b wireless LAN. *Proceedings of IEEE International Symposium on Personal, Indoor and Mobile Radio Communications*, pp.2218-2222, September, 2003, China.
- Ito, S. & Kawaguchi, N., (2005). Bayesian based location estimation system using wireless LAN. *Proceedings of IEEE International Conference on Pervasive Computing and Communications*, pp. 273 – 278, March, 2005, Hawaii.
- Fox, V.; Hightower, J.; Lin, L.; Schulz, D. & Borriello, G. (2003). Bayesian filtering for location estimation. *IEEE Transactions on Pervasive Computing*, Vol. 2, No. 3, pp. 24 – 33.
- Seshadri, V.; Záruba, G. V. & Huberpp M. (2005). A Bayesian sampling approach to in-door localization of wireless devices using received signal strength indication. *Proceedings of IEEE International Conference on Pervasive Computing and Communications*, pp. 75 – 84, March, 2005, Hawaii.
- Morwilli, C.; Nicoli, M.; Rampa, V.; Spagnolini, U. & Alippi, C. (2006). Particle filters for rss-based localization in wireless sensor networks: an experimental study. *Proceedings of IEEE International Conference on Acoustics, Speech and Signal Processing*, pp. 957 – 960, May, 2006, France.
- Battiti, R.; Nhat, T. L. & Villani, A. (2002). *Location-Aware Computing - A Neural Network Model For Determining Location In Wireless Lans*. The University of Trento, Technical Report: DIT-02-0083, 2002.
- Ocana, M.; Bergasa, L. M.; Sotelo, M. A.; Nuevo, J. & Flores, R. (2005). Indoor Robot Localization System Using WiFi Signal Measure and Minimizing Calibration Effort. *Proceedings of IEEE International Symposium on Industrial Electronics*, pp. 1545 – 1550, June, 2005, Croatia.
- Ahmad,U.; Gavrillov, A.; Nasir, U.; Iqbal, M.; Seong, J. C. & Sungyoung, L. (2006). In-building Localization using Neural Networks. *Proceedings of IEEE International Conference on Engineering of Intelligent Systems*, pp. 1 – 6, April, 2006, Pakistan.
- Ivan, V. & Branka, Z. C. (2005). WLAN location determination model based on the artificial neural networks. *Proceedings of IEEE International Symposium on Multimedia Systems and Applications*, pp.287 – 290, June, 2005, Croatia.
- Hatami, A. (2006). Application of channel modeling for indoor localization using TOA and RSS. Ph.D. dissertation, Department of Electrical and Computer Engineering, Worcester Polytechnic Institute, Worcester, England, 2006.
- Teuber, A.; Eissfeller B. & Pany, T. A. (2006). Two-Stage Fuzzy Logic Approach for Wireless LAN Indoor Positioning. *Proceedings of IEEE International Conference on Position, Location, And Navigation Symposium*, pp. 730 – 738, April, 2006, California.
- Rappaport T. S. (2001). *Wireless Communications: Principles and Practice*, 2nd ed. Prentice Hall, ISBN 013-0422-32-0, 2001, New Jersey.
- Jang, J. S. (1993). Adaptive-Network-Based Fuzzy Inference System. *IEEE Transactions on Systems, Man, and Cybernetics*, Vol. 23, No. 3, 1993.

- Haykin, S. (2002). *Adaptive Filter Theory*, fourth edition, Prentice Hall, ISBN 0-13-090126-1, New Jersey.
- Rao, S. S. (2002). *Applied Numerical Methods for Engineers and Scientists*, Prentice Hall, ISBN 0-13-0879480-X, New Jersey.



## **Kalman Filter**

Edited by Vedran Kordic

ISBN 978-953-307-094-0

Hard cover, 390 pages

**Publisher** InTech

**Published online** 01, May, 2010

**Published in print edition** May, 2010

The Kalman filter has been successfully employed in diverse areas of study over the last 50 years and the chapters in this book review its recent applications. The editors hope the selected works will be useful to readers, contributing to future developments and improvements of this filtering technique. The aim of this book is to provide an overview of recent developments in Kalman filter theory and their applications in engineering and science. The book is divided into 20 chapters corresponding to recent advances in the field.

### **How to reference**

In order to correctly reference this scholarly work, feel free to copy and paste the following:

Bing-Fei Wu, Cheng-Lung Jen and Kuei-Chung Chang (2010). Neural Fuzzy Based Indoor Localization by Extending Kalman Filtering with Propagation Channel Modeling, Kalman Filter, Vedran Kordic (Ed.), ISBN: 978-953-307-094-0, InTech, Available from: <http://www.intechopen.com/books/kalman-filter/neural-fuzzy-based-indoor-localization-by-extending-kalman-filtering-with-propagation-channel-modeli>

# **INTECH**

open science | open minds

### **InTech Europe**

University Campus STeP Ri  
Slavka Krautzeka 83/A  
51000 Rijeka, Croatia  
Phone: +385 (51) 770 447  
Fax: +385 (51) 686 166  
[www.intechopen.com](http://www.intechopen.com)

### **InTech China**

Unit 405, Office Block, Hotel Equatorial Shanghai  
No.65, Yan An Road (West), Shanghai, 200040, China  
中国上海市延安西路65号上海国际贵都大饭店办公楼405单元  
Phone: +86-21-62489820  
Fax: +86-21-62489821

© 2010 The Author(s). Licensee IntechOpen. This chapter is distributed under the terms of the [Creative Commons Attribution-NonCommercial-ShareAlike-3.0 License](#), which permits use, distribution and reproduction for non-commercial purposes, provided the original is properly cited and derivative works building on this content are distributed under the same license.