

Effect of DG on distribution grid protection

Edward Coster

*Stedin, Eindhoven University of Technology
The Netherlands*

Johanna Myrzik and Wil Kling

*Eindhoven University of Technology
The Netherlands*

1. Introduction

Up till recently past electric power systems were characterized by centralized production units, a high voltage transmission grid for the bulk energy transmission and medium and low voltage distribution grids to bring the energy to the consumer. Traditionally no generation sources were connected to the distribution grid, however, this has changed significantly the past decade. Nowadays various types of small generation sources, better known as distributed generation (DG), are connected to the distribution grid. Due to CO₂ reduction goals many of the small units integrated in the distribution grid are renewable energy sources, such as wind turbines, small scale hydro plants and photovoltaic panels but also high efficient non-renewable energy sources, such as small Combined Heat and Power (CHP) plants are implemented.

Connection of DG not only alters the load flow in the distribution grid but can also alter the fault current during a grid disturbance. Most distribution grid protective systems detect an abnormal grid situation by discerning a fault current from the normal load current. Because DG changes the grid contribution to the fault current, the operation of the protective system can be affected. This is reported in (Deuse et al., 2007; Doyle, 2002; Kauhamieni & Kumpulainen, 2004), however, in these papers the protection problems are discussed in general terms. In this chapter a detailed analysis of possible protection problems is given. It starts with an analytical description of fault currents in distribution grids including DG. With the aid of the analytical equations the effect of DG on the fault current is studied and key parameters are identified. This chapter also provides an equation to calculate the location where the DG-unit has the most effect on the grid contribution to the fault current. During the design stage of the protective system for a distribution feeder including DG this equation can be applied to determine if protection problems are to be expected. The application of the derived equations are demonstrated on a generic test feeder.

An overview of all possible protection problems is presented and a classification of the protection problems is given. Furthermore these protection problems are linked to the theoretical background which is discussed in the beginning of the chapter. In this part of the chapter solutions for the possible protection problems are presented as well as new developments in protective systems which enables a further integration of DG in distribution grids.

The chapter ends with a case study on a benchmark network which demonstrates the fault detection problem. Dynamic simulations show how the fault detection problems arises and what remedies can be taken to prevent these.

2. Fault currents in faulted distribution feeders including DG

The connection of DG to distribution feeders changes the fault currents in faulted feeders. The rate of change of the fault currents strongly depends on the ability of the DG to contribute to the fault current. DG based on an asynchronous generator does not provide a sustainable fault current during a grid-disturbance. The same holds mostly for inverter-connected DG such as micro-turbines, fuel-cells and PV-systems, from which the fault current contribution can be neglected (Jenkins et al., 2000; Morren & de Haan, 2008). However, in (Baran & El-Markabi, 2004) it is demonstrated that in weak systems, during a high resistive fault, inverter-connected DG although, change the grid contribution to the fault current. This is also reported in (Kumpulainen et al., 2005). The reference (Baran & El-Markabi, 2005) proposes for weak systems an extension of the conventional fault analysis method to include the effect of inverter-connected DG. A generator type that contributes a sustainable fault current is the synchronous generator (Jenkins et al., 2000). These type of generators can be found in small combined heat and power plants. In this section the effect of synchronous generators on the grid contribution to the fault current is considered.

2.1 Theoretical background

To analyse the effect of DG on the fault current in a feeder, a generic feeder is taken as a reference as shown in figure 1. At distance d a DG-unit is connected and at the end of the feeder a three-phase fault is present. For the analysis it is convenient to use a distance parameter to indicate the location of the DG which is relative to the total feeder length. This parameter is defined as:

$$l = \frac{d}{d_{tot}} \quad (1)$$

In equation (1) d is the distance to the DG-unit and d_{tot} is the total feeder length.

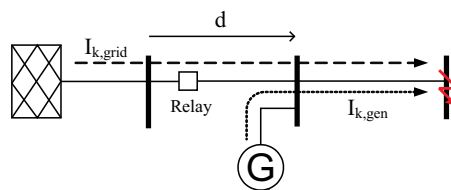

Fig. 1. Short-circuit current contribution of both grid and DG-unit

An electric equivalent of the feeder shown in figure 1 is given in figure 2. In this figure Z_L is the total line-impedance, Z_g the generator-impedance and Z_s the source-impedance. The voltages of the grid and generator are denoted as U_s and U_g .

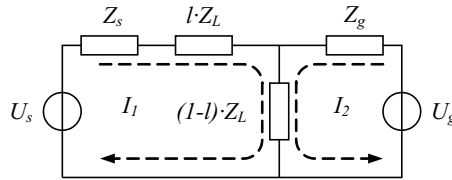

Fig. 2. Network equivalent of figure 1

Defining the mesh currents I_1 and I_2 and applying the Kirchhoff Voltage Law (KVL) for U_s and U_g can be found:

$$\begin{bmatrix} U_s \\ U_g \end{bmatrix} = \begin{bmatrix} Z_s + Z_L & (1-l) \cdot Z_L \\ (1-l) \cdot Z_L & Z_g + (1-l) \cdot Z_L \end{bmatrix} \cdot \begin{bmatrix} I_1 \\ I_2 \end{bmatrix} \tag{2}$$

In figure 2 and equation (2) I_1 is the grid contribution $I_{k,grid}$, and I_2 is the DG-contribution, $I_{k,gen}$, to the total fault current. An analytical expression for I_1 and I_2 can be found by solving equation (2). Because of the strong relation with the IEC60909 fault-analysis method, in this chapter Thevenin’s Theorem is applied on the network of figure 2 to find a analytical expression for $I_{k,grid}$ and $I_{k,gen}$. In figure 3 the Thevenin equivalent of the network of figure 2 is shown.

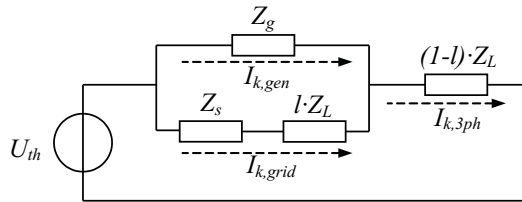

Fig. 3. Thevenin equivalent of figure 1

For this figure the Thevenin impedance is:

$$Z_{th} = \frac{(Z_s + l \cdot Z_L) \cdot Z_g}{Z_s + l \cdot Z_L + Z_g} + (1-l) \cdot Z_L \tag{3}$$

In equation (3) $Z_s = jX_s$ is the grid impedance, $Z_g = jX_g$ is the generator impedance and $Z_L = R_L + jX_L$ is the total line or cable impedance. l is the relative generator location as defined in equation (1). The total three-phase short-circuit current can be calculated by:

$$I_{k,3ph} = \frac{U_{th}}{\sqrt{3} \cdot Z_{th}} \tag{4}$$

Combining equation (3) and equation (4) yields:

$$I_{k,3ph} = \frac{U_{th} \cdot (Z_g + l \cdot Z_L + Z_s)}{\sqrt{3} [(Z_L \cdot Z_g + Z_s \cdot Z_g + Z_s \cdot Z_L) + l \cdot Z_L(Z_L - Z_s) - l^2 Z_L^2]} \tag{5}$$

For the grid contribution holds:

$$I_{k,grid} = \frac{Z_g}{(Z_g + l \cdot Z_L + Z_s)} \cdot I_{k,3ph} \tag{6}$$

Substituting equation (5) in equation (6) gives for the grid contribution:

$$I_{k,grid} = \frac{U_{th} \cdot Z_g}{\sqrt{3} \left[(Z_L \cdot Z_g + Z_s \cdot Z_g + Z_s \cdot Z_L) + l \cdot Z_L (Z_L - Z_s) - l^2 Z_L^2 \right]} \tag{7}$$

The total short-circuit current, $I_{k,3ph}$, is determined by equation (5) which is a non-linear equation, so $I_{k,grid}$ is non-linear as well. In case of a weak grid, Z_s can be as large as Z_g and due to the contribution of the generator, the grid contribution to the short-circuit current decreases.

2.2 Simulation of a 3-bus test network

In the previous section equation (7) describes the grid contribution to the fault current in a distribution feeder including a synchronous generator. This equation shows that the grid contribution will be determined by the total feeder impedance, the local short-circuit power at the substation, the generator size and location. To determine the impact of the synchronous generator on the short-circuit current a 3-bus test network is defined and modeled in simulation software. The test grid consists of an external grid, three MV-nodes which are connected by two connections. At busbar 2 a synchronous generator is connected. The test network is depicted in figure 4 and is used to illustrate the theoretical background.

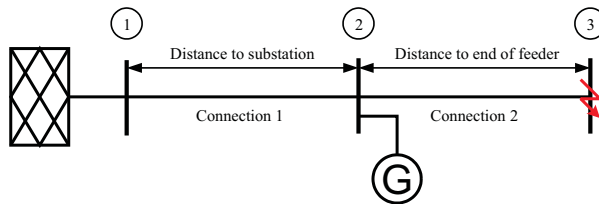

Fig. 4. 3-bus network

To demonstrate the effect of the generator size and its location in the test network these two parameters are modified. For that repetitive calculations have to be performed. The calculations are executed for a regular cable and an overhead line type from what the parameters are shown in table 1.

Type	R [Ω /km]	X [Ω /km]	I_{nom} [A]
XLPE 630 mm ² Al	0.063	0.109	575
DINGO 19/.132	0.218	0.311	525

Table 1. Cable and overhead line parameters of the 3-bus test network

The length of both connections is adjusted by 10% of the total feeder length. To keep an equal total feeder length, connection 1 is increasing and connection 2 is decreasing with the same

step size. In this way node 2 is shifting from node 1 to node 3 and the effect of the location of the generator can be observed. After the modification of the length of the connections a three-phase fault calculation at busbar 3 is performed. This fault calculation is based on the well known IEC 60909 method and per step size the grid contribution is stored. For each step the generator size is increased with steps of 2 MW with a maximum of 10 MW.

The result is shown in figure 5 and it can be seen clearly that the generator has an effect on the grid contribution to the fault current. As expected, large size generators influence the grid contribution more than small size generators.

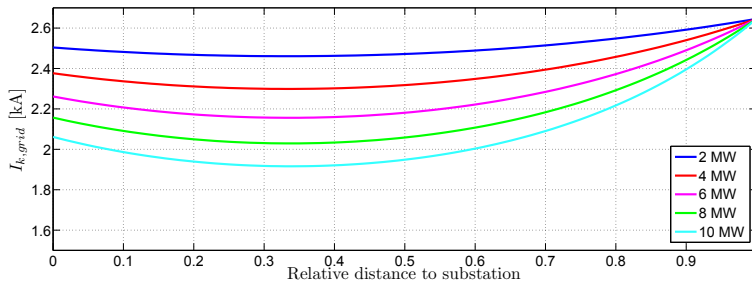

(a) Results for the cable case

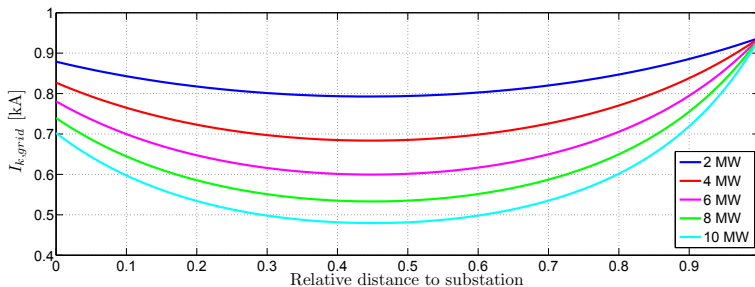

(b) Results for the overhead line case

Fig. 5. Simulation results for the 3-bus test network

Due to the difference in design the impedance of a cable system differs from the impedance of overhead lines. In table 1 it can be seen that the impedance of the overhead line is larger than the impedance of the cable. Hence the results in figure 5 show that the grid contribution to the fault current is affected most when the generator is connected to an overhead line feeder.

2.3 Maximum generator impact

The maximum DG impact on the grid contribution to the short-circuit current occurs when the grid contribution is the minimum. Hence the minimum of equation (7) has to be determined. This is done by taken the derivative of equation (7). This leads to:

$$\frac{dI_{k,grid}}{dl} = \quad (8)$$

$$\frac{jX_g (R_L^2 - X_L(X_L - X_s) - 2l(R_L^2 - X_L^2) + j(R_L(2X_L - X_s)))}{-X_g(X_L + X_s R_L) - l^2(R_L^2 - X_L^2) + j(X_g(R_L - X_s(X_g - X_L)) + lR_L(2X_L - X_s) + 2l^2R_L X_L)^2}$$

The minimum of $I_{k,grid}$ can be found with:

$$\frac{dI_{k,grid}}{dl} = 0 \quad (9)$$

Which yields for l :

$$l = \frac{1}{2} \cdot \frac{R_L^2 - X_L(X_L - X_s) + jR_L(2X_L - X_s)}{(R_L^2 - X_L^2) - 2jX_L R_L} \quad (10)$$

With this equation the location of maximum generator impact can be calculated which can be helpful at the planning stage.

2.4 Definitions used in distribution grid protection

The goal of a protective system is to recognize certain system abnormalities which, if undetected, can lead to damage of equipment or extended loss of service (Anderson, 1999). The protective system takes corrective actions for instance isolating a faulted component of the system and restoring the rest of the grid to normal operating conditions. Two important aspects of protective systems are:

1. Reliability
2. Security

Reliability is the probability that the system will function correctly when required to act. Security is the ability of a system to refrain from unnecessary operations. The optimal protection settings are a trade-off between reliability and security. Improving the reliability of a protection scheme by applying more sensitive settings can lead to a reduction of the security of the protection scheme. These definitions will be applied throughout the chapter and it will be discussed how reliability and security is influenced when DG is integrated in the distribution grid.

3. Protection problems

Connection of small generators to distribution grids is not new at all. But in the recent past the number of small generators has been increased rapidly and the effect on distribution grid operation has become noticeable. Concerns have arisen if the distribution system including distributed generation is still protected properly. In (Mäki et al., 2004) it is stated that protection issues might become one of the biggest technical barriers for wide-scale integration of distributed generation in the Nordic distribution grids. Extensive research is done to address possible protection problems in distribution grids including distributed generation. For instance, in (Deuse et al., 2007; Doyle, 2002; Driesen & Belmans, 2006; Driesen et al., 2007; Hadjsaid et al., 1999; Kauhamieni & Kumpulainen, 2004) it is discussed that the following protection problems might appear:

- Blinding of protection
- False tripping
- Lost of fuse-recloser coordination
- Unsynchronized reclosing
- Prohibition of automatic reclosing

These problems strongly depend on the applied protective system and consequently on the type of distribution grid. Blinding of protection and false tripping are protection problems which can occur in distribution grids built of cables as well as overhead lines while fuse-recloser coordination problems and recloser problems only appear in distribution grids which (partly) consist of overhead lines. In general the mentioned protection problems can be divided into two categories:

1. Fault detection problems
2. Selectivity problems

In the next subsections all mentioned protection problems will be categorized in these two categories and will be discussed in detail. In the description the protection problems are also linked to the theoretical background.

3.1 Blinding of protection

As discussed and demonstrated in section 2 the grid contribution to the total fault current will be reduced because of the contribution of distributed generation. Due to this reduction it is possible that the short-circuit stays undetected because the grid contribution to the short-circuit current never reaches the pickup current of the feeder relay. Overcurrent relays as well as directional relays and reclosers rely their operation on detecting an abnormal current. Hence, all protective systems based on these protection devices can suffer malfunctioning because of the reduced grid contribution. This mechanism is called blinding of protection and belongs to the first category of protection problems.

In (Chilvers et al., 2004; 2005) distance protection is applied to increase the amount of distributed generation connected to the distribution grid. Distance protection is a zone protection and the protected feeder is divided into a number of zones. The first zone covers approximately 85% of the line length while zone 2 and 3 are used for the rest of the line length and as a backup protection for subsequent distance protections. Faults in zone 2 and 3 are cleared with a time delay in order to obtain selectivity with the subsequent distance protections. This protection type acts more or less independent of the size of the fault current. However, due to the reduced grid contribution the impedance calculated to the fault location will increase and causes protection underreach. Faults normally cleared in zone 1 might then be cleared in zone 2 with subsequently a longer fault clearing time. The seriousness of this problem depends on local short-circuit power, X/R ratio of the distribution feeder and size of the generator which are the key parameters mentioned in section 2.

It can be concluded that distributed generation with a relevant contribution to the fault current directly affects the sensitivity of a protective system and therefore the reliability of the protective system.

3.2 False tripping

False tripping, also known as sympathetic tripping, is possible when a generator which is installed on a feeder, contributes to the fault in an adjacent feeder connected to the same substation. The generator contribution to the fault current can exceed the pick-up level of the overcurrent protection which can lead to a trip of the healthy feeder before the actual fault is cleared. This mechanism can be categorized to the category of selectivity problems. In figure 6 the principle of false tripping is shown schematically.

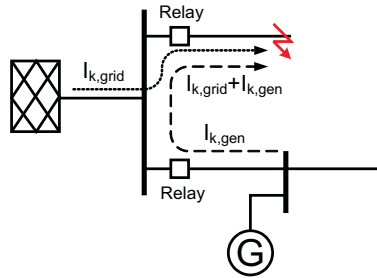

Fig. 6. Principle of false tripping

The generator has a major contribution to the fault current when the generator and/or the fault are located near the substation. Especially in weak grids with long feeder length which are protected by definite overcurrent relays false tripping can occur. In this case the settings of the protection relays have to ensure that faults at the end of the feeder are also detected which lead to a relatively small pick-up current. Here DG affects the security of the protective system.

In (Kauhaniemi & Kumpulainen, 2004) it is discussed that in some cases false tripping can be prevented by finding another suitable relay setting. Practically it means that the fault clearing time has to be increased rather than the pick-up current. Increase of the pick-up current results in a less sensitive feeder protection and probably not all faults will be cleared anymore. Hence, the security of the protective system increases, but the reliability of the protective system decreases. Changing the fault clearing time lead to the disconnection of the faulted feeder first and prevent the healthy feeder from false tripping. When selectivity cannot be reached by changing the protection settings the application of directional overcurrent protection can solve the problem (Kumpulainen & Kauhaniemi, 2004). However, directional protection is slower, more expensive and usually not the standard solution of grid operators.

3.3 Recloser problems

Protection of overhead distribution feeders with automatic reclosers is a very efficient way to protect against temporary disturbances and minimize the number of supply interruptions. Because of the coordination between the reclosers and the lateral fuses permanent faults are cleared in a selective way. Connection of DG to these type of feeders causes several protection problems at the same time. First of all the fault current detection by the recloser is affected by the generator contribution and can lead to a detection problem. Secondly the coordination between reclosers or fuse and recloser can be lost which directly causes selectivity problems. This is explained in more detail with the feeders shown in figure 7.

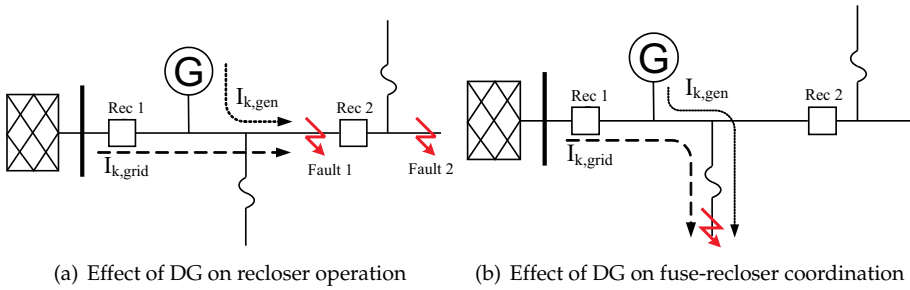

Fig. 7. Radial distribution feeder including protection devices

In figure 7(a) for the fault location *Fault 1* holds:

$$I_{k,tot} = I_{k,grid} + I_{k,gen} \tag{11}$$

For the indicated fault location *Fault 1* the short-circuit current sensed by *Rec 1* is $I_{k,grid}$. As demonstrated in section 2 the grid contribution reduces and lead to a delayed fault detection or in the worst case to no detection at all. This is an example of a fault detection problem. For fault location *Fault 2* the short-circuit current seen by *Rec 2* is $I_{k,tot}$ which is larger than the current sensed by *Rec 1*. Most reclosers are equipped with a dependent time-current characteristic and the coordination between *Rec 1* and *Rec 2* still holds. Because of the connection of the generator to the feeder the total short-circuit current is increasing and for end-of-line faults the maximum interrupting rating of *Rec 2* has to be checked.

In (Anderson, 1999) the coordination between a fuse and a recloser is explained in detail. As shown in figure 8 the fuse and recloser are coordinated such that there is selective fault clearing for the fault currents $I_{k,min} < I_{fault} < I_{k,max}$.

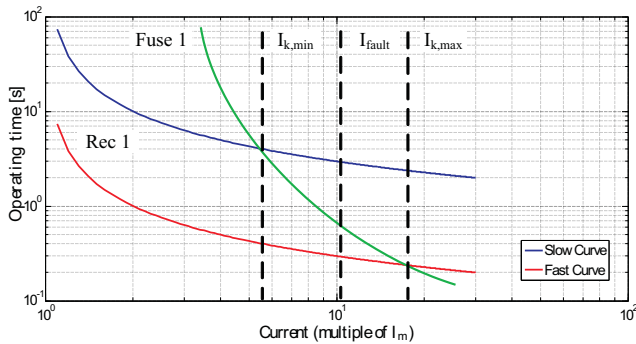

Fig. 8. Coordination between a lateral fuse and a recloser

For the situation in figure 7(b) the coordination between the fuse and recloser is lost when $I_{k,tot} > I_{k,max}$. In that case the curve of the fuse is under the curve of the recloser and the

fuse clears the fault before the recloser operates. Hence, temporary faults will be cleared permanently and lead to unnecessary interruptions.

Besides detection problems and lost of coordination DG also causes unsynchronized reclosing. During the recloser's dead time a part of the feeder is disconnected from the main system to allow the arc to deionize. The connected generator tends to keep the disconnected feeder part energized and maintains the arc at the fault-location. Hence the temporary fault becomes permanent. Moreover, due to unbalance between load and generation the generators will drift away from synchronism with respect to the main grid which results in a unsynchronized reclosing action. This can seriously damage the generator and causes high currents and voltages in neighboring grids (Kauhamieni & Kumpulainen, 2004).

4. Solutions and alternative protective systems

Installing small generation in the distribution grid has become popular since the mid eighties and the protection problems caused by DG has been studied accordingly (Dugan et al., 1984; Rizey et al., 1985). In the literature for the problems mentioned in the previous section a wide pallet of solutions is offered. These solutions vary between a simple change in relay settings to a complete new adaptive protective system. In this section an overview of possible solutions is given.

4.1 Prevention of detection and selectivity problems

Fault detection problems do have a relation with the amount of generation connected to the distribution grid and the local short-circuit power. To prevent fault detection problems a first attempt is to modify the relay settings of the relays and reclosers (Baran & El-Markabi, 2004; Hadjsaid et al., 1999; Kumpulainen et al., 2005; Mäki et al., 2004). The generator contribution leads to a reduction of the grid contribution to the fault current hence the pick-up current of the relays has to be reduced. However, fault detection problems might be solved by reducing the pick-up current, the sensitivity and security of the protective system is decreased and might lead to false tripping in case of a fault in an adjacent feeder. In (Mäki et al., 2004) an example of a weak network is given where blinding of protection occurs due to the connection of a small wind farm. By reducing the pick-up current blinding of protection is solved but at the same time it introduces for faults in a certain area false tripping. A proposed solution is to install protection devices with an additional time delay to give the feeder including the wind farm a longer fault clearing time. These type of solutions also discussed in (Deuse et al., 2007). Another example of changed protection settings is discussed in (Baran & El-Markabi, 2004). Here an adaptive overcurrent relay is proposed which decreases the pick-up current as the output of the local generation increases. This is also studied in (Vermeyen, 2008) where it is stated that a continuous adaptation of the pick-up current as function of the generator output results in less superfluous disconnection of the feeder.

4.2 Mitigation of recloser problems

Fault detection problems also occur in distribution feeders with overhead lines including DG, which are protected by reclosers. As a result fuse-recloser coordination can be lost. In (Brahma & Girgis, 2002) modern microprocessor-based reclosers are applied to restore the coordination between the fuse and recloser. In the microprocessor several trip curves can be programmed and the microprocessor keeps track which curve is in use. As explained in figure 8 the recloser is equipped with a fast and a slow curve. In the microprocessor the fast curve should be programmed in such a way that this curve is selective with the lateral fuses, especially in

presence of DG. To prevent unsynchronized reclosing, DG has to be disconnected as soon as possible which brings the grid back in the situation without DG. Hence, the fast curve has to be active only during the first reclosing action. In the second reclosing cycle, the slow curve is active which is selective with the lateral fuses and the fault can be cleared in a selective way. A different approach to solve the fuse-recloser problem is to limit the infeed of the DG. Therefore for laterals where DG is connected onto, the protective scheme is modified by replacing the lateral fuse for a high speed recloser (Funmilayo & Butter-Purry, 2009). The reclosers are coordinated in such a way that the lateral recloser operates before the recloser in the main feeder. Furthermore at the coupling point the DG-unit is equipped with an overcurrent relay. The modifications are shown in figure 9.

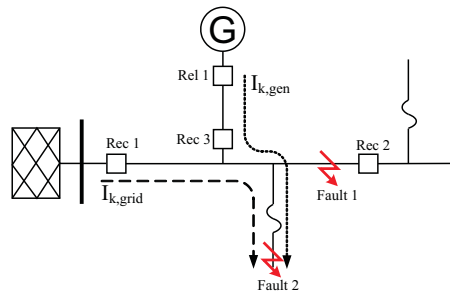

Fig. 9. Modified protective scheme for a radial feeder protected by a recloser

For fault location *Fault 1* the recloser *Rec 1* operates on the fast curve and clears the fault. The lateral recloser *Rec 3* also operate at his fast curve and limits the infeed of the DG-unit. Both reclosers are high-speed reclosers and the main feeder as well as the lateral are reconnected after a short time period. When it concerns a temporary fault the feeder can stay in operation. For a permanent fault, after the reclosing action of both reclosers, the overcurrent relay *Rel 1* of the DG-unit disconnects the DG-unit. This occurs before the delayed operation of recloser *Rec 1*. Since the DG-unit is removed from the system, the fault clearing can proceed as it normally does for distribution grids without DG. For fault location *Fault 2* a lateral recloser *Rec 3* and the main feeder recloser *Rec 1* clear the fault. In case of a permanent fault the reclosing action of both reclosers will again lead to a fault current which will blow the fuse. Now the fault is removed and the feeder can stay in operation. When the fuse fails to clear the fault the overcurrent relay *Rel 1* will disconnect the DG-units and the recloser at the main feeder will lock-out after one or two delayed reclosing attempts.

The idea of the previous solution is to limit the DG infeed and restore the radial nature of the distribution grid. The most effective way solving all protection problems is a fast disconnection of all involved DG during a disturbance. In some connection standards, e.g. (IEEE1547, July, 2003), this is even obliged. As discussed in (Tailor & Osman, 2008) the disconnection of the DG-units has to take place before the fuses or reclosers can operate. For this purpose a regular circuit breaker is relatively slow and it is proposed to replace the mechanical circuit breaker by a semiconductor switch. The semiconductor switch contains two anti-parallel connected Gate Turn Off (GTO) thyristors and a current sensing unit with a microprocessor. The current sensing unit is set with a preset value and monitors continuously the DG phase currents. If the threshold is exceeded it indicates that a fault has occurred and the current sensing

unit is sending blocking signals to the GTOs. Within a few milliseconds the DG-units are removed from the distribution grid and the radial nature is restored before a fuse or recloser has operated.

4.3 Strategies for solving unsynchronized reclosing and islanding

The most challenging protection problem is unsynchronized reclosing and islanding. Unsynchronized reclosing only occurs in distribution grids protected by reclosers while islanding can occur in grids with a conventional overcurrent protection as well. Unsynchronized reclosing is already discussed in section 3.3. The islanding problem has a strong relation with unsynchronized reclosing. During the reclosers dead-time, a DG-unit can be still connected to the isolated part of the feeder. The DG-unit tends to feed the local connected load and the isolated part can be considered in island operation. In case of a large unbalance between load and generation the speed of the generator will in- or decrease and the voltage and frequency will exceed the allowable tolerances mentioned in the standards. Because of the violation of these tolerances the DG-unit will be disconnected by its own voltage or frequency protection. This action should take place before the reclosing action to prevent unsynchronized reclosing. The most effective solution to prevent islanding and subsequently unsynchronized reclosing is the disconnection of the DG-unit before the reclosing action takes place. The challenge in here is to detect the formed island fast enough. Island detection methods can be divided into three categories (Abarrategui et al., 2007; Mahat et al., 2008):

1. Passive methods
2. Active methods
3. Traditional methods or remote techniques

The passive methods make use that when an island is formed some important parameters, such as voltage, current, frequency and harmonic distortion, changes. Monitoring the change of these parameters can lead to a detection of an island. The difficulty of these methods is defining suitable threshold values to differentiate islanding from other disturbances. An example of a popular passive islanding protection is the rate of change of frequency (ROCOF). For systems with a load or generation surplus the ROCOF protection works well. However, in a perfect match of generation and load the rate of change of frequency is small and island detection will be quite cumbersome.

Active islanding detection methods intentional create a small disturbance in the system which results in a significant change in system parameters in an islanded situation. In case the feeder is connected to the main grid the effect of these small disturbances are hardly noticeable. An example of a intentional disturbance is an introduction of a voltage fluctuation applied through a small change of the AVR of the DG-unit. For an islanded feeder the effect of the AVR is much larger than for feeders which are connected to the main system. The active methods are able to detect an island even when the load matches still the generation however, setting up an intentional disturbance needs some time and therefore these methods are slower than the passive methods.

Traditional methods or remote techniques are based on communication between the utility and the DG-unit. In the substation the position of the circuit breakers which can cause the island are monitored and when one or more of these circuit breakers opens a transfer trip signal is sent to the DG-unit. For the monitoring system a Supervisory Control and Data Acquisition

(SCADA) system can be used. For the transmission of the trip signal a dedicated communication channel has to be present which is often expensive to implement and hence uneconomical. The investment in communication channels can be prevented by using power-line carrier (PLC) communication (Benato et al., 2003; Ropp et al., 2000). This islanding detection system uses a ripple control signal which is superimposed on the medium voltage. The signal is detected via a sensor which is located at the DG-site. Opening the circuit breaker not only interrupts the load current but also the ripple control signal. The loss of the signal is sensed by the sensor and subsequently the DG-unit is disconnected. In (Kumpulainen et al., 2005) the PLC transfer trip method is considered reliable and selective. However, further studies as well as field tests are needed to verify the feasibility of the method. Efficient and reliable islanding protection methods are necessary to remove barriers which nowadays limits the integration of DG in distribution grids.

4.4 Developments in protective systems

As discussed in the previous sections integrating DG in distribution grids can lead to serious protection problems. Now the tendency is, in case of a grid disturbance, to disconnect the DG as soon as possible in order to restore the original nature of the distribution grid. Restoring the original nature of distribution grids results in a unidirectional fault current and the traditional protective system has proven its capability to clear the fault in a selective way. For remote faults disconnection of DG is, however, not always necessary and a waste of useable energy. Recent developments in protective systems are focused on adaptive protection schemes which can distinguish grid disturbances in distribution grids including DG. The papers written on these developments are numerous and some interesting and promising results are reported in (Brahma & Girgis, 2004; Perera & Rajapakse, 2006; Perera et al., October 2008). Traditional protective systems make use of locally measured quantities and react if one of these quantities is violating a certain threshold while new adaptive protective systems rely on information obtained by specific measurement systems. The protective strategy divides the distribution grid of a certain area into zones rather than protecting a single component or feeder. An example of this strategy is given in (Brahma & Girgis, 2004) where the distribution grid is split into zones which are able to run in island operation. The protective system is based on a centralized computer wherein the grid topology is programmed. Via communication channels all actual breaker positions are known. The computer executes off-line load flow and short-circuit current calculations and stores the results in a database. Topology changes due to switching actions will update the tables in the database. The central computer uses synchronized current vector measurements at the main source, distributed generators and breakers. In case of a fault these measurements are compared with the values in the database to identify the faulted section or zone. A trip signal is sent to the breakers which interconnect the various zones and the faulted zone is isolated. The remaining zones return to normal operation and in the faulted zone the fault is cleared. A drawback of this system is its heavy dependence on a centralized processing system and the communication links between the zones.

In (Perera & Rajapakse, 2006; Perera et al., October 2008) an agent-based protective system is discussed which overcomes the drawback of the previous system. This protective system also splits up the distribution grid into zones and exchanges data for these zones via communication links. The agents are located at strategic locations and make use of local current measurements. Via a wavelet transformation the current signal is processed and the fault direction is determined. All agents are equipped with a fault locating algorithm and with the

aid of the data exchange between the agents and the fault locating algorithm the faulted zone is cleared. It is demonstrated that this protective system also works for high impedance faults and for distribution grids including DG.

Adding communication links to existing distribution grids is costly and hardly justified in comparison with the benefits of improving the availability of DG. However, the need for more data for accurate grid operation, smart metering and introduction of micro grids and virtual power plants, also asks for communication links. The installation of communication channels can become attractive when these links are shared by these processes. In this way new developments become possible which are hardly feasible when each individual development is justified by its own.

5. Case study on a benchmark network

In this section the fault detection and selectivity problems are evaluated with the aid of a generic benchmark network. First, the fault detection problem is studied with static calculations while the effect of the generator dynamics on the performance of the protective system is examined with dynamic simulations. In the case study it will be demonstrated how the protective system can be modified to mitigate and prevent fault detection problems.

5.1 Test system topology

In (Strunz, 2009) benchmark systems for network integration of distributed generation including all grid parameters and a reference load flow are provided. A distinction is made between benchmark networks which are common in North America and benchmark networks which are typical for Europe. In this chapter the European medium voltage benchmark network is used for which the single line diagram is depicted in figure 10. All network data is given in (Strunz, 2009). The topology of the benchmark network consists of the feeder systems Feeder 1 and Feeder 2 which are indicated in the dashed boxes. Both feeders are operated at 10 kV and are fed via separate transformers from the 110 kV transmission system. The configuration of the network can be modified by means of the switches S1, S2 and S3. Via these coupling switches radial, ring and meshed operation of the benchmark network is possible.

5.2 Fault detection problems

The theory of fault currents in faulted distribution feeders including DG is discussed in section 2. In this case study the effect of DG on the fault currents of Feeder 2 of the benchmark network is examined to determine if fault detection problems appear. On Feeder 2 the same approach as in section 2.2 is applied to illustrate what effect the connection of a synchronous generator has on the grid contribution to the short-circuit current. This is done for different generator sizes in the range of 2-10 MVA. Via repetitive calculations the size and location of the generator is varied. For Feeder 2 the grid contribution as function of the generator size and location is given in figure 11.

The shape of the curves in figure 11 shows a great similarity with the curves in figure 5. The minima of these curves indicate the location of the largest generator impact. With the aid of the parameters of Feeder 2 and knowing the grid impedance this location can be calculated with equation (10). The local fault level of Node 12 is 180 MVA which corresponds with a grid impedance of $j0,551 \Omega$. The electric parameters of Feeder 2 are given in table 2.

According to table 2 the total feeder impedance Z_L , is $5,04 + j3,57 \Omega$. With the aid of the grid and feeder impedance and equation (10) the relative worst case generator location can be obtained. The relative worst case generator location l , is calculated as 0,43. The total feeder

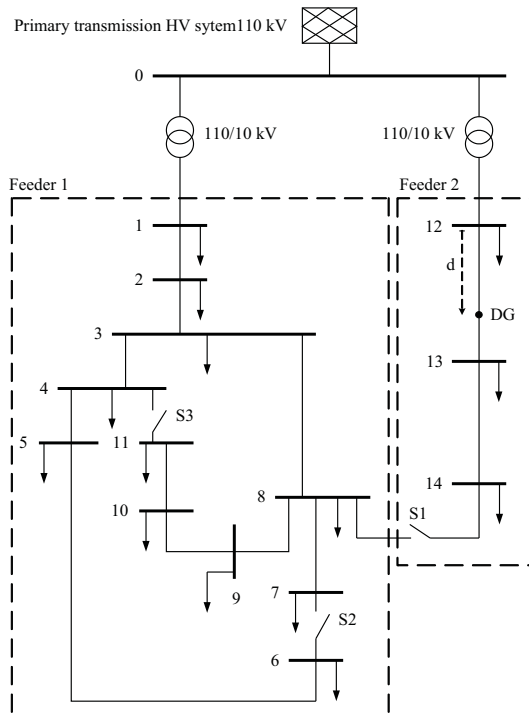

Fig. 10. Medium voltage benchmark network

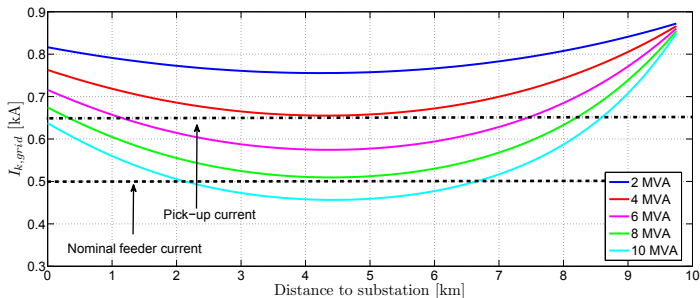

Fig. 11. Grid contribution as function of generator size and location

length d_{tot} is 9,88 km and with equation (1) the worst case generator location is 4,42 km which corresponds with the minima shown in figure 11.

Normally for benchmark networks the data of the protective system is not provided. Feeder 2 of the benchmark network is supposed here to be protected with a definite overcurrent protection which is located in Node 12. In (Anderson, 1999) general setting rules for overcurrent

Line	R [Ω/km]	X [Ω/km]	d_{Line} [km]	Z_{tot} [Ω]	I_{nom} [A]
Line 12-13	0,51	0,361	4,89	$2,49 + j1,77$	500
Line 13-14	0,51	0,361	2,99	$1,52 + j1,08$	500
Line 14-8	0,51	0,361	2	$1,02 + j0,72$	500

Table 2. Line parameters of Feeder 2 of the benchmark network

protection are proposed. For instance, for the pick-up current I_m an approach of $I_m = 2 \cdot I_{nom}$ is proposed. Applying these rules on Feeder 2 do not lead to satisfactory relay settings. Due to the relative high feeder impedance the fault currents are such that $2 \cdot I_{nom}$ will not be reached. Therefore the pick-up current of the protection is set to $1,3 \cdot I_{nom}$ with a reaction time of 0,3 s. The pick-up current of the protection and the nominal feeder current is projected in figure 11. This figure indicates that for generators larger than 4 MVA the grid contribution declines under the pick-up current and causes blinding of protection. Strictly speaking generators larger than 4 MVA cannot be connected to Feeder 2 for locations where the grid contribution is smaller than the pick-up current. Connection of this size of generators is only possible when the protective system is modified and it is guaranteed that all possible faults can be detected. In (Deuse et al., 2007; Mäki et al., 2004) reduction of the pick-up current is proposed which makes the protective system more sensitive. For Feeder 2 reduction of the pick-up current reduces the reliability of the protection because the pick-up current approximates the nominal feeder current. In that case small switching transients can cause unwanted disconnection of the feeder.

For a more detailed analysis of the effect of DG on the protective system of Feeder 2, the DG-location is set at the worst case generator location. This is indicated in figure 10 with the parameter d . For a fixed DG-location the zone wherein fault detection problems occur, can be determined by calculating the grid contribution for all fault locations along Feeder 2. Per line segment for various fault locations a three-phase short-circuit calculation is performed. The fault location is adjusted with 1% of the length of the line segment. The results of these calculations are, including the pick-up current of the protection, depicted in figures 12(a) and 12(b). For a generator of 6 MVA the non-detection zone starts for faults at a distance $d_{Fault} > 9 km$ while for a 10 MVA generator this zone already starts at $d_{Fault} > 8 km$. In figure 12(b) it can be seen that for the mentioned zones the fault current will not be detected.

5.3 Dynamic simulations of fault detection problems

The calculations carried out so far do not incorporate the dynamics of the synchronous generator. As discussed in many textbooks (Grainger & Stevenson, 1994; Kundur, 1993; Machowski et al., 2008) the synchronous generator injects a time-varying short-circuit current which results in a time-varying grid contribution as well. Via dynamic simulations Feeder 2 is examined to determine how the protective system copes with the time-varying grid contribution. Therefore a three-phase fault at the end of Feeder 2 is simulated for generator sizes in the range of 2-10 MVA. The resulting grid contributions are given in figure 13.

The first conclusion that can be drawn from the simulations is that the fault stays undetected when the generator size is larger than 8 MVA. During the complete simulation period the grid contribution stays below the pick-up current of the overcurrent protection. The dynamic effect of the generator manifests itself in the increasing grid contribution to the fault current. This is mainly caused by the decaying DC-component in the generator contribution to the fault

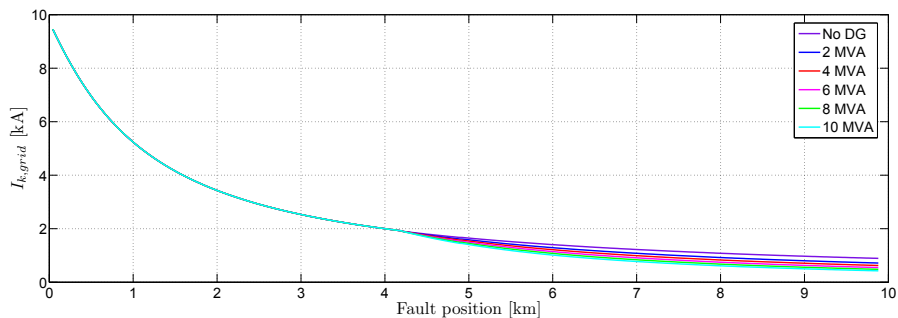

(a) Grid contribution for various fault locations in Feeder 2

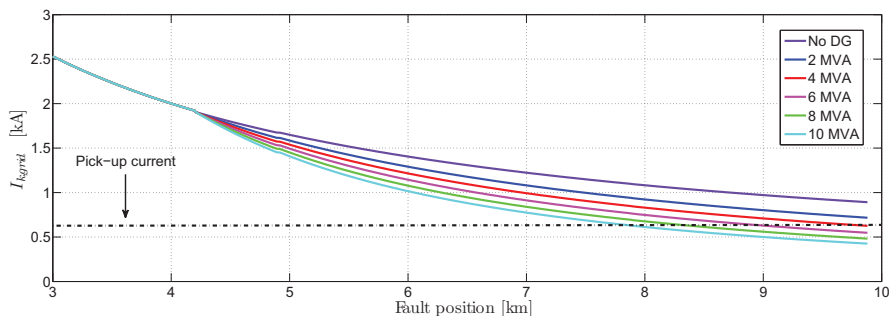

(b) Detail of figure 12(a)

(b) Detail of figure 12(a)

Fig. 12. Grid contribution as function of the fault location in Feeder 2

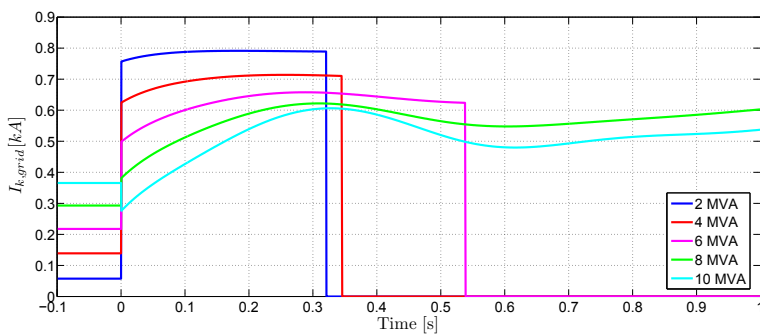

Fig. 13. Dynamic simulation of a three-phase fault at the end of Feeder 2 for various generator sizes

current. Initially the overcurrent protection is not triggered but after the DC-component is sufficiently damped for generator sizes smaller than 6 MVA the pick-up current is exceeded and the fault is cleared. However, for the case a 6 MVA generator is connected, the fault clearing is delayed with approximately 250 ms. This can cause serious coordination problems with upstream protective systems. A detailed look at the results in figure 13 shows that even connecting a 4 MVA generator leads to a delayed fault clearing.

Because of selectivity reasons and possible extra equipment damage, delayed fault clearing is unacceptable. Making in such situations the integration of DG possible then the protection settings or protective system has to be modified. The relatively weak feeder does not allow a reduction of the pick-up current of the overcurrent protection without the risk of unnecessary tripping of a healthy feeder.

The protection which has not been taken into account so far is the interconnect protection of the DG-unit itself. This type of protective system can affect the operation of the grid protection. Examples of interconnect protection relays are under- and overvoltage and under- and overfrequency protection. Interconnect protection differs from generator protection. The goal of generator protection is to protect the generator against internal short-circuits and abnormal operating conditions. These protection devices are connected at the terminals of the generator while the interconnect protection is connected at the point of common coupling (PCC). The major functions of an interconnect protection are (Mozina, 2006):

1. Disconnection of DG when it is no longer operating in parallel with the distribution grid
2. Protection of the grid system from damage caused by the connection of DG
3. Protection of the generator from damage from the grid system (e.g. auto reclosing)

The simulation model used in this section is extended with an interconnect protection of the DG-unit. The generator is equipped with a voltage transformer which measures the voltage of the PCC and an undervoltage protection. The settings of the undervoltage protection are a pick-up value of 0.8 p.u. and a clearing time of 200 ms. The pick-up time of the undervoltage protection is set at 20 ms. With the interconnect protection model the dynamic simulations are repeated to determine if the interconnect protection has a positive contribution to the fault detection problems. The results of the simulations are depicted in figure 14(a) and 14(b).

In figure 14(a) for generator sizes up to 6 MVA it can be seen that after 200 ms the generator is switched off by the undervoltage protection. After disconnecting the generator the grid contribution increases directly. For the generator sizes of 2 and 4 MVA the overcurrent protection was already triggered hence the fault-clearing time does not differ with the previous results. The disconnection of the 6 MVA generator results in an increase of the grid contribution in such a way that the pick-up current of the overcurrent relay is exceeded and the fault is cleared. However, the total fault clearing time is still approximately 550 ms. For these cases the undervoltage protection of the generator does not speed up the fault-clearing time of the protective system. For the generator sizes of 8 and 10 MVA the results significantly differ. In the previous simulations blinding of protection occurred and the overcurrent protection did not clear the fault. The addition of the undervoltage protection leads to the disconnection of the generator with the result that the overcurrent protection is triggered and the fault is cleared. However, the fault-clearing time is respectively 570 and 650 ms. These results can be explained in more detail with the aid of figure 14(b) where for all simulated generator sizes the voltage at the PCC is given. At the moment the fault occurs the voltage along the feeder

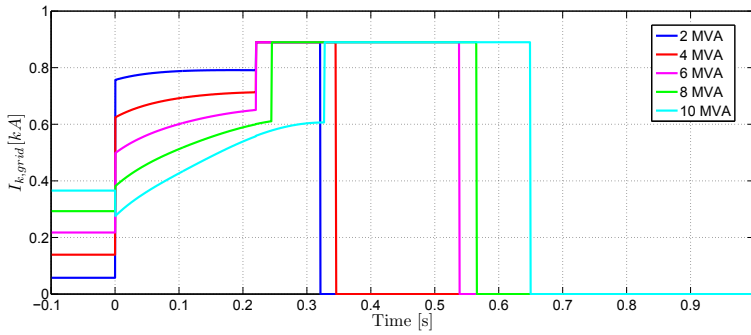

(a) Grid contribution to the fault current

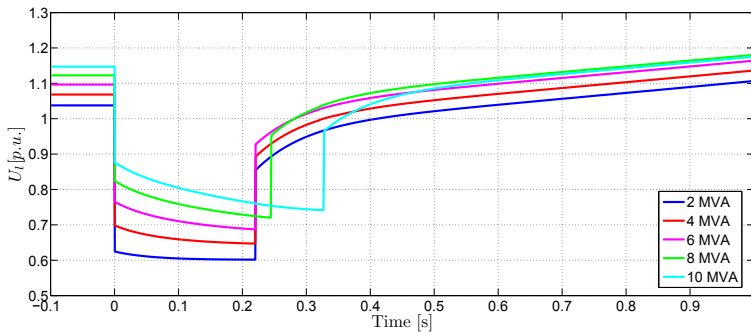

(b) Measured voltage by the undervoltage protection at the point of common coupling

Fig. 14. Dynamic simulation of a three-phase fault for various generator sizes including undervoltage protection

drops. In all simulations the generator tends to keep up the voltage at the PCC. For large generators this effect is stronger than for small generators. As discussed earlier the contribution of the generator consist of a decaying DC-component. Because of this declining DC-component the voltage at the PCC starts to drop as well, as can be seen in figure 14(b). For the cases till 6 MVA the voltage at the PCC drops below the pick-up value of the undervoltage protection immediately after the fault is applied. The 8 and 10 MVA generator keep up the voltage above the pick-up level of the undervoltage protection hence the undervoltage protection is not triggered. At a certain moment the voltage at the PCC exceeds the pick-up value of the undervoltage protection and the generator is disconnected from the feeder. This results directly in an increase of the grid contribution which triggers the overcurrent protection and removes the fault from the feeder. It can be concluded that the addition of the interconnect protection leads to fault clearing for all simulated cases. However, for larger generator sizes the fault clearing time is unacceptable.

To reduce the fault-clearing time the protective system has to be modified. The main goal of this modification is a guaranteed fault detection and a reduction of fault-clearing time. Gen-

erally, integration of a generator in a distribution grid increases the total fault current which can be used to improve the performance of the protective system. For faults after the PCC of the generator an overcurrent protection would sense the sum of the grid and generator contribution while the first upstream protection device before the PCC only senses the grid contribution. The difference in sensed fault currents can be used for coordinating the protection devices and reducing the fault-clearing time (Jäger et al., 2004; Keil & Jäger, January 2008). Therefore in Node 13 an overcurrent protection is modeled and coordinated with the overcurrent protection of Node 12. In figure 15 an overview of the location of all protection devices of Feeder 2 of the benchmark network is given.

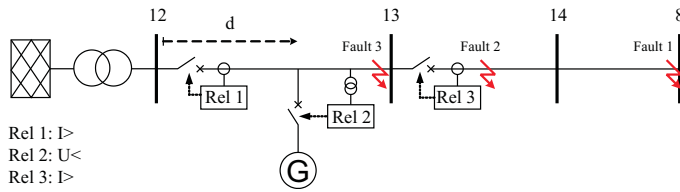

Fig. 15. Overview of all protection devices of Feeder 2

The protection devices Rel 1 and Rel 3 are coordinated such that faults between Node 13 and Node 8 are cleared by Rel 3 and faults between Node 12 and Node 13 by Rel 1. Protection device Rel 1 also serves as a backup protection for faults between Node 13 and Node 8 which are, for whatever reasons, not cleared by Rel 3. The relay settings are determined without the generator contribution. Hence the feeder protection operation is independent of the presence of the generator. In figure 18 the coordination of Rel 1 and Rel 3 is shown. In this case study a time grading of 200 ms is used.

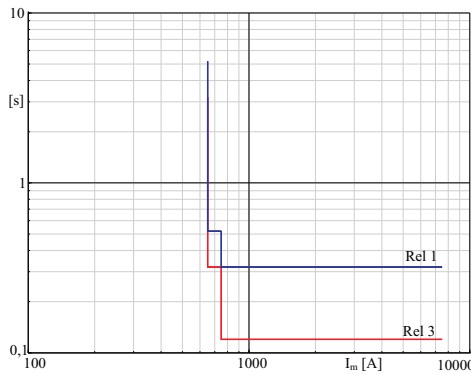
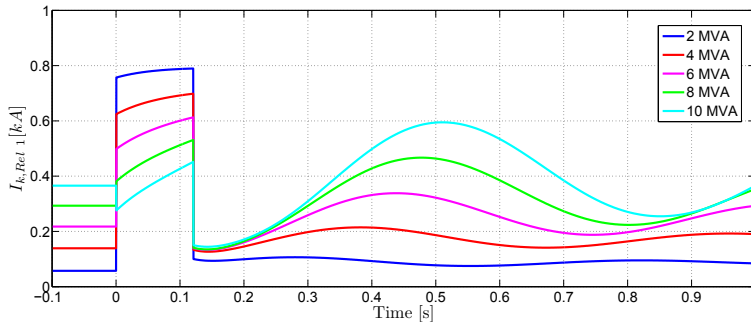

Fig. 16. Protection coordination graph of Feeder 2

The modified protection scheme is tested for three fault locations as indicated in figure 15. Fault location *Fault 1* is located at the end of Feeder 2 to check if Rel 3 can detect the fault current. Fault location *Fault 2* is near to Node 13 to determine selective fault clearing between

Rel 1 and Rel 3. The third fault location *Fault 3* is chosen just before Node 13 to study if the grid contribution to the fault current is large enough to trigger Rel 1. For these fault locations similar dynamic simulations as in the previous situations are performed. The results of the first fault location are depicted in figure 17. In this figure the sensed fault currents by Rel 1 and 3 are given. It can be seen that for all generator sizes relay Rel 3 clears the fault in 100 ms. Relay Rel 1 does not react on the grid contribution to the fault current and the generator stays connected to the network. After fault-clearing the current swing sensed by Rel 1, as shown in 17(a) is caused by the dynamics of the generator.



(a) Fault current at location Rel 1 for fault location 1

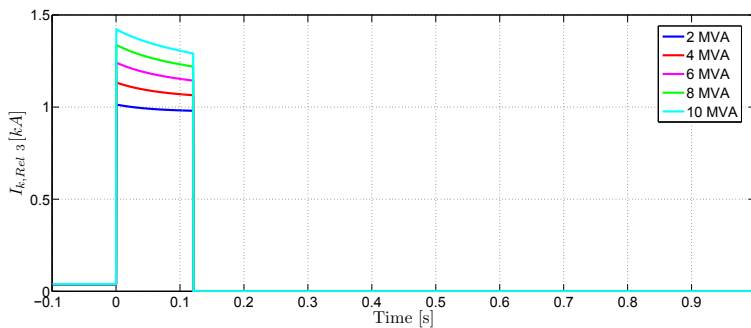

(b) Fault current at location Rel 3 for fault location 1

Fig. 17. Fault currents at relay location Rel 1 and Rel 3 for fault location 1

For fault location *Fault 2* the simulations indicate that this fault is also cleared in 100 ms by Rel 3. This is given in figure 18. The grid contribution is such that Rel 1 is triggered as well but the fault is cleared in a selective way. Because the fault is cleared in 100 ms the generator stays connected to the grid.

The results for the third fault location differ from the previous results. The clearing time of relay Rel 1 is set to 300 ms hence during the fault the generator is disconnected by the under-voltage protection. This can be seen in figure 19 which shows the results of the simulation of this fault location. In the first 200 ms of the fault the grid contribution is sufficient to trigger

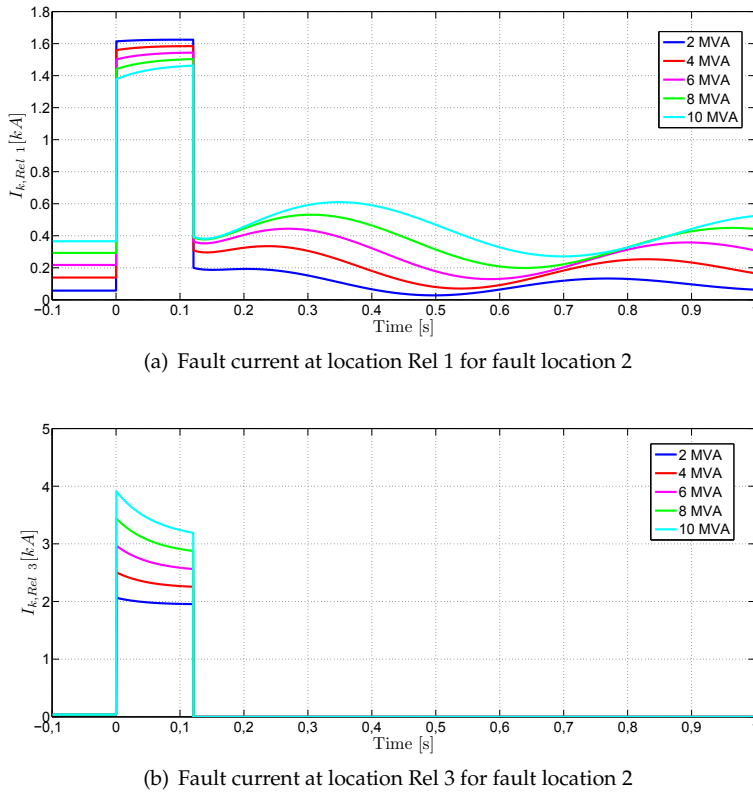

Fig. 18. Fault currents at relay location Rel 1 and Rel 3 for fault location 2

the overcurrent protection. For all generator sizes the generator is disconnected after 200 ms which causes a sudden increase in the grid contribution to the fault current. However, the overcurrent protection was triggered already and the fault is cleared after 300 ms.

It can be concluded that the addition of relay Rel 3 has resulted in a faster fault clearing for faults between Node 13 and Node 8 without disconnection of the generator. It is demonstrated that Feeder 2 is protected in a selective way. Faults between Node 12 and Node 13 are switched-off in 300 ms for all generator sizes. In comparison with the previous results the modification of the protective system has led to a reduction in fault clearing time of 350 ms. Simulations have shown that all faults are cleared within 300 ms.

6. Conclusions

In this chapter the effect of distributed generation on the protection of distribution grids was treated. It was demonstrated that DG-units with a synchronous generator can have a strong influence on the grid contribution to the fault current. Analytical expressions were derived to

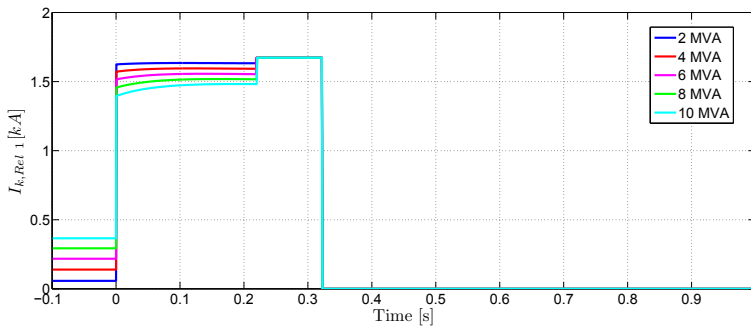

Fig. 19. Fault current at location Rel 1 for fault location 3

determine the key parameters which influence the grid contribution to the fault current. Important parameters which determine the effect of the generator on the grid contribution to the fault current are the total feeder impedance, the size and the location of the generator. Besides that, the local short-circuit power is also of importance. In a simulation of a 3-bus network it was shown that the generator has more effect on the grid contribution to the fault current for feeders consisting of overhead lines than for the same type of feeder built up of cables. This effect is caused by the fact that overhead lines have a significant larger impedance than an equivalent cable. Based on the results of the 3-bus network and the analytical description of the grid contribution to the fault current an equation was derived which can be used to calculate the worst-case generator location.

Then, an overview of all possible protection problems was given and categorized into fault detection and selectivity problems. This categorization shows that apparent different protection problems, such as blinding of protection and lost of fuse-recloser coordination, are related to each other. It was pointed out that solving the fault detection problem directly influence the reliability of a protective system while solving selectivity problems affect the security of a protective system. For both types of protection failure various solutions were discussed and an overview of new developments in protective systems to prevent these protection problems has been given.

The fault detection problem was demonstrated with a generic test feeder. The derived equations were applied on the test feeder to calculate the worst-case generator location. Stationary simulations were carried out for generator sizes of 2-10 MVA and showed that fault detection problems are expected for generator sizes > 4 MVA. Dynamic simulations gave a more accurate results and it could be concluded that for generator sizes of 8-10 MVA serious fault detection problems may occur while for generator sizes of 2-6 MVA a delayed fault clearing takes place. The different result can be explained by noticing that in the dynamic simulation the DC-component in the fault current of the generator is damped. Because of the declining generator contribution the grid contribution increases and triggers the overcurrent protection. Normally the DG-units are equipped with an undervoltage protection and with that the series of simulations were repeated. It resulted in guaranteed fault clearing for all generator sizes, however, for some sizes the fault clearing was still delayed. Hence, to improve the performance of the protective system it has to be modified. A simple modification is the addition of a protection device after the PCC of the generator which has to be coordinated with the

upstream protection device. This modified protective system was simulated and resulted for all generator sizes in a guaranteed and selective fault clearing. In general the case study showed that dynamic simulations are necessary to evaluate the performance of a protective system of a feeder including DG.

7. References

- Abarrategui, O., Zamora, I. & Larruskain, D. (2007). Comparative analysis of islanding detection methods in networks with DG, *CIREC 19th International conference on Electricity Distribution, May 21-24, Vienna*.
- Anderson, P. (1999). *Power System Protection*, IEEE Press power engineering series, McGraw-Hill, New York.
- Baran, M. & El-Markabi, I. (2004). Adaptive overcurrent protection for distribution feeder with distributed generation, october 10-13, new york ny, *IEEE Power Systems Conference and Exposition*, Vol. 2, pp. 715–719.
- Baran, M. & El-Markabi, I. (2005). Fault analysis on distribution feeders with distributed generation, *IEEE transactions on power systems*, Vol. 20, pp. 1757–1764.
- Benato, R., Caldon, R. & Cesena, F. (2003). Carrier signal-based protection to prevent dispersed generation islanding on mv systems, *CIREC 17th International conference on Electricity Distribution, May 12-15, Barcelona*.
- Brahma, S. & Girgis, A. (2002). Microprocessor-based reclosing to coordinate fuse and recloser in a system with high penetration of distributed generation, *IEEE Power Engineering Society Winter Meeting, New York NY*, pp. 453–458.
- Brahma, S. & Girgis, A. (2004). Development of adaptive protection scheme for distribution systems with high penetration of distributed generation, *IEEE Transactions On Power Delivery*, Vol. 19, pp. 56–63.
- Chilvers, I., Jenkins, N. & Crossley, P. (2004). The use of 11 kV distance protection to increase generation connected to the distribution network, *Eight IEE international conference on developments in power system protection, Amsterdam, the Netherlands*.
- Chilvers, I., Jenkins, N. & Crossley, P. (2005). Distance relaying of 11 kV circuits to increase the installed capacity of distributed generation, *IEE Proceedings Generation, Transmission and distribution*, Vol. 152, pp. 40–46.
- Deuse, J., Grenard, S., Bollen, M., Häger, M. & Sollerkvist, F. (2007). Effective impact of der on distribution system protection, *CIREC 19th International conference on Electricity Distribution, May 21-24, Vienna*.
- Doyle, M. (2002). Reviewing the impact of distributed generation on distribution system protection, *IEEE Power Engineering Society Summer Meeting, Chicago IL*.
- Driesen, J. & Belmans, R. (2006). Distributed Generation: Challenges and possible solutions, *IEEE Power Engineering Society General Meeting, Tampa FL*.
- Driesen, J., Vermeyen, P. & Belmans, R. (2007). Protection issues in microgrids with multiple distributed generation units, *Power Conversion Conference PCC'07, Nagoya*.
- Dugan, R., Thomas, S. & Rizy, D. (1984). Integrating dispersed storage and generation with an automated distribution system, *IEEE transactions on power apparatus and systems*, Vol. PAS 103, pp. 1142–1146.
- Funmilayo, H. & Butter-Purry, K. (2009). An approach to mitigate the impact of distributed generation on the overcurrent protection scheme for radial feeders, *IEEE Power Systems Conference and Exposition, Seattle WA*, pp. 1–11.
- Grainger, J. & Stevenson, W. (1994). *Power System Analysis*, McGraw Hill Inc.

- Hadjsaid, N., Canard, J.-F. & Dumas, F. (1999). Dispersed generation impact on distribution networks, *Computer applications in power*, Vol. 12, pp. 22–28.
- IEEE1547, S. (July, 2003). IEEE 1547 standard for interconnecting distributed resources with electrical power systems, IEEE.
- Jäger, J., Keil, T., L. Shang & Krebs, R. (2004). New protection co-ordination methods in the presence of distributed generation, *Eight IEE international conference on developments in power system protection, Amsterdam, the Netherlands*, pp. 319–322.
- Jenkins, N., Allen, R., Crossley, P., Kirschen, D. & Strbac, G. (2000). *Embedded Generation*, Series 31, 2nd edn, IEE Power & Energy, London.
- Kauhamieni, K. & Kumpulainen, L. (2004). Impact of distributed generation on the protection of distribution networks, *Eight IEE international conference on developments in power system protection, Amsterdam, the Netherlands*, Vol. 1, pp. 315–318.
- Keil, T. & Jäger, J. (January 2008). Advanced coordination method for overcurrent protection relays using nonstandard tripping characteristics, *IEEE transactions on power delivery*, Vol. 23, pp. 52–57.
- Kumpulainen, L. & Kauhaniemi, K. (2004). Analysis of the impact of distributed generation on automatic reclosing, *IEEE Power Systems Conference and Exposition, October 10-13, New York NY*, Vol. 1, pp. 603–608.
- Kumpulainen, L., Kauhaniemi, K., Verho, P. & Vähämäki, O. (2005). New requirements for system protection caused by distributed generation, *CIGRE 18th International Conference on Electricity Distribution, June 6-9, Turin*.
- Kundur, P. (1993). *Power system Stability and Control*, McGraw Hill Inc., New York, USA.
- Machowski, J., Bialek, J. & Bumby, J. (2008). *Power System Dynamics, Stability and Control*, 2nd edn, John Wiley & Sons, Chichester, United Kingdom.
- Mahat, P., Chen, Z. & Bak-Jensen, B. (2008). Review of islanding detection methods for distributed generation, *Third international conference on Electric Utility Deregulation Restructuring and Power Technologies (DRPT2008), April 2008, Nanjing, China*, pp. 2743–2748.
- Mäki, K., Repo, S. & Järventausta, P. (2004). Effect of wind power based distributed generation on protection of distribution networks, *Eight IEE international conference on developments in power system protection, Amsterdam, the Netherlands*, Vol. 1, pp. 327–330.
- Morren, J. & de Haan, S. (2008). Impact of distributed generation units with power electronic converters on distribution network protection, *Ninth IET international conference on developments in power system protection, Glasgow, Scotland*.
- Mozina, C. (2006). Distributed generator interconnect protection practices, *IEEE Power Engineering Society Power System Conference and Exposition, Dallas TX*, pp. 1164–1170.
- Perera, N. & Rajapakse, A. (2006). Agent-based protection scheme for distribution networks with distributed generation, *IEEE Power Engineering Society General Meeting, Montreal, QC, Canada*.
- Perera, N., Rajapakse, A. & Buchholzer, T. (October 2008). Isolation of faults in distribution networks with distributed generators, *IEEE transactions on power delivery*, Vol. 23, pp. 2347–2355.
- Rizy, D., Jewell, W. & Stovall, J. (1985). Operational and design considerations for electric distribution systems with dispersed storage and generation, *IEEE transactions on power apparatus and systems*, Vol. PAS 104, pp. 2864–2871.

- Ropp, M., Aaker, K., Haigh, J. & Sabbah, N. (2000). Using power line carrier communication to prevent islanding, *Twenty-eight IEEE Photovoltaic Specialists Conference, Anchorage, AK*, pp. 1675–1678.
- Strunz, K. (2009). Benchmark systems for network integration of renewable and distributed energy resources, *Preliminary version, Cigre Task Force C6.04.02, July 2009*.
- Taylor, J. & Osman, A. (2008). Restoration of fuse-recloser coordination in distribution system with high dg penetration, *IEEE Power Engineering Society General Meeting, Pittsburg PA*.
- Vermeyen, P. (2008). *Effect of distributed generation on fault detection and ripple control*, Ph.D Thesis, Katholieke Universiteit Leuven.



Distributed Generation

Edited by D N Gaonkar

ISBN 978-953-307-046-9

Hard cover, 406 pages

Publisher InTech

Published online 01, February, 2010

Published in print edition February, 2010

In the recent years the electrical power utilities have undergone rapid restructuring process worldwide. Indeed, with deregulation, advancement in technologies and concern about the environmental impacts, competition is particularly fostered in the generation side, thus allowing increased interconnection of generating units to the utility networks. These generating sources are called distributed generators (DG) and defined as the plant which is directly connected to distribution network and is not centrally planned and dispatched. These are also called embedded or dispersed generation units. The rating of the DG systems can vary between few kW to as high as 100 MW. Various new types of distributed generator systems, such as microturbines and fuel cells in addition to the more traditional solar and wind power are creating significant new opportunities for the integration of diverse DG systems to the utility. Interconnection of these generators will offer a number of benefits such as improved reliability, power quality, efficiency, alleviation of system constraints along with the environmental benefits. Unlike centralized power plants, the DG units are directly connected to the distribution system; most often at the customer end. The existing distribution networks are designed and operated in radial configuration with unidirectional power flow from centralized generating station to customers. The increase in interconnection of DG to utility networks can lead to reverse power flow violating fundamental assumption in their design. This creates complexity in operation and control of existing distribution networks and offers many technical challenges for successful introduction of DG systems. Some of the technical issues are islanding of DG, voltage regulation, protection and stability of the network. Some of the solutions to these problems include designing standard interface control for individual DG systems by taking care of their diverse characteristics, finding new ways to/or install and control these DG systems and finding new design for distribution system. DG has much potential to improve distribution system performance. The use of DG strongly contributes to a clean, reliable and cost effective energy for future. This book deals with several aspects of the DG systems such as benefits, issues, technology interconnected operation, performance studies, planning and design. Several authors have contributed to this book aiming to benefit students, researchers, academics, policy makers and professionals. We are indebted to all the people who either directly or indirectly contributed towards the publication of this book.

How to reference

In order to correctly reference this scholarly work, feel free to copy and paste the following:

Edward Coster, Johanna Myrzik and Wil Kling (2010). Effect of DG on Distribution Grid Protection, Distributed Generation, D N Gaonkar (Ed.), ISBN: 978-953-307-046-9, InTech, Available from:

<http://www.intechopen.com/books/distributed-generation/effect-of-dg-on-distribution-grid-protection>

INTECH

open science | open minds

InTech Europe

University Campus STeP Ri
Slavka Krautzeka 83/A
51000 Rijeka, Croatia
Phone: +385 (51) 770 447
Fax: +385 (51) 686 166
www.intechopen.com

InTech China

Unit 405, Office Block, Hotel Equatorial Shanghai
No.65, Yan An Road (West), Shanghai, 200040, China
中国上海市延安西路65号上海国际贵都大饭店办公楼405单元
Phone: +86-21-62489820
Fax: +86-21-62489821

© 2010 The Author(s). Licensee IntechOpen. This chapter is distributed under the terms of the [Creative Commons Attribution-NonCommercial-ShareAlike-3.0 License](#), which permits use, distribution and reproduction for non-commercial purposes, provided the original is properly cited and derivative works building on this content are distributed under the same license.