

We are IntechOpen, the world's leading publisher of Open Access books Built by scientists, for scientists

6,900

Open access books available

186,000

International authors and editors

200M

Downloads

Our authors are among the

154

Countries delivered to

TOP 1%

most cited scientists

12.2%

Contributors from top 500 universities



WEB OF SCIENCE™

Selection of our books indexed in the Book Citation Index
in Web of Science™ Core Collection (BKCI)

Interested in publishing with us?
Contact book.department@intechopen.com

Numbers displayed above are based on latest data collected.
For more information visit www.intechopen.com



Progress Works of High and Super High Temperature Heat Pipes

Wei Qu

*Institute of Engineering Thermophysics, Chinese Academy of Sciences
North 4th Ring Road No.11, Beijing 100190
China*

1. Introduction

Heat pipe is a high efficiency heat transfer element, depends on the evaporation, condensation and circulation of inside working fluid. The good performance of a heat pipe is due to that the working fluid evaporation of latent heat is generally large, so there needs no much working fluid and the circulation flow rate is usually small, and the flow resistance is small, when a heat pipe works. The temperature and pressure inside a heat pipe are nearly at uniform levels through the evaporator to the condenser, so a heat pipe has a high heat transfer ability at smaller temperature difference. The heat pipe has many other advantages, such as the heat fluxes of evaporator and condenser can be changed easily by adjusting the heat transfer lengths and areas etc..

The working fluid of a high temperature heat pipe is generally alkali metals, and their evaporations of latent heat are very large, and the saturation pressure is smaller at high temperature, then the case strength is not a problem. The high and super high temperature heat pipe can work over 500°C, 1000°C, 1500°C or much higher. Sodium heat pipe can operate during 500~1100°C, and lithium heat pipe can work over 1200°C (Ma et al, 1983). The high and super high temperature heat pipes have wide applications in space thermal control, solar storage power plant, nuclear thermal control, the constant industry stoves etc.. Usually, the heat pipes between 500~1100°C use the sodium as working fluid, they are called as the high temperature heat pipe; while the heat pipes over 1200°C, utilize lithium as the working fluid, they are named as the super high temperature heat pipes. Commonly, 1000°C can be supposed to divide the boundary of high and super high temperature heat pipes.

The first heat pipe in China was made in 1972, those stainless steel and sodium heat pipes realized the high temperature stove to make the semiconductor technology reliable. As shown in figure 1, the super high temperature heat pipe of W-Li by USA was tested in 1966 (Busse, 1992). The basic parameters and the startup process were given beside the figure, different temperature level tells the performances of the lithium heat pipe.

For the nuclear reactor cooled by the high temperature heat pipes, the fuel bars and the high temperature heat pipes are designed to be coupled together. By the high temperature heat pipes, the heat from the pile core is transferred to the heat exchanger, the technology of high temperature thermal radiation is realized (Zhang et al, 2009). The high temperature heat pipes connect the nuclear power suppliers to the outside and transfer the large amount of

heat. When the space nuclear power suppliers work at full, the temperature of heat core can reach 3000~3300K, however, the maximum temperature to be controlled is 800K. So, the high temperature heat pipe is the key problem to be solved for the whole system. Such aspect relates also the miniaturization, and performance optimum of the high temperature heat pipe, and the shape adaptability and coupling with the high temperature radiator etc..

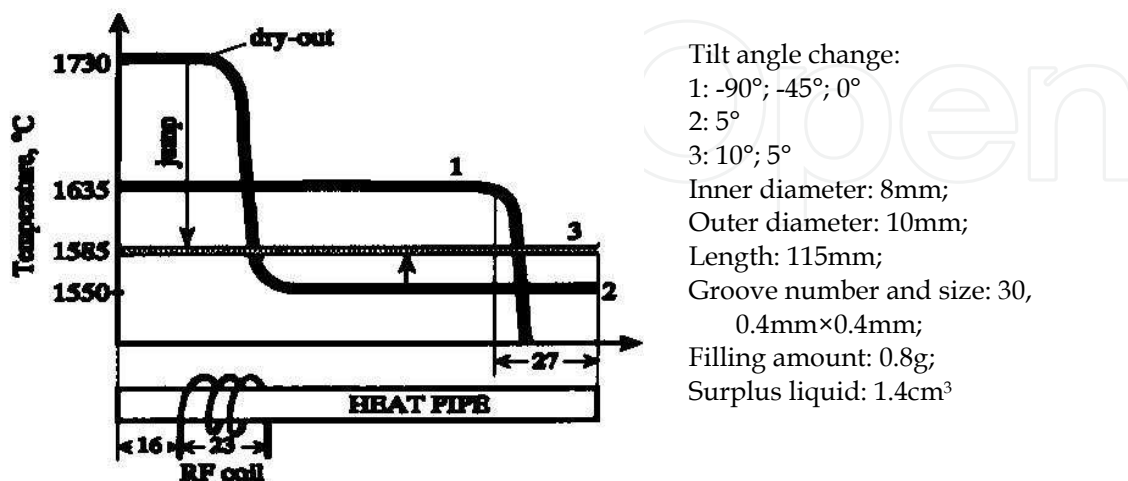

Fig. 1. Temperature levels of W-Li heat pipes when the heat flux is kept constant (Busse, 1992)

For the past few decades, the sodium and lithium heat pipes were developed a lot. There were different application in many fields as, the thermal control of super high Mach spacecraft, the heat storage and heat transfer of solar power plant, the heat recycling and application of high temperature gas discharge, the thermal control in nuclear energy, the constant temperature of industry stove, etc., in some situations, they are necessary and cannot be realized by other ways.

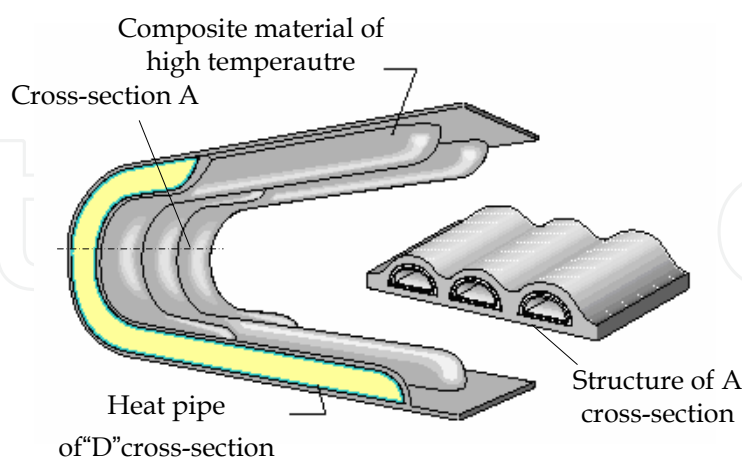

Fig. 2. Heat protection of high temperature heat pipe(by NASA) (David et al, 1998)

For the super high Mach spacecraft, the conduction heat protection is a kind of initiative method to realize thermal control, it is different from the heat protection of conventional surface ablation, or by the new material enduring much higher temperature level (Boman et al, 1990), as shown in figure 2. The "D" shape high temperature heat pipes were bended to

couple the outside composite material of high temperature. During flight, the friction heat at cross-section A outside the cover will be conducted to the non-stagnant point of the cover by heat pipe. So the temperature of the stagnant points can be kept at lower level (Faghri et al, 1992, David et al, 1998).

There will be large aerodynamic heat at the leading edge of the flying supersonic aircraft and space shuttle due to the friction between the super high Mach flight and the ambience, especially for the stagnation point (Jiang et al, 2008).

In this chapter, the progress works of the high temperature and super high temperature heat pipes are summed up. Owing to the different levels of temperature and pressure, the strength of the heat pipe shell, the compatibility of material and wick should be considered and designed. Generally, the working fluid is solid, there will be startup problem, the startup is analyzed. The heat transfer limits are important to the heat pipe operation, the possible limitations of high and super high temperature heat pipes are calculated and discussed. The technology is the key problem to realize the high performance heat pipe, the distillation and non-distillation methods are introduced. At last, the technology development of heat pipe is introduced.

2. The compatibility of case material and working fluid

Because the material of high temperature is generally dense, and the fabricating of heat pipe will guarantee the welding connection to have enough thickness and strength, the eligible welding, it is not supposed to occur the reported "sodium and water reaction" (Zhuang et al, 1998,2000). For the failure of high temperature heat pipe, firstly, the purity of material and cleansing belong to the treatment method, no problem to be controlled, then, the real problem turns to the key cause of the compatibility (Jacobson et al, 1984).

When the metal contacts the ambient medium, the metal erosion may occur due to the chemical reaction and electrochemistry. The erosion mechanism of alkali metal heat pipe is important to take measures to keep the performance of high temperature heat pipes and reliability.

2.1 The high temperature micro cell erosion

The erosions of oxidation and dissolution are introduced a lot in some reports or books (Ma et al, 1984; Zhuang et al, 1998; Zhang et al, 1987; Jacobson et al, 1984). Here, there are two points to be emphasized. (1) For the outside of the heat pipe, if the ambient oxygen concentration is significant, the heat pipe surface will be oxidized directly, the higher temperature is, the much more erodible is the surface. However, if a dense layer of oxides is formed, the existence of oxide will increase the anti-erosion ability of the outside surface. However, if there is a little alkali produced, they will dissolve the protection layer of the base metal, then the reaction will be increased. (2) For the inside of the heat pipe, some components of the composite metal may also dissolve in the liquid alkali metal. The inner surface will form rust speckles, so the effective thickness of the heat pipe wall is decreased. The alkali metal evaporates continuously, the dissolved speckles will deposit and jam up the liquid flow passages. The failure reason is liquid return resistance is increased a lot instead of wall metal consumption.

Here, another important erosion is put forward, it is the most possible in high and super high temperature heat pipes. The components and purity of metal are important for the

selection of material. The metal in liquid working fluid is easy to be erodible due to electrochemistry (Li et al, 1987). The reason is, the metal of industry purity contains the impurity material, and they have higher electricity potential. When they contact the liquid working fluid, there form many micro cathodes on the metal surface. The metal of lower electricity potential becomes the anodes. Then there are many many micro cells to make the metal erodible. For higher temperature level, such erosion is very remarkable, they are called the micro cell erosion.

The micro cell erosion belongs to a kind of the electrochemistry erosion. Such process consists of three parts. Firstly, the metal is dissolved to be erodible on anodes, the oxidation reaction occurs. Secondly, the electrons flow from anodes to cathodes. Thirdly, the electron flow is accepted by the material in the working fluids, the deoxidization reaction occurs on cathodes. For the cathodes, there are many kinds of material on cathodes, such as micro amount of H⁺ and O₂ etc.. This is the main reason to select and treat the working fluids to be purified.

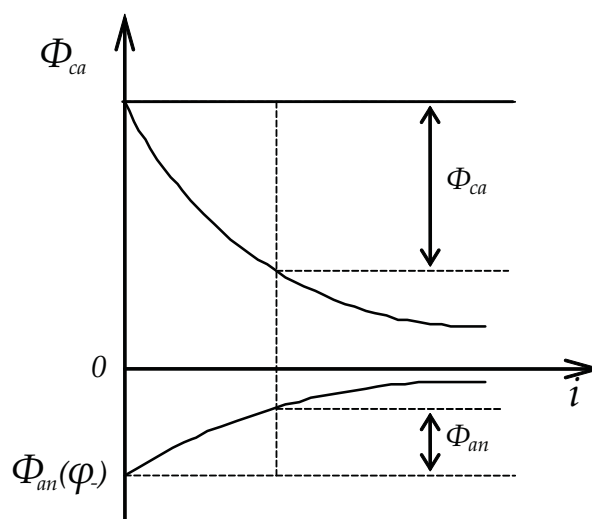

Fig. 3. Schematic of polarized curve for electrochemistry erosion of micro cell

The value of electrode potential stands for the activity of a metal. If " φ " expresses the electrode potential at arbitrary concentration, " i " is the electricity current, the polarization curve is shown in figure 3, the curve can help to denote the electrode reaction. Generally for the anodes, the metal will lose the electrons and become the positive ionic, the polarization is lower; while for the cathodes, the polarization is higher due to the vapor and (or) gas.

Generally, there are two reasons to trigger the micro cell erosion. One is that, the inner resistance of the erodible cells will increase with the amount of the hardly dissolved salts, and the erosion electricity decreases continuously, then the erosion speed is decreased. The other is that, the erosion cells are polarized, and the electromotive potential is decreased.

In summary, increasing the inner resistance and polarization of the erosion micro cells, the erosion speed will decrease. In addition, the higher erosion characteristics relates with the impurity quantity and the surface smoothness. The more impurity quantity is, the worse anti-erosion is; the smoother is the surface, the better anti-erosion is.

The impurity with higher electricity potential in a metal, or the contact with the metal of higher electricity potential will increase the erosion. So the impurity rate and the cleanness process, fabrication process etc. should be paid attention essentially for the high and super high temperature heat pipes.

2.2 The property and strength of high temperature alloy

Table 1 and 2 list the physical and mechanical properties of some high temperature alloys.

material	melting point(°C)	density(kg/m ³)	highest operating temperature(°C)
GH3030	1374~1420	8.40	800
GH128	1340~1390	8.81	950
SS304	1454	7.85	800
Inconel600	1354~1413	8.47	1093

Table 1. Physical properties

material	Test temp.(°C)	pull properties			Enduring strength (MPa)	Enduring time (h)
		Anti-pull strength σ_b (MPa)	Yielding strength $\sigma_{0.2}$ (MPa)	Elongating rate δ_s (%)		
GH3030	20	730	—	44	—	—
	700	266	—	72	103	100
GH128	20	891	350	54	—	—
	950	198	—	99	42	100
SS304	20	520	205	40	—	—
	—	—	—	—	—	—
Inconel600	20	671	246	41	—	—
	1093	—	—	—	9.7	100

Table 2. Mechanical properties

The heat pipe shell strength is considered during operation. The heat pipe shell strength is calculated by (GB 9222-88, 1988),

$$b_{wa} = \frac{PD_{in}}{2[\sigma]} \quad (1)$$

The most pressure of the heat pipe shell is derived as,

$$P = \frac{b_{wa} 2[\sigma]}{D_{in}} \quad (2)$$

In equation (2), P is the inner pressure of the heat pipe; D_{in} expresses the inner diameter of the heat pipe; b_{wa} is the thickness of the thinnest wall; $[\sigma]$ is the permitted stress.

The end cap strength is checked by the most permitted pressure, i.e. the gauge pressure as,

$$P = \frac{S_y 2[\sigma] \varphi}{YD_n + S_y} \quad (3)$$

In equation (3), S_y is the effective thickness of the end cap wall, the weakening coefficient of the end cap is $\varphi=0.9$, D_n is the diameter of the heat pipe end cap. The shape coefficient Y is calculated by,

$$Y = \frac{1}{6} \left[2 + \left(\frac{D_n}{2h_n} \right)^2 \right] \quad (4)$$

In equation (4), h_n is the highness inside the heat pipe end cap.

For the material of GH128, the pull strength is 850MPa at room temperature. While at temperature 1000°C, the yielding strength is 350MPa; the pull strength is 140MPa, the extension rate is 85%. And at this temperature, the enduring life is 200 hours at 30MPa, the extension rate is 40%. For the operating temperature of 1000°C, the heat pipe shell and end cap have the lowest pull strength and yielding strength, the inside alkali metal vapor pressure is the highest. So, if the worst situation can satisfy the demand, then the lower temperature can also meet the strength demand. The explosion coefficient is set 2.0, the yielding coefficient is given as 1.5, the calculated results are shown in table 3. By the results, the design can meet the strength demands.

	Inner groove height (mm)	[σ] (MPa)	Enduring most pressure shell/end cap (MPa)	Enduring most pressure of end, shell/end cap (MPa)	Vapor pressure (MPa)
$\phi 8 \times 1$	0.5	70	10/2.86	15.75/4.5	2.71
$\phi 8 \times 2$	0.5	70	23/6.67	31.50/9.0	2.71

Table 3. The strength of high temperature heat pipe GH128-Na (1000°C)

2.3 The material selection of super high temperature heat pipe

For the situations of coupling the heat pipe and the outside material, the expanding characteristics of both them at operating higher temperatures can lead to the thermal stress due to the material distortion. If this problem is not considered, the crevice between the heat pipe and the outside material can worsen the heat transfer. The linear expanding coefficients of some high temperature materials are listed by table 4.

material	20~100°C	20~400°C	20~600°C	20~800°C	20~1000°C
GH3030	12.8	15	16.1	17.5	—
GH128	11.2	12.8	13.7	15.2	16.3
304	18.2	—	—	—	—
Inconel600	13.3	14.5	15.3	16.1	—

Table 4. Linear expanding coefficient ($10^{-6}/^{\circ}\text{C}$)

In order to decrease the crevice between the heat pipe and the outside material, the material niobium is the best candidate, owing to its smallest linear expanding coefficient. Niobium belongs to the VB list in the chemistry element periodic table. Its melting point is 2468°C, the strength is high during 1093~1427°C. Its thermal expanding coefficient is $7.2 \times 10^{-6}/^{\circ}\text{C}$, the density is similar to the steel, the strength can be kept at 1649.9°C, and it can endure a certain mechanical deformation. Niobium is stable in eroding medium, and has good thermal conductivity. Based on the good performance of physical and chemical properties, the niobium base alloys are best candidate for the super high temperature heat pipes. However, such alloy has lower anti-oxidization. As shown in figure 4, the niobium bars and strips are products by a certain company.

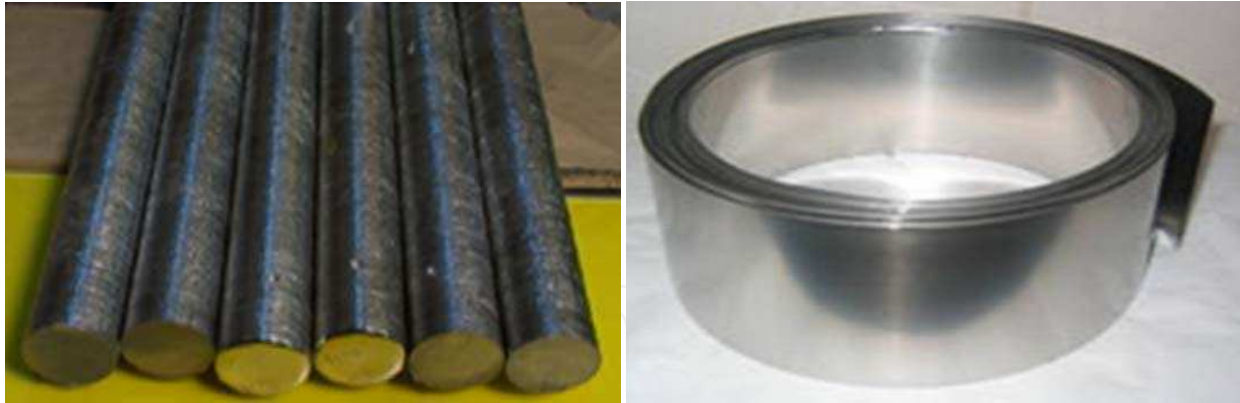

Fig. 4. Niobium sticks and straps, made by a certain company

For the heat leading problem of super Mach flight, the used heat pipes need to be coupled with the outside material. The thermal expanding coefficients of both them should be considered. The contact thermal resistance due to crevice by the different expanding can fail the heat leading design.

2.4 Alkali metal lithium

Alkali metals are commonly used to be the working fluid of high and super high temperature heat pipes, such as lithium, sodium, potassium, and their alloy. There are many advantages to select alkali metals. Alkali metals can work at high temperature, they have high latent heat of vaporization, they have stable characteristics and lower saturation vapor pressure and good thermal conductivity.

At room temperature, alkali metals are solid states. They will be oxidized in air. So the heat pipe filling process should keep them from contacting the air. Additionally, the purity of alkali metals should be guaranteed to fill the heat pipe, there is no other oxidization.

For the lithium, the obtained physical, thermodynamic properties, the erosion property etc. are extremely not consistent, especially for the high temperature situations. The experimental results are different for researchers, the tentative explanations can be owing to the different purity of lithium materials. The other reason may be due to the different accuracies used. The key reason may be that the lithium is not purified carefully before filling. Additionally, lithium is active to react with some impurities. The impurities have very effects on the properties.

Lithium is the lightest metal. Its density is from 0.531~0.534g/cm³, it can be believed to be 0.533g/cm³. The melting point is from 179~186 °C, it can be supposed to be 180.5±0.1°C. The saturation pressure of solid and liquid lithium (P_s and P_l , Pa) can be obtained by theory and experiments (Gelishen, 1966). Between the temperature $T=298\sim 453.7\text{K}$, there is,

$$\lg(P_s/133.3) = 14.2121 - \frac{8551.18}{T} - 3.79295 \lg T + 6.7167 \times 10^{-3} T \quad (5)$$

If the temperature $T=453.7\sim 1350\text{K}$, then the relation is,

$$\lg(P_l/133.3) = 10.1184 - \frac{8442.53}{T} - 1.64098 \lg T + 2.5968 \times 10^{-4} T \quad (6)$$

The simple equation of saturation pressure of liquid lithium is as,

$$\lg(P_l/133.3) = 8.0 - \frac{8143}{T} \quad (7)$$

When the temperature is between 700~1400 K, equation (7) coincides with equation (6).

2.5 The compatibility

Eliminating the fabrication factors, the compatibility of high and super high temperature heat pipes are due to the micro cell erosions, the shell and wick materials dissolve in the working fluids. In addition, the micro cell erosion can make the inner surface be granulating erosion and make the shell wall thinner. The temperature level will influence the compatibility essentially. Busse found that for tungsten and rhenium alloy-lithium heat pipe, the heat pipe longevity is several years, one year and one month respectively, corresponding to the temperatures 1600°C, 1700°C and 1800°C (Busse 1992). The effects of temperature level to the longevity are very obvious.

Table 5 shows the general results of compatibility, this is the basic principle to select the couple of shell material and alkali metal.

	SS	Ni	Ni alloy	W	Ta	Mo	Re	Ti	Nb
Lithium	×	×	×	√	√	√	√	×	√
Sodium	√	√	√	—	—	—	—	×	√

√: compatibility tested; ×: non-compatibility tested

Table 5. General results of compatibility

3	4	5	6	7	8	9	10	11	12
3B	4B	5B	6B	7B	8B			1B	2B
21 Sc Scandium 44.96	22 Ti Titanium 47.87	23 V Vanadium 50.94	24 Cr Chromium 52.00	25 Mn Manganese 54.94	26 Fe Iron 55.85	27 Co Cobalt 58.93	28 Ni Nickel 58.69	29 Cu Copper 63.55	30 Zn Zinc 65.39
39 Y Yttrium 88.91	40 Zr Zirconium 91.22	41 Nb Niobium 92.91	42 Mo Molybdenum 95.94	43 Tc Technetium (98)	44 Ru Ruthenium 101.07	45 Rh Rhodium 102.91	46 Pd Palladium 106.42	47 Ag Silver 107.87	48 Cd Cadmium 112.41
57 La Lanthanum 138.91	72 Hf Hafnium 178.49	73 Ta Tantalum 180.95	74 W Tungsten 183.84	75 Re Rhenium 186.21	76 Os Osmium 190.23	77 Ir Iridium 192.22	78 Pt Platinum 195.08	79 Au Gold 196.97	80 Hg Mercury 200.59
89 Ac Actinium (227)	104 Rf Rutherfordium (261)	105 Db Dubnium (262)	106 Sg Seaborgium (266)	107 Bh Bohrium (264)	108 Hs Hassium (269)	109 Mt Meitnerium (268)			

Fig. 5. Positions on element periodic table of materials suitable for super high temperature heat pipes

Considering all the important factors, the high temperature material, the above mentioned micro cell erosion, high temperature alloy properties, the compatibility with the alkali metals, and the experimental results, figure 5 gives the selected heat pipe materials, signed as "ellipse" in the chemistry element periodic table. From 4B~7B rows, tungsten, tantalum, molybdenum, rhenium and niobium are good candidates to the high and super high temperature heat pipes.

In the mean time, the material selection should consider the material machining properties and availability, the price and other factors.

3. Startup analysis of alkali metal heat pipe

For alkali metal heat pipes, commonly, the working fluid in heat pipes is solid state. The heat transfer into the evaporator make the solid working fluid melt, then one equivalent heating section is formed. If the heat pipe is started up by heating one end, such as the heat pipe has only one end heating section for the high mach stagnant point. As shown in figure 6, when the solid working fluid is melted completely the temperature distribution along the heat pipe is given.

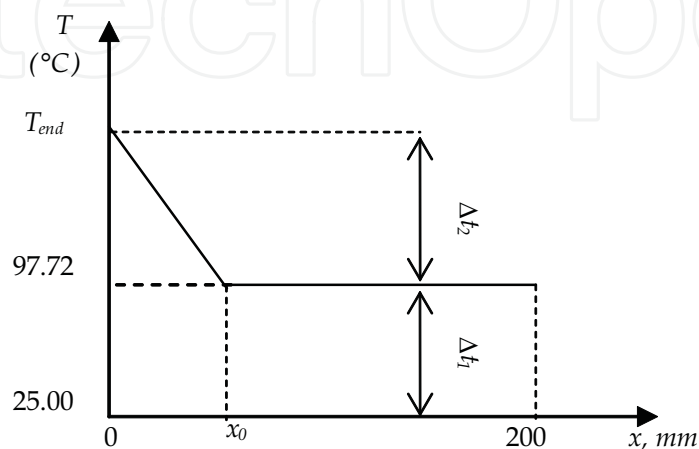

Fig. 6. Temperature distribution along the heat pipe when the solid working fluid is melted completely

For one concrete high temperature heat pipe, the cross-section area is 0.7536cm^2 . At 700°C , the thermal conductivity of heat pipe shell material is $25\text{W}/(\text{m}\cdot^\circ\text{C})$. If the startup power is 50W , the axial temperature difference will reach $26^\circ\text{C}/\text{mm}$ by Fourier law. Obviously, there will be bigger temperature difference along the axial direction. When the heat pipe is started up, if the melted working fluid is not enough to make all the solid working fluid melt wholly, then the startup will fail. In order to control the highest temperature of the stagnant point, the heat applied should be lower than one level.

3.1 Analysis of startup time

For the horizontal sodium heat pipe, the ambience temperature is 25°C , then the sodium is solid before startup. Between the temperature range $25\sim 97^\circ\text{C}$, the thermal conductivity and the heat capacity of sodium are considered as constants. And from 25°C to 800°C , the heat pipe shell is taken as constant. The axial conduction of the wick is ignored.

The sodium should be heated to melt completely, from room temperature 25°C to the melting point 97.72°C . The solid working fluid inside heat pipe is assumed to distribute uniformly. The thermal capacity of the heat pipe is $C_{tube}=53\text{J}/\text{K}$, the thermal capacity of the working fluid is $C_{Na}=3.14\text{J}/\text{K}$. For the sodium, the melting latent heat is $L_{melt}=113\text{kJ}/\text{kg}$, the latent heat of evaporation is $h_{fg}=4215\text{kJ}/\text{kg}$. The heat to evaporate the working fluid should be large than that, the heat to increase the temperature to the melting point and the heat to melt the solid working fluid completely in the condenser, there is,

$$W_1 = h_{fg} m \frac{x}{200} = \left(1 - \frac{x}{200}\right) [(C_{tube} + C_{Na}) \Delta T_1 + mL_{melt}] \quad (8)$$

When the solid working fluid melt wholly, the temperature distribution is given in figure 4. ΔT_1 is the temperature difference between the melting point to the room temperature. x_0 is the needed length to evaporate the working fluid. For the given sodium heat pipe A without groove, $x_0 = 58.6\text{mm}$; while for the heat pipe B with groove, $x_0 = 33.24\text{mm}$ by equation (8). It is assumed that there is no heat transfer between the heat pipe condenser and the ambience. Then the startup heat transfer is estimated as,

$$W_2 = (C_{tube} + C_{Na})\Delta T_1 + mL_{melt} + \frac{x}{200}C_{tube}\frac{\Delta T_2}{2} \quad (9)$$

$\Delta T_2/2$ is the mean temperature difference between the evaporator temperature and the sodium melting point.

For the evaporator, there is only the axial conduction along the heat pipe shell. The heat transfer rate is given by Fourier law as

$$Q = -\lambda A dT/dx \quad (10)$$

Considering equations (8) and (10), the relation between the input power and the end temperature can be obtained. The startup time is given also by equation (8) and (10) as,

$$t = W_2/Q \quad (11)$$

3.2 Results of startup time

From the data of the sodium melting heat with pressure and temperature, it is known that the melting point changes little with the pressure. The melting point and melting heat are taken for one standard atmosphere pressure to calculate the startup time. The startup power should be controlled not to exceed one value, which can make the evaporator dryout before all the solid working fluid is melted completely.

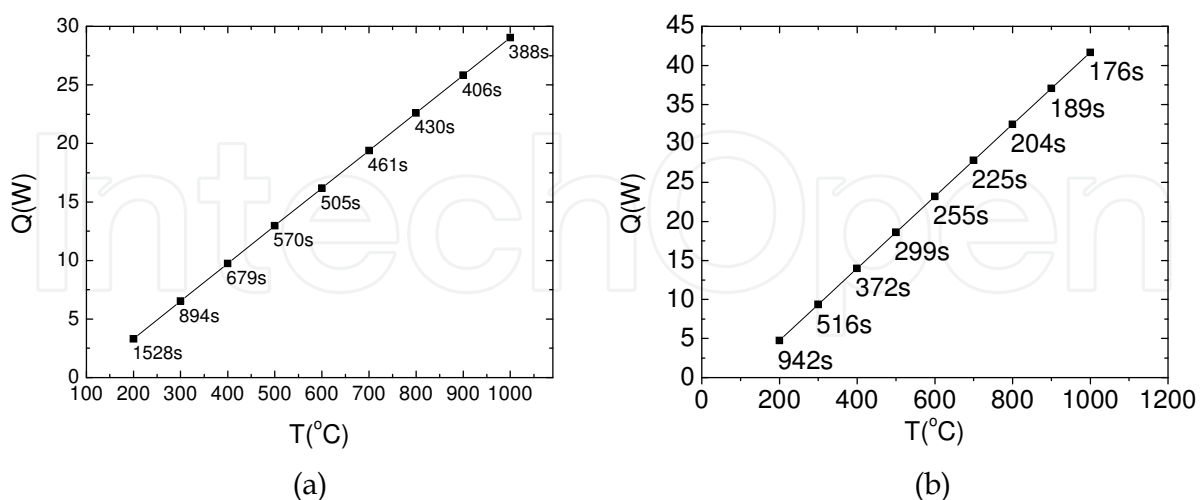

Fig. 7. Relations of heat transfer rate, startup time and temperature. (a) with screen wick, without groove (b) with screen wick and with grooves

For the sodium heat pipe A and B, the results are shown in figure 7. At the same startup heat transfer rate, 20W, the startup time of A and B is 450S and 290S respectively.

4. Technology control of alkali metal heat pipe

The performance of heat pipe depends on the fabrication technology. The charging process should guarantee the vacuum level before filling. The working fluid quantity charged should be controlled. The working fluid has enough purity, the oxidization and impurities are at the endurable levels, the seal is soldered and guaranteed etc..

4.1 The vacuum level control

Commonly, if the pressure is less one atmosphere, 1.01×10^5 Pa, the vacuum is divided by several regions, as shown in table 6 (Zhang et al,1987).

Region	Pressure (Pa)	Density of molecule number, $n(\text{cm}^{-3})$	Mean free journey, $\lambda(\text{cm})$
Little vacuum	$1.01 \times 10^5 \sim 10^3$	$\sim 10^{18}$	10^{-4}
Low vacuum	$10^3 \sim 10^{-1}$	$\sim 10^{15}$	10^{-1}
High vacuum (HV)	$10^{-1} \sim 10^{-6}$	$\sim 10^{10}$	10^3
Super high vacuum (UHV)	$10^{-6} \sim 10^{-12}$	$\sim 10^6$	10^9
Extreme high vacuum (XHV)	$< 10^{-12}$	$< 10^2$	$> 10^{12}$

Table 6. The vacuum region partitions

For the high and super high temperature heat pipes, the vacuum region had better reach the levels of HV, if the vacuum is UHV or XHV, the technology will last long and the cost is increased a lot. If the vacuum is little or low, then the heat pipes have worse performances as shown in figure 8.



Fig. 8. The heat pipes have worse performances if the vacuums was low

4.2 The distillation technology

The distillation technology can make the alkali metal melt and evaporate. By controlling the temperature of distillation, the alkali metal is purified a lot, then the liquid alkali metal is charged into the candidate heat pipe. Such method keeps the system to be active vacuum, the vacuum equipment works continuously. This can keep the alkali metal purity, not to be oxidized by a little leakage air.

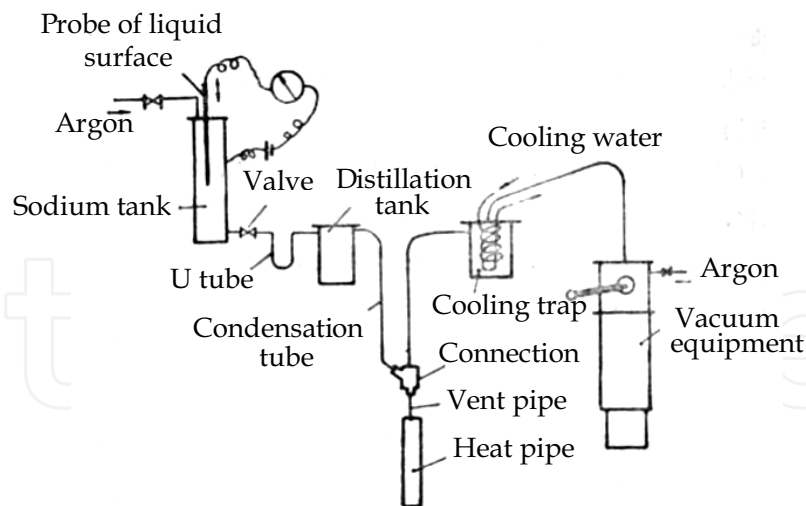

Fig. 9. Distillation technology of high temperature heat pipe

As shown in figure 9, the charging system consists of sodium tank, U tube, distillation tank, connection, cooling trap and vacuum equipment. The argon can protect the alkali metal in the sodium tank. The charging process includes two steps. Firstly, the set amount of alkali metal is filled from the sodium tank to the distillation tank. Secondly, the alkali metal is distilled and charged into the heat pipe.

For sodium, after pumping the system and the vacuum is permitted, the distillation tank is heated to a certain temperature, in the mean time the other part of the system has different temperature, such as, the outlet of the condensation tube should be controlled between 150~200°C. The much higher temperature can make sodium vapor be pumped into the vacuum equipment. The much lower temperature will lead to the higher viscosity of liquid sodium, then the small vent pipe can be jammed. Based on the same reasons, the connections, heat pipe, especially for the vent pipe also should be heated to about 200°C. After the other parts of the system reach the set temperature, the distillation tank is heated to a temperature between 480~500°C, and this temperature is kept constant to distill the sodium. The temperatures at every part are monitored. If the sodium is vaporized totally, the temperature of distillation tank will increase a lot, then stop heating the distillation tank.

Obviously, the distillation technology is complicated a little, and the consumptions of time, water and power are large. Once, only one heat pipe can be charged. And the after-treatment is also complicated, the sodium remains in the tubes are hard to be cleaned up.

4.3 The non-distillation technology

In order to make the charging process simple and several or many heat pipes can be filled simultaneously, the three-path-equipment of alkali metal charging was invented. As shown in figure 10.

The non-distillation charging system is composed of the vacuum equipment, the transparent glove chamber with argon protection, the valves of super high vacuum and tubes. There are three paths, can realize three alkali metal heat pipes charging simultaneously. For example, the flange of the first path is disconnected, the empty lower tank is put downward into the transparent glove chamber with argon protection. Also, the heat pipe end is inserted into one small tube, by which the air is replaced by argon. In this glove chamber, the alkali metal is cut, weighed and put into the tank, which outlet is set stainless steel screen. Then the tank with alkali metal is lifted to couple the flange and the system is closed by bolts and valves.

During this process, the main tube of the system is also blown by argon. The system is pumped some time, and the argon in the system is evacuated as much as possible. Here it is pointed out that the argon in the heat pipe is pumped out through the tank of alkali metal, the argon will cross the alkali metal by the aperture passage. By the bypass designed near the outlet of the alkali metal tank, the vacuum of heat pipe can be increased a lot.

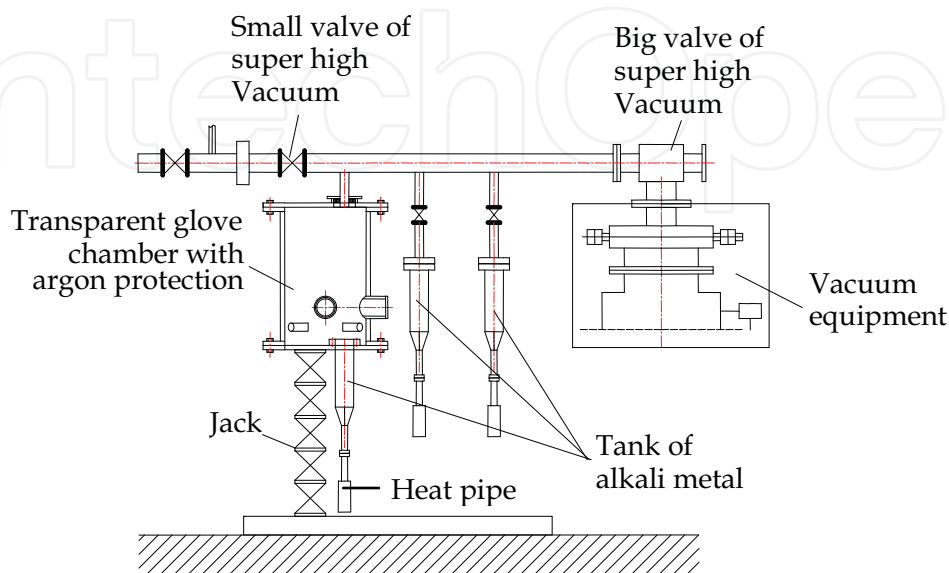

Fig. 10. Non-distillation technology of alkali metal heat pipe



Fig. 11. Three-path-equipment of alkali metal charging (figure 10)

After that, the alkali metal tank, the lower connection and the heat pipe is heated by the outside heaters. The temperature can reach 150~160°C or so for sodium. If the alkali metal inside is melted completely, then the big valve of high vacuum is closed, the pump equipment is cut off. The small valve of high vacuum is opened and the argon will push the alkali metal into the heat pipe. Then the small valve is closed and the big valve is opened. The system is evacuated again to a high vacuum level. Finally, the heat pipe is sealed by a special plier, soldered by a welder. A heat pipe is charged successfully. Figure 11 is the photo of three-path-equipment.

4.4 The technology monitoring

The monitor equipment of technology is shown in figure 12. The power increase can be set to heaters. The thermal couples and resistances are connected to the equipment. The computer and the inserted instruments are two-level system. The computer, digital instruments, controllable silicon, switches, contactors, buttons etc., are installed into the instrumental cabinet. By the computer, the technology process can be realized.



Fig. 12. Monitor equipment of heat pipe technology

The instruments and the sensors are connected to collect data and control the process. By the RS485 communication bus, the computer can display the process on time, the interface is displayed by Chinese. The data can be stored in the computer.

The performance of heat pipe depends on the process technology essentially.

5. Experimental results of alkali metal heat pipes

5.1 Startup from ambience

The startup experiments can test the heat pipe performance before the heat pipe is applied. As shown in figure 11(a), the evaporator is heated by high frequency heater, the heat pipe is set inside the high frequency loops, and the thermocouples are set along the condenser, which is in the ambient air. By the high frequency heater, the heat flux can be very large, and the some dryout point may be displayed by thermocouples.

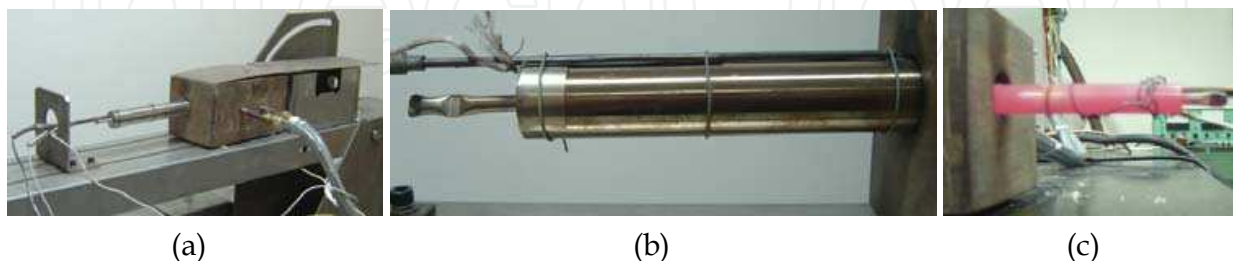

Fig. 13. Test rig of alkali metal heat pipe and startup photos of sodium heat pipes. (a) Test rig of heat pipe (b) Startup experiment, 5° anti-gravity (c) Startup, horizontal

The experimental photos are shown in figure 13 (b) and (c). By the color of the condenser, the sodium heat pipe can be started up successfully. The color is uniform along the condenser, the isothermal performance of the heat pipes are good. The purity of working

fluid and the high vacuum technology can guarantee that there is no noncondensable gas in the fabricated heat pipes.

As in figure 14, temperatures of three condenser points are demonstrated for horizontal position. For about 100S, the heat pipe can be started up. For 10 degree tilt angle, the evaporator is set lower, the results of sodium heat pipe startup is shown in figure 15. For another power step, the heat pipe performance is also satisfied.

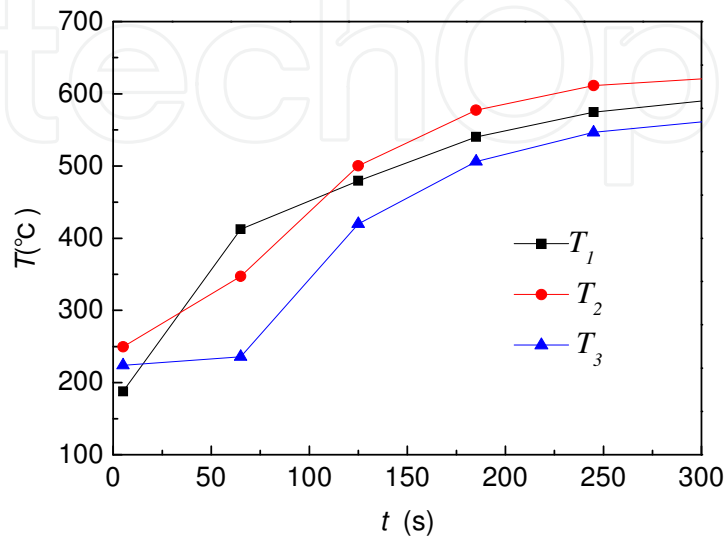

Fig. 14. Startup of horizontal sodium heat pipe

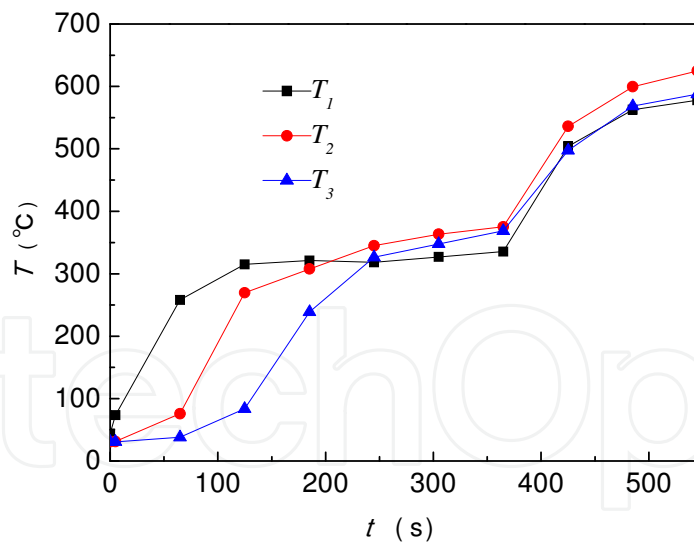

Fig. 15. Startup and power increased test of 10° degree tilt angle

5.2 Experiments in wind tunnel of electricity arc

By the high and super high temperature heat pipes, the local higher heat flux is moved to the lower heat flux region, the heat is moved from the “peak point” to the “valley region” by heat pipe, then the highest temperature is decreased a lot.

In a wind tunnel of electricity arc, three heat transfer elements as CC material, high conduction CC material and heat pipes are tested and compared, as shown in figure 16.

From figure 16, after 1200s, the heat pipe is started up successfully. The operation lasts nearly 5 minutes.

The upper three curves are the temperature histories of the stagnant points. The temperature of heat pipe stagnant point is lower than the other CC and high conduction CC elements, 120°C and 50°C lower respectively. The heat pipe behaves good performance.

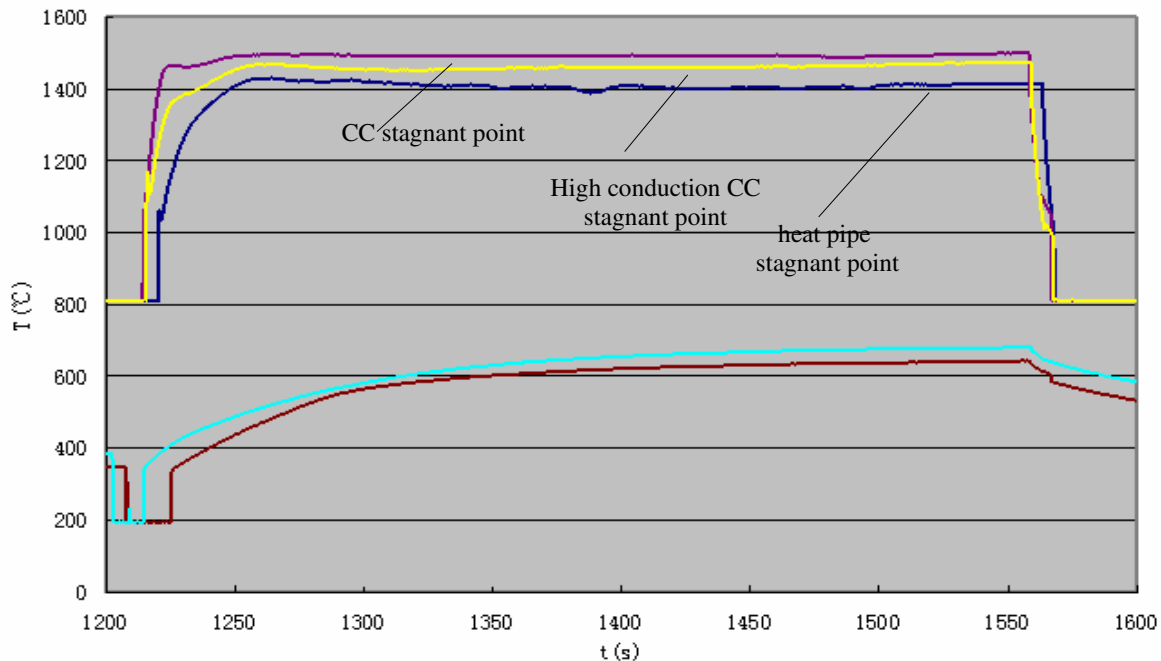

Fig. 16. Experimental temperatures of different method by arc tunnel heating (By China Academy 11)

6. Limits of alkali metal heat pipes

6.1 Continuum flow limit

With the decreasing of dynamic diameter, the heat pipe vapor flow may transit from the continuum flow to the free molecule flow. The continuum limit can be judged by the Knudsen number as,

$$Kn = \frac{\lambda}{D} \quad (12)$$

Here, λ is the free length of molecules, D is the minimum size of the vapor flow in heat pipe. If $Kn \leq 0.01$, the flow is continuum; if $Kn > 0.01$, the flow belongs to the free molecules. For the latter situation, the heat pipe may lose its performance.

Cao and Faghri derived the transition temperature as (Faghri, 1992),

$$T_{tr} = \frac{P_0}{\rho_{tr} R_g} \exp \left[-\frac{h_{fg}}{R_g} \left(\frac{1}{T_{tr}} - \frac{1}{T_0} \right) \right] \quad (13)$$

Substitute $Kn=0.01$ into equation (13), the transition temperature can be obtained.

As shown in figure 17, for sodium heat pipe, change of transition temperature with the dynamic diameter is given. If the dynamic diameter is decreased less than 1mm, the

continuum limit occurs. The transition temperature will increase with decreasing the diameter. When the dynamic diameter is $50\mu\text{m}$, the transition temperature will be 830°C . This temperature is in the range of normal temperature $500\sim 1100^\circ\text{C}$. Such results mean that the heat pipe will work at much higher temperature than the designed, in the mean time, the heat transfer rate decreases.

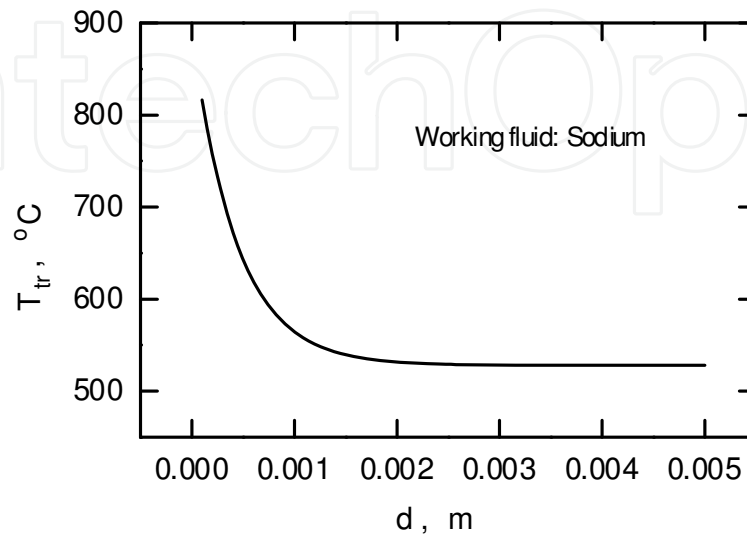

Fig. 17. For sodium heat pipes, change of transition temperature with the dynamic diameter

6.2 Other possible limits

When the alkali metal heat pipes are started up from low temperature, the vapor density is very small. The viscous resistance may dominate (Ma et al, 1983). At the end of the condenser, the vapor pressure decreases to extreme low, nearly zero. Then the viscous limit is reached as,

$$Q_{vis} = \frac{D_v^2 L}{64 \mu_v l_{eff}} \rho_{v,o} P_{v,o} \quad (14)$$

If the alkali metal heat pipes operate at low vapor pressure, the vapor density is small and the velocity is big, then the sonic velocity may choke the heat transfer, the sonic limit is expressed as,

$$Q_s = 0.474 L A_v \sqrt{\rho_{v,o} P_{v,o}} \quad (15)$$

When the vapor flow can entrain the liquid, the inertial force is bigger enough, the entrainment limit is given as,

$$Q_E = A_v \sqrt{2 \pi \sigma \rho_v L^2 / \lambda} \quad (16)$$

The capillary limit can be calculated by,

$$Q_{cap} = 2 \left(\frac{\sigma \rho_l L}{\mu_l} \right) \left(\frac{K A_w}{r_e l_{eff}} \right) \quad (17)$$

The basic heat transfer limits are given in figure 18 for sodium heat pipe. If the temperature is lower than 500°C, the sonic limit should be paid attention. When the temperature is between 500°C and 900°C, the entrainment limit is easy to occur, the temperature 700°C corresponds to 756W, then the heat flux is 246W/cm².

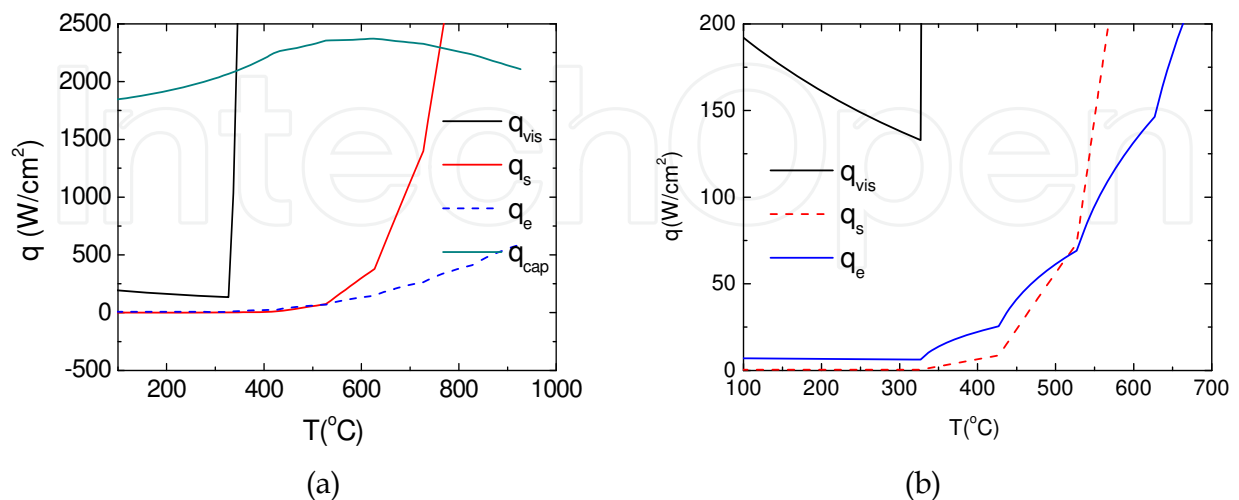

Fig. 18. Four limits of sodium heat pipes with temperature, (b) is the detail of local (a)

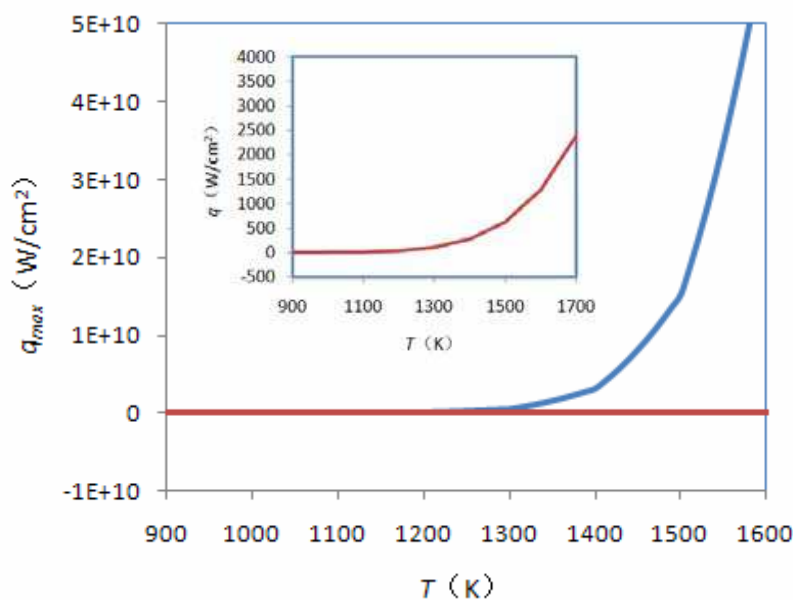

Fig. 19. Viscous and sonic limits of lithium heat pipe

The viscous and sonic limits of lithium heat pipes are illustrated in figure 19. The bottom line stands for the sonic limit. The details are also shown in the figure. From the results, the lithium should work at higher temperature and higher heat flux.

7. Chemical vapor deposit technology

The new material and new technology for high and super high temperature heat pipes are developed in recent years. There are some new technologies about alkali metal heat pipes.

Here the chemical vapor deposition (CVD) is introduced (Fortini, et al, 2010). The CVD method can be used to fabricate the heat pipes, the number of wicking grooves, their location, the cross-sectional shape, and the overall geometry of the heat pipe are easily varied. The integral grooves also eliminate the need for screens, thus allowing for greater design flexibility. Figure 20 shows the process schematically. The manufacturing process starts with a mandrel whose outer contour matches the desired inner contour of the finished product. For a heat pipe with a simple circular cross section, a tubular mandrel can be used to define the vapor channel, and smaller rods can be attached to the mandrel to define the liquid return arteries. After assembling the mandrel, the part is coated by CVD. The final step is etching away by mandrel with acid.

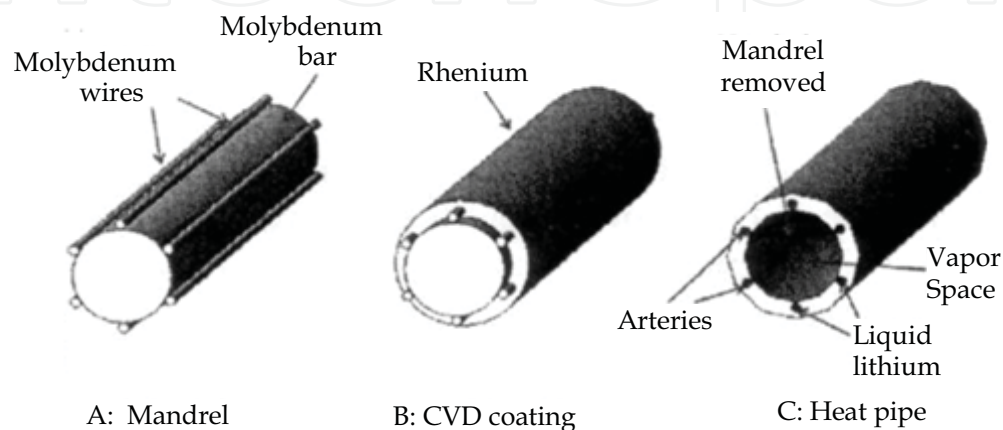

Fig. 20. Schematic of heat pipe fabrication process by chemical vapor deposition (Fortini, et al., 2010)

The advantage of CVD is that the grooves are incorporated into the machining grooves into the pipe wall after the pipe itself is fabricated. It also provides excellent flexibility in that it enables any number of grooves to be incorporated into the heat pipe. Furthermore, the grooves don't have to be evenly spaced; they can be concentrated on one side or the other if desired. Screens can be used in conjunction with the arteries at the evaporator end to further delocalize the liquid. Also, because CVD is not a line-of-sight process, the cross section of the heat pipe can be of virtually any geometry. It is not limited to straight heat pipes, nor is it limited to pipes of circular symmetry. Finally, for heat pipes that are reasonably straight, multiple pipes can be fabricated simultaneously.

Another benefit of CVD manufacturing is that multiple materials can be used to fabricate the pipe. For example, rhenium was chosen because of its chemical compatibility with lithium, ductility, and strength at high temperature. Rhenium, however, is expensive. To reduce the amount of rhenium used, one could apply a thin film of rhenium to the mandrel and then switch to say tantalum. Tantalum is extremely ductile and is more than an order of magnitude less expensive than rhenium. Tantalum also has good strength at high temperature, though not as good as rhenium. So even though a somewhat thicker layer of tantalum would be needed over the initial thin film of rhenium, the material cost would be reduced by more than a factor of 10.

8. Summings-up

In this chapter, the progress works of high and super high temperature heat pipes are introduced. The micro cell erosion mechanism to the high temperature heat pipe case and

the compatibility are given, the selections of the case material and the working fluid should be coupled to satisfy with the compatibility. The technology is the key problem to realize a high performance heat pipe, the alkali metal distillation and non-distillation technology are innovated, and the technology monitor is important for fabrication. Generally the working fluid is solid before high and super high temperature heat pipe startups, the startup possibility and time are analyzed and experimented. The heat transfer should be designed much smaller than those of the operating limits, the possible heat transfer limits of high and super high temperature heat pipes are calculated and discussed. The experimental and theoretical results show that the fabricated heat pipes have good performances. The new CVD methods can be used to fabricate the heat pipes, the integral grooves also eliminate the need for screens, thus allowing for greater design flexibility.

9. References

- Ma T. Z., Hou Z.Q. and Wu G.W. (1983). *Heat Pipe* (in Chinese), Science Press, pp.277-282, ISBN 7-03-002011-1
- Busse C.A. (1992). Heat Pipe Science, Advances in Heat Pipe Science and Technology, *Proc. of 8th Int. Heat Pipe Conference*, pp.3-8, Beijing, Int. Academic Publishers
- Zhang J.X. and Ning X.W. (2009). Study of Thermal Control Technology on Space Reactor Power Supplier (in Chinese), *Proc. of 9th China Space Thermophysics Conference*, pp.1-5, Beijing
- Boman B.L., et al. (1990). Heat Pipes for Wing Leading Edges of Hypersonic Vehicles, NASA CP-181922
- Faghri A. and Cao Y. (1992). Numerical Analysis of Leading Edge and Nosecap Heat Pipes, Advances in Heat Pipe Science and Technology, Int. Academic Publishers, pp.303-308, *Proc. of 8th Int. Heat Pipe Conference*, Beijing
- David E. Glas.(1998). Closed Form Equations for the Preliminary Design of a Heat Pipe-Cooled Leading Edge, NASA CR-1998-208962
- Jiang G.Q., Ai B.C., Yu J. J., Chen L.Z. (2008). Application of high temperature heat pipe in the protection technology of heat conduction (in Chinese), pp.74-80, *Proc. of 11th China Heat Pipe Conference*, Weihai, China
- Zhuang J. and Zhang H.(2000). *Heat Pipe Technology and Engineering Application*, pp.166-173, Chemical Industry Press
- Zhuang J. and Zhang G.Y.(1998). Sodium and water reaction in sodium heat pipe, pp.151-155, *Proc. of 6th China Heat Pipe Conference*, Wuyishan, China
- Jacobson D.L. and Wang J.H.(1984). Failure Analysis of a Sodium, Inconel 617 Heat Pipe, Preprints of Proceedings of 5th Heat Pipe Conference, Tsukuba, Japan, 121-125
- Zhang S.H. and Shen H.J. (1987), *Molecule Physics and Thermodynamics*, Beijing Science and Technology Press, pp.75-76, ISBN7-5304-0023-1/Z
- Jacobson D.L. and Soundararajan P.(1984). Failure Analysis of a Sodium Heat Pipe with Integral Lithium Fluoride Thermal Energy Storage, pp.115-120, Preprints of Proc. of 5th Heat Pipe Conference, Tsukuba, Japan
- Li T.H. and Hua C.S. (1987). *Heat Pipe Design and Application* (in Chinese), pp.102-108, Chemical Industry Press
- GB 9222-88 (1988). Strength Calculation of Pressure Parts for Water-tube Boilers, pp.1-72, National Standards Press of China
- Gelishen, Gejizunuofu (Russian accent) et al. (1966). Properties of Lithium (Interpretation from Russian) , pp.10-12, China Industry Press
- Fortini A.J., Arrieta V.M. (2010). Rhenium Heat Pipes for Hypersonic Leading Edges, Preprints of 15th Int. Heat Pipe Conference, pp.1-6, Clemson, USA

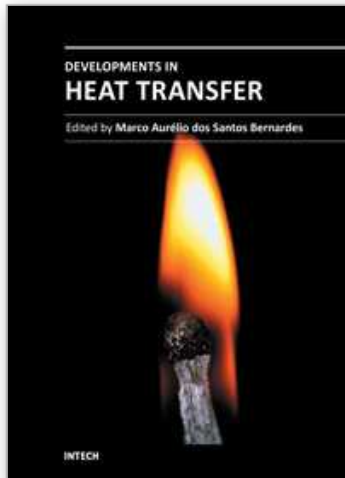

Developments in Heat Transfer

Edited by Dr. Marco Aurelio Dos Santos Bernardes

ISBN 978-953-307-569-3

Hard cover, 688 pages

Publisher InTech

Published online 15, September, 2011

Published in print edition September, 2011

This book comprises heat transfer fundamental concepts and modes (specifically conduction, convection and radiation), bioheat, entransy theory development, micro heat transfer, high temperature applications, turbulent shear flows, mass transfer, heat pipes, design optimization, medical therapies, fiber-optics, heat transfer in surfactant solutions, landmine detection, heat exchangers, radiant floor, packed bed thermal storage systems, inverse space marching method, heat transfer in short slot ducts, freezing and drying mechanisms, variable property effects in heat transfer, heat transfer in electronics and process industries, fission-track thermochronology, combustion, heat transfer in liquid metal flows, human comfort in underground mining, heat transfer on electrical discharge machining and mixing convection. The experimental and theoretical investigations, assessment and enhancement techniques illustrated here aspire to be useful for many researchers, scientists, engineers and graduate students.

How to reference

In order to correctly reference this scholarly work, feel free to copy and paste the following:

Wei Qu (2011). Progress Works of High and Super High Temperature Heat Pipes, Developments in Heat Transfer, Dr. Marco Aurelio Dos Santos Bernardes (Ed.), ISBN: 978-953-307-569-3, InTech, Available from: <http://www.intechopen.com/books/developments-in-heat-transfer/progress-works-of-high-and-super-high-temperature-heat-pipes>

INTECH
open science | open minds

InTech Europe

University Campus STeP Ri
Slavka Krautzeka 83/A
51000 Rijeka, Croatia
Phone: +385 (51) 770 447
Fax: +385 (51) 686 166
www.intechopen.com

InTech China

Unit 405, Office Block, Hotel Equatorial Shanghai
No.65, Yan An Road (West), Shanghai, 200040, China
中国上海市延安西路65号上海国际贵都大饭店办公楼405单元
Phone: +86-21-62489820
Fax: +86-21-62489821

© 2011 The Author(s). Licensee IntechOpen. This chapter is distributed under the terms of the [Creative Commons Attribution-NonCommercial-ShareAlike-3.0 License](#), which permits use, distribution and reproduction for non-commercial purposes, provided the original is properly cited and derivative works building on this content are distributed under the same license.

IntechOpen

IntechOpen